

**ANNEX I**  
**SUMMARY OF PRODUCT CHARACTERISTICS**

## 1. NAME OF THE MEDICINAL PRODUCT

Biopoin 1,000 IU/0.5 ml solution for injection in pre-filled syringe  
Biopoin 2,000 IU/0.5 ml solution for injection in pre-filled syringe  
Biopoin 3,000 IU/0.5 ml solution for injection in pre-filled syringe  
Biopoin 4,000 IU/0.5 ml solution for injection in pre-filled syringe  
Biopoin 5,000 IU/0.5 ml solution for injection in pre-filled syringe  
Biopoin 10,000 IU/1 ml solution for injection in pre-filled syringe  
Biopoin 20,000 IU/1 ml solution for injection in pre-filled syringe  
Biopoin 30,000 IU/1 ml solution for injection in pre-filled syringe

## 2. QUALITATIVE AND QUANTITATIVE COMPOSITION

### Biopoin 1,000 IU/0.5 ml solution for injection in pre-filled syringe

One pre-filled syringe contains 1,000 international units (IU) (8.3 µg) epoetin theta in 0.5 ml solution for injection corresponding to 2,000 IU (16.7 µg) epoetin theta per ml.

### Biopoin 2,000 IU/0.5 ml solution for injection in pre-filled syringe

One pre-filled syringe contains 2,000 international units (IU) (16.7 µg) epoetin theta in 0.5 ml solution for injection corresponding to 4,000 IU (33.3 µg) epoetin theta per ml.

### Biopoin 3,000 IU/0.5 ml solution for injection in pre-filled syringe

One pre-filled syringe contains 3,000 international units (IU) (25 µg) epoetin theta in 0.5 ml solution for injection corresponding to 6,000 IU (50 µg) epoetin theta per ml.

### Biopoin 4,000 IU/0.5 ml solution for injection in pre-filled syringe

One pre-filled syringe contains 4,000 international units (IU) (33.3 µg) epoetin theta in 0.5 ml solution for injection corresponding to 8,000 IU (66.7 µg) epoetin theta per ml.

### Biopoin 5,000 IU/0.5 ml solution for injection in pre-filled syringe

One pre-filled syringe contains 5,000 international units (IU) (41.7 µg) epoetin theta in 0.5 ml solution for injection corresponding to 10,000 IU (83.3 µg) epoetin theta per ml.

### Biopoin 10,000 IU/1 ml solution for injection in pre-filled syringe

One pre-filled syringe contains 10,000 international units (IU) (83.3 µg) epoetin theta in 1 ml solution for injection corresponding to 10,000 IU (83.3 µg) epoetin theta per ml.

### Biopoin 20,000 IU/1 ml solution for injection in pre-filled syringe

One pre-filled syringe contains 20,000 international units (IU) (166.7 µg) epoetin theta in 1 ml solution for injection corresponding to 20,000 IU (166.7 µg) epoetin theta per ml.

### Biopoin 30,000 IU/1 ml solution for injection in pre-filled syringe

One pre-filled syringe contains 30,000 international units (IU) (250 µg) epoetin theta in 1 ml solution for injection corresponding to 30,000 IU (250 µg) epoetin theta per ml.

Epoetin theta (recombinant human erythropoietin) is produced in Chinese Hamster Ovary Cells (CHO-K1) by recombinant DNA technology.

For the full list of excipients, see section 6.1.

## 3. PHARMACEUTICAL FORM

Solution for injection (injection).

The solution is clear and colourless.

## 4. CLINICAL PARTICULARS

### 4.1 Therapeutic indications

- Treatment of symptomatic anaemia associated with chronic renal failure in adult patients.
- Treatment of symptomatic anaemia in adult cancer patients with non-myeloid malignancies receiving chemotherapy.

### 4.2 Posology and method of administration

Epoetin theta treatment should be initiated by physicians experienced in the above-mentioned indications.

#### Posology

##### *Symptomatic anaemia associated with chronic renal failure*

Anaemia symptoms and sequelae may vary with age, gender, and overall burden of disease; a physician's evaluation of the individual patient's clinical course and condition is necessary. Epoetin theta should be administered either subcutaneously or intravenously in order to increase haemoglobin level to not greater than 12 g/dl (7.45 mmol/l).

Due to intra-patient variability, occasional individual haemoglobin values for a patient above and below the desired haemoglobin level may be observed. Haemoglobin variability should be addressed through dose management, with consideration for the haemoglobin target range of 10 g/dl (6.21 mmol/l) to 12 g/dl (7.45 mmol/l). A sustained haemoglobin level of greater than 12 g/dl (7.45 mmol/l) should be avoided; guidance for appropriate dose adjustment if haemoglobin values exceeding 12 g/dl (7.45 mmol/l) are observed are described below.

A rise in haemoglobin of greater than 2 g/dl (1.24 mmol/l) over a four week period should be avoided. If the rise in haemoglobin is greater than 2 g/dl (1.24 mmol/l) in 4 weeks or the haemoglobin value exceeds 12 g/dl (7.45 mmol/l), the dose should be reduced by 25 to 50%. It is recommended that haemoglobin be monitored every two weeks until levels have stabilised and periodically thereafter. If the haemoglobin level continues to increase, therapy should be interrupted until the haemoglobin level begins to decrease, at which point therapy should be restarted at a dose approximately 25% below the previously administered dose.

In the presence of hypertension or existing cardiovascular, cerebrovascular or peripheral vascular diseases, the increase in haemoglobin and the target haemoglobin value should be determined individually taking into account the clinical picture.

Treatment with epoetin theta is divided into two stages.

#### Correction phase

Subcutaneous administration: The initial posology is 20 IU/kg body weight 3 times per week. The dose may be increased after 4 weeks to 40 IU/kg, 3 times per week, if the increase in haemoglobin is not adequate (< 1 g/dl [0.62 mmol/l] within 4 weeks). Further increases of 25% of the previous dose may be made at monthly intervals until the individual target haemoglobin level is obtained.

Intravenous administration: The initial posology is 40 IU/kg body weight 3 times per week. The dose may be increased after 4 weeks to 80 IU/kg, 3 times per week, and by further increases of 25% of the previous dose at monthly intervals, if needed.

For both routes of administration, the maximum dose should not exceed 700 IU/kg body weight per week.

#### Maintenance phase

The dose should be adjusted as necessary to maintain the individual target haemoglobin level between 10 g/dl (6.21 mmol/l) to 12 g/dl (7.45 mmol/l), whereby a haemoglobin level of 12 g/dl (7.45 mmol/l) should not be exceeded. If a dose adjustment is required to maintain the desired haemoglobin level, it is recommended that the dose be adjusted by approximately 25%.

Subcutaneous administration: The weekly dose can be given as one injection per week or three times per week.

Intravenous administration: Patients who are stable on a three times weekly dosing regimen may be switched to twice-weekly administration.

If the frequency of administration is changed, haemoglobin level should be monitored closely and dose adjustments may be necessary.

The maximum dose should not exceed 700 IU/kg body weight per week.

If epoetin theta is substituted for another epoetin, haemoglobin level should be monitored closely and the same route of administration should be used.

Patients should be monitored closely to ensure that the lowest approved effective dose of epoetin theta is used to provide adequate control of the symptoms of anaemia whilst maintaining a haemoglobin concentration below or at 12 g/dl (7.45 mmol/l).

Caution should be exercised with escalation of epoetin theta doses in patients with chronic renal failure. In patients with a poor haemoglobin response to epoetin theta, alternative explanations for the poor response should be considered (see sections 4.4 and 5.1).

*Symptomatic anaemia in cancer patients with non-myeloid malignancies receiving chemotherapy*  
Epoetin theta should be administered by the subcutaneous route to patients with anaemia (e.g. haemoglobin concentration  $\leq$  10 g/dl [6.21 mmol/l]). Anaemia symptoms and sequelae may vary with age, gender, and overall burden of disease; a physician's evaluation of the individual patient's clinical course and condition is necessary.

Due to intra-patient variability, occasional individual haemoglobin values for a patient above and below the desired haemoglobin level may be observed. Haemoglobin variability should be addressed through dose management, with consideration for the haemoglobin target range of 10 g/dl (6.21 mmol/l) to 12 g/dl (7.45 mmol/l). A sustained haemoglobin level of greater than 12 g/dl (7.45 mmol/l) should be avoided; guidance for appropriate dose adjustment if haemoglobin values exceeding 12 g/dl (7.45 mmol/l) are observed are described below.

The recommended initial dose is 20,000 IU, independent of bodyweight, given once-weekly. If, after 4 weeks of therapy, the haemoglobin value has increased by at least 1 g/dl (0.62 mmol/l), the current dose should be continued. If the haemoglobin value has not increased by at least 1 g/dl (0.62 mmol/l) a doubling of the weekly dose to 40,000 IU should be considered. If, after an additional 4 weeks of therapy, the haemoglobin increase is still insufficient an increase of the weekly dose to 60,000 IU should be considered.

The maximum dose should not exceed 60,000 IU per week.

If, after 12 weeks of therapy, the haemoglobin value has not increased by at least 1 g/dl (0.62 mmol/l), response is unlikely and treatment should be discontinued.

If the rise in haemoglobin is greater than 2 g/dl (1.24 mmol/l) in 4 weeks or the haemoglobin level exceeds 12 g/dl (7.45 mmol/l), the dose should be reduced by 25 to 50%. Treatment with epoetin theta should be temporarily discontinued if haemoglobin levels exceed 13 g/dl (8.07 mmol/l). Therapy should be reinitiated at approximately 25% lower than the previous dose after haemoglobin levels fall to 12 g/dl (7.45 mmol/l) or below.

Therapy should be continued up to 4 weeks after the end of chemotherapy.

Patients should be monitored closely to ensure that the lowest approved dose of epoetin theta is used to provide adequate control of the symptoms of anaemia.

#### *Special populations*

##### Paediatric population

The safety and efficacy of Biopoin in children and adolescents aged up to 17 years have not yet been established. No data are available.

##### Method of administration

The solution can be administered subcutaneously or intravenously. Subcutaneous use is preferable in patients who are not undergoing haemodialysis, in order to avoid puncturing peripheral veins. If epoetin theta is substituted for another epoetin, the same route of administration should be used. In cancer patients with non-myeloid malignancies receiving chemotherapy epoetin theta should be administered by the subcutaneous route only.

Subcutaneous injections should be given into the abdomen, arm or thigh.

The injection sites should be rotated and the injection performed slowly to avoid discomfort at the site of injection.

For instructions on handling of the medicinal product before administration, see section 6.6.

### **4.3 Contraindications**

- Hypersensitivity to the active substance, other epoetins and derivatives or to any of the excipients listed in section 6.1.
- Uncontrolled hypertension.

### **4.4 Special warnings and precautions for use**

#### General

Supplementary iron therapy is recommended for all patients with serum ferritin values below 100 µg/l or with transferrin saturation below 20%. To ensure effective erythropoiesis, iron status has to be evaluated for all patients prior to and during treatment.

Non-response to therapy with epoetin theta should prompt a search for causative factors. Deficiencies of iron, folic acid or vitamin B<sub>12</sub> reduce the effectiveness of epoetins and should therefore be corrected. Intercurrent infections, inflammatory or traumatic episodes, occult blood loss, haemolysis, aluminium intoxication, underlying haematological diseases or bone marrow fibrosis may also compromise the erythropoietic response. A reticulocyte count should be considered as part of the evaluation.

#### Pure red cell aplasia (PRCA)

If typical causes of non-response are excluded, and the patient has a sudden drop in haemoglobin associated with reticulocytopenia, an examination of anti-erythropoietin antibodies and the bone marrow for diagnosis of pure red cell aplasia should be considered. Discontinuation of treatment with epoetin theta should be taken into account.

PRCA caused by neutralising anti-erythropoietin antibodies has been reported in association with erythropoietin therapy, including with epoetin theta. These antibodies have been shown to cross-react with all epoetins, and patients suspected or confirmed to have neutralising antibodies to erythropoietin should not be switched to epoetin theta (see section 4.8).

In order to improve the traceability of epoetins, the name of the administered epoetin should be clearly recorded in the patient file.

A paradoxical decrease in haemoglobin and development of severe anaemia associated with low reticulocyte counts should prompt to discontinue treatment with epoetin and perform anti-erythropoietin antibody testing. Cases have been reported in patients with hepatitis C treated with interferon and ribavirin, when epoetins are used concomitantly. Epoetins are not approved in the management of anaemia associated with hepatitis C.

#### Hypertension

Patients on epoetin theta therapy can experience an increase in blood pressure or aggravation of existing hypertension particularly during the initial treatment phase.

Therefore, in patients treated with epoetin theta, special care should be taken to monitor closely and control blood pressure. Blood pressure should be controlled adequately before initiation and during therapy to avoid acute complications, such as hypertensive crisis with encephalopathy-like symptoms (e.g. headaches, confused state, speech disturbances, impaired gait) and related complications (seizures, stroke), which may also occur in individual patients with otherwise normal or low blood pressure. If these reactions occur, they require the immediate attention of a physician and intensive medical care. Particular attention should be paid to sudden sharp migraine-like headaches as a possible warning signal.

Increases in blood pressure may require treatment with antihypertensive medicinal products or a dose increase of existing antihypertensive medicinal products. In addition, a reduction of the administered dose of epoetin theta needs to be considered. If blood pressure values remain high, temporary interruption of epoetin theta therapy may be required. Once hypertension has been controlled with more intensified therapy, epoetin theta therapy should be re-started at a reduced dose.

#### Misuse

Misuse of epoetin theta by healthy persons may lead to an excessive increase in haemoglobin and haematocrit. This may be associated with life-threatening cardiovascular complications.

#### Severe cutaneous adverse reactions

Severe cutaneous adverse reactions (SCARs) including Stevens-Johnson syndrome (SJS) and toxic epidermal necrolysis (TEN), which can be life-threatening or fatal, have been reported in association with epoetin treatment. More severe cases have been observed with long-acting epoetins.

At the time of prescription, patients should be advised of the signs and symptoms and monitored closely for skin reactions. If signs and symptoms suggestive of these reactions appear, epoetin theta should be withdrawn immediately and an alternative treatment considered.

If the patient has developed a severe cutaneous skin reaction such as SJS or TEN due to the use of epoetin theta, treatment with epoetin theta must not be restarted in this patient at any time.

#### Special populations

Due to limited experience, the efficacy and safety of epoetin theta could not be assessed in patients with impaired liver function or homozygous sickle cell anaemia.

In clinical trials, patients over 75 years of age had a higher incidence of serious and severe adverse events irrespective of a causal relationship to treatment with epoetin theta. Furthermore, deaths were more frequent in this patient group compared to younger patients.

#### Laboratory monitoring

It is recommended that haemoglobin measurement, a complete blood count and platelet count be performed regularly.

### Symptomatic anaemia associated with chronic renal failure

The use of epoetin theta in nephrosclerotic patients not yet undergoing dialysis should be defined individually, as a possible accelerated progression of renal failure cannot be ruled out with certainty.

During haemodialysis, patients treated with epoetin theta may require increased anticoagulation treatment to prevent clotting of the arterio-venous shunt.

In patients with chronic renal failure, the maintenance haemoglobin concentration should not exceed the upper limit of the target haemoglobin concentration recommended in section 4.2. In clinical trials, an increased risk of death and serious cardiovascular events was observed when epoetins were administered to target a haemoglobin level in excess of 12 g/dl (7.45 mmol/l). Controlled clinical trials have not shown significant benefits attributable to the administration of epoetins when the haemoglobin concentration is increased beyond the level necessary to control symptoms of anaemia and to avoid blood transfusion.

Caution should be exercised with escalation of epoetin theta doses in patients with chronic renal failure since high cumulative epoetin doses may be associated with an increased risk of mortality, serious cardiovascular and cerebrovascular events. In patients with a poor haemoglobin response to epoetins, alternative explanations for the poor response should be considered (see sections 4.2 and 5.1).

### Symptomatic anaemia in cancer patients with non-myeloid malignancies receiving chemotherapy

#### Effect on tumour growth

Epoetins are growth factors that primarily stimulate red blood cell production. Erythropoietin receptors may be expressed on the surface of a variety of tumour cells. As with all growth factors, there is a concern that epoetins could stimulate the growth of any type of malignancy (see section 5.1).

In several controlled studies, epoetins have not been shown to improve overall survival or decrease the risk of tumour progression in patients with anaemia associated with cancer. In controlled clinical studies, use of epoetins has shown:

- shortened time to tumour progression in patients with advanced head and neck cancer receiving radiation therapy when administered to target a haemoglobin level in excess of 14 g/dl (8.69 mmol/l),
- shortened overall survival and increased deaths attributed to disease progression at 4 months in patients with metastatic breast cancer receiving chemotherapy when administered to target a haemoglobin value of 12-14 g/dl (7.45-8.69 mmol/l),
- increased risk of death when administered to target a haemoglobin value of 12 g/dl (7.45 mmol/l) in patients with active malignant disease receiving neither chemotherapy nor radiation therapy.

Epoetins are not indicated for use in this patient population.

In view of the above, in some clinical situations blood transfusion should be the preferred treatment for the management of anaemia in patients with cancer. The decision to administer recombinant erythropoietins should be based on a benefit-risk assessment with the participation of the individual patient, which should take into account the specific clinical context. Factors that should be considered in this assessment should include the type of tumour and its stage, the degree of anaemia, life-expectancy, the environment in which the patient is being treated, and patient preference (see section 5.1).

### Excipients

This medicinal product contains less than 1 mmol sodium (23 mg) per pre-filled syringe, i.e. essentially 'sodium-free'.

## **4.5 Interaction with other medicinal products and other forms of interaction**

No interaction studies have been performed.

## **4.6 Fertility, pregnancy and lactation**

### Pregnancy

There are no or limited amount of data (less than 300 pregnancy outcomes) from the use of epoetin theta in pregnant women. Animal studies with other epoetins do not indicate direct harmful effects with respect to reproductive toxicity (see section 5.3). As a precautionary measure, it is preferable to avoid the use of Biopoin during pregnancy.

### Breast-feeding

It is unknown whether epoetin theta/metabolites are excreted in human milk, but data in neonates show no absorption or pharmacological activity of erythropoietin when given together with breast milk. A decision must be made whether to discontinue breast-feeding or to discontinue/abstain from Biopoin therapy taking into account the benefit of breast-feeding for the child and the benefit of therapy for the woman.

### Fertility

No data are available.

## **4.7 Effects on ability to drive and use machines**

Epoetin theta has no or negligible influence on the ability to drive and use machines.

## **4.8 Undesirable effects**

### Summary of the safety profile

Approximately 9% of patients can be expected to experience an adverse reaction. The most frequent adverse reactions are hypertension, influenza-like illness and headache.

### Tabulated list of adverse reactions

The safety of epoetin theta has been evaluated based on results from clinical studies including 972 patients.

Adverse reactions listed below in table 1 are classified according to System Organ Class. Frequency groupings are defined according to the following convention:

Very common:	$\geq 1/10$ ;
Common:	$\geq 1/100$ to $< 1/10$ ;
Uncommon:	$\geq 1/1,000$ to $< 1/100$ ;
Rare:	$\geq 1/10,000$ to $< 1/1,000$ ;
Very rare:	$< 1/10,000$ ;
Not known:	cannot be estimated from the available data.



<i>Table 1: Adverse reactions</i>			
<i>System organ class</i>	<i>Adverse reaction</i>	<i>Frequency</i>	
		<i>Symptomatic anaemia associated with chronic renal failure</i>	<i>Symptomatic anaemia in cancer patients with non-myeloid malignancies receiving chemotherapy</i>
<i>Blood and lymphatic system disorders</i>	Pure red cell aplasia (PRCA)*	Not known	—
<i>Immune system disorders</i>	Hypersensitivity reactions	Not known	
<i>Nervous system disorders</i>	Headache	Common	
<i>Vascular disorders</i>	Hypertension*	Common	
	Hypertensive crisis*	Common	—
	Shunt thrombosis*	Common	—
	Thromboembolic events	—	Not known
<i>Skin and subcutaneous tissue disorders</i>	Skin reactions*	Common	
<i>Musculoskeletal and connective tissue disorders</i>	Arthralgia	—	Common
<i>General disorders and administration site conditions</i>	Influenza-like illness*	Common	

\*See subsection “Description of selected adverse reactions” below

#### Description of selected adverse reactions

In patients with chronic renal failure, neutralising anti-erythropoietin antibody-mediated pure red cell aplasia (PRCA) associated with epoetin theta therapy has been reported in post marketing setting. If PRCA is diagnosed, therapy with epoetin theta must be discontinued and patients should not be switched to another recombinant epoetin (see section 4.4).

One of the most frequent adverse reactions during treatment with epoetin theta is an increase in blood pressure or aggravation of existing hypertension particularly during the initial treatment phase. Hypertension occurs in chronic renal failure patients more often during the correction phase than during the maintenance phase. Hypertension can be treated with appropriate medicinal products (see section 4.4).

Hypertensive crisis with encephalopathy-like symptoms (e.g. headaches, confused state, speech disturbances, impaired gait) and related complications (seizures, stroke) may also occur in individual patients with otherwise normal or low blood pressure (see section 4.4).

Shunt thrombosis may occur, especially in patients who have a tendency to hypotension or whose arterio-venous fistulae exhibit complications (e.g. stenoses, aneurisms) (see section 4.4).

Skin reactions such as rash, pruritus or injection site reactions may occur.

Severe cutaneous adverse reactions (SCARs) including Stevens-Johnson syndrome (SJS) and toxic epidermal necrolysis (TEN), which can be life-threatening or fatal, have been reported in association with epoetin treatment (see section 4.4).

Symptoms of influenza-like illness such as fever, chills and asthenic conditions have been reported.

### Reporting of suspected adverse reactions

Reporting suspected adverse reactions after authorisation of the medicinal product is important. It allows continued monitoring of the benefit/risk balance of the medicinal product. Healthcare professionals are asked to report any suspected adverse reactions via the national reporting system listed in [Appendix V](#).

## **4.9 Overdose**

The therapeutic margin of epoetin theta is very wide. In the case of overdose, polycythaemia can occur. In the event of polycythaemia, epoetin theta should be temporarily withheld.

If severe polycythaemia occurs, conventional methods (phlebotomy) may be indicated to reduce the haemoglobin level.

## **5. PHARMACOLOGICAL PROPERTIES**

### **5.1 Pharmacodynamic properties**

Pharmacotherapeutic group: Other antianemic preparations, ATC code: B03XA01

#### Mechanism of action

Human erythropoietin is an endogenous glycoprotein hormone that is the primary regulator of erythropoiesis through specific interaction with the erythropoietin receptor on the erythroid progenitor cells in the bone marrow. It acts as a mitosis-stimulating factor and differentiation hormone. The production of erythropoietin primarily occurs in and is regulated by the kidney in response to changes in tissue oxygenation. Production of endogenous erythropoietin is impaired in patients with chronic renal failure and the primary cause of their anaemia is erythropoietin deficiency. In patients with cancer receiving chemotherapy the aetiology of anaemia is multifactorial. In these patients, erythropoietin deficiency and a reduced response of erythroid progenitor cells to endogenous erythropoietin both contribute significantly towards their anaemia.

Epoetin theta is identical in its amino acid sequence and similar in its carbohydrate composition (glycosylation) to endogenous human erythropoietin.

#### Preclinical efficacy

The biological efficacy of epoetin theta has been demonstrated after intravenous and subcutaneous administration in various animal models *in vivo* (mice, rats, dogs). After administration of epoetin theta, the number of erythrocytes, the haematocrit values and reticulocyte counts increase.

#### Clinical efficacy and safety

##### *Symptomatic anaemia associated chronic renal failure*

Data from correction phase studies in 284 chronic renal failure patients show that the haemoglobin response rates (defined as haemoglobin levels above 11 g/dl at two consecutive measurements) in the epoetin theta group (88.4% and 89.4% in studies in patients on dialysis and not yet undergoing dialysis, respectively) were comparable to epoetin beta (86.2% and 81.0%, respectively). The median time to response was similar in the treatment groups with 56 days in haemodialysis patients and 49 days in patients not yet undergoing dialysis.

Two randomised controlled studies were conducted in 270 haemodialysis patients and 288 patients not yet undergoing dialysis, who were on stable treatment with epoetin beta. Patients were randomised to continue their current treatment or to be converted to epoetin theta (same dose as epoetin beta) in order to maintain their haemoglobin levels. During the evaluation period (weeks 15 to 26), the mean and median level of haemoglobin in patients treated with epoetin theta was virtually identical to their baseline haemoglobin level. In these two studies, 180 haemodialysis patients and 193 patients not undergoing dialysis were switched from maintenance phase treatment with epoetin beta to treatment with epoetin theta for a period of six months showing stable haemoglobin values and a similar safety

profile as epoetin beta. In the clinical studies, patients not yet undergoing dialysis (subcutaneous administration) discontinued the study more frequently than haemodialysis patients (intravenous administration) as they had to terminate the study when starting dialysis.

In two long-term studies, the efficacy of epoetin theta was evaluated in 124 haemodialysis patients and 289 patients not yet undergoing dialysis. The haemoglobin levels remained within the desired target range and epoetin theta was well tolerated over a period of up to 15 months.

In the clinical studies, pre-dialysis patients were treated once-weekly with epoetin theta, 174 patients in the maintenance phase study and 111 patients in the long-term study.

Pooled post-hoc analyses of clinical studies of epoetins have been performed in chronic renal failure patients (on dialysis, not on dialysis, in diabetic and non-diabetic patients). A tendency towards increased risk estimates for all-cause mortality, cardiovascular and cerebrovascular events associated with higher cumulative epoetin doses independent of the diabetes or dialysis status was observed (see sections 4.2 and section 4.4).

*Symptomatic anaemia in cancer patients with non-myeloid malignancies receiving chemotherapy*  
409 cancer patients receiving chemotherapy were included in two prospective, randomised double-blind, placebo-controlled studies. The first study was conducted in 186 anaemic patients with non-myeloid malignancies (55% with haematological malignancies and 45% with solid tumours) receiving non-platinum chemotherapy. The second study was conducted in 223 patients with various solid tumours receiving platinum-containing chemotherapy. In both studies, treatment with epoetin theta resulted in a significant haemoglobin response ( $p < 0.001$ ), defined as an increase in haemoglobin of  $\geq 2$  g/dl without transfusion, and a significant reduction in transfusion requirements ( $p < 0.05$ ) in comparison to placebo.

#### *Effect on tumour growth*

Erythropoietin is a growth factor that primarily stimulates red cell production. Erythropoietin receptors may be expressed on the surface of a variety of tumour cells.

Survival and tumour progression have been examined in five large controlled studies involving a total of 2,833 patients, of which four were double-blind placebo-controlled studies and one was an open-label study. Two of the studies recruited patients who were being treated with chemotherapy. The target haemoglobin concentration in two studies was  $> 13$  g/dl; in the remaining three studies it was 12-14 g/dl. In the open-label study there was no difference in overall survival between patients treated with recombinant human erythropoietin and controls. In the four placebo-controlled studies the hazard ratios for overall survival ranged between 1.25 and 2.47 in favour of controls. These studies have shown a consistent unexplained statistically significant excess mortality in patients who have anaemia associated with various common cancers who received recombinant human erythropoietin compared to controls. Overall survival outcome in the trials could not be satisfactorily explained by differences in the incidence of thrombosis and related complications between those given recombinant human erythropoietin and those in the control group.

Data from three placebo-controlled clinical studies in 586 anaemic cancer patients conducted with epoetin theta, showed no negative effect of epoetin theta on survival. During the studies, mortality was lower in the epoetin theta group (6.9%) compared to placebo (10.3%).

A systematic review has also been performed involving more than 9,000 cancer patients participating in 57 clinical trials. Meta-analysis of overall survival data produced a hazard ratio point estimate of 1.08 in favour of controls (95% CI: 0.99, 1.18; 42 trials and 8,167 patients). An increased relative risk of thromboembolic events (RR 1.67, 95% CI: 1.35, 2.06; 35 trials and 6,769 patients) was observed in patients treated with recombinant human erythropoietin. There is therefore consistent evidence to suggest that there may be significant harm to patients with cancer who are treated with recombinant human erythropoietin. The extent to which these outcomes might apply to the administration of recombinant human erythropoietin to patients with cancer, treated with chemotherapy to achieve

haemoglobin concentrations less than 13 g/dl, is unclear because few patients with these characteristics were included in the data reviewed.

A patient-level data analysis has also been performed on more than 13,900 cancer patients (chemo-, radio-, chemoradio- or no therapy) participating in 53 controlled clinical trials involving several epoetins. Meta-analysis of overall survival data produced a hazard ratio point estimate of 1.06 in favour of controls (95% CI: 1.00, 1.12; 53 trials and 13,933 patients) and for cancer patients receiving chemotherapy, the overall survival hazard ratio was 1.04 (95% CI: 0.97, 1.11; 38 trials and 10,441 patients). Meta-analyses also indicate consistently a significantly increased relative risk of thromboembolic events in cancer patients receiving recombinant human erythropoietin (see section 4.4).

## **5.2 Pharmacokinetic properties**

### General

The pharmacokinetics of epoetin theta have been examined in healthy volunteers, in patients with chronic renal failure and in cancer patients receiving chemotherapy. The pharmacokinetics of epoetin theta are independent of age or gender.

### Subcutaneous administration

Following subcutaneous injection of 40 IU/kg body weight epoetin theta at three different sites (upper arm, abdomen, thigh) in healthy volunteers, similar plasma level profiles were observed. The extent of absorption (AUC) was slightly greater after injection in the abdomen in comparison to the other sites. The maximum concentration is reached after an average of 10 to 14 hours and the average terminal half-life ranges from approximately 22 to 41 hours.

Average bioavailability of epoetin theta after subcutaneous administration is approximately 31% compared with intravenous administration.

In pre-dialysis patients with chronic renal failure following subcutaneous injection of 40 IU/kg body weight, the protracted absorption results in a concentration plateau, whereby the maximum concentration is reached after an average of approximately 14 hours. The terminal half-life is higher than after intravenous administration, with an average of 25 hours after single dosing and 34 hours in steady state after repeated dosing three times weekly, without leading to an accumulation of epoetin theta.

In cancer patients receiving chemotherapy, after repeated subcutaneous administration of 20,000 IU epoetin theta once-weekly, the terminal half-life is 29 hours after the first dose and 28 hours in steady state. No accumulation of epoetin theta was observed.

### Intravenous administration

In patients with chronic renal failure undergoing haemodialysis, the elimination half-life of epoetin theta is 6 hours after single dosing and 4 hours in steady state after repeated intravenous administration of 40 IU/kg body weight epoetin theta three times weekly. No accumulation of epoetin theta was observed. Following intravenous administration, the volume of distribution approximates to total blood volume.

## **5.3 Preclinical safety data**

Non-clinical data with epoetin theta reveal no special hazard for humans based on conventional studies of safety pharmacology and repeated dose toxicity.

Non-clinical data with other epoetins reveal no special hazard for humans based on conventional studies of genotoxicity and toxicity to reproduction.

In reproductive toxicity studies performed with other epoetins, effects interpreted as being secondary to decreased maternal body weight were observed at doses sufficiently in excess to the recommended human dose.

## **6. PHARMACEUTICAL PARTICULARS**

### **6.1 List of excipients**

Sodium dihydrogen phosphate dihydrate  
Sodium chloride  
Polysorbate 20  
Trometamol  
Hydrochloric acid (6 M) (for pH adjustment)  
Water for injections

### **6.2 Incompatibilities**

In the absence of compatibility studies, this medicinal product must not be mixed with other medicinal products.

### **6.3 Shelf life**

Biopoin 1,000 IU/0.5 ml solution for injection in pre-filled syringe  
2 years

Biopoin 2,000 IU/0.5 ml solution for injection in pre-filled syringe  
2 years

Biopoin 3,000 IU/0.5 ml solution for injection in pre-filled syringe  
2 years

Biopoin 4,000 IU/0.5 ml solution for injection in pre-filled syringe  
2 years

Biopoin 5,000 IU/0.5 ml solution for injection in pre-filled syringe  
30 months

Biopoin 10,000 IU/1 ml solution for injection in pre-filled syringe  
30 months

Biopoin 20,000 IU/1 ml solution for injection in pre-filled syringe  
30 months

Biopoin 30,000 IU/1 ml solution for injection in pre-filled syringe  
30 months

For the purpose of ambulatory use, the patient may remove the product from the refrigerator and store it at a temperature not above 25 °C for a single period of up to 7 days without exceeding the expiry date. Once removed from the refrigerator, the medicinal product must be used within this period or disposed of.

### **6.4 Special precautions for storage**

Store in a refrigerator (2 °C – 8 °C).

Do not freeze.

Keep the pre-filled syringe in the outer carton in order to protect from light.

## **6.5 Nature and contents of container**

### Biopoin 1,000 IU/0.5 ml solution for injection in pre-filled syringe

0.5 ml solution in a pre-filled syringe (type I glass) with a tip cap (bromobutyl rubber), a plunger stopper (teflonised chlorobutyl rubber) and an injection needle (stainless steel) or an injection needle (stainless steel) with a safety shield (safety needle) or an injection needle (stainless steel) with a safety device.

Pack sizes of 6 pre-filled syringes, 6 pre-filled syringes with safety needle or 6 pre-filled syringes with safety device.

Not all pack sizes may be marketed.

### Biopoin 2,000 IU/0.5 ml solution for injection in pre-filled syringe

0.5 ml solution in a pre-filled syringe (type I glass) with a tip cap (bromobutyl rubber), a plunger stopper (teflonised chlorobutyl rubber) and an injection needle (stainless steel) or an injection needle (stainless steel) with a safety shield (safety needle) or an injection needle (stainless steel) with a safety device.

Pack sizes of 6 pre-filled syringes; 6 pre-filled syringes with safety needle or 6 pre-filled syringes with safety device.

Not all pack sizes may be marketed.

### Biopoin 3,000 IU/0.5 ml solution for injection in pre-filled syringe

0.5 ml solution in a pre-filled syringe (type I glass) with a tip cap (bromobutyl rubber), a plunger stopper (teflonised chlorobutyl rubber) and an injection needle (stainless steel) or an injection needle (stainless steel) with a safety shield (safety needle) or an injection needle (stainless steel) with a safety device.

Pack sizes of 6 pre-filled syringes; 6 pre-filled syringes with safety needle or 6 pre-filled syringes with safety device.

Not all pack sizes may be marketed.

### Biopoin 4,000 IU/0.5 ml solution for injection in pre-filled syringe

0.5 ml solution in a pre-filled syringe (type I glass) with a tip cap (bromobutyl rubber), a plunger stopper (teflonised chlorobutyl rubber) and an injection needle (stainless steel) or an injection needle (stainless steel) with a safety shield (safety needle) or an injection needle (stainless steel) with a safety device.

Pack sizes of 6 pre-filled syringes; 6 pre-filled syringes with safety needle or 6 pre-filled syringes with safety device.

Not all pack sizes may be marketed.

### Biopoin 5,000 IU/0.5 ml solution for injection in pre-filled syringe

0.5 ml solution in a pre-filled syringe (type I glass) with a tip cap (bromobutyl rubber), a plunger stopper (teflonised chlorobutyl rubber) and an injection needle (stainless steel) or an injection needle (stainless steel) with a safety shield (safety needle) or an injection needle (stainless steel) with a safety device.

Pack sizes of 6 pre-filled syringes; 6 pre-filled syringes with safety needle or 6 pre-filled syringes with safety device.

Not all pack sizes may be marketed.

Biopoin 10,000 IU/1 ml solution for injection in pre-filled syringe

1 ml solution in a pre-filled syringe (type I glass) with a tip cap (bromobutyl rubber), a plunger stopper (teflonised chlorobutyl rubber) and an injection needle (stainless steel) or an injection needle (stainless steel) with a safety shield (safety needle) or an injection needle (stainless steel) with a safety device.

Pack sizes of 1, 4 and 6 pre-filled syringes; 1, 4 and 6 pre-filled syringes with safety needle or 1, 4 and 6 pre-filled syringes with safety device.

Not all pack sizes may be marketed.

Biopoin 20,000 IU/1 ml solution for injection in pre-filled syringe

1 ml solution in a pre-filled syringe (type I glass) with a tip cap (bromobutyl rubber), a plunger stopper (teflonised chlorobutyl rubber) and an injection needle (stainless steel) or an injection needle (stainless steel) with a safety shield (safety needle) or an injection needle (stainless steel) with a safety device.

Pack sizes of 1, 4 and 6 pre-filled syringes; 1, 4 and 6 pre-filled syringes with safety needle or 1, 4 and 6 pre-filled syringes with safety device.

Not all pack sizes may be marketed.

Biopoin 30,000 IU/1 ml solution for injection in pre-filled syringe

1 ml solution in a pre-filled syringe (type I glass) with a tip cap (bromobutyl rubber), a plunger stopper (teflonised chlorobutyl rubber) and an injection needle (stainless steel) or an injection needle (stainless steel) with a safety shield (safety needle) or an injection needle (stainless steel) with a safety device.

Pack sizes of 1, 4 and 6 pre-filled syringes; 1, 4 and 6 pre-filled syringes with safety needle or 1, 4 and 6 pre-filled syringes with safety device.

Not all pack sizes may be marketed.

## **6.6 Special precautions for disposal and other handling**

The pre-filled syringes are for single use only.

The solution should be visually inspected prior to use. Only clear, colourless solutions without particles should be used. The solution for injection should not be shaken. It should be allowed to reach a comfortable temperature (15 °C - 25 °C) for injection.

For instructions on how to inject the medicinal product, see package leaflet.

Any unused medicinal product or waste material should be disposed of in accordance with local requirements.

## **7. MARKETING AUTHORISATION HOLDER**

TEVA GmbH  
Graf-Arco-Straße 3  
89079 Ulm  
Germany

## **8. MARKETING AUTHORISATION NUMBER(S)**

Biopoin 1,000 IU/0.5 ml solution for injection in pre-filled syringe

EU/1/09/565/001

EU/1/09/565/002

EU/1/09/565/029

Biopoin 2,000 IU/0.5 ml solution for injection in pre-filled syringe

EU/1/09/565/003

EU/1/09/565/004

EU/1/09/565/030

Biopoin 3,000 IU/0.5 ml solution for injection in pre-filled syringe

EU/1/09/565/005

EU/1/09/565/006

EU/1/09/565/031

Biopoin 4,000 IU/0.5 ml solution for injection in pre-filled syringe

EU/1/09/565/007

EU/1/09/565/008

EU/1/09/565/032

Biopoin 5,000 IU/0.5 ml solution for injection in pre-filled syringe

EU/1/09/565/009

EU/1/09/565/010

EU/1/09/565/033

Biopoin 10,000 IU/1 ml solution for injection in pre-filled syringe

EU/1/09/565/011

EU/1/09/565/012

EU/1/09/565/013

EU/1/09/565/014

EU/1/09/565/015

EU/1/09/565/016

EU/1/09/565/034

EU/1/09/565/035

EU/1/09/565/036

Biopoin 20,000 IU/1 ml solution for injection in pre-filled syringe

EU/1/09/565/017

EU/1/09/565/018

EU/1/09/565/019

EU/1/09/565/020

EU/1/09/565/021

EU/1/09/565/022

EU/1/09/565/037

EU/1/09/565/038

EU/1/09/565/039

Biopoin 30,000 IU/1 ml solution for injection in pre-filled syringe

EU/1/09/565/023

EU/1/09/565/024

EU/1/09/565/025

EU/1/09/565/026

EU/1/09/565/027

EU/1/09/565/028

EU/1/09/565/040

EU/1/09/565/041

EU/1/09/565/042



## **9. DATE OF FIRST AUTHORISATION/RENEWAL OF THE AUTHORISATION**

Date of first authorisation: 23 October 2009.

Date of latest renewal: 26 August 2014.

## **10. DATE OF REVISION OF THE TEXT**

Detailed information on this medicinal product is available on the website of the European Medicines Agency <http://www.ema.europa.eu/>.

## **ANNEX II**

- A. MANUFACTURER OF THE BIOLOGICAL ACTIVE  
SUBSTANCE AND MANUFACTURER RESPONSIBLE FOR  
BATCH RELEASE**
- B. CONDITIONS OR RESTRICTIONS REGARDING SUPPLY AND USE**
- C. OTHER CONDITIONS AND REQUIREMENTS OF THE  
MARKETING AUTHORISATION**
- D. CONDITIONS OR RESTRICTIONS WITH REGARD TO  
THE SAFE AND EFFECTIVE USE OF THE MEDICINAL  
PRODUCT**

**A. MANUFACTURER OF THE BIOLOGICAL ACTIVE SUBSTANCE AND MANUFACTURER RESPONSIBLE FOR BATCH RELEASE**

Name and address of the manufacturer of the biological active substance

Teva Biotech GmbH  
Dornierstraße 10  
89079 Ulm  
Germany

Name and address of the manufacturer responsible for batch release

Merckle GmbH  
Graf-Arco-Straße 3  
89079 Ulm  
Germany

**B. CONDITIONS OR RESTRICTIONS REGARDING SUPPLY AND USE**

Medicinal product subject to restricted medical prescription (see Annex I: Summary of Product Characteristics, section 4.2).

**C. OTHER CONDITIONS AND REQUIREMENTS OF THE MARKETING AUTHORISATION**

● **Periodic safety update reports**

The requirements for submission of periodic safety update reports for this medicinal product are set out in the list of Union reference dates (EURD list) provided for under Article 107c(7) of Directive 2001/83/EC and any subsequent updates published on the European medicines web-portal.

**D. CONDITIONS OR RESTRICTIONS WITH REGARD TO THE SAFE AND EFFECTIVE USE OF THE MEDICINAL PRODUCT**

● **Risk Management Plan (RMP)**

The MAH shall perform the required pharmacovigilance activities and interventions detailed in the agreed RMP presented in Module 1.8.2 of the Marketing Authorisation and any agreed subsequent updates of the RMP.

An updated RMP should be submitted:

- At the request of the European Medicines Agency;
- Whenever the risk management system is modified, especially as the result of new information being received that may lead to a significant change to the benefit/risk profile or as the result of an important (pharmacovigilance or risk minimisation) milestone being reached.

**ANNEX III**  
**LABELLING AND PACKAGE LEAFLET**

## **A. LABELLING**

**PARTICULARS TO APPEAR ON THE OUTER PACKAGING**

**OUTER CARTON**

**1. NAME OF THE MEDICINAL PRODUCT**

Biopoin 1,000 IU/0.5 ml solution for injection in pre-filled syringe  
epoetin theta

**2. STATEMENT OF ACTIVE SUBSTANCE(S)**

One pre-filled syringe contains 1,000 international units (IU) (8.3 micrograms) epoetin theta in 0.5 ml solution for injection corresponding to 2,000 IU (16.7 micrograms) epoetin theta per ml.

**3. LIST OF EXCIPIENTS**

Excipients: Sodium dihydrogen phosphate dihydrate, sodium chloride, polysorbate 20, trometamol, hydrochloric acid (6 M) (for pH adjustment), water for injections.

**4. PHARMACEUTICAL FORM AND CONTENTS**

Solution for injection

6 pre-filled syringes containing 0.5 ml.  
6 pre-filled syringes with safety needle containing 0.5 ml.  
6 pre-filled syringes with safety device containing 0.5 ml.

**5. METHOD AND ROUTE(S) OF ADMINISTRATION**

Read the package leaflet before use.

For single use only.

Please use as follows:

Box for the prescribed posology

Subcutaneous or intravenous use

**6. SPECIAL WARNING THAT THE MEDICINAL PRODUCT MUST BE STORED OUT OF THE SIGHT AND REACH OF CHILDREN**

Keep out of the sight and reach of children.

**7. OTHER SPECIAL WARNING(S), IF NECESSARY**

**8. EXPIRY DATE**

EXP

Can be stored at room temperature (not above 25 °C) for up to 7 days within the shelf life.

End of 7 days period at room temperature: \_\_/\_\_/\_\_\_\_

**9. SPECIAL STORAGE CONDITIONS**

Store in a refrigerator.

Do not freeze.

Keep the pre-filled syringe in the outer carton in order to protect from light.

**10. SPECIAL PRECAUTIONS FOR DISPOSAL OF UNUSED MEDICINAL PRODUCTS OR WASTE MATERIALS DERIVED FROM SUCH MEDICINAL PRODUCTS, IF APPROPRIATE**

**11. NAME AND ADDRESS OF THE MARKETING AUTHORISATION HOLDER**

TEVA GmbH  
Graf-Arco-Straße 3  
89079 Ulm  
Germany

**12. MARKETING AUTHORISATION NUMBER(S)**

EU/1/09/565/001 6 pre-filled syringes  
EU/1/09/565/002 6 pre-filled syringes with safety device  
EU/1/09/565/029 6 pre-filled syringes with safety needle

**13. BATCH NUMBER**

Lot

**14. GENERAL CLASSIFICATION FOR SUPPLY**

Medicinal product subject to medical prescription.

**15. INSTRUCTIONS ON USE**

**16. INFORMATION IN BRAILLE**

Biopoin 1,000 IU/0.5 ml

**17. UNIQUE IDENTIFIER – 2D BARCODE**

2D barcode carrying the unique identifier included.

**18. UNIQUE IDENTIFIER - HUMAN READABLE DATA**

PC  
SN  
NN



**PARTICULARS TO APPEAR ON THE OUTER PACKAGING**

**OUTER CARTON**

**1. NAME OF THE MEDICINAL PRODUCT**

Biopoin 2,000 IU/0.5 ml solution for injection in pre-filled syringe

epoetin theta

**2. STATEMENT OF ACTIVE SUBSTANCE(S)**

One pre-filled syringe contains 2,000 international units (IU) (16.7 micrograms) epoetin theta in 0.5 ml solution for injection corresponding to 4,000 IU (33.3 micrograms) epoetin theta per ml.

**3. LIST OF EXCIPIENTS**

Excipients: Sodium dihydrogen phosphate dihydrate, sodium chloride, polysorbate 20, trometamol, hydrochloric acid (6 M) (for pH adjustment), water for injections.

**4. PHARMACEUTICAL FORM AND CONTENTS**

Solution for injection

6 pre-filled syringes containing 0.5 ml.

6 pre-filled syringes with safety needle containing 0.5 ml.

6 pre-filled syringes with safety device containing 0.5 ml.

**5. METHOD AND ROUTE(S) OF ADMINISTRATION**

Read the package leaflet before use.

For single use only.

Please use as follows:

Box for the prescribed posology

Subcutaneous or intravenous use

**6. SPECIAL WARNING THAT THE MEDICINAL PRODUCT MUST BE STORED OUT OF THE SIGHT AND REACH OF CHILDREN**

Keep out of the sight and reach of children.

**7. OTHER SPECIAL WARNING(S), IF NECESSARY**

**8. EXPIRY DATE**

EXP

Can be stored at room temperature (not above 25 °C) for up to 7 days within the shelf life.

End of 7 days period at room temperature: \_\_/\_\_/\_\_\_\_

**9. SPECIAL STORAGE CONDITIONS**

Store in a refrigerator.

Do not freeze.

Keep the pre-filled syringe in the outer carton in order to protect from light.

**10. SPECIAL PRECAUTIONS FOR DISPOSAL OF UNUSED MEDICINAL PRODUCTS OR WASTE MATERIALS DERIVED FROM SUCH MEDICINAL PRODUCTS, IF APPROPRIATE**

**11. NAME AND ADDRESS OF THE MARKETING AUTHORISATION HOLDER**

TEVA GmbH  
Graf-Arco-Straße 3  
89079 Ulm  
Germany

**12. MARKETING AUTHORISATION NUMBER(S)**

EU/1/09/565/003 6 pre-filled syringes  
EU/1/09/565/004 6 pre-filled syringes with safety device  
EU/1/09/565/030 6 pre-filled syringes with safety needle

**13. BATCH NUMBER**

Lot

**14. GENERAL CLASSIFICATION FOR SUPPLY**

Medicinal product subject to medical prescription.

**15. INSTRUCTIONS ON USE**

**16. INFORMATION IN BRAILLE**

Biopoin 2,000 IU/0.5 ml

**17. UNIQUE IDENTIFIER – 2D BARCODE**

2D barcode carrying the unique identifier included.

**18. UNIQUE IDENTIFIER - HUMAN READABLE DATA**

PC  
SN  
NN

**PARTICULARS TO APPEAR ON THE OUTER PACKAGING**

**OUTER CARTON**

**1. NAME OF THE MEDICINAL PRODUCT**

Biopoin 3,000 IU/0.5 ml solution for injection in pre-filled syringe

epoetin theta

**2. STATEMENT OF ACTIVE SUBSTANCE(S)**

One pre-filled syringe contains 3,000 international units (IU) (25 micrograms) epoetin theta in 0.5 ml solution for injection corresponding to 6,000 IU (50 micrograms) epoetin theta per ml.

**3. LIST OF EXCIPIENTS**

Excipients: Sodium dihydrogen phosphate dihydrate, sodium chloride, polysorbate 20, trometamol, hydrochloric acid (6 M) (for pH adjustment), water for injections.

**4. PHARMACEUTICAL FORM AND CONTENTS**

Solution for injection

6 pre-filled syringes containing 0.5 ml.

6 pre-filled syringes with safety needle containing 0.5 ml.

6 pre-filled syringes with safety device containing 0.5 ml.

**5. METHOD AND ROUTE(S) OF ADMINISTRATION**

Read the package leaflet before use.

For single use only.

Please use as follows:

Box for the prescribed posology

Subcutaneous or intravenous use

**6. SPECIAL WARNING THAT THE MEDICINAL PRODUCT MUST BE STORED OUT OF THE SIGHT AND REACH OF CHILDREN**

Keep out of the sight and reach of children.

**7. OTHER SPECIAL WARNING(S), IF NECESSARY**

**8. EXPIRY DATE**

EXP

Can be stored at room temperature (not above 25 °C) for up to 7 days within the shelf life.

End of 7 days period at room temperature: \_\_/\_\_/\_\_\_\_

**9. SPECIAL STORAGE CONDITIONS**

Store in a refrigerator.

Do not freeze.

Keep the pre-filled syringe in the outer carton in order to protect from light.

**10. SPECIAL PRECAUTIONS FOR DISPOSAL OF UNUSED MEDICINAL PRODUCTS OR WASTE MATERIALS DERIVED FROM SUCH MEDICINAL PRODUCTS, IF APPROPRIATE**

**11. NAME AND ADDRESS OF THE MARKETING AUTHORISATION HOLDER**

TEVA GmbH  
Graf-Arco-Straße 3  
89079 Ulm  
Germany

**12. MARKETING AUTHORISATION NUMBER(S)**

EU/1/09/565/005 6 pre-filled syringes  
EU/1/09/565/006 6 pre-filled syringes with safety device  
EU/1/09/565/031 6 pre-filled syringes with safety needle

**13. BATCH NUMBER**

Lot

**14. GENERAL CLASSIFICATION FOR SUPPLY**

Medicinal product subject to medical prescription.

**15. INSTRUCTIONS ON USE**

**16. INFORMATION IN BRAILLE**

Biopoin 3,000 IU/0.5 ml

**17. UNIQUE IDENTIFIER – 2D BARCODE**

2D barcode carrying the unique identifier included.

**18. UNIQUE IDENTIFIER - HUMAN READABLE DATA**

PC  
SN  
NN

**PARTICULARS TO APPEAR ON THE OUTER PACKAGING**

**OUTER CARTON**

**1. NAME OF THE MEDICINAL PRODUCT**

Biopoin 4,000 IU/0.5 ml solution for injection in pre-filled syringe

epoetin theta

**2. STATEMENT OF ACTIVE SUBSTANCE(S)**

One pre-filled syringe contains 4,000 international units (IU) (33.3 micrograms) epoetin theta in 0.5 ml solution for injection corresponding to 8,000 IU (66.7 micrograms) epoetin theta per ml.

**3. LIST OF EXCIPIENTS**

Excipients: Sodium dihydrogen phosphate dihydrate, sodium chloride, polysorbate 20, trometamol, hydrochloric acid (6 M) (for pH adjustment), water for injections.

**4. PHARMACEUTICAL FORM AND CONTENTS**

Solution for injection

6 pre-filled syringes containing 0.5 ml.

6 pre-filled syringes with safety needle containing 0.5 ml.

6 pre-filled syringes with safety device containing 0.5 ml.

**5. METHOD AND ROUTE(S) OF ADMINISTRATION**

Read the package leaflet before use.

For single use only.

Please use as follows:

Box for the prescribed dose

Subcutaneous or intravenous use

**6. SPECIAL WARNING THAT THE MEDICINAL PRODUCT MUST BE STORED OUT OF THE SIGHT AND REACH OF CHILDREN**

Keep out of the sight and reach of children.

**7. OTHER SPECIAL WARNING(S), IF NECESSARY**

**8. EXPIRY DATE**

EXP

Can be stored at room temperature (not above 25 °C) for up to 7 days within the shelf life.

End of 7 days period at room temperature: \_\_/\_\_/\_\_\_\_

**9. SPECIAL STORAGE CONDITIONS**

Store in a refrigerator.

Do not freeze.

Keep the pre-filled syringe in the outer carton in order to protect from light.

**10. SPECIAL PRECAUTIONS FOR DISPOSAL OF UNUSED MEDICINAL PRODUCTS OR WASTE MATERIALS DERIVED FROM SUCH MEDICINAL PRODUCTS, IF APPROPRIATE**

**11. NAME AND ADDRESS OF THE MARKETING AUTHORISATION HOLDER**

TEVA GmbH  
Graf-Arco-Straße 3  
89079 Ulm  
Germany

**12. MARKETING AUTHORISATION NUMBER(S)**

EU/1/09/565/007 6 pre-filled syringes  
EU/1/09/565/008 6 pre-filled syringes with safety device  
EU/1/09/565/032 6 pre-filled syringes with safety needle

**13. BATCH NUMBER**

Lot

**14. GENERAL CLASSIFICATION FOR SUPPLY**

Medicinal product subject to medical prescription.

**15. INSTRUCTIONS ON USE**

**16. INFORMATION IN BRAILLE**

Biopoin 4,000 IU/0.5 ml



**17. UNIQUE IDENTIFIER – 2D BARCODE**

2D barcode carrying the unique identifier included.

**18. UNIQUE IDENTIFIER - HUMAN READABLE DATA**

PC  
SN  
NN

**PARTICULARS TO APPEAR ON THE OUTER PACKAGING**

**OUTER CARTON**

**1. NAME OF THE MEDICINAL PRODUCT**

Biopoin 5,000 IU/0.5 ml solution for injection in pre-filled syringe

epoetin theta

**2. STATEMENT OF ACTIVE SUBSTANCE(S)**

One pre-filled syringe contains 5,000 international units (IU) (41.7 micrograms) epoetin theta in 0.5 ml solution for injection corresponding to 10,000 IU (83.3 micrograms) epoetin theta per ml.

**3. LIST OF EXCIPIENTS**

Excipients: Sodium dihydrogen phosphate dihydrate, sodium chloride, polysorbate 20, trometamol, hydrochloric acid (6 M) (for pH adjustment), water for injections.

**4. PHARMACEUTICAL FORM AND CONTENTS**

Solution for injection

6 pre-filled syringes containing 0.5 ml.

6 pre-filled syringes with safety needle containing 0.5 ml.

6 pre-filled syringes with safety device containing 0.5 ml.

**5. METHOD AND ROUTE(S) OF ADMINISTRATION**

Read the package leaflet before use.

For single use only.

Please use as follows:

Box for the prescribed posology

Subcutaneous or intravenous use

**6. SPECIAL WARNING THAT THE MEDICINAL PRODUCT MUST BE STORED OUT OF THE SIGHT AND REACH OF CHILDREN**

Keep out of the sight and reach of children.

**7. OTHER SPECIAL WARNING(S), IF NECESSARY**

**8. EXPIRY DATE**

EXP

Can be stored at room temperature (not above 25 °C) for up to 7 days within the shelf life.

End of 7 days period at room temperature: \_\_/\_\_/\_\_\_\_

**9. SPECIAL STORAGE CONDITIONS**

Store in a refrigerator.

Do not freeze.

Keep the pre-filled syringe in the outer carton in order to protect from light.

**10. SPECIAL PRECAUTIONS FOR DISPOSAL OF UNUSED MEDICINAL PRODUCTS OR WASTE MATERIALS DERIVED FROM SUCH MEDICINAL PRODUCTS, IF APPROPRIATE**

**11. NAME AND ADDRESS OF THE MARKETING AUTHORISATION HOLDER**

TEVA GmbH  
Graf-Arco-Straße 3  
89079 Ulm  
Germany

**12. MARKETING AUTHORISATION NUMBER(S)**

EU/1/09/565/009 6 pre-filled syringes  
EU/1/09/565/010 6 pre-filled syringes with safety device  
EU/1/09/565/033 6 pre-filled syringes with safety needle

**13. BATCH NUMBER**

Lot

**14. GENERAL CLASSIFICATION FOR SUPPLY**

Medicinal product subject to medical prescription.

**15. INSTRUCTIONS ON USE**

**16. INFORMATION IN BRAILLE**

Biopoin 5,000 IU/0.5 ml

**17. UNIQUE IDENTIFIER – 2D BARCODE**

2D barcode carrying the unique identifier included.

**18. UNIQUE IDENTIFIER - HUMAN READABLE DATA**

PC  
SN  
NN

## **PARTICULARS TO APPEAR ON THE OUTER PACKAGING**

### **OUTER CARTON**

#### **1. NAME OF THE MEDICINAL PRODUCT**

Biopoin 10,000 IU/1 ml solution for injection in pre-filled syringe

epoetin theta

#### **2. STATEMENT OF ACTIVE SUBSTANCE(S)**

One pre-filled syringe contains 10,000 international units (IU) (83.3 micrograms) epoetin theta in 1 ml solution for injection corresponding to 10,000 IU (83.3 micrograms) epoetin theta per ml.

#### **3. LIST OF EXCIPIENTS**

Excipients: Sodium dihydrogen phosphate dihydrate, sodium chloride, polysorbate 20, trometamol, hydrochloric acid (6 M) (for pH adjustment), water for injections.

#### **4. PHARMACEUTICAL FORM AND CONTENTS**

**Solution for injection**

- 1 pre-filled syringe containing 1 ml.
- 1 pre-filled syringe with safety needle containing 1 ml.
- 1 pre-filled syringe with safety device containing 1 ml.
- 4 pre-filled syringes containing 1 ml.
- 4 pre-filled syringes with safety needle containing 1 ml.
- 4 pre-filled syringes with safety device containing 1 ml.
- 6 pre-filled syringes containing 1 ml.
- 6 pre-filled syringes with safety needle containing 1 ml.
- 6 pre-filled syringes with safety device containing 1 ml.

#### **5. METHOD AND ROUTE(S) OF ADMINISTRATION**

Read the package leaflet before use.

For single use only.

Please use as follows:

Box for the prescribed posology

Subcutaneous or intravenous use

**6. SPECIAL WARNING THAT THE MEDICINAL PRODUCT MUST BE STORED OUT OF THE SIGHT AND REACH OF CHILDREN**

Keep out of the sight and reach of children.

**7. OTHER SPECIAL WARNING(S), IF NECESSARY**

**8. EXPIRY DATE**

EXP

Can be stored at room temperature (not above 25 °C) for up to 7 days within the shelf life.

End of 7 days period at room temperature: \_\_/\_\_/\_\_\_\_

**9. SPECIAL STORAGE CONDITIONS**

Store in a refrigerator.

Do not freeze.

Keep the pre-filled syringe in the outer carton in order to protect from light.

**10. SPECIAL PRECAUTIONS FOR DISPOSAL OF UNUSED MEDICINAL PRODUCTS OR WASTE MATERIALS DERIVED FROM SUCH MEDICINAL PRODUCTS, IF APPROPRIATE**

**11. NAME AND ADDRESS OF THE MARKETING AUTHORISATION HOLDER**

TEVA GmbH  
Graf-Arco-Straße 3  
89079 Ulm  
Germany

**12. MARKETING AUTHORISATION NUMBER(S)**

EU/1/09/565/011 1 pre-filled syringe  
EU/1/09/565/012 1 pre-filled syringe with safety device  
EU/1/09/565/013 4 pre-filled syringes  
EU/1/09/565/014 4 pre-filled syringes with safety device  
EU/1/09/565/015 6 pre-filled syringes  
EU/1/09/565/016 6 pre-filled syringes with safety device  
EU/1/09/565/034 1 pre-filled syringe with safety needle  
EU/1/09/565/035 4 pre-filled syringes with safety needle  
EU/1/09/565/036 6 pre-filled syringes with safety needle

**13. BATCH NUMBER**

Lot

**14. GENERAL CLASSIFICATION FOR SUPPLY**

Medicinal product subject to medical prescription.

**15. INSTRUCTIONS ON USE**

**16. INFORMATION IN BRAILLE**

Biopoin 10,000 IU/1 ml

**17. UNIQUE IDENTIFIER – 2D BARCODE**

2D barcode carrying the unique identifier included.

**18. UNIQUE IDENTIFIER - HUMAN READABLE DATA**

PC  
SN  
NN

## **PARTICULARS TO APPEAR ON THE OUTER PACKAGING**

### **OUTER CARTON**

#### **1. NAME OF THE MEDICINAL PRODUCT**

Biopoin 20,000 IU/1 ml solution for injection in pre-filled syringe

epoetin theta

#### **2. STATEMENT OF ACTIVE SUBSTANCE(S)**

One pre-filled syringe contains 20,000 international units (IU) (166.7 micrograms) epoetin theta in 1 ml solution for injection corresponding to 20,000 IU (166.7 micrograms) epoetin theta per ml.

#### **3. LIST OF EXCIPIENTS**

Excipients: Sodium dihydrogen phosphate dihydrate, sodium chloride, polysorbate 20, trometamol, hydrochloric acid (6 M) (for pH adjustment), water for injections.

#### **4. PHARMACEUTICAL FORM AND CONTENTS**

**Solution for injection**

- 1 pre-filled syringe containing 1 ml.
- 1 pre-filled syringe with safety needle containing 1 ml.
- 1 pre-filled syringe with safety device containing 1 ml.
- 4 pre-filled syringes containing 1 ml.
- 4 pre-filled syringes with safety needle containing 1 ml.
- 4 pre-filled syringes with safety device containing 1 ml.
- 6 pre-filled syringes containing 1 ml.
- 6 pre-filled syringes with safety needle containing 1 ml.
- 6 pre-filled syringes with safety device containing 1 ml.

#### **5. METHOD AND ROUTE(S) OF ADMINISTRATION**

Read the package leaflet before use.

For single use only.

Please use as follows:

Box for the prescribed posology

Subcutaneous or intravenous use



**6. SPECIAL WARNING THAT THE MEDICINAL PRODUCT MUST BE STORED OUT OF THE SIGHT AND REACH OF CHILDREN**

Keep out of the sight and reach of children.

**7. OTHER SPECIAL WARNING(S), IF NECESSARY**

**8. EXPIRY DATE**

EXP

Can be stored at room temperature (not above 25 °C) for up to 7 days within the shelf life.

End of 7 days period at room temperature: \_\_/\_\_/\_\_\_\_

**9. SPECIAL STORAGE CONDITIONS**

Store in a refrigerator.

Do not freeze.

Keep the pre-filled syringe in the outer carton in order to protect from light.

**10. SPECIAL PRECAUTIONS FOR DISPOSAL OF UNUSED MEDICINAL PRODUCTS OR WASTE MATERIALS DERIVED FROM SUCH MEDICINAL PRODUCTS, IF APPROPRIATE**

**11. NAME AND ADDRESS OF THE MARKETING AUTHORISATION HOLDER**

TEVA GmbH  
Graf-Arco-Straße 3  
89079 Ulm  
Germany

**12. MARKETING AUTHORISATION NUMBER(S)**

EU/1/09/565/017 1 pre-filled syringe  
EU/1/09/565/018 1 pre-filled syringe with safety device  
EU/1/09/565/019 4 pre-filled syringes  
EU/1/09/565/020 4 pre-filled syringes with safety device  
EU/1/09/565/021 6 pre-filled syringes  
EU/1/09/565/022 6 pre-filled syringes with safety device  
EU/1/09/565/037 1 pre-filled syringe with safety needle  
EU/1/09/565/038 4 pre-filled syringes with safety needle  
EU/1/09/565/039 6 pre-filled syringes with safety needle

**13. BATCH NUMBER**

Lot

**14. GENERAL CLASSIFICATION FOR SUPPLY**

Medicinal product subject to medical prescription.

**15. INSTRUCTIONS ON USE**

**16. INFORMATION IN BRAILLE**

Biopoin 20,000 IU/1 ml

**17. UNIQUE IDENTIFIER – 2D BARCODE**

2D barcode carrying the unique identifier included.

**18. UNIQUE IDENTIFIER - HUMAN READABLE DATA**

PC  
SN  
NN

## **PARTICULARS TO APPEAR ON THE OUTER PACKAGING**

### **OUTER CARTON**

#### **1. NAME OF THE MEDICINAL PRODUCT**

Biopoin 30,000 IU/1 ml solution for injection in pre-filled syringe

epoetin theta

#### **2. STATEMENT OF ACTIVE SUBSTANCE(S)**

One pre-filled syringe contains 30,000 international units (IU) (250 micrograms) epoetin theta in 1 ml solution for injection corresponding to 30,000 IU (250 micrograms) epoetin theta per ml.

#### **3. LIST OF EXCIPIENTS**

Excipients: Sodium dihydrogen phosphate dihydrate, sodium chloride, polysorbate 20, trometamol, hydrochloric acid (6 M) (for pH adjustment), water for injections.

#### **4. PHARMACEUTICAL FORM AND CONTENTS**

**Solution for injection**

- 1 pre-filled syringe containing 1 ml.
- 1 pre-filled syringe with safety needle containing 1 ml.
- 1 pre-filled syringe with safety device containing 1 ml.
- 4 pre-filled syringes containing 1 ml.
- 4 pre-filled syringes with safety needle containing 1 ml.
- 4 pre-filled syringes with safety device containing 1 ml.
- 6 pre-filled syringes containing 1 ml.
- 6 pre-filled syringes with safety needle containing 1 ml.
- 6 pre-filled syringes with safety device containing 1 ml.

#### **5. METHOD AND ROUTE(S) OF ADMINISTRATION**

Read the package leaflet before use.

For single use only.

Please use as follows:

Box for the prescribed posology

Subcutaneous or intravenous use

**6. SPECIAL WARNING THAT THE MEDICINAL PRODUCT MUST BE STORED OUT OF THE SIGHT AND REACH OF CHILDREN**

Keep out of the sight and reach of children.

**7. OTHER SPECIAL WARNING(S), IF NECESSARY**

**8. EXPIRY DATE**

EXP

Can be stored at room temperature (not above 25 °C) for up to 7 days within the shelf life.

End of 7 days period at room temperature: \_\_/\_\_/\_\_\_\_

**9. SPECIAL STORAGE CONDITIONS**

Store in a refrigerator.

Do not freeze.

Keep the pre-filled syringe in the outer carton in order to protect from light.

**10. SPECIAL PRECAUTIONS FOR DISPOSAL OF UNUSED MEDICINAL PRODUCTS OR WASTE MATERIALS DERIVED FROM SUCH MEDICINAL PRODUCTS, IF APPROPRIATE**

**11. NAME AND ADDRESS OF THE MARKETING AUTHORISATION HOLDER**

TEVA GmbH  
Graf-Arco-Straße 3  
89079 Ulm  
Germany

**12. MARKETING AUTHORISATION NUMBER(S)**

EU/1/09/565/023 1 pre-filled syringe  
EU/1/09/565/024 1 pre-filled syringe with safety device  
EU/1/09/565/025 4 pre-filled syringes  
EU/1/09/565/026 4 pre-filled syringes with safety device  
EU/1/09/565/027 6 pre-filled syringes  
EU/1/09/565/028 6 pre-filled syringes with safety device  
EU/1/09/565/040 1 pre-filled syringe with safety needle  
EU/1/09/565/041 4 pre-filled syringes with safety needle  
EU/1/09/565/042 6 pre-filled syringes with safety needle

**13. BATCH NUMBER**

Lot

**14. GENERAL CLASSIFICATION FOR SUPPLY**

Medicinal product subject to medical prescription.

**15. INSTRUCTIONS ON USE**

**16. INFORMATION IN BRAILLE**

Biopoin 30,000 IU/1 ml

**17. UNIQUE IDENTIFIER – 2D BARCODE**

2D barcode carrying the unique identifier included.

**18. UNIQUE IDENTIFIER - HUMAN READABLE DATA**

PC  
SN  
NN

**MINIMUM PARTICULARS TO APPEAR ON SMALL IMMEDIATE PACKAGING UNITS  
PRE-FILLED SYRINGE**

**1. NAME OF THE MEDICINAL PRODUCT AND ROUTE(S) OF ADMINISTRATION**

Biopoin 1,000 IU/0.5 ml injection

epoetin theta

SC IV

**2. METHOD OF ADMINISTRATION**

**3. EXPIRY DATE**

EXP

**4. BATCH NUMBER**

Lot

**5. CONTENTS BY WEIGHT, BY VOLUME OR BY UNIT**

0.5 ml

**6. OTHER**

IU

**MINIMUM PARTICULARS TO APPEAR ON SMALL IMMEDIATE PACKAGING UNITS  
PRE-FILLED SYRINGE**

**1. NAME OF THE MEDICINAL PRODUCT AND ROUTE(S) OF ADMINISTRATION**

Biopoin 2,000 IU/0.5 ml injection

epoetin theta

SC IV

**2. METHOD OF ADMINISTRATION**

**3. EXPIRY DATE**

EXP

**4. BATCH NUMBER**

Lot

**5. CONTENTS BY WEIGHT, BY VOLUME OR BY UNIT**

0.5 ml

**6. OTHER**

IU

**MINIMUM PARTICULARS TO APPEAR ON SMALL IMMEDIATE PACKAGING UNITS  
PRE-FILLED SYRINGE**

**1. NAME OF THE MEDICINAL PRODUCT AND ROUTE(S) OF ADMINISTRATION**

Biopoin 3,000 IU/0.5 ml injection

epoetin theta

SC IV

**2. METHOD OF ADMINISTRATION**

**3. EXPIRY DATE**

EXP

**4. BATCH NUMBER**

Lot

**5. CONTENTS BY WEIGHT, BY VOLUME OR BY UNIT**

0.5 ml

**6. OTHER**

IU



**MINIMUM PARTICULARS TO APPEAR ON SMALL IMMEDIATE PACKAGING UNITS  
PRE-FILLED SYRINGE**

**1. NAME OF THE MEDICINAL PRODUCT AND ROUTE(S) OF ADMINISTRATION**

Biopoin 4,000 IU/0.5 ml injection

epoetin theta

SC IV

**2. METHOD OF ADMINISTRATION**

**3. EXPIRY DATE**

EXP

**4. BATCH NUMBER**

Lot

**5. CONTENTS BY WEIGHT, BY VOLUME OR BY UNIT**

0.5 ml

**6. OTHER**

IU

**MINIMUM PARTICULARS TO APPEAR ON SMALL IMMEDIATE PACKAGING UNITS  
PRE-FILLED SYRINGE**

**1. NAME OF THE MEDICINAL PRODUCT AND ROUTE(S) OF ADMINISTRATION**

Biopoin 5,000 IU/0.5 ml injection

epoetin theta

SC IV

**2. METHOD OF ADMINISTRATION**

**3. EXPIRY DATE**

EXP

**4. BATCH NUMBER**

Lot

**5. CONTENTS BY WEIGHT, BY VOLUME OR BY UNIT**

0.5 ml

**6. OTHER**

IU

**MINIMUM PARTICULARS TO APPEAR ON SMALL IMMEDIATE PACKAGING UNITS  
PRE-FILLED SYRINGE**

**1. NAME OF THE MEDICINAL PRODUCT AND ROUTE(S) OF ADMINISTRATION**

Biopoin 10,000 IU/1 ml injection

epoetin theta

SC IV

**2. METHOD OF ADMINISTRATION**

**3. EXPIRY DATE**

EXP

**4. BATCH NUMBER**

Lot

**5. CONTENTS BY WEIGHT, BY VOLUME OR BY UNIT**

1 ml

**6. OTHER**

IU

**MINIMUM PARTICULARS TO APPEAR ON SMALL IMMEDIATE PACKAGING UNITS  
PRE-FILLED SYRINGE**

**1. NAME OF THE MEDICINAL PRODUCT AND ROUTE(S) OF ADMINISTRATION**

Biopoin 20,000 IU/1 ml injection

epoetin theta

SC IV

**2. METHOD OF ADMINISTRATION**

**3. EXPIRY DATE**

EXP

**4. BATCH NUMBER**

Lot

**5. CONTENTS BY WEIGHT, BY VOLUME OR BY UNIT**

1 ml

**6. OTHER**

IU

**MINIMUM PARTICULARS TO APPEAR ON SMALL IMMEDIATE PACKAGING UNITS  
PRE-FILLED SYRINGE**

**1. NAME OF THE MEDICINAL PRODUCT AND ROUTE(S) OF ADMINISTRATION**

Biopoin 30,000 IU/1 ml injection

epoetin theta

SC IV

**2. METHOD OF ADMINISTRATION**

**3. EXPIRY DATE**

EXP

**4. BATCH NUMBER**

Lot

**5. CONTENTS BY WEIGHT, BY VOLUME OR BY UNIT**

1 ml

**6. OTHER**

IU

**B. PACKAGE LEAFLET**

## Package leaflet: Information for the user

**Biopoin 1,000 IU/0.5 ml solution for injection in pre-filled syringe**  
**Biopoin 2,000 IU/0.5 ml solution for injection in pre-filled syringe**  
**Biopoin 3,000 IU/0.5 ml solution for injection in pre-filled syringe**  
**Biopoin 4,000 IU/0.5 ml solution for injection in pre-filled syringe**  
**Biopoin 5,000 IU/0.5 ml solution for injection in pre-filled syringe**  
**Biopoin 10,000 IU/1 ml solution for injection in pre-filled syringe**  
**Biopoin 20,000 IU/1 ml solution for injection in pre-filled syringe**  
**Biopoin 30,000 IU/1 ml solution for injection in pre-filled syringe**

epoetin theta

### **Read all of this leaflet carefully before you start using this medicine because it contains important information for you.**

- Keep this leaflet. You may need to read it again.
- If you have any further questions, ask your doctor, pharmacist or nurse.
- This medicine has been prescribed for you only. Do not pass it on to others. It may harm them, even if their signs of illness are the same as yours.
- If you get any side effects, talk to your doctor, pharmacist or nurse. This includes any possible side effects not listed in this leaflet. See section 4.

### **What is in this leaflet**

1. What Biopoin is and what it is used for
2. What you need to know before you use Biopoin
3. How to use Biopoin
4. Possible side effects
5. How to store Biopoin
6. Contents of the pack and other information
7. Information for injecting yourself

## **1. What Biopoin is and what it is used for**

### **What Biopoin is**

Biopoin contains the active substance epoetin theta, which is almost identical to erythropoietin, a natural hormone produced by your body. Epoetin theta is a protein produced by biotechnology. It works in exactly the same way as erythropoietin. Erythropoietin is produced in your kidneys and stimulates your bone marrow to produce red blood cells. Red blood cells are very important for distributing oxygen within your body.

### **What Biopoin is used for**

Biopoin is used for the treatment of anaemia accompanied by symptoms (for example fatigue, weakness and shortness of breath). Anaemia occurs when your blood does not contain enough red blood cells. Treatment for anaemia is given to adult patients with chronic renal failure or to adult patients with non-myeloid cancer (cancer not originating in the bone marrow) who at the same time are receiving chemotherapy (medicines to treat cancer).

## **2. What you need to know before you use Biopoin**

### **Do NOT use Biopoin**

- if you are allergic to epoetin theta, another epoetin or any of the other ingredients of this medicine (listed in section 6);
- if you have high blood pressure that cannot be controlled.

## Warnings and precautions

### General

This medicine may not be suitable for the following patients. Please speak with your doctor if you belong to one of these patient groups:

- patients with liver problems,
- patients with pathological changes in their red blood cells (homozygous sickle cell anaemia).

Your blood pressure needs to be checked closely before and during treatment with this medicine. If your blood pressure rises, your doctor may give you medicines to reduce your blood pressure. If you are already taking a medicine to reduce your blood pressure, your doctor might increase the dose. It may also be necessary to reduce your dose of Biopoin or to stop the treatment with Biopoin for a short period of time.

If you get headaches, especially sudden, stabbing, migraine-like headaches, confusion, speech disturbance, unsteady walking, fits or convulsions, tell your doctor immediately. These may be signs of severely elevated blood pressure, even if your blood pressure is usually normal or low. It needs to be treated at once.

Your doctor will carry out regular blood tests in order to monitor various blood components and their levels. In addition, the iron level in your blood will be checked before and during treatment with this medicine. If your iron level is too low, your doctor may also prescribe you an iron preparation.

If you feel tired and weak or experience breathlessness, you must consult your doctor. These symptoms could indicate that your treatment with this medicine is ineffective. Your doctor will check that you do not have other causes of anaemia and may perform blood tests or examine your bone marrow.

Your healthcare professional will always record the exact product you are using. This can help to provide more information on the safety of medicines like this one.

Healthy people should not use Biopoin. The use of this medicine by healthy people can excessively increase certain blood parameters and in so doing cause problems with the heart or blood vessels that can be life threatening.

Serious skin reactions including Stevens-Johnson syndrome (SJS) and toxic epidermal necrolysis (TEN) have been reported in association with epoetin treatment. SJS/TEN can appear initially as reddish target-like spots or circular patches often with central blisters on the trunk. Also, ulcers of mouth, throat, nose, genitals and eyes (red and swollen eyes) can occur. These serious skin rashes are often preceded by fever and/or flu-like symptoms. The rashes may progress to widespread peeling of the skin and life-threatening complications. If you develop a serious rash or another of these skin symptoms, stop using Biopoin and contact your doctor or seek medical attention immediately.

### Anaemia caused by chronic renal failure

If you are a patient with chronic renal failure, your doctor will check that a particular blood parameter (haemoglobin) does not exceed a defined threshold. If this blood parameter becomes too high, heart or vascular problems might occur, increasing the risk of death.

If you are a patient with chronic renal failure, and particularly if you do not respond properly to Biopoin, your doctor will check your dose of Biopoin because repeatedly increasing your dose of Biopoin if you are not responding to treatment may increase the risk of having a problem of the heart or the blood vessels and could increase risk of myocardial infarction, stroke and death.

If you have hardening of the blood vessels in your kidneys (nephrosclerosis) but do not need to undergo dialysis, your doctor will consider whether treatment is suitable for you. This is because one cannot rule out a possible acceleration of progression of kidney disease with absolute certainty.



If you are on dialysis, medicines that prevent blood coagulation are used. If you are being treated with Biopoin, the dose of the anticoagulant medicine may have to be increased. Otherwise the increased number of red blood cells may cause blocking of the arterio-venous fistula (an artificial connection between an artery and a vein which is surgically prepared in dialysis patients).

#### Anaemia in cancer patients

If you are a cancer patient you should be aware that this medicine may act as a blood cell growth factor and in some circumstances may have a negative impact on your cancer. Depending on your individual situation a blood transfusion may be preferable. Please discuss this with your doctor.

#### **Children and adolescents**

Do not give this medicine to children and adolescents under 18 years of age because there are no data that show that this medicine is safe and works in this age group.

#### **Other medicines and Biopoin**

Please tell your doctor or pharmacist if you are taking, have recently taken or might take any other medicines.

#### **Pregnancy and breast-feeding**

Biopoin has not been tested in pregnant women. It is important to tell your doctor if you are pregnant, think you may be pregnant or plan to get pregnant, as the doctor may decide that you should not use this medicine.

It is unknown whether the active substance in this medicine passes over to the breast milk. Therefore, your doctor may decide that you should not use this medicine if you are breast-feeding.

#### **Driving and using machines**

This medicine does not affect your ability to drive and use machines.

#### **Biopoin contains sodium**

This medicine contains less than 1 mmol sodium (23 mg) per pre-filled syringe, i.e. essentially 'sodium-free'.

### **3. How to use Biopoin**

Your treatment with this medicine is being initiated by a doctor who is experienced in the above-mentioned indications.

Always use this medicine exactly as your doctor or pharmacist has told you. Check with your doctor or pharmacist if you are not sure.

#### **The recommended dose is...**

The dose of Biopoin (expressed in International Units or IU) depends on your disease condition, your body weight and the way the injection is given (under the skin [subcutaneous injection] or into a vein [intravenous injection]). Your doctor will work out the right dose for you.

#### Anaemia caused by chronic renal failure

The injections are given under the skin or into a vein. Patients on haemodialysis will usually receive the injection at the end of dialysis via an arterio-venous fistula. Patients who do not have to undergo dialysis are usually given the injections under the skin. Your doctor will carry out blood tests regularly and adjust the dosage or suspend the treatment if necessary. The haemoglobin values in your blood should not exceed a value of 12 g/dl (7.45 mmol/l). Your doctor will use the lowest effective dose to control the symptoms of your anaemia. If you do not respond adequately to Biopoin, your doctor will check your dose and will inform you if you need to change doses of Biopoin.

Treatment with Biopoin is divided into two stages:

a) Correcting the anaemia

The initial dose for injections under the skin is 20 IU per kg of bodyweight, given 3 times per week. If necessary, your doctor will increase your dose at monthly intervals.

The initial dose for injections into veins is 40 IU per kg of bodyweight, given 3 times per week. If necessary, your doctor will increase your dose at monthly intervals.

b) Maintaining sufficient red blood cell levels

Once an adequate number of red blood cells has been reached, the maintenance dose required to keep the number constant will be determined by your doctor.

In the case of injections under the skin, the weekly dose can be given either as 1 injection per week or as 3 divided injections per week.

In the case of injections into veins, your dosage may be switched to 2 injections weekly.

If the frequency of administration is changed, dose adjustments may be necessary.

Treatment with Biopoin is normally a long-term therapy.

The maximum dose should not exceed 700 IU per kg of bodyweight per week.

Anaemia in cancer patients

Injections are given under the skin. The injection will be given once-weekly. The initial dose is 20,000 IU. Your doctor will carry out blood tests regularly and adjust the dosage or suspend the treatment if necessary. The haemoglobin values in your blood should not exceed a value of 12 g/dl (7.45 mmol/l). You will usually receive Biopoin until 1 month after the end of chemotherapy.

The maximum dose should not exceed 60,000 IU.

**How are the injections given?**

This medicine is given as an injection using a pre-filled syringe. The injection is given either into a vein (intravenous injection) or into the tissue just under the skin (subcutaneous injection).

If you are receiving Biopoin as an injection under the skin, your doctor may suggest that you learn how to inject yourself this medicine. Your doctor or nurse will give you instructions on how to do this. Do not attempt to give this medicine to yourself without this training. Some of the information required for using the pre-filled syringe can be found at the end of this package leaflet (see section “7. Information for injecting yourself”). Proper treatment of your disease, however, requires close and constant co-operation with your doctor.

Each pre-filled syringe is for single use only.

**If you use more Biopoin than you should**

Do not increase the dose your doctor has given you. If you think you have injected more Biopoin than you should, contact your doctor. It is unlikely to be serious. Even at very high blood levels, no symptoms of poisoning have been observed.

**If you forget to use Biopoin**

If you have missed an injection, or injected too little, talk to your doctor. Do not inject a double dose to make up for a forgotten dose.

**If you stop using Biopoin**

Before you stop using this medicine, talk to your doctor.

If you have any further questions on the use of this medicine, ask your doctor, pharmacist or nurse.

#### 4. Possible side effects

Like all medicines, this medicine can cause side effects, although not everybody gets them.

##### **Serious side effects:**

- Severely elevated blood pressure:  
If you get headaches, especially sudden, stabbing, migraine-like headaches, confusion, speech disturbance, unsteady walking, fits or convulsions, tell your doctor immediately. These may be signs of severely elevated blood pressure (common in patients with chronic renal failure, may affect up to 1 in 10 people), even if your blood pressure is usually normal or low. It needs to be treated at once.
- Allergic reactions:  
Allergic reactions such as skin rash, raised areas of the skin that itch and severe allergic reactions with weakness, drop in blood pressure, difficulty breathing and swelling of the face have been reported (not known, frequency cannot be estimated from the available data). If you think you are having this type of reaction, you must stop your Biopoin injection and get medical help immediately.
- Serious skin rashes:  
Serious skin rashes including Stevens-Johnson syndrome and toxic epidermal necrolysis have been reported in association with epoetin treatment. These can appear as reddish target-like macules or circular patches often with central blisters on the trunk, skin peeling, ulcers of mouth, throat, nose, genitals and eyes and can be preceded by fever and flu-like symptoms. Stop using Biopoin if you develop these symptoms and contact your doctor or seek medical attention immediately. See also section 2.

##### **You may experience the following additional side effects:**

###### Common (may affect up to 1 in 10 people)

- Headache;
- High blood pressure;
- Flu-like symptoms, such as fever, chills, feeling of weakness, tiredness;
- Skin reactions, such as rash, itching or reactions around the injection site.

###### Common in patients with chronic renal failure (may affect up to 1 in 10 people)

- Blood clot in the arterio-venous fistula in patients on dialysis.

###### Common in cancer patients (may affect up to 1 in 10 people)

- Joint pain.

###### Not known in patients with chronic renal failure (frequency cannot be estimated from the available data)

- Cases of a condition called pure red cell aplasia (PRCA) have been reported. PRCA means that the body has stopped or reduced the production of red blood cells which causes severe anaemia. If your doctor suspects or confirms that you have this condition, you must not be treated with Biopoin or another epoetin.

###### Not known in cancer patients (frequency cannot be estimated from the available data)

- Thromboembolic events, e.g. increase in blood clots.

##### **Reporting of side effects**

If you get any side effects, talk to your doctor, pharmacist or nurse. This includes any possible side effects not listed in this leaflet. You can also report side effects directly via the national reporting system listed in [Appendix V](#). By reporting side effects you can help provide more information on the safety of this medicine.

## 5. How to store Biopoin

Keep this medicine out of the sight and reach of children.

Do not use this medicine after the expiry date which is stated on the outer carton and on the pre-filled syringe after EXP. The expiry date refers to the last day of that month.

Store in a refrigerator (2 °C – 8 °C).

Do not freeze.

Keep the pre-filled syringe in the outer carton, in order to protect from light.

You may remove Biopoin from the refrigerator and store it not above 25 °C for a single period of up to 7 days without exceeding the expiry date. Once you have removed your medicine from the refrigerator you must use it within this period or it must be discarded.

Do not use this medicine if you notice it is cloudy or there are particles in it.

Do not throw away any medicines via wastewater or household waste. Ask your pharmacist how to throw away medicines you no longer use. These measures will help protect the environment.

## 6. Contents of the pack and other information

### What Biopoin contains

- The active substance is epoetin theta.  
Biopoin 1,000 IU/0.5 ml: One pre-filled syringe contains 1,000 international units (IU) (8.3 micrograms) epoetin theta in 0.5 ml solution for injection corresponding to 2,000 international units (IU) (16.7 micrograms) per ml.  
Biopoin 2,000 IU/0.5 ml: One pre-filled syringe contains 2,000 international units (IU) (16.7 micrograms) epoetin theta in 0.5 ml solution for injection corresponding to 4,000 international units (IU) (33.3 micrograms) per ml.  
Biopoin 3,000 IU/0.5 ml: One pre-filled syringe contains 3,000 international units (IU) (25 micrograms) epoetin theta in 0.5 ml solution for injection corresponding to 6,000 international units (IU) (50 micrograms) per ml.  
Biopoin 4,000 IU/0.5 ml: One pre-filled syringe contains 4,000 international units (IU) (33.3 micrograms) epoetin theta in 0.5 ml solution for injection corresponding to 8,000 international units (IU) (66.7 micrograms) per ml.  
Biopoin 5,000 IU/0.5 ml: One pre-filled syringe contains 5,000 international units (IU) (41.7 micrograms) epoetin theta in 0.5 ml solution for injection corresponding to 10,000 international units (IU) (83.3 micrograms) per ml.  
Biopoin 10,000 IU/1 ml: One pre-filled syringe contains 10,000 international units (IU) (83.3 micrograms) epoetin theta in 1 ml solution for injection corresponding to 10,000 international units (IU) (83.3 micrograms) per ml.  
Biopoin 20,000 IU/1 ml: One pre-filled syringe contains 20,000 international units (IU) (166.7 micrograms) epoetin theta in 1 ml solution for injection corresponding to 20,000 international units (IU) (166.7 micrograms) per ml.  
Biopoin 30,000 IU/1 ml: One pre-filled syringe contains 30,000 international units (IU) (250 micrograms) epoetin theta in 1 ml solution for injection corresponding to 30,000 international units (IU) (250 micrograms) per ml.
- The other ingredients are sodium dihydrogen phosphate dihydrate, sodium chloride, polysorbate 20, trometamol, hydrochloric acid (6 M) (for pH adjustment) and water for injections.

### What Biopoin looks like and contents of the pack

Biopoin is a clear and colourless solution for injection in pre-filled syringe along with an injection needle.

Biopoin 1,000 IU/0.5 ml, Biopoin 2,000 IU/0.5 ml, Biopoin 3,000 IU/0.5 ml, Biopoin 4,000 IU/0.5 ml and Biopoin 5,000 IU/0.5 ml: Each pre-filled syringe contains 0.5 ml of solution. Packs of 6 pre-filled syringes; 6 pre-filled syringes with safety needle or 6 pre-filled syringes with safety device.

Biopoin 10,000 IU/1 ml, Biopoin 20,000 IU/1 ml and Biopoin 30,000 IU/1 ml: Each pre-filled syringe contains 1 ml of solution. Packs of 1, 4 and 6 pre-filled syringes; 1, 4 and 6 pre-filled syringes with safety needle or 1, 4 and 6 pre-filled syringes with safety device.

Not all pack sizes may be marketed.

#### **Marketing Authorisation Holder**

TEVA GmbH  
Graf-Arco-Straße 3  
89079 Ulm  
Germany

#### **Manufacturer**

Merckle GmbH  
Graf-Arco-Straße 3  
89079 Ulm  
Germany

For any information about this medicine, please contact the local representative of the Marketing Authorisation Holder:

#### **België/Belgique/Belgien**

Teva Pharma Belgium N.V./S.A./AG  
Tél/Tel: +32 38207373

#### **Lietuva**

UAB Teva Baltics  
Tel: +370 52660203

#### **България**

Тева Фарма ЕАД  
Тел: +359 24899585

#### **Luxembourg/Luxemburg**

Teva Pharma Belgium N.V./S.A./AG  
Belgique/Belgien  
Tél/Tel: +32 38207373

#### **Česká republika**

Teva Pharmaceuticals CR, s.r.o.  
Tel: +420 251007111

#### **Magyarország**

Teva Gyógyszergyár Zrt.  
Tel: +36 12886400

#### **Danmark**

Teva Denmark A/S  
Tlf: +45 44985511

#### **Malta**

Teva Pharmaceuticals Ireland  
L-Irlanda  
Tel: +44 2075407117

#### **Deutschland**

TEVA GmbH  
Tel: +49 73140208

#### **Nederland**

Teva Nederland B.V.  
Tel: +31 8000228400

#### **Eesti**

UAB Teva Baltics Eesti filiaal  
Tel: +372 6610801

#### **Norge**

Teva Norway AS  
Tlf: +47 66775590

#### **Ελλάδα**

TEVA HELLAS A.E.  
Τηλ: +30 2118805000

#### **Österreich**

ratiopharm Arzneimittel Vertriebs-GmbH  
Tel: +43 1970070

**España**

Teva Pharma, S.L.U.  
Tel: +34 913873280

**France**

Teva Santé  
Tél: +33 155917800

**Hrvatska**

Pliva Hrvatska d.o.o.  
Tel: +385 13720000

**Ireland**

Teva Pharmaceuticals Ireland  
Tel: +44 2075407117

**Ísland**

Teva Pharma Iceland ehf.  
Sími: +354 5503300

**Italia**

Teva Italia S.r.l.  
Tel: +39 028917981

**Κύπρος**

TEVA HELLAS A.E.  
Ελλάδα  
Τηλ: +30 2118805000

**Latvija**

UAB Teva Baltics filiāle Latvijā  
Tel: +371 67323666

**Polska**

Teva Pharmaceuticals Polska Sp. z o.o.  
Tel: +48 223459300

**Portugal**

Teva Pharma - Produtos Farmacêuticos, Lda.  
Tel: +351 214767550

**România**

Teva Pharmaceuticals S.R.L.  
Tel: +40 212306524

**Slovenija**

Pliva Ljubljana d.o.o.  
Tel: +386 15890390

**Slovenská republika**

TEVA Pharmaceuticals Slovakia s.r.o.  
Tel: +421 257267911

**Suomi/Finland**

Teva Finland Oy  
Puh/Tel: +358 201805900

**Sverige**

Teva Sweden AB  
Tel: +46 42121100

**United Kingdom (Northern Ireland)**

Teva Pharmaceuticals Ireland  
Ireland  
Tel: +44 2075407117

**This leaflet was last approved in .**

Detailed information on this medicine is available on the European Medicines Agency web site:  
<http://www.ema.europa.eu>.

## **7. Information for injecting yourself**

This section contains information on how to give yourself an injection of Biopoin under the skin. It is important that you do not try to give yourself the injection unless you have received special training from your doctor or nurse. If you are not sure about giving yourself the injection or you have any questions, please ask your doctor or nurse for help.

### **How Biopoin is used**

You will need to give yourself the injection into the tissue just under the skin. This is known as a subcutaneous injection.

### **Equipment that you need**

To give yourself an injection into the tissue under the skin you will need:

- a pre-filled syringe of Biopoin,
- an alcohol wipe,

- a piece of gauze bandage or a sterile gauze swab,
- a puncture-proof container (plastic container provided by the hospital or pharmacy) so you can dispose of used syringes safely.

### What you should do before your injection

1. Take one blister with a pre-filled syringe out of the refrigerator.
2. Open the blister and take the pre-filled syringe and the needle container out of the blister. Do not pick up the pre-filled syringe by the plunger or tip cap.
3. Check the expiry date on the pre-filled syringe label (EXP). Do not use it if the date has passed the last day of the month shown.
4. Check the appearance of Biopoin. It must be a clear and colourless liquid. If there are particles in it or if it is cloudy, you must not use it.
5. There is a cap at the end of the needle container. Break the labelled seal and remove the cap (see picture 1).
6. Remove the tip cap from the pre-filled syringe (see picture 2).
7. Attach the needle to the syringe (see picture 3). Do not remove the needle cover at this time.
8. For a more comfortable injection, let the pre-filled syringe stand for 30 minutes to reach room temperature (not above 25 °C) or hold the pre-filled syringe gently in your hand for a few minutes. Do **not** warm Biopoin in any other way (for example, do not warm it in a microwave or in hot water).
9. Do **not** remove the needle cover from the syringe until you are ready to inject.
10. Find a comfortable, well-lit place. Put everything you need within easy reach (the Biopoin pre-filled syringe, an alcohol wipe, a piece of gauze bandage or a sterile gauze swab and the puncture-proof container).
11. **Wash your hands thoroughly.**

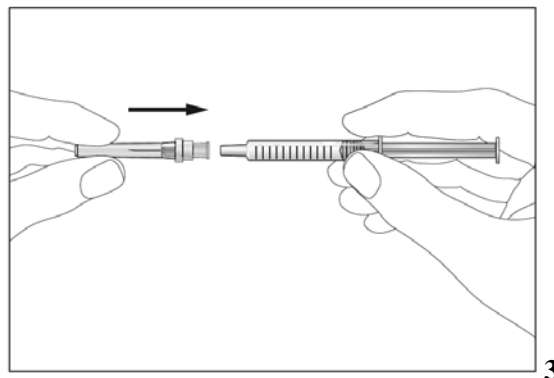
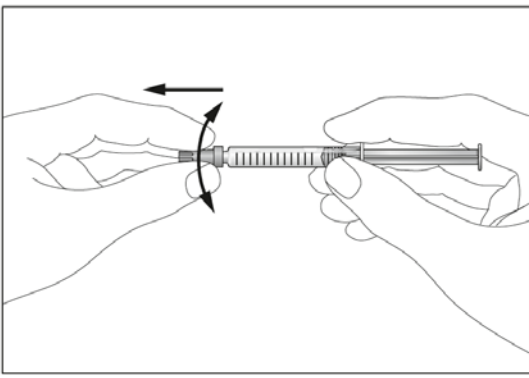
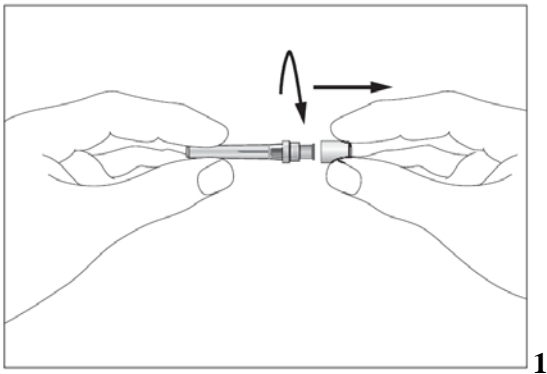

### How to prepare for your injection

Before you give yourself an Biopoin injection, you must do the following:

1. Hold the syringe and gently remove the cover from the needle without twisting. Pull straight as shown in picture 4. Do not touch the needle or push the plunger.
2. You may notice small air bubbles in the pre-filled syringe. If there are air bubbles present, gently tap the syringe with your fingers until the air bubbles rise to the top of the syringe. With

the syringe pointing upwards, expel all air from the syringe by pushing the plunger slowly upwards.

3. The syringe has a scale on the syringe barrel. Push the plunger up to the number (IU) on the syringe that matches the dose of Biopoin that your doctor prescribed.
4. Check again to make sure the correct dose of Biopoin is in the syringe.
5. You can now use the pre-filled syringe.

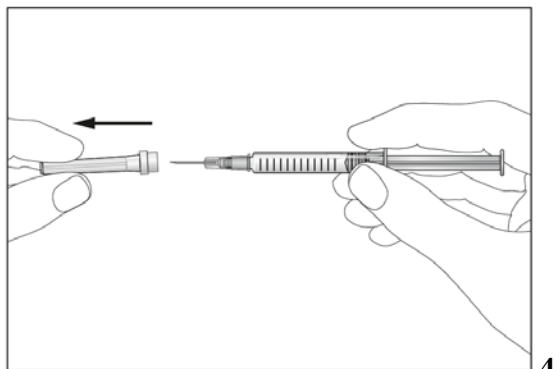

4

### Where your injection should be given

The most suitable places to inject yourself are:

- the top of your thighs,
- the abdomen, except for the area around the navel (see grey areas in picture 5).

If someone else is injecting you, they can also use the back and side of your upper arms (see grey areas in picture 6).

It is better to change the injection site every day to avoid the risk of soreness at any one site.

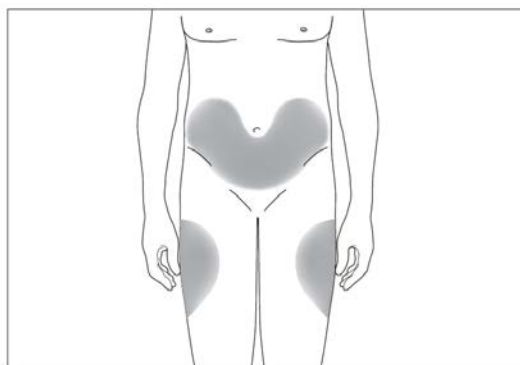

5

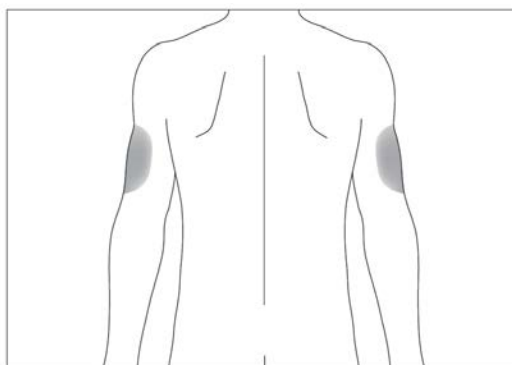

6

### How you should inject yourself

1. Disinfect the injection site on the skin by using an alcohol wipe and pinch the skin between your thumb and forefinger, without squeezing it (see picture 7).
2. Put the needle fully into the skin as shown by your doctor or nurse. The angle between the syringe and skin should not be too narrow (at least  $45^\circ$ , see picture 8).
3. Inject the liquid into the tissue slowly and evenly, always keeping your skin pinched.
4. After injecting the liquid, remove the needle and let go of your skin.
5. Press the injection site with a piece of gauze bandage or a sterile gauze swab for several seconds.
6. Only use each syringe for one injection. Do not use any Biopoin that is left in the syringe.



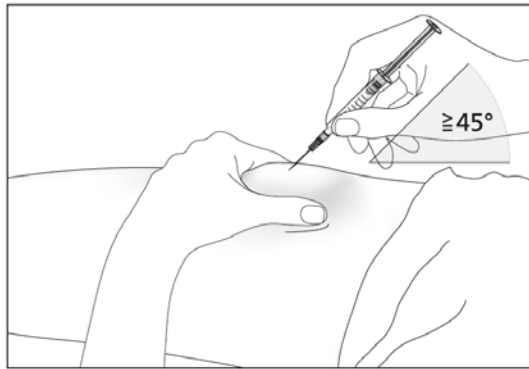
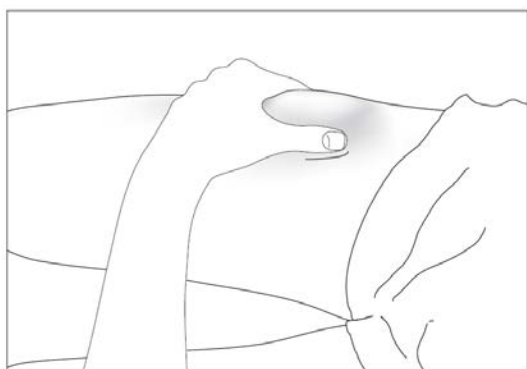

## Remember

If you have any problems, please ask your doctor or nurse for help and advice.

## Disposing of used syringes

- Do not put the cover back on used needles.
- Put used syringes into the puncture-proof container and keep this container out of the sight and reach of children.
- Dispose of the full puncture-proof container as instructed by your doctor, pharmacist or nurse.
- Never put the syringes that you have used into your normal household rubbish bin.

## 7. Information for injecting yourself

This section contains information on how to give yourself an injection of Biopoin under the skin. It is important that you do not try to give yourself the injection unless you have received special training from your doctor or nurse. If you are not sure about giving yourself the injection or you have any questions, please ask your doctor or nurse for help.

### How Biopoin is used

You will need to give yourself the injection into the tissue just under the skin. This is known as a subcutaneous injection.

### Equipment that you need

To give yourself an injection into the tissue under the skin you will need:

- a pre-filled syringe of Biopoin,
- an alcohol wipe,
- a piece of gauze bandage or a sterile gauze swab,
- a puncture-proof container (plastic container provided by the hospital or pharmacy) so you can dispose of used syringes safely.

### What you should do before your injection

1. Take one blister with a pre-filled syringe out of the refrigerator.
2. Open the blister and take the pre-filled syringe and the needle bag out of the blister. Do not pick up the pre-filled syringe by the plunger or tip cap.
3. Check the expiry date on the pre-filled syringe label (EXP). Do not use it if the date has passed the last day of the month shown.
4. Check the appearance of Biopoin. It must be a clear and colourless liquid. If there are particles in it or if it is cloudy, you must not use it.
5. There are flaps at the end of the needle bag. Open the needle bag at the flaps (see picture 1).
6. Remove the tip cap from the pre-filled syringe (see picture 2).
7. Attach the needle to the syringe (see picture 3). Do not remove the needle cover at this time.
8. Move the safety shield away from the needle and toward the syringe barrel. The safety shield will remain in the position you set (see picture 4)
9. For a more comfortable injection, let the pre-filled syringe stand for 30 minutes to reach room temperature (not above 25 °C) or hold the pre-filled syringe gently in your hand for a few

minutes. Do **not** warm Biopoin in any other way (for example, do not warm it in a microwave or in hot water).

10. Do **not** remove the needle cover from the syringe until you are ready to inject.
11. Find a comfortable, well-lit place. Put everything you need within easy reach (the Biopoin pre-filled syringe, an alcohol wipe, a piece of gauze bandage or a sterile gauze swab and the puncture-proof container).
12. **Wash your hands thoroughly.**

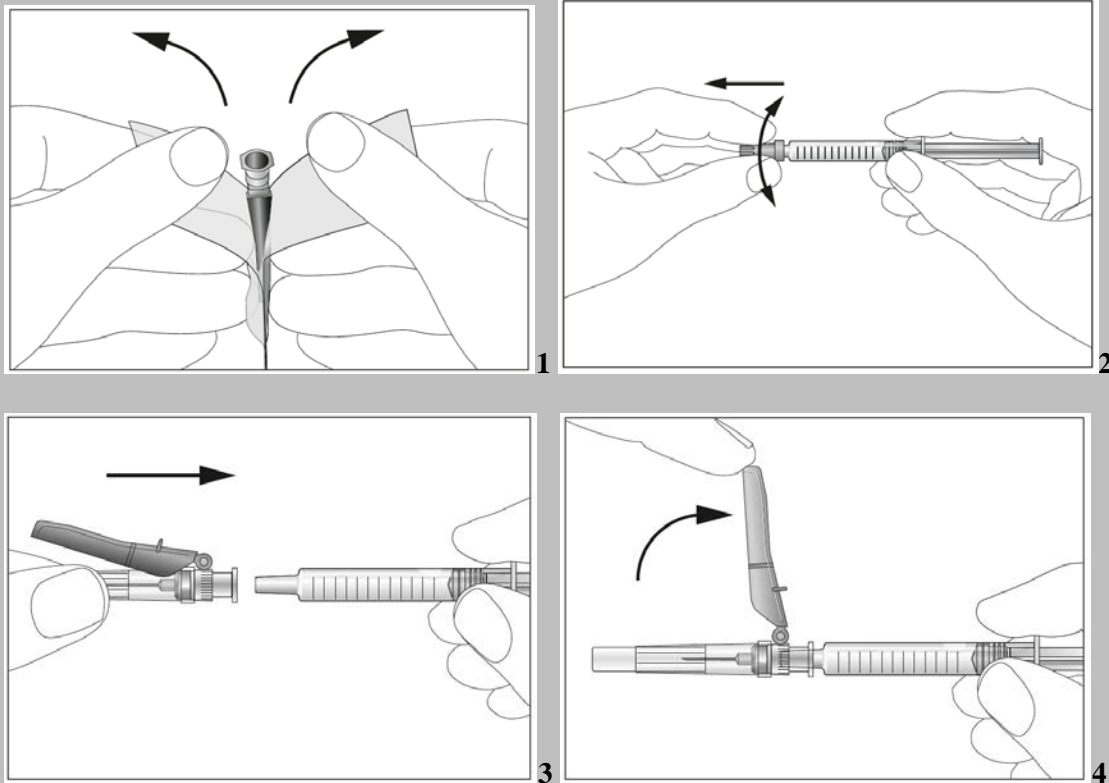

### How to prepare for your injection

Before you give yourself an Biopoin injection, you must do the following:

1. Hold the syringe and gently remove the cover from the needle without twisting. Pull straight as shown in picture 5. Do not touch the needle or push the plunger.
2. You may notice small air bubbles in the pre-filled syringe. If there are air bubbles present, gently tap the syringe with your fingers until the air bubbles rise to the top of the syringe. With the syringe pointing upwards, expel all air from the syringe by pushing the plunger slowly upwards.
3. The syringe has a scale on the syringe barrel. Push the plunger up to the number (IU) on the syringe that matches the dose of Biopoin that your doctor prescribed.
4. Check again to make sure the correct dose of Biopoin is in the syringe.
5. You can now use the pre-filled syringe.

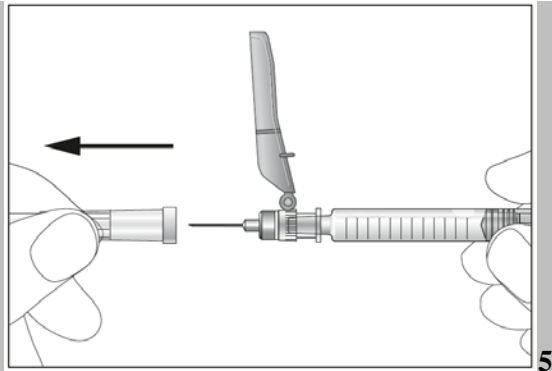

5

### Where your injection should be given

The most suitable places to inject yourself are:

- the top of your thighs,
- the abdomen, except for the area around the navel (see grey areas in picture 6).

If someone else is injecting you, they can also use the back and side of your upper arms (see grey areas in picture 7).

It is better to change the injection site every day to avoid the risk of soreness at any one site.

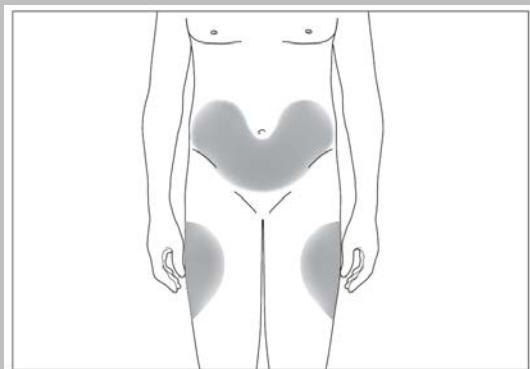

6

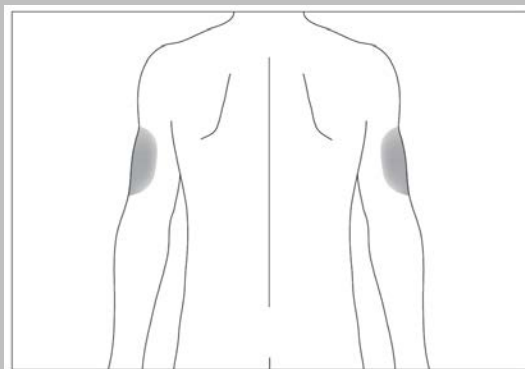

7

### How you should inject yourself

1. Disinfect the injection site on the skin by using an alcohol wipe and pinch the skin between your thumb and forefinger, without squeezing it (see picture 8).
2. Put the needle fully into the skin as shown by your doctor or nurse. The angle between the syringe and skin should not be too narrow (at least 45°, see pictures 9 and 10).
3. Inject the liquid into the tissue slowly and evenly, always keeping your skin pinched (see picture 11).
4. After injecting the liquid, remove the needle and let go of your skin.
5. Press the injection site with a piece of gauze bandage or a sterile gauze swab for several seconds.
6. Push the safety shield towards the needle (see picture 12).
7. Position the safety shield approximately 45° against a flat surface (see picture 13).
8. Press down the needle with a firm, quick motion until a distinct audible click is heard (see picture 14).
9. Confirm visually that the needle is fully engaged in the safety shield under the lock (see picture 15).
10. Only use each syringe for one injection. Do not use any Biopoin that is left in the syringe.

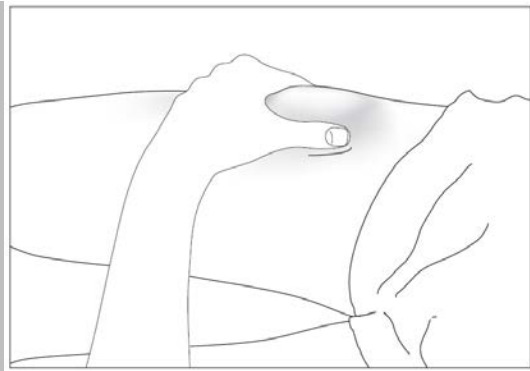

8

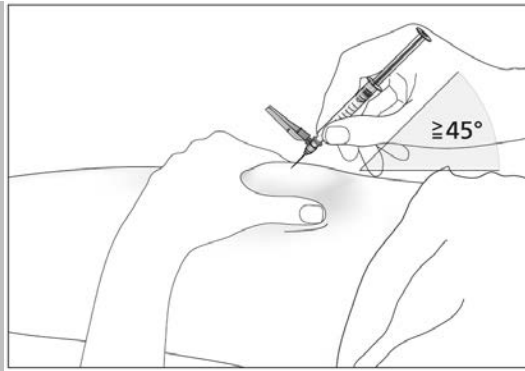

9

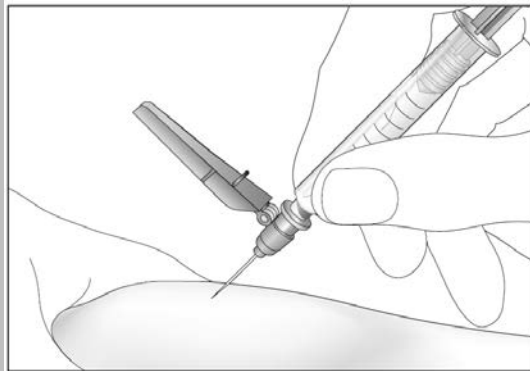

10

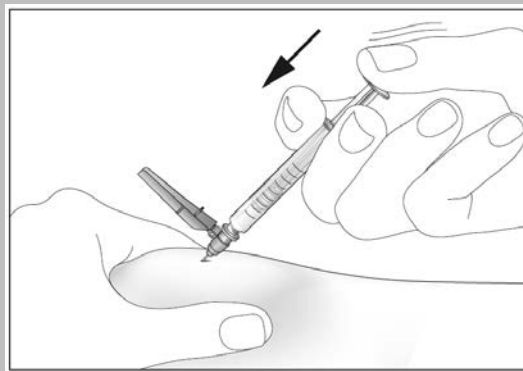

11

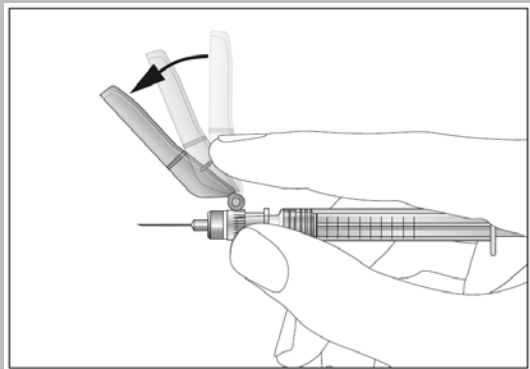

12

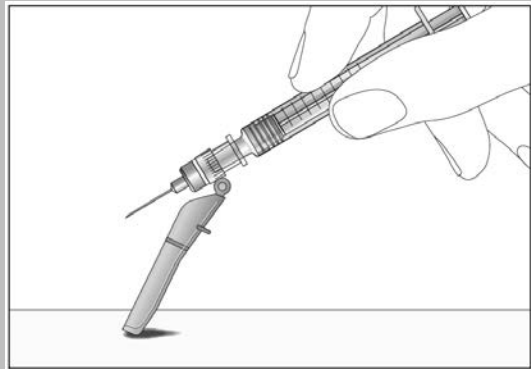

13

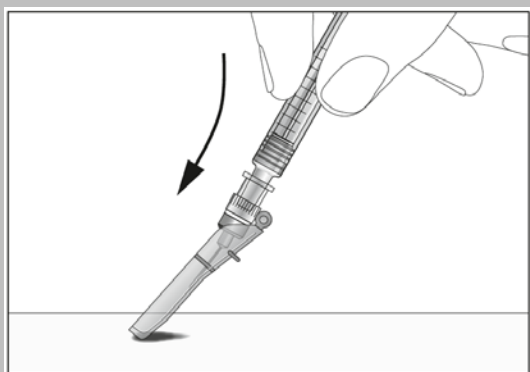

14



15

### Remember

If you have any problems, please ask your doctor or nurse for help and advice.

### Disposing of used syringes

- Put used syringes into the puncture-proof container and keep this container out of the sight and reach of children.
- Dispose of the full puncture-proof container as instructed by your doctor, pharmacist or nurse.
- Never put the syringes that you have used into your normal household rubbish bin.

## 7. Information for injecting yourself

This section contains information on how to give yourself an injection of Biopoin under the skin. It is important that you do not try to give yourself the injection unless you have received special training from your doctor or nurse. If you are not sure about giving yourself the injection or you have any questions, please ask your doctor or nurse for help.

### How Biopoin is used

You will need to give yourself the injection into the tissue just under the skin. This is known as a subcutaneous injection.

### Equipment that you need

To give yourself an injection into the tissue under the skin you will need:

- a pre-filled syringe of Biopoin,
- an alcohol wipe,
- a piece of gauze bandage or a sterile gauze swab.

### What you should do before your injection

1. Take one blister with a pre-filled syringe out of the refrigerator.
2. Open the blister and take the pre-filled syringe and the needle container out of the blister. Do not pick up the pre-filled syringe by the plunger or tip cap.
3. Check the expiry date on the pre-filled syringe label (EXP). Do not use it if the date has passed the last day of the month shown.
4. Check the appearance of Biopoin. It must be a clear and colourless liquid. If there are particles in it or if it is cloudy, you must not use it.
5. There is a cap at the end of the needle container. Break the labelled seal and remove the cap (see picture 1).
6. Remove the tip cap from the pre-filled syringe (see picture 2).
7. Attach the needle to the syringe (see picture 3). Do not remove the needle cover at this time.
8. For a more comfortable injection, let the pre-filled syringe stand for 30 minutes to reach room temperature (not above 25 °C) or hold the pre-filled syringe gently in your hand for a few minutes. Do **not** warm Biopoin in any other way (for example, do not warm it in a microwave or in hot water).
9. Do **not** remove the needle cover from the syringe until you are ready to inject.
10. Find a comfortable, well-lit place. Put everything you need within easy reach (the Biopoin pre-filled syringe, an alcohol wipe and a piece of gauze bandage or a sterile gauze swab).
11. **Wash your hands thoroughly.**

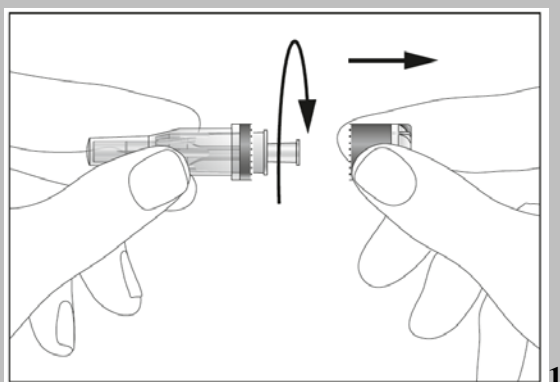

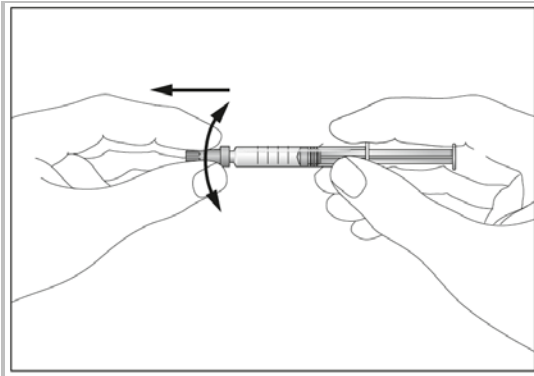

2

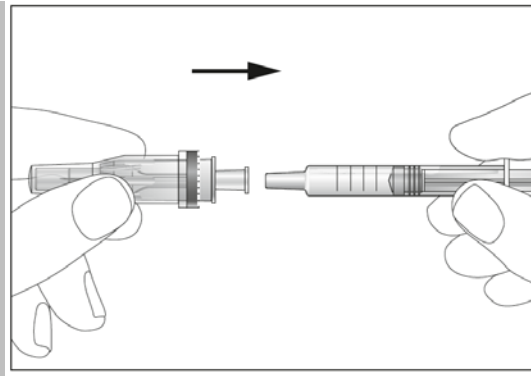

3

### How to prepare for your injection

Before you give yourself an Biopoin injection, you must do the following:

1. Hold the syringe and gently remove the cover from the needle without twisting. Pull straight as shown in picture 4. The needle is surrounded by a retractable needle shield. Do not touch the needle or needle shield or push the plunger (see picture 5).
2. You may notice small air bubbles in the pre-filled syringe. If there are air bubbles present, gently tap the syringe with your fingers until the air bubbles rise to the top of the syringe. With the syringe pointing upwards, expel all air from the syringe by pushing the plunger slowly upwards.
3. The syringe has a scale on the syringe barrel. Push the plunger up to the number (IU) on the syringe that matches the dose of Biopoin that your doctor prescribed.
4. Check again to make sure the correct dose of Biopoin is in the syringe.
5. You can now use the pre-filled syringe.

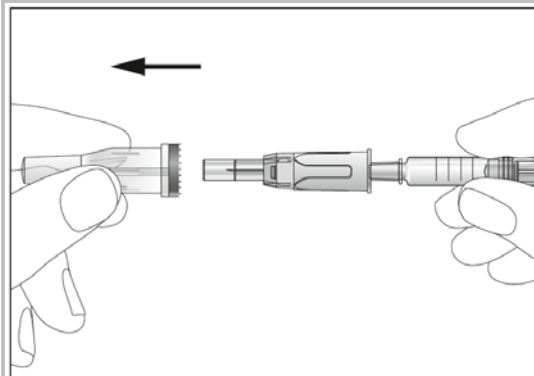

4

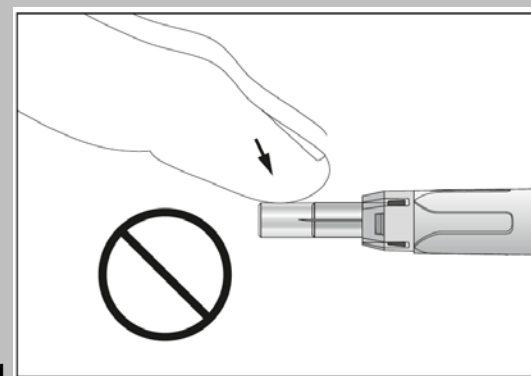

5

### Where your injection should be given

The most suitable places to inject yourself are:

- the top of your thighs,
- the abdomen, except for the area around the navel (see grey areas in picture 6).

If someone else is injecting you, they can also use the back and side of your upper arms (see grey areas in picture 7).

It is better to change the injection site every day to avoid the risk of soreness at any one site.

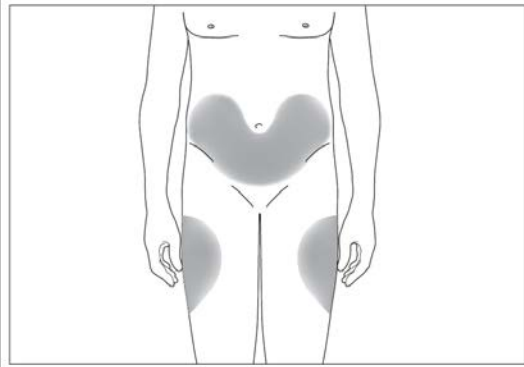

6

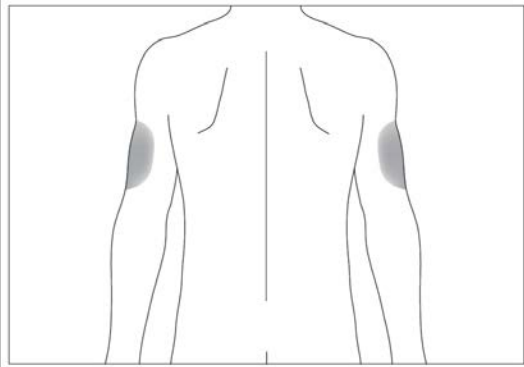

7

### How you should inject yourself

1. Disinfect the injection site on the skin by using an alcohol wipe and pinch the skin between your thumb and forefinger, without squeezing it (see picture 8).
2. Put the shielded needle without hesitation and in one continuous motion fully into the skin as shown by your doctor or nurse. The angle between the syringe and skin should not be too narrow (at least  $45^\circ$ , see picture 9). The needle shield will retract completely when you insert the needle into the skin (see picture 10).
3. Inject the liquid into the tissue slowly and evenly, always keeping your skin pinched (see picture 11).
4. After injecting the liquid, remove the needle and let go of your skin. The needle will be shielded and locked automatically so that you can not prick yourself (see picture 12).
5. Press the injection site with a piece of gauze bandage or a sterile gauze swab for several seconds.
6. Only use each syringe for one injection. Do not use any Biopoin that is left in the syringe.

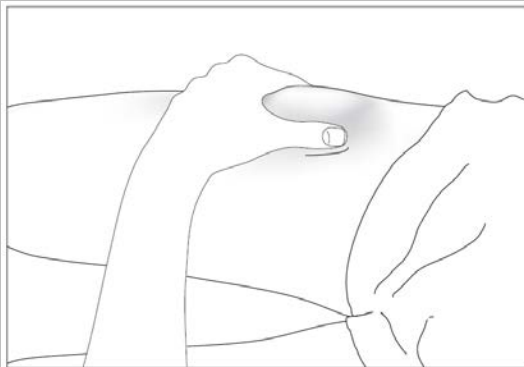

8

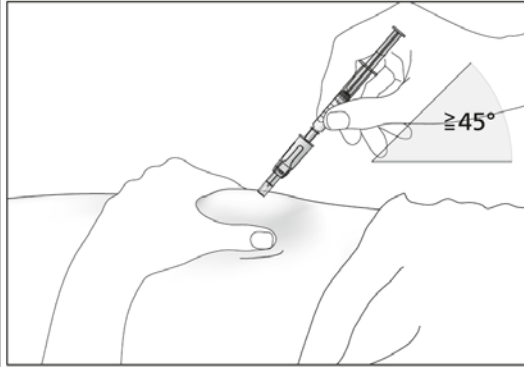

9

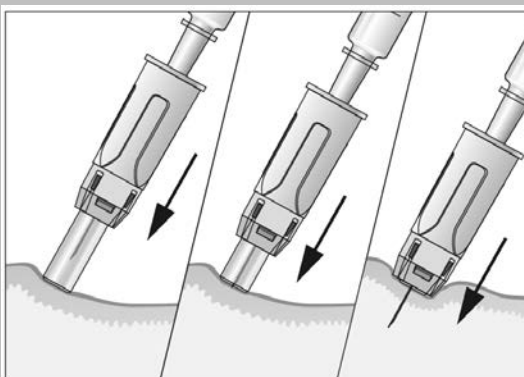

10

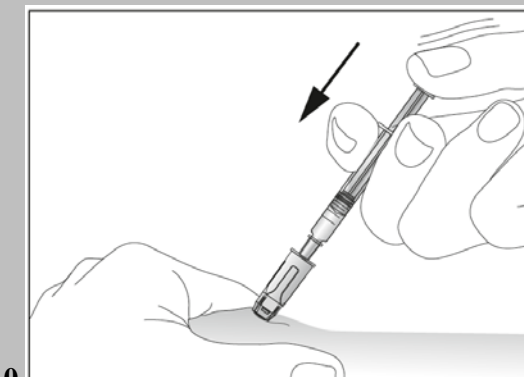

11

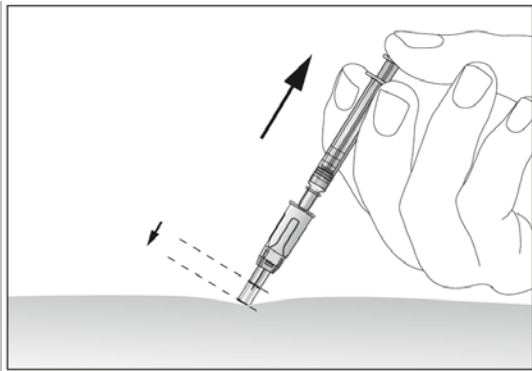

12

**Remember**

If you have any problems, please ask your doctor or nurse for help and advice.

**Disposing of used syringes**

The safety device prevents needle stick injuries after use, so no special precautions for disposal are required. Dispose of syringes with a safety device as instructed by your doctor, pharmacist or nurse.