

ANNEX I

SUMMARY OF PRODUCT CHARACTERISTICS

1. NAME OF THE MEDICINAL PRODUCT

Fulphila 6 mg solution for injection in pre-filled syringe

2. QUALITATIVE AND QUANTITATIVE COMPOSITION

Each pre-filled syringe contains 6 mg of pegfilgrastim* in 0.6 mL solution for injection. The concentration is 10 mg/mL based on protein only**.

*Produced in *Escherichia coli* cells by recombinant DNA technology followed by conjugation with polyethylene glycol (PEG).

** The concentration is 20 mg/mL if the PEG moiety is included.

The potency of this product should not be compared to the potency of another pegylated or non-pegylated protein of the same therapeutic class. For more information, see section 5.1

Excipient with known effect

Each pre-filled syringe contains 30 mg sorbitol (E420) (see section 4.4).

For the full list of excipients, see section 6.1.

3. PHARMACEUTICAL FORM

Solution for injection (injection).

Clear, colourless solution for injection.

4. CLINICAL PARTICULARS

4.1 Therapeutic indications

Reduction in the duration of neutropenia and the incidence of febrile neutropenia in adult patients treated with cytotoxic chemotherapy for malignancy (with the exception of chronic myeloid leukaemia and myelodysplastic syndromes).

4.2 Posology and method of administration

Pegfilgrastim therapy should be initiated and supervised by physicians experienced in oncology and/or haematology.

Posology

One 6 mg dose (a single pre-filled syringe) of pegfilgrastim is recommended for each chemotherapy cycle, given at least 24 hours after cytotoxic chemotherapy.

Special populations

Patients with renal impairment

No dose change is recommended in patients with renal impairment, including those with end stage renal disease.

Paediatric population

The safety and efficacy of pegfilgrastim in children has not yet been established. Currently available data are described in sections 4.8, 5.1 and 5.2 but no recommendation on a posology can be made.

Method of administration

Fulphila is injected subcutaneously. The injections should be given into the thigh, abdomen or upper arm.

For instructions on handling of the medicinal product before administration, see section 6.6.

4.3 Contraindications

Hypersensitivity to the active substance or to any of the excipients listed in section 6.1.

4.4 Special warnings and precautions for use

Traceability

In order to improve the traceability of biological medicinal products, the name and the batch number of the administered product should be clearly recorded.

Patients with myeloid leukaemia or myelodysplastic syndromes

Limited clinical data suggest a comparable effect on time to recovery of severe neutropenia for pegfilgrastim to filgrastim in patients with *de novo* acute myeloid leukaemia (AML) (see section 5.1). However, the long-term effects of pegfilgrastim have not been established in AML; therefore, it should be used with caution in this patient population.

Granulocyte-colony stimulating factor (G-CSF) can promote growth of myeloid cells *in vitro* and similar effects may be seen on some non-myeloid cells *in vitro*.

The safety and efficacy of pegfilgrastim have not been investigated in patients with myelodysplastic syndrome, chronic myelogenous leukaemia, and in patients with secondary AML; therefore, it should not be used in such patients. Particular care should be taken to distinguish the diagnosis of blast transformation of chronic myeloid leukaemia from AML.

The safety and efficacy of pegfilgrastim administration in *de novo* AML patients aged < 55 years with cytogenetics t(15;17) have not been established.

General

The safety and efficacy of pegfilgrastim have not been investigated in patients receiving high dose chemotherapy. This medicinal product should not be used to increase the dose of cytotoxic chemotherapy beyond established dose regimens.

Pulmonary adverse events

Pulmonary adverse reactions, in particular interstitial pneumonia, have been reported after G-CSF administration. Patients with a recent history of pulmonary infiltrates or pneumonia may be at higher risk (see section 4.8).

The onset of pulmonary signs such as cough, fever, and dyspnoea in association with radiological signs of pulmonary infiltrates, and deterioration in pulmonary function along with increased neutrophil count may be preliminary signs of acute respiratory distress syndrome (ARDS). In such circumstances pegfilgrastim should be discontinued at the discretion of the physician and the appropriate treatment given (see section 4.8).

Glomerulonephritis

Glomerulonephritis has been reported in patients receiving filgrastim and pegfilgrastim. Generally, events of glomerulonephritis resolved after dose reduction or withdrawal of filgrastim and pegfilgrastim. Urinalysis monitoring is recommended.

Capillary leak syndrome

Capillary leak syndrome has been reported after G-CSF administration and is characterised by hypotension, hypoalbuminaemia, oedema and haemoconcentration. Patients who develop symptoms of capillary leak syndrome should be closely monitored and receive standard symptomatic treatment, which may include a need for intensive care (see section 4.8).

Splenomegaly and splenic rupture

Generally asymptomatic cases of splenomegaly and cases of splenic rupture, including some fatal cases, have been reported following administration of pegfilgrastim (see section 4.8). Therefore, spleen size should be carefully monitored (e.g. clinical examination, ultrasound). A diagnosis of splenic rupture should be considered in patients reporting left upper abdominal pain or shoulder tip pain.

Thrombocytopenia and anaemia

Treatment with pegfilgrastim alone does not preclude thrombocytopenia and anaemia because full dose myelosuppressive chemotherapy is maintained on the prescribed schedule. Regular monitoring of platelet count and haematocrit is recommended. Special care should be taken when administering single or combination chemotherapeutic agents which are known to cause severe thrombocytopenia.

Myelodysplastic syndrome and acute myeloid leukaemia in breast and lung cancer patients

In the post-marketing observational study setting, pegfilgrastim in conjunction with chemotherapy and/or radiotherapy has been associated with development of myelodysplastic syndrome (MDS) and AML in breast and lung cancer patients (see section 4.8). Monitor breast and lung cancer patients for signs and symptoms of MDS/AML.

Sickle cell anaemia

Sickle cell crises have been associated with the use of pegfilgrastim in patients with sickle cell trait or sickle cell disease (see section 4.8). Therefore, physicians should use caution when prescribing pegfilgrastim in patients with sickle cell trait or sickle cell disease, should monitor appropriate clinical parameters and laboratory status and be attentive to the possible association of this medicinal product with splenic enlargement and vaso-occlusive crisis.

Leukocytosis

White blood cell (WBC) counts of $100 \times 10^9/L$ or greater have been observed in less than 1 % of patients receiving pegfilgrastim. No adverse events directly attributable to this degree of leukocytosis have been reported. Such elevation in white blood cells is transient, typically seen 24 to 48 hours after administration and is consistent with the pharmacodynamic effects of this medicinal product. Consistent with the clinical effects and the potential for leukocytosis, a WBC count should be performed at regular intervals during therapy. If leukocyte counts exceed $50 \times 10^9/L$ after the expected nadir, this medicinal product should be discontinued immediately.

Hypersensitivity

Hypersensitivity, including anaphylactic reactions, occurring on initial or subsequent treatment have been reported in patients treated with pegfilgrastim. Permanently discontinue pegfilgrastim in patients with clinically significant hypersensitivity. Do not administer pegfilgrastim to patients with a history of hypersensitivity to pegfilgrastim or filgrastim. If a serious allergic reaction occurs, appropriate therapy should be administered, with close patient follow-up over several days.

Stevens-Johnson syndrome

Stevens-Johnson syndrome (SJS), which can be life-threatening or fatal, has been reported rarely in association with pegfilgrastim treatment. If the patient has developed SJS with the use of pegfilgrastim, treatment with pegfilgrastim must not be restarted in this patient at any time.

Immunogenicity

As with all therapeutic proteins, there is a potential for immunogenicity. Rates of generation of antibodies against pegfilgrastim is generally low. Binding antibodies do occur as expected with all biologics; however, they have not been associated with neutralising activity at present.

Aortitis

Aortitis has been reported after G-CSF administration in healthy subjects and in cancer patients. The symptoms experienced included fever, abdominal pain, malaise, back pain and increased inflammatory markers (e.g. C-reactive protein and white blood cell count). In most cases aortitis was diagnosed by CT scan and generally resolved after withdrawal of G-CSF. See also section 4.8.

Other warnings

The safety and efficacy of pegfilgrastim for the mobilisation of blood progenitor cells in patients or healthy donors has not been adequately evaluated.

Increased haematopoietic activity of the bone marrow in response to growth factor therapy has been associated with transient positive bone imaging findings. This should be considered when interpreting bone-imaging results.

Excipients

Sorbitol

This medicinal product contains 30 mg sorbitol in each pre-filled syringe which is equivalent to 50 mg/mL. The additive effect of concomitantly administered products containing sorbitol (or fructose) and dietary intake of sorbitol (or fructose) should be taken into account.

Sodium

This medicinal product contains less than 1 mmol sodium (23 mg) per 6 mg dose, that is to say essentially 'sodium-free'.

4.5 Interaction with other medicinal products and other forms of interaction

Due to the potential sensitivity of rapidly dividing myeloid cells to cytotoxic chemotherapy, pegfilgrastim should be administered at least 24 hours after administration of cytotoxic chemotherapy. In clinical trials, pegfilgrastim has been safely administered 14 days before chemotherapy.

Concomitant use of pegfilgrastim with any chemotherapy agent has not been evaluated in patients. In animal models concomitant administration of pegfilgrastim and 5-fluorouracil (5-FU) or other antimetabolites has been shown to potentiate myelosuppression.

Possible interactions with other haematopoietic growth factors and cytokines have not been specifically investigated in clinical trials.

The potential for interaction with lithium, which also promotes the release of neutrophils, has not been specifically investigated. There is no evidence that such an interaction would be harmful.

The safety and efficacy of pegfilgrastim have not been evaluated in patients receiving chemotherapy associated with delayed myelosuppression e.g., nitrosoureas.

Specific interaction or metabolism studies have not been performed, however, clinical trials have not indicated an interaction of pegfilgrastim with any other medicinal products.

4.6 Fertility, pregnancy and lactation

Pregnancy

There are no or limited amount of data from the use of pegfilgrastim in pregnant women. Studies in animals have shown reproductive toxicity (see section 5.3). Pegfilgrastim is not recommended during pregnancy and in women of childbearing potential not using contraception.

Breast-feeding

There is insufficient information on the excretion of pegfilgrastim / metabolites in human milk, a risk to the newborns/infants cannot be excluded. A decision must be made whether to discontinue breast-feeding or to discontinue/abstain from Fulphila therapy taking into account the benefit of breast-feeding for the child and the benefit of therapy for the woman.

Fertility

Pegfilgrastim did not affect reproductive performance or fertility in male or female rats at cumulative weekly doses approximately 6 to 9 times higher than the recommended human dose (based on body surface area) (see section 5.3).

4.7 Effects on ability to drive and use machines

Pegfilgrastim has no or negligible influence on the ability to drive and use machines.

4.8 Undesirable effects

Summary of the safety profile

The most frequently reported adverse reactions were bone pain (very common [$\geq 1/10$]) and musculoskeletal pain (common [$\geq 1/100$ to $< 1/10$]). Bone pain was generally of mild to moderate severity, transient and could be controlled in most patients with standard analgesics.

Hypersensitivity-type reactions, including skin rash, urticaria, angioedema, dyspnoea, erythema, flushing, and hypotension occurred on initial or subsequent treatment with pegfilgrastim (uncommon [$\geq 1/1\ 000$ to $< 1/100$]). Serious allergic reactions, including anaphylaxis can occur in patients receiving pegfilgrastim (uncommon) (see section 4.4).

Capillary Leak Syndrome, which can be life-threatening if treatment is delayed, has been reported as uncommon ($\geq 1/1\ 000$ to $< 1/100$) in cancer patients undergoing chemotherapy following administration of G-CSF; see section 4.4 and section "Description of selected adverse reactions" below.

Splenomegaly, generally asymptomatic, is uncommon.

Splenic rupture including some fatal cases is uncommonly reported following administration of pegfilgrastim (see section 4.4).

Uncommon pulmonary adverse reactions including interstitial pneumonia, pulmonary oedema, pulmonary infiltrates and pulmonary fibrosis have been reported. Uncommonly, cases have resulted in respiratory failure or ARDS, which may be fatal (see section 4.4).

Isolated cases of sickle cell crises have been reported in patients with sickle cell trait or sickle cell disease (uncommon in sickle cell patients) (see section 4.4).

Tabulated list of adverse reactions

The data in the table below describe adverse reactions reported from clinical trials and spontaneous reporting. Within each frequency grouping, adverse reactions are presented in order of decreasing seriousness.

MedDRA system organ class	Adverse reactions			
	Very common (≥ 1/10)	Common (≥ 1/100 to < 1/10)	Uncommon (≥ 1/1 000 to < 1/100)	Rare (≥ 1/10 000 to < 1/1 000)
Neoplasms benign, malignant and unspecified (incl cysts and polyps)			Myelodysplastic syndrome ¹ Acute myeloid leukaemia ¹	
Blood and lymphatic system disorders		Thrombocytopenia ¹ Leukocytosis ¹	Sickle cell anaemia with crisis ² Splénomegaly ² Splenic rupture ²	
Immune system disorders			Hypersensitivity reactions Anaphylaxis	
Metabolism and nutrition disorders			Elevations in uric acid	
Nervous system disorders	Headache ¹			
Vascular disorders			Capillary leak syndrome ¹	Aortitis

MedDRA system organ class	Adverse reactions			
	Very common (≥ 1/10)	Common (≥ 1/100 to < 1/10)	Uncommon (≥ 1/1 000 to < 1/100)	Rare (≥ 1/10 000 to < 1/1 000)
Respiratory, thoracic and mediastinal disorders			Acute Respiratory Distress Syndrome ² Pulmonary adverse reactions (interstitial pneumonia, pulmonary oedema, pulmonary infiltrates and pulmonary fibrosis) Haemoptysis	Pulmonary haemorrhage
Gastrointestinal disorders	Nausea ¹			
Skin and subcutaneous tissue disorders			Sweet's syndrome (acute febrile neutrophilic dermatosis) ^{1,2} Cutaneous vasculitis ^{1,2}	Stevens-Johnson syndrome
Musculoskeletal and connective tissue disorders	Bone pain	Musculoskeletal pain (myalgia, arthralgia, pain in extremity, back pain, musculo-skeletal pain, neck pain)		
Renal and urinary disorders			Glomerulonephritis ²	
General disorders and administration site conditions		Injection site pain ¹ Non-cardiac chest pain	Injection site reactions ²	
Investigations			Elevations in lactate dehydrogenase and alkaline phosphatase ¹ Transient elevations in LFT's for ALT or AST ¹	

¹ See section "Description of selected adverse reactions" below.

² This adverse reaction was identified through post-marketing surveillance but not observed in randomised, controlled clinical trials in adults. The frequency category was estimated from a statistical calculation based upon 1 576 patients receiving pegfilgrastim in nine randomised clinical trials.

Description of selected adverse reactions

Uncommon cases of Sweet's syndrome have been reported, although in some cases underlying haematological malignancies may play a role.

Uncommon events of cutaneous vasculitis have been reported in patients treated with pegfilgrastim. The mechanism of vasculitis in patients receiving pegfilgrastim is unknown.

Injection site reactions, including injection site erythema (uncommon) as well as injection site pain (common) have occurred on initial or subsequent treatment with pegfilgrastim.

Common cases of leukocytosis (White Blood Count [WBC] > 100 × 10⁹/l) have been reported (see section 4.4).

Reversible, mild to moderate elevations in uric acid and alkaline phosphatase, with no associated clinical effects, were uncommon; reversible, mild to moderate elevations in lactate dehydrogenase, with no associated clinical effects, were uncommon in patients receiving pegfilgrastim following cytotoxic chemotherapy.

Nausea and headaches were very commonly observed in patients receiving chemotherapy.

Uncommon elevations in liver function tests (LFTs) for alanine aminotransferase (ALT) or aspartate aminotransferase (AST), have been observed in patients after receiving pegfilgrastim following cytotoxic chemotherapy. These elevations are transient and return to baseline.

An increased risk of MDS/AML following treatment with pegfilgrastim in conjunction with chemotherapy and/or radiotherapy has been observed in an epidemiological study in breast and lung cancer patients (see section 4.4).

Common cases of thrombocytopenia have been reported.

Cases of capillary leak syndrome have been reported in the post marketing setting with G-CSF use. These have generally occurred in patients with advanced malignant diseases, sepsis, taking multiple chemotherapy medicinal products or undergoing apheresis (see section 4.4).

Paediatric population

The experience in children and adolescents is limited. A higher frequency of serious adverse reactions in younger children aged 0-5 years (92 %) has been observed compared to older children aged 6-11 and 12-21 years respectively (80 % and 67 %) and adults. The most common adverse reaction reported was bone pain (see sections 5.1 and 5.2).

Reporting of suspected adverse reactions

Reporting suspected adverse reactions after authorisation of the medicinal product is important. It allows continued monitoring of the benefit/risk balance of the medicinal product. Healthcare professionals are asked to report any suspected adverse reactions via **the national reporting system** listed in [Appendix V](#).

4.9 Overdose

Single doses of 300 mcg/kg have been administered subcutaneously to a limited number of healthy volunteers and patients with non-small cell lung cancer without serious adverse reactions. The adverse events were similar to those in subjects receiving lower doses of pegfilgrastim.

5. PHARMACOLOGICAL PROPERTIES

5.1 Pharmacodynamic properties

Pharmacotherapeutic group: immunostimulants, colony stimulating factors; ATC Code: L03AA13

Fulphila is a biosimilar medicinal product. Detailed information is available on the website of the European Medicines Agency <http://www.ema.europa.eu>.

Human granulocyte-colony stimulating factor (G-CSF) is a glycoprotein, which regulates the production and release of neutrophils from the bone marrow. Pegfilgrastim is a covalent conjugate of recombinant human G-CSF (r-metHuG-CSF) with a single 20 kd polyethylene glycol (PEG) molecule. Pegfilgrastim is a sustained duration form of filgrastim due to decreased renal clearance. Pegfilgrastim and filgrastim have been shown to have identical modes of action, causing a marked increase in peripheral blood neutrophil counts within 24 hours, with minor increases in monocytes and/or lymphocytes. Similarly to filgrastim, neutrophils produced in response to pegfilgrastim show normal or enhanced function as demonstrated by tests of chemotactic and phagocytic function. As with other haematopoietic growth factors, G-CSF has shown *in vitro* stimulating properties on human endothelial cells. G-CSF can promote growth of myeloid cells, including malignant cells, *in vitro* and similar effects may be seen on some non-myeloid cells *in vitro*.

In two randomised, double-blind, pivotal studies in patients with high risk stage II-IV breast cancer undergoing myelosuppressive chemotherapy consisting of doxorubicin and docetaxel, use of pegfilgrastim, as a single once per cycle dose, reduced the duration of neutropenia and the incidence of febrile neutropenia similarly to that observed with daily administrations of filgrastim (a median of 11 daily administrations). In the absence of growth factor support, this regimen has been reported to result in a mean duration of grade 4 neutropenia of 5 to 7 days, and a 30-40 % incidence of febrile neutropenia. In one study (n = 157), which used a 6 mg fixed dose of pegfilgrastim the mean duration of grade 4 neutropenia for the pegfilgrastim group was 1.8 days compared with 1.6 days in the filgrastim group (difference 0.23 days, 95 % CI -0.15, 0.63). Over the entire study, the rate of febrile neutropenia was 13 % of pegfilgrastim-treated patients compared with 20 % of filgrastim-treated patients (difference 7 %, 95 % CI of -19 %, 5 %). In a second study (n = 310), which used a weight-adjusted dose (100 mcg /kg), the mean duration of grade 4 neutropenia for the pegfilgrastim group was 1.7 days, compared with 1.8 days in the filgrastim group (difference 0.03 days, 95 % CI -0.36, 0.30). The overall rate of febrile neutropenia was 9 % of patients treated with pegfilgrastim and 18 % of patients treated with filgrastim (difference 9 %, 95 % CI of -16.8 %, -1.1 %).

In a placebo-controlled, double-blind study in patients with breast cancer the effect of pegfilgrastim on the incidence of febrile neutropenia was evaluated following administration of a chemotherapy regimen associated with a febrile neutropenia rate of 10-20 % (docetaxel 100 mg/m² every 3 weeks for 4 cycles). Nine hundred and twenty-eight patients were randomised to receive either a single dose of pegfilgrastim or placebo approximately 24 hours (day 2) after chemotherapy in each cycle. The incidence of febrile neutropenia was lower for patients randomised to receive pegfilgrastim compared with placebo (1 % versus 17 %, p < 0.001). The incidence of hospitalisations and IV anti-infective use associated with a clinical diagnosis of febrile neutropenia was lower in the pegfilgrastim group compared with placebo (1 % versus 14 %, p < 0.001; and 2 % versus 10 %, p < 0.001).

A small (n = 83), phase II, randomised, double-blind study in patients receiving chemotherapy for *de novo* acute myeloid leukaemia compared pegfilgrastim (single dose of 6 mg) with filgrastim, administered during induction chemotherapy. Median time to recovery from severe neutropenia was estimated as 22 days in both treatment groups. Long-term outcome was not studied (see section 4.4).

In a phase II (n = 37) multicentre, randomised, open-label study of paediatric sarcoma patients receiving 100 mcg/kg pegfilgrastim following cycle 1 of vincristine, doxorubicin and cyclophosphamide (VAdriaC/IE) chemotherapy, a longer duration of severe neutropenia (neutrophils < 0.5 × 10⁹/L) was observed in younger children aged 0-5 years (8.9 days) compared to older children aged 6-11 years and 12-21 years (6 days and 3.7 days, respectively) and adults. Additionally a higher incidence of febrile neutropenia was observed in younger children aged 0-5 years (75 %) compared to older children aged 6-11 years and 12-21 years (70 % and 33 %, respectively) and adults (see sections 4.8 and 5.2).

5.2 Pharmacokinetic properties

After a single subcutaneous dose of pegfilgrastim, the peak serum concentration of pegfilgrastim occurs at 16 to 120 hours after dosing and serum concentrations of pegfilgrastim are maintained

during the period of neutropenia after myelosuppressive chemotherapy. The elimination of pegfilgrastim is non-linear with respect to dose; serum clearance of pegfilgrastim decreases with increasing dose. Pegfilgrastim appears to be mainly eliminated by neutrophil-mediated clearance, which becomes saturated at higher doses. Consistent with a self-regulating clearance mechanism, the serum concentration of pegfilgrastim declines rapidly at the onset of neutrophil recovery (see figure 1).

Figure 1. Profile of median pegfilgrastim serum concentration and Absolute Neutrophil Count (ANC) in chemotherapy treated patients after a single 6 mg injection

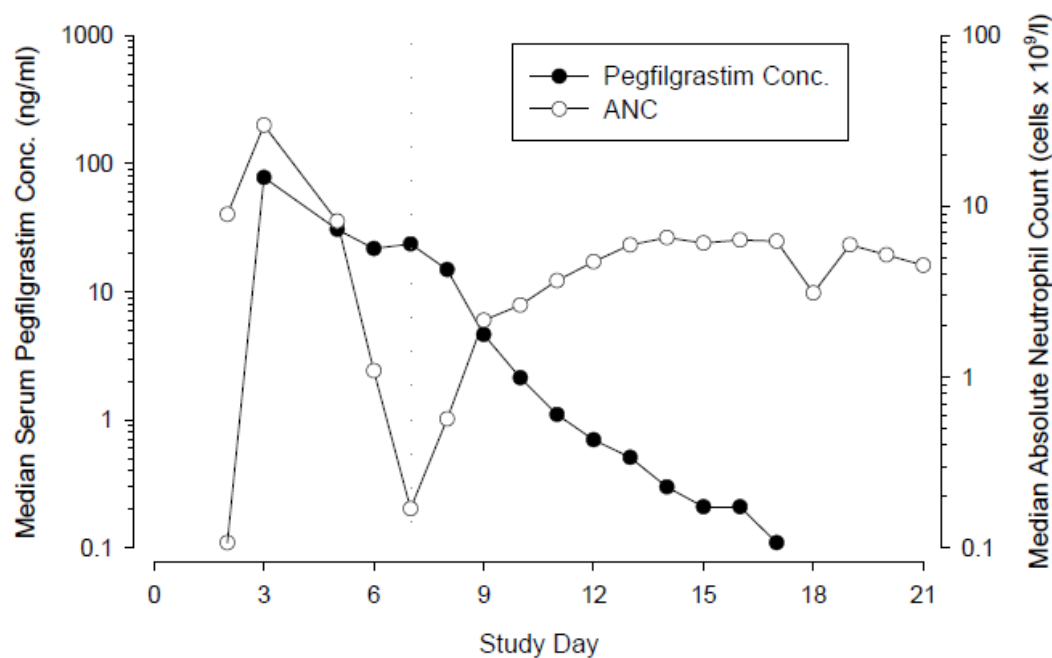

Due to the neutrophil-mediated clearance mechanism, the pharmacokinetics of pegfilgrastim is not expected to be affected by renal or hepatic impairment. In an open label, single dose study (n = 31) various stages of renal impairment, including end-stage renal disease, had no impact on the pharmacokinetics of pegfilgrastim.

Elderly

Limited data indicate that the pharmacokinetics of pegfilgrastim in elderly subjects (> 65 years) is similar to that in adults.

Paediatric population

The pharmacokinetics of pegfilgrastim were studied in 37 paediatric patients with sarcoma, who received 100 mcg/kg pegfilgrastim after the completion of VAdriaC/IE chemotherapy. The youngest age group (0-5 years) had a higher mean exposure to pegfilgrastim (Area Under Curve (AUC)) (\pm Standard Deviation) (47.9 ± 22.5 mcg·hr/mL) than older children aged 6-11 years and 12-21 years (22.0 ± 13.1 mcg·hr/mL and 29.3 ± 23.2 mcg·hr/mL, respectively) (see section 5.1). With the exception of the youngest age group (0-5 years), the mean AUC in paediatric subjects appeared similar to that for adult patients with high-risk stage II-IV breast cancer and receiving 100 mcg/kg pegfilgrastim after the completion of doxorubicin/docetaxel (see sections 4.8 and 5.1).

5.3 Preclinical safety data

Preclinical data from conventional studies of repeated dose toxicity revealed the expected pharmacological effects including increases in leukocyte count, myeloid hyperplasia in bone marrow, extramedullary haematopoiesis and splenic enlargement.

There were no adverse effects observed in offspring from pregnant rats given pegfilgrastim subcutaneously, but in rabbits pegfilgrastim has been shown to cause embryo/foetal toxicity (embryo loss) at cumulative doses approximately 4 times the recommended human dose, which were not seen when pregnant rabbits were exposed to the recommended human dose. In rat studies, it was shown that pegfilgrastim may cross the placenta. Studies in rats indicated that reproductive performance, fertility, oestrous cycling, days between pairing and coitus, and intrauterine survival were unaffected by pegfilgrastim given subcutaneously. The relevance of these findings for humans is not known.

6. PHARMACEUTICAL PARTICULARS

6.1 List of excipients

Sodium acetate*

Sorbitol (E420)

Polysorbate 20

Water for injections

*Sodium acetate is formed by titrating glacial acetic acid with sodium hydroxide.

6.2 Incompatibilities

This medicinal product must not be mixed with other medicinal products, particularly with 0.9 % sodium chloride solution.

6.3 Shelf life

3 years.

6.4 Special precautions for storage

Store in a refrigerator (2 °C – 8 °C).

Fulphila may be exposed to room temperature (not above 30 °C) for a maximum single period of up to 72 hours. Fulphila left at room temperature for more than 72 hours should be discarded.

Do not freeze. Accidental exposure to freezing temperatures for a single period of less than 24 hours does not adversely affect the stability of Fulphila.

Keep the container in the outer carton in order to protect from light.

6.5 Nature and contents of container

Pre-filled syringe (Type I glass), with a fluorotec-coated bromobutyl rubber stopper and a stainless steel needle with or without an automatic needle guard.

Pack size of one pre-filled syringe, in blistered packaging.

6.6 Special precautions for disposal and other handling

Before administration, Fulphila solution should be inspected visually for particulate matter. Only a solution that is clear and colourless should be injected.

Excessive shaking may aggregate pegfilgrastim, rendering it biologically inactive.

Allow the pre-filled syringe for manual administration to come to room temperature for 30 minutes before using the syringe.

Any unused medicinal product or waste material should be disposed of in accordance with local requirements.

7. MARKETING AUTHORISATION HOLDER

Biosimilar Collaborations Ireland Limited
Unit 35/36
Grange Parade,
Baldoyle Industrial Estate,
Dublin 13
DUBLIN
Ireland
D13 R20R

8. MARKETING AUTHORISATION NUMBER(S)

EU/1/18/1329/001
EU/1/18/1329/002

9. DATE OF FIRST AUTHORISATION/RENEWAL OF THE AUTHORISATION

Date of first authorisation: 20 November 2018
Date of latest renewal:

10. DATE OF REVISION OF THE TEXT

Detailed information on this medicinal product is available on the website of the European Medicines Agency <http://www.ema.europa.eu>.

ANNEX II

- A. MANUFACTURERS OF THE BIOLOGICAL ACTIVE SUBSTANCE AND MANUFACTURERS RESPONSIBLE FOR BATCH RELEASE**
- B. CONDITIONS OR RESTRICTIONS REGARDING SUPPLY AND USE**
- C. OTHER CONDITIONS AND REQUIREMENTS OF THE MARKETING AUTHORISATION**
- D. CONDITIONS OR RESTRICTIONS WITH REGARD TO THE SAFE AND EFFECTIVE USE OF THE MEDICINAL PRODUCT**

**A. MANUFACTURERS OF THE BIOLOGICAL ACTIVE SUBSTANCE AND
MANUFACTURERS RESPONSIBLE FOR BATCH RELEASE**

Name and address of the manufacturers of the biological active substance

Biocon Biologics Limited
Block No. M1, M2 and M6, Q1 (QC3 and QC10) and W3,
20th KM, Hosur Road,
Electronics City,
Bengaluru - 560 100,
India

Biocon Biologics Limited
Block No. B1, B2, B3, Q13 of Q1 and W20 &
Unit S18, 1st Floor, Block B4
Special Economic Zone
Plot No: 2, 3, 4 & 5, Phase – IV
Bommasandra-Jigani Link Road,
Bommasandra Post,
Bengaluru – 560 099,
India

Name and address of the manufacturers responsible for batch release

Biosimilar Collaborations Ireland Limited
Block B, The Crescent Building, Santry Demesne
Dublin
D09 C6X8
Ireland

The printed package leaflet of the medicinal product must state the name and address of the manufacturer responsible for the release of the concerned batch.

B. CONDITIONS OR RESTRICTIONS REGARDING SUPPLY AND USE

Medicinal product subject to restricted medical prescription (see Annex I: Summary of Product Characteristics, section 4.2).

**C. OTHER CONDITIONS AND REQUIREMENTS OF THE MARKETING
AUTHORISATION**

• **Periodic safety update reports (PSURs)**

The requirements for submission of PSURs for this medicinal product are set out in the list of Union reference dates (EURD list) provided for under Article 107c(7) of Directive 2001/83/EC and any subsequent updates published on the European medicines web-portal.

**D. CONDITIONS OR RESTRICTIONS WITH REGARD TO THE SAFE AND
EFFECTIVE USE OF THE MEDICINAL PRODUCT**

• **Risk management plan (RMP)**

The marketing authorisation holder (MAH) shall perform the required pharmacovigilance activities

and interventions detailed in the agreed RMP presented in Module 1.8.2 of the marketing authorisation and any agreed subsequent updates of the RMP.

An updated RMP should be submitted:

- At the request of the European Medicines Agency;
- Whenever the risk management system is modified, especially as the result of new information being received that may lead to a significant change to the benefit/risk profile or as the result of an important (pharmacovigilance or risk minimisation) milestone being reached.

ANNEX III
LABELLING AND PACKAGE LEAFLET

A. LABELLING

PARTICULARS TO APPEAR ON THE OUTER PACKAGING

OUTER CARTON

1. NAME OF THE MEDICINAL PRODUCT

Fulphila 6 mg solution for injection in pre-filled syringe
pegfilgrastim

2. STATEMENT OF ACTIVE SUBSTANCE(S)

Each pre-filled syringe contains 6 mg of pegfilgrastim in 0.6 mL solution for injection (10 mg/mL).

3. LIST OF EXCIPIENTS

Sodium acetate, sorbitol (E420), polysorbate 20, water for injections. See leaflet for further information.

4. PHARMACEUTICAL FORM AND CONTENTS

Solution for injection

1 single use pre-filled syringe (0.6 mL).

1 single use pre-filled syringe with automatic needle guard (0.6 mL).

5. METHOD AND ROUTE(S) OF ADMINISTRATION

Read the package leaflet before use.

Important: read the package leaflet before handling the pre-filled syringe.

For subcutaneous use.

Avoid vigorous shaking.

6. SPECIAL WARNING THAT THE MEDICINAL PRODUCT MUST BE STORED OUT OF THE SIGHT AND REACH OF CHILDREN

Keep out of the sight and reach of children.

7. OTHER SPECIAL WARNING(S), IF NECESSARY

8. EXPIRY DATE

EXP

9. SPECIAL STORAGE CONDITIONS

Store in a refrigerator.
Do not freeze.
Keep the container in the outer carton in order to protect from light.

10. SPECIAL PRECAUTIONS FOR DISPOSAL OF UNUSED MEDICINAL PRODUCTS OR WASTE MATERIALS DERIVED FROM SUCH MEDICINAL PRODUCTS, IF APPROPRIATE

11. NAME AND ADDRESS OF THE MARKETING AUTHORISATION HOLDER

Biosimilar Collaborations Ireland Limited
Unit 35/36
Grange Parade,
Baldoyle Industrial Estate,
Dublin 13
DUBLIN
Ireland
D13 R20R

12. MARKETING AUTHORISATION NUMBER(S)

EU/1/18/1329/001
EU/1/18/1329/002

13. BATCH NUMBER

Lot

14. GENERAL CLASSIFICATION FOR SUPPLY

15. INSTRUCTIONS ON USE

16. INFORMATION IN BRAILLE

Fulphila

17. UNIQUE IDENTIFIER – 2D BARCODE

2D barcode carrying the unique identifier included.

18. UNIQUE IDENTIFIER - HUMAN READABLE DATA

PC
SN
NN

MINIMUM PARTICULARS TO APPEAR ON BLISTERS OR STRIPS

BLISTER WITH SYRINGE

1. NAME OF THE MEDICINAL PRODUCT

Fulphila 6 mg solution for injection
pegfilgrastim

2. NAME OF THE MARKETING AUTHORISATION HOLDER

Biosimilar Collaborations Ireland Limited

3. EXPIRY DATE

EXP

4. BATCH NUMBER

Lot

5. OTHER

Subcutaneous use

Important: handle syringe as pictured

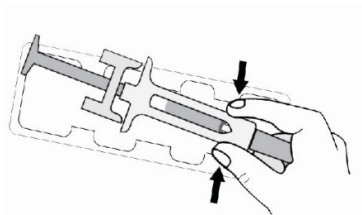

MINIMUM PARTICULARS TO APPEAR ON SMALL IMMEDIATE PACKAGING UNITS

SYRINGE LABEL

1. NAME OF THE MEDICINAL PRODUCT AND ROUTE(S) OF ADMINISTRATION

Fulphila 6 mg injection
pegfilgrastim
SC

2. METHOD OF ADMINISTRATION

3. EXPIRY DATE

EXP

4. BATCH NUMBER

Lot

5. CONTENTS BY WEIGHT, BY VOLUME OR BY UNIT

0.6 mL

6. OTHER

B. PACKAGE LEAFLET

Package leaflet: Information for the user

Fulphila 6 mg solution for injection in pre-filled syringe pegfilgrastim

Read all of this leaflet carefully before you start using this medicine because it contains important information for you.

- Keep this leaflet. You may need to read it again.
- If you have any further questions, ask your doctor, pharmacist or nurse.
- This medicine has been prescribed for you only. Do not pass it on to others. It may harm them, even if their signs of illness are the same as yours.
- If you get any side effects, talk to your doctor, pharmacist or nurse. This includes any possible side effects not listed in this leaflet. See section 4.

What is in this leaflet

1. What Fulphila is and what it is used for
2. What you need to know before you use Fulphila
3. How to use Fulphila
4. Possible side effects
5. How to store Fulphila
6. Contents of the pack and other information

1. What Fulphila is and what it is used for

Fulphila contains the active substance pegfilgrastim. Pegfilgrastim is a protein produced by biotechnology in bacteria called *E. coli*. It belongs to a group of proteins called cytokines, and is very similar to a natural protein (granulocyte-colony stimulating factor) produced by your own body.

Fulphila is used to reduce the duration of neutropenia (low white blood cell count) and the occurrence of febrile neutropenia (low white blood cell count with a fever) which can be caused by the use of cytotoxic chemotherapy (medicines that destroy rapidly growing cells). White blood cells are important as they help your body fight infection. These cells are very sensitive to the effects of chemotherapy which can cause the number of these cells in your body to decrease. If white blood cells fall to a low level there may not be enough left in the body to fight bacteria and you may have an increased risk of infection.

Your doctor has given you Fulphila to encourage your bone marrow (part of the bone which makes blood cells) to produce more white blood cells that help your body fight infection.

Fulphila is for use in adults aged 18 and over.

2. What you need to know before you use Fulphila

Do not use Fulphila

- if you are allergic to pegfilgrastim, filgrastim or any of the other ingredients of this medicine (listed in section 6).

Warnings and precautions

Talk to your doctor, pharmacist or nurse before using Fulphila:

- if you experience an allergic reaction including weakness, drop in blood pressure, difficulty breathing, swelling of the face (anaphylaxis), redness and flushing, skin rash and areas of the skin that itch.
- if you experience a cough, fever and difficulty breathing. This can be a sign of Acute Respiratory Distress Syndrome (ARDS).
- if you have any of the following or combination of the following side effects:
 - swelling or puffiness, which may be associated with passing water less frequently, difficulty breathing, abdominal swelling and feeling of fullness, and a general feeling of tiredness.

These could be symptoms of condition called “Capillary Leak Syndrome” which causes blood to leak from the small blood vessels into your body. See section 4.

- if you get left upper abdominal pain or pain at the tip of your shoulder. This may be a sign of a problem with your spleen (splenomegaly).
- if you have recently had a serious lung infection (pneumonia), fluid in the lungs (pulmonary oedema), inflammation of the lungs (interstitial lung disease) or an abnormal chest x-ray (lung infiltration).
- if you are aware of any altered blood cell counts (e.g. increase in white blood cells or anaemia) or decreased blood platelet counts, which reduces the ability of your blood to clot (thrombocytopenia). Your doctor may want to monitor you more closely.
- if you have sickle cell anaemia. Your doctor may monitor your condition more closely.
- if you are a patient with breast cancer or lung cancer, Fulphila in combination with chemotherapy and/or radiation therapy may increase your risk of a precancerous blood condition called myelodysplastic syndrome (MDS) or a blood cancer called acute myeloid leukaemia (AML). Symptoms may include tiredness, fever, and easy bruising or bleeding.
- if you have sudden signs of allergy such as rash, itching or hives on the skin, swelling of the face, lips, tongue or other parts of the body, shortness of breath, wheezing or trouble breathing, these could be signs of a severe allergic reaction.
- if you have symptoms of inflammation of the aorta (the large blood vessel which transports blood from the heart to the body); this has been reported rarely in cancer patients and healthy donors. The symptoms can include fever, abdominal pain, malaise, back pain and increased inflammatory markers. Tell your doctor if you experience these symptoms.

Your doctor will check your blood and urine regularly as Fulphila can harm the tiny filters inside your kidneys (glomerulonephritis).

Severe skin reactions (Stevens-Johnson syndrome) have been reported with the use of pegfilgrastim. Stop using Fulphila and seek medical attention immediately if you notice any of the symptoms described in section 4.

You should talk to your doctor about your risks of developing cancers of the blood. If you develop or are likely to develop cancers of the blood, you should not use Fulphila, unless instructed by your doctor.

Loss of response to Fulphila

If you experience a loss of response or failure to maintain a response with pegfilgrastim treatment, your doctor will investigate the reasons why including whether you have developed antibodies which neutralise pegfilgrastim’s activity.

Children and adolescents

Fulphila is not recommended for use in children and adolescents due to insufficient data on safety and effectiveness.

Other medicines and Fulphila

Tell your doctor or pharmacist if you are taking, have recently taken or might take any other medicines.

Pregnancy and breast-feeding

If you are pregnant or breast-feeding, think you may be pregnant or are planning to have a baby, ask your doctor or pharmacist for advice before taking this medicine.

Fulphila has not been tested in pregnant women. Therefore, your doctor may decide that you should not use this medicine.

If you become pregnant during Fulphila treatment, please inform your doctor.

Unless your doctor directs you otherwise, you must stop breast-feeding if you use Fulphila.

Driving and using machines

Fulphila has no or negligible effect on the ability to drive or use machines.

Fulphila contains sorbitol and sodium

This medicine contains 30 mg sorbitol in each pre-filled syringe which is equivalent to 50 mg/mL.

This medicine contains less than 1 mmol sodium (23 mg) per 6 mg dose, that is to say essentially 'sodium-free'.

3. How to use Fulphila

Always use this medicine exactly as your doctor has told you. Check with your doctor or pharmacist if you are not sure.

The recommended dose is one 6 mg subcutaneous injection (injection under your skin) using a pre-filled syringe and it should be given at least 24 hours after your last dose of chemotherapy at the end of each chemotherapy cycle.

Injecting Fulphila yourself

Your doctor may decide that it would be more convenient for you to inject Fulphila yourself. Your doctor or nurse will show you how to inject yourself. Do not try to inject yourself if you have not been trained.

For further instructions on how to inject yourself with Fulphila, please read the attached instructions for use.

Do not shake Fulphila vigorously as this may affect its activity.

If you use more Fulphila than you should

If you use more Fulphila than you should, contact your doctor, pharmacist or nurse.

If you forget to inject Fulphila

If you have forgotten a dose of Fulphila, you should contact your doctor to discuss when you should inject the next dose.

If you have any further questions on the use of this medicine, ask your doctor, pharmacist or nurse.

4. Possible side effects

Like all medicines, this medicine can cause side effects, although not everybody gets them.

Please tell your doctor immediately if you have any of the following or combination of the following side effects:

- swelling or puffiness, which may be associated with passing water less frequently, difficulty breathing, abdominal swelling and feeling of fullness, and a general feeling of tiredness. These symptoms generally develop in a rapid fashion.

These could be symptoms of an uncommon (may affect up to 1 in 100 people) condition called “Capillary Leak Syndrome” which causes blood to leak from the small blood vessels into your body and needs urgent medical attention.

Very common side effects (may affect more than 1 in 10 people)

- bone pain. Your doctor will tell you what you can take to ease the bone pain.
- nausea and headaches.

Common side effects (may affect up to 1 in 10 people)

- pain at the site of injection.
- general aches and pains in the joints and muscles.
- some changes may occur in your blood, but these will be detected by routine blood tests. Your white blood cell count may become high for a short period of time. Your platelet count may become low which might result in bruising.
- chest pain.

Uncommon side effects (may affect up to 1 in 100 people)

- allergic-type reactions, including redness and flushing, skin rash, and raised areas of the skin that itch.
- serious allergic reactions, including anaphylaxis (weakness, drop in blood pressure, difficulty breathing, swelling of the face).
- sickle cell crises in patients with sickle cell anaemia.
- increased spleen size.
- spleen rupture. Some cases of splenic rupture were fatal. It is important that you contact your doctor immediately if you experience pain in the upper left side of the abdomen or left shoulder pain since this may relate to a problem with your spleen.
- breathing problems. If you have a cough, fever and difficulty breathing please tell your doctor.
- Sweet’s syndrome (plum-coloured, raised, painful lesions on the limbs and sometimes the face and neck with fever) has occurred but other factors may play a role.
- cutaneous vasculitis (inflammation of the blood vessels in the skin).
- damage to the tiny filters inside your kidneys (glomerulonephritis).
- redness at the site of injection.
- coughing up blood (haemoptysis).
- Blood disorders (MDS or AML).

Rare side effects (may affect up to 1 in 1 000 people)

- inflammation of the aorta (the large blood vessel which transports blood from the heart to the body), see section 2.
- bleeding from the lung (pulmonary haemorrhage).
- Stevens-Johnson syndrome, which can appear as reddish target-like or circular patches often with central blisters on the trunk, skin peeling, ulcers of mouth, throat, nose, genitals and eyes and can be preceded by fever and flu-like symptoms. Stop using Fulphila if you develop these symptoms and contact your doctor or seek medical attention immediately. See also section 2.

Reporting of side effects

If you get any side effects, talk to your doctor, pharmacist or nurse. This includes any possible side effects not listed in this leaflet. You can also report side effects directly via the national reporting system listed in Appendix V. By reporting side effects you can help provide more information on the safety of this medicine.

5. How to store Fulphila

Keep this medicine out of the sight and reach of children.

Do not use this medicine after the expiry date which is stated on the carton, on the blister and on the syringe label after EXP. The expiry date refers to the last day of that month.

Store in a refrigerator (2 °C – 8 °C).

Do not freeze. Fulphila may be used if it is accidentally frozen for a single period of less than 24 hours.

Keep the container in the outer carton in order to protect from light.

You may take Fulphila out of the refrigerator and keep it at room temperature (not above 30 °C) for no longer than 3 days. Once a syringe has been removed from the refrigerator and has reached room temperature (not above 30 °C) it must either be used within 3 days or disposed of.

Do not use this medicine if you notice it is cloudy or there are particles in it.

Do not throw away any medicines via wastewater or household waste. Ask your pharmacist how to throw away medicines you no longer use. These measures will help protect the environment.

6. Contents of the pack and other information

What Fulphila contains

- The active substance is pegfilgrastim. Each pre-filled syringe contains 6 mg of pegfilgrastim in 0.6 mL of solution.
- The other ingredients are sodium acetate, sorbitol (E420), polysorbate 20 and water for injections. See section 2 “Fulphila contains sorbitol and sodium”.

What Fulphila looks like and contents of the pack

Fulphila is a clear, colourless solution for injection (injection) in a glass pre-filled syringe with an attached stainless steel needle and needle cap. The syringe is provided with a blister wrapping. Each pack contains 1 pre-filled syringe.

Marketing Authorisation Holder

Biosimilar Collaborations Ireland Limited
Unit 35/36
Grange Parade,
Baldoyle Industrial Estate,
Dublin 13
DUBLIN
Ireland
D13 R20R

Manufacturer

Biosimilar Collaborations Ireland Limited
Block B, The Crescent Building, Santry Demesne
Dublin
D09 C6X8
Ireland

For any information about this medicine, please contact the local representative of the Marketing Authorisation Holder:

België/Belgique/Belgien

Biocon Biologics Belgium BV
Tél/Tel: 0080008250910

България

Biosimilar Collaborations Ireland Limited
Тел.: 0080008250910

Česká republika

Biocon Biologics Germany GmbH
Tel: 0080008250910

Danmark

Biocon Biologics Finland OY
Tlf: 0080008250910

Deutschland

Biocon Biologics Germany GmbH
Tel: 0080008250910

Eesti

Biosimilar Collaborations Ireland Limited
Tel: 0080008250910

Ελλάδα

Biocon Biologics Greece ΜΟΝΟΠΡΟΣΩΠΗ
I.K.E
Τηλ: 0080008250910

España

Biocon Biologics Spain S.L.
Tel: 0080008250910

France

Biocon Biologics France S.A.S
Tél: +Téel: 0080008250910

Hrvatska

Biocon Biologics Germany GmbH
Tel: 0080008250910

Ireland

Biosimilar Collaborations Ireland Limited
Tel: 1800 777 794

Ísland

Biocon Biologics Finland OY
Sími: +345 8004316

Italia

Biocon Biologics Spain S.L.
Tel: 0080008250910

Lietuva

Biosimilar Collaborations Ireland Limited
Tel: 0080008250910

Luxembourg/Luxemburg

Biocon Biologics France S.A.S
Tél/Tel: 0080008250910

Magyarország

Biosimilar Collaborations Ireland Limited
Tel: 0080008250910

Malta

Biosimilar Collaborations Ireland Limited
Tel: 0080008250910

Nederland

Biocon Biologics France S.A.S.
Tel: 0080008250910

Norge

Biocon Biologics Finland OY
Tlf: +47 800 62 671

Österreich

Biocon Biologics Germany GmbH
Tel: 0080008250910

Polska

Biosimilar Collaborations Ireland Limited
Tel.: 0080008250910

Portugal

Biocon Biologics Spain S.L..
Tel: 0080008250910

România

Biosimilar Collaborations Ireland Limited
Tel: 0080008250910

Slovenija

Biosimilar Collaborations Ireland Limited
Tel: 0080008250910

Slovenská republika

Biocon Biologics Germany GmbH
Tel: 0080008250910

Suomi/Finland

Biocon Biologics Finland OY
Puh/Tel: 99980008250910

Κύπρος

Biosimilar Collaborations Ireland Limited
Τηλ: 0080008250910

Sverige

Biocon Biologics Finland OY
Tel: 0080008250910

Latvija

Biosimilar Collaborations Ireland Limited
Tel: 0080008250910

This leaflet was last revised in {MM/YYYY}.

Other sources of information

Detailed information on this medicine is available on the European Medicines Agency web site:

<http://www.ema.europa.eu>

Instructions for injecting with the Fulphila pre-filled syringe

This section contains information on how to give yourself an injection of Fulphila. It is important that you do not try to give yourself the injection unless you have received training from your doctor, nurse or pharmacist. If you have questions about how to inject, please ask your doctor, nurse or pharmacist for assistance.

How do you, or the person injecting you, use Fulphila pre-filled syringe?

You will need to give yourself the injection into the tissue just under the skin. This is known as a subcutaneous injection.

Equipment that you need

To give yourself a subcutaneous injection you will need:

- a pre-filled syringe of Fulphila; and
- alcohol wipes or similar.

What should I do before I give myself a subcutaneous injection of Fulphila?

1. Remove the syringe from the refrigerator.
2. Do not shake the pre-filled syringe.
3. Do not remove the needle cap from the syringe until you are ready to inject.
4. Check the expiry date on the pre-filled syringe label (EXP). Do not use it if the date has passed the last day of the month shown.
5. Check the appearance of Fulphila. It must be a clear and colourless liquid. If there are particles in it, you must not use it.
6. For a more comfortable injection, let the pre-filled syringe stand for 30 minutes to reach room temperature or hold the pre-filled syringe gently in your hand for a few minutes. Do not warm the syringe in any other way (for example, do not warm it in a microwave or in hot water).
7. Wash your hands thoroughly.
8. Find a comfortable, well-lit, clean surface and put all the equipment you need within reach.

How do I prepare my Fulphila injection?

Before you inject Fulphila you must do the following:

1. Hold the syringe barrel and gently take the cap from the needle without twisting. Pull straight as shown in pictures 1 and 2. Do not touch the needle or push the plunger.

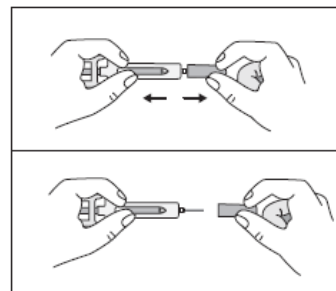

2. You may notice a small air bubble in the pre-filled syringe. You do not have to remove the air bubble before injecting. Injecting the solution with the air bubble is harmless.
3. You can now use the pre-filled syringe.

Where should I give my injection?

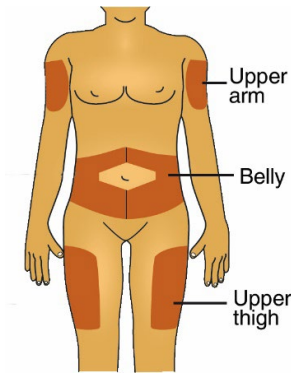

The most suitable places to inject yourself are:

- the top of your thighs; and
- the abdomen, except for the area around the navel.

If someone else is injecting you, they can also use the back of your arms.

How do I give my injection?

1. Clean your skin by using an alcohol wipe.
2. Pinch (without squeezing) the skin using your thumb and forefinger. Insert the needle into the skin.
3. Push the plunger down with a slow constant pressure. Push the plunger all the way down as far as it will go to inject all the liquid.
4. After injecting the liquid, remove the needle and let go of your skin.
5. If you notice a spot of blood at the injection site, dab with a cotton ball or tissues. Do not rub the injection site. If needed, you may cover the injection site with a plaster.
6. Do not use any Fulphila that is left in the syringe.

Remember

Only use each syringe for one injection. If you have any problems, please ask your doctor or nurse for help and advice.

Disposing of used syringes

- Do not put the cap back on used needles.
- Keep used syringes out of the sight and reach of children.
- The used syringe should be disposed of in accordance with local requirements. Ask your pharmacist how to dispose of medicines no longer required. These measures will help to protect the environment.

Package leaflet: Information for the user

Fulphila 6 mg solution for injection in pre-filled syringe pegfilgrastim

Read all of this leaflet carefully before you start using this medicine because it contains important information for you.

- Keep this leaflet. You may need to read it again.
- If you have any further questions, ask your doctor, pharmacist or nurse.
- This medicine has been prescribed for you only. Do not pass it on to others. It may harm them, even if their signs of illness are the same as yours.
- If you get any side effects, talk to your doctor, pharmacist or nurse. This includes any possible side effects not listed in this leaflet. See section 4.

What is in this leaflet

1. What Fulphila is and what it is used for
2. What you need to know before you use Fulphila
3. How to use Fulphila
4. Possible side effects
5. How to store Fulphila
6. Contents of the pack and other information

1. What Fulphila is and what it is used for

Fulphila contains the active substance pegfilgrastim. Pegfilgrastim is a protein produced by biotechnology in bacteria called *E. coli*. It belongs to a group of proteins called cytokines, and is very similar to a natural protein (granulocyte-colony stimulating factor) produced by your own body.

Fulphila is used to reduce the duration of neutropenia (low white blood cell count) and the occurrence of febrile neutropenia (low white blood cell count with a fever) which can be caused by the use of cytotoxic chemotherapy (medicines that destroy rapidly growing cells). White blood cells are important as they help your body fight infection. These cells are very sensitive to the effects of chemotherapy which can cause the number of these cells in your body to decrease. If white blood cells fall to a low level there may not be enough left in the body to fight bacteria and you may have an increased risk of infection.

Your doctor has given you Fulphila to encourage your bone marrow (part of the bone which makes blood cells) to produce more white blood cells that help your body fight infection.

Fulphila is for use in adults aged 18 and over.

2. What you need to know before you use Fulphila

Do not use Fulphila

- if you are allergic to pegfilgrastim, filgrastim or any of the other ingredients of this medicine (listed in section 6).

Warnings and precautions

Talk to your doctor, pharmacist or nurse before using Fulphila:

- if you experience an allergic reaction including weakness, drop in blood pressure, difficulty breathing, swelling of the face (anaphylaxis), redness and flushing, skin rash and areas of the skin that itch.
- if you experience a cough, fever and difficulty breathing. This can be a sign of Acute Respiratory Distress Syndrome (ARDS).
- if you have any of the following or combination of the following side effects:
 - swelling or puffiness, which may be associated with passing water less frequently, difficulty breathing, abdominal swelling and feeling of fullness, and a general feeling of tiredness.

These could be symptoms of condition called “Capillary Leak Syndrome” which causes blood to leak from the small blood vessels into your body. See section 4.

- if you get left upper abdominal pain or pain at the tip of your shoulder. This may be a sign of a problem with your spleen (splenomegaly).
- if you have recently had a serious lung infection (pneumonia), fluid in the lungs (pulmonary oedema), inflammation of the lungs (interstitial lung disease) or an abnormal chest x-ray (lung infiltration).
- if you are aware of any altered blood cell counts (e.g. increase in white blood cells or anaemia) or decreased blood platelet counts, which reduces the ability of your blood to clot (thrombocytopenia). Your doctor may want to monitor you more closely.
- if you have sickle cell anaemia. Your doctor may monitor your condition more closely.
- if you are a patient with breast cancer or lung cancer, Fulphila in combination with chemotherapy and/or radiation therapy may increase your risk of a precancerous blood condition called myelodysplastic syndrome (MDS) or a blood cancer called acute myeloid leukaemia (AML). Symptoms may include tiredness, fever, and easy bruising or bleeding.
- if you have sudden signs of allergy such as rash, itching or hives on the skin, swelling of the face, lips, tongue or other parts of the body, shortness of breath, wheezing or trouble breathing, these could be signs of a severe allergic reaction.
- if you have symptoms of inflammation of the aorta (the large blood vessel which transports blood from the heart to the body); this has been reported rarely in cancer patients and healthy donors. The symptoms can include fever, abdominal pain, malaise, back pain and increased inflammatory markers. Tell your doctor if you experience these symptoms.

Your doctor will check your blood and urine regularly as Fulphila can harm the tiny filters inside your kidneys (glomerulonephritis).

Severe skin reactions (Stevens-Johnson syndrome) have been reported with the use of pegfilgrastim. Stop using Fulphila and seek medical attention immediately if you notice any of the symptoms described in section 4.

You should talk to your doctor about your risks of developing cancers of the blood. If you develop or are likely to develop cancers of the blood, you should not use Fulphila, unless instructed by your doctor.

Loss of response to Fulphila

If you experience a loss of response or failure to maintain a response with pegfilgrastim treatment, your doctor will investigate the reasons why including whether you have developed antibodies which neutralise pegfilgrastim’s activity.

Children and adolescents

Fulphila is not recommended for use in children and adolescents due to insufficient data on safety and effectiveness.

Other medicines and Fulphila

Tell your doctor or pharmacist if you are taking, have recently taken or might take any other medicines.

Pregnancy and breast-feeding

If you are pregnant or breast-feeding, think you may be pregnant or are planning to have a baby, ask your doctor or pharmacist for advice before taking this medicine.

Fulphila has not been tested in pregnant women. Therefore, your doctor may decide that you should not use this medicine.

If you become pregnant during Fulphila treatment, please inform your doctor.
Unless your doctor directs you otherwise, you must stop breast-feeding if you use Fulphila.

Driving and using machines

Fulphila has no or negligible effect on the ability to drive or use machines.

Fulphila contains sorbitol and sodium

This medicine contains 30 mg sorbitol in each pre-filled syringe which is equivalent to 50 mg/mL.

This medicine contains less than 1 mmol sodium (23 mg) per 6 mg dose, that is to say essentially 'sodium-free'.

3. How to use Fulphila

Always use this medicine exactly as your doctor has told you. Check with your doctor or pharmacist if you are not sure.

The recommended dose is one 6 mg subcutaneous injection (injection under your skin) using a pre-filled syringe and it should be given at least 24 hours after your last dose of chemotherapy at the end of each chemotherapy cycle.

Injecting Fulphila yourself

Your doctor may decide that it would be more convenient for you to inject Fulphila yourself. Your doctor or nurse will show you how to inject yourself. Do not try to inject yourself if you have not been trained.

For further instructions on how to inject yourself with pegfilgrastim, please read the attached instructions for use.

Do not shake Fulphila vigorously as this may affect its activity.

If you use more Fulphila than you should

If you use more Fulphila than you should contact your doctor, pharmacist or nurse.

If you forget to inject Fulphila

If you have forgotten a dose of Fulphila, you should contact your doctor to discuss when you should inject the next dose.

If you have any further questions on the use of this medicine, ask your doctor, pharmacist or nurse.

4. Possible side effects

Like all medicines, this medicine can cause side effects, although not everybody gets them.

Please tell your doctor immediately if you have any of the following or combination of the following side effects:

- swelling or puffiness, which may be associated with passing water less frequently, difficulty breathing, abdominal swelling and feeling of fullness, and a general feeling of tiredness. These symptoms generally develop in a rapid fashion.

These could be symptoms of an uncommon (may affect up to 1 in 100 people) condition called “Capillary Leak Syndrome” which causes blood to leak from the small blood vessels into your body and needs urgent medical attention.

Very common side effects (may affect more than 1 in 10 people)

- bone pain. Your doctor will tell you what you can take to ease the bone pain.
- nausea and headaches.

Common side effects (may affect up to 1 in 10 people)

- pain at the site of injection.
- general aches and pains in the joints and muscles.
- some changes may occur in your blood, but these will be detected by routine blood tests. Your white blood cell count may become high for a short period of time. Your platelet count may become low which might result in bruising.
- chest pain.

Uncommon side effects (may affect up to 1 in 100 people)

- allergic-type reactions, including redness and flushing, skin rash, and raised areas of the skin that itch.
- serious allergic reactions, including anaphylaxis (weakness, drop in blood pressure, difficulty breathing, swelling of the face).
- sickle cell crises in patients with sickle cell anaemia.
- increased spleen size.
- spleen rupture. Some cases of splenic rupture were fatal. It is important that you contact your doctor immediately if you experience pain in the upper left side of the abdomen or left shoulder pain since this may relate to a problem with your spleen.
- breathing problems. If you have a cough, fever and difficulty breathing please tell your doctor.
- Sweet’s syndrome (plum-coloured, raised, painful lesions on the limbs and sometimes the face and neck with fever) has occurred but other factors may play a role.
- cutaneous vasculitis (inflammation of the blood vessels in the skin).
- damage to the tiny filters inside your kidneys (glomerulonephritis).
- redness at the site of injection.
- coughing up blood (haemoptysis).
- blood disorders (MDS or AML).

Rare side effects (may affect up to 1 in 1 000 people)

- inflammation of the aorta (the large blood vessel which transports blood from the heart to the body), see section 2.
- bleeding from the lung (pulmonary haemorrhage).
- Stevens-Johnson syndrome, which can appear as reddish target-like or circular patches often with central blisters on the trunk, skin peeling, ulcers of mouth, throat, nose, genitals and eyes and can be preceded by fever and flu-like symptoms. Stop using Fulphila if you develop these symptoms and contact your doctor or seek medical attention immediately. See also section 2.

Reporting of side effects

If you get any side effects, talk to your doctor, pharmacist or nurse. This includes any possible side effects not listed in this leaflet. You can also report side effects directly via the **national reporting system listed in Appendix V**. By reporting side effects you can help provide more information on the safety of this medicine.

5. How to store Fulphila

Keep this medicine out of the sight and reach of children.

Do not use this medicine after the expiry date which is stated on the carton, on the blister and on the syringe label after EXP. The expiry date refers to the last day of that month.

Store in a refrigerator (2 °C – 8 °C).

Do not freeze. Fulphila may be used if it is accidentally frozen for a single period of less than 24 hours.

Keep the container in the outer carton in order to protect from light.

You may take Fulphila out of the refrigerator and keep it at room temperature (not above 30 °C) for no longer than 3 days. Once a syringe has been removed from the refrigerator and has reached room temperature (not above 30 °C) it must either be used within 3 days or disposed of.

Do not use this medicine if you notice it is cloudy or there are particles in it.

Do not throw away any medicines via wastewater or household waste. Ask your pharmacist how to throw away medicines you no longer use. These measures will help protect the environment.

6. Contents of the pack and other information

What Fulphila contains

- The active substance is pegfilgrastim. Each pre-filled syringe contains 6 mg of pegfilgrastim in 0.6 mL of solution.
- The other ingredients are sodium acetate, sorbitol (E420), polysorbate 20 and water for injections. See section 2 “Fulphila contains sorbitol and sodium”.

What Fulphila looks like and contents of the pack

Fulphila is a clear, colourless solution for injection (injection) in a glass pre-filled syringe with an attached stainless steel needle and needle cap. The syringe is provided with a blister wrapping, the syringe is provided with an automatic needle guard.

Each pack contains 1 glass pre-filled syringe

Marketing Authorisation Holder

Biosimilar Collaborations Ireland Limited
Unit 35/36
Grange Parade,
Baldoyle Industrial Estate,
Dublin 13
DUBLIN
Ireland
D13 R20R

Manufacturer

Biosimilar Collaborations Ireland Limited
Block B, The Crescent Building, Santry Demesne
Dublin
D09 C6X8
Ireland

For any information about this medicine, please contact the local representative of the Marketing Authorisation Holder:

België/Belgique/Belgien

Biocon Biologics Belgium BV
Tél/Tel: 0080008250910

България

Biosimilar Collaborations Ireland Limited
Тел.: 0080008250910

Česká republika

Biocon Biologics Germany GmbH
Tel: 0080008250910

Danmark

Biocon Biologics Finland OY
Tlf: 0080008250910

Deutschland

Biocon Biologics Germany GmbH
Tel: 0080008250910

Eesti

Biosimilar Collaborations Ireland Limited
Tel: 0080008250910

Ελλάδα

Biocon Biologics Greece ΜΟΝΟΠΡΟΣΩΠΗ
I.K.E
Τηλ: 0080008250910

España

Biocon Biologics Spain S.L.
Tel: 0080008250910

France

Biocon Biologics France S.A.S
Tél: +Teél: 0080008250910

Hrvatska

Biocon Biologics Germany GmbH
Tel: 0080008250910

Ireland

Biosimilar Collaborations Ireland Limited
Tel: 1800 777 794

Ísland

Biocon Biologics Finland OY
Sími: +345 8004316

Lietuva

Biosimilar Collaborations Ireland Limited
Tel: 0080008250910

Luxembourg/Luxemburg

Biocon Biologics France S.A.S
Tél/Tel: 0080008250910

Magyarország

Biosimilar Collaborations Ireland Limited
Tel: 0080008250910

Malta

Biosimilar Collaborations Ireland Limited
Tel: 0080008250910

Nederland

Biocon Biologics France S.A.S.
Tel: 0080008250910

Norge

Biocon Biologics Finland OY
Tlf: +47 800 62 671

Österreich

Biocon Biologics Germany GmbH
Tel: 0080008250910

Polska

Biosimilar Collaborations Ireland Limited
Tel.: 0080008250910

Portugal

Biocon Biologics Spain S.L..
Tel: 0080008250910

România

Biosimilar Collaborations Ireland Limited
Tel: 0080008250910

Slovenija

Biosimilar Collaborations Ireland Limited
Tel: 0080008250910

Slovenská republika

Biocon Biologics Germany GmbH
Tel: 0080008250910

Italia

Biocon Biologics Spain S.L.
Tel: 0080008250910

Suomi/Finland

Biocon Biologics Finland OY
Puh/Tel: 99980008250910

Κύπρος

Biosimilar Collaborations Ireland Limited
Τηλ: 0080008250910

Sverige

Biocon Biologics Finland OY
Tel: 0080008250910

Latvija

Biosimilar Collaborations Ireland Limited
Tel: 0080008250910

This leaflet was last revised in {MM/YYYY}.

Other sources of information

Detailed information on this medicine is available on the European Medicines Agency web site:
<http://www.ema.europa.eu>

Instructions for use:

Guide to parts

Before use

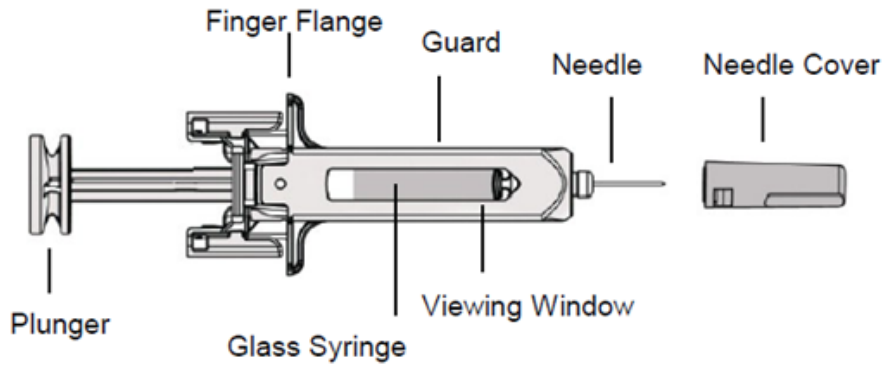

After use

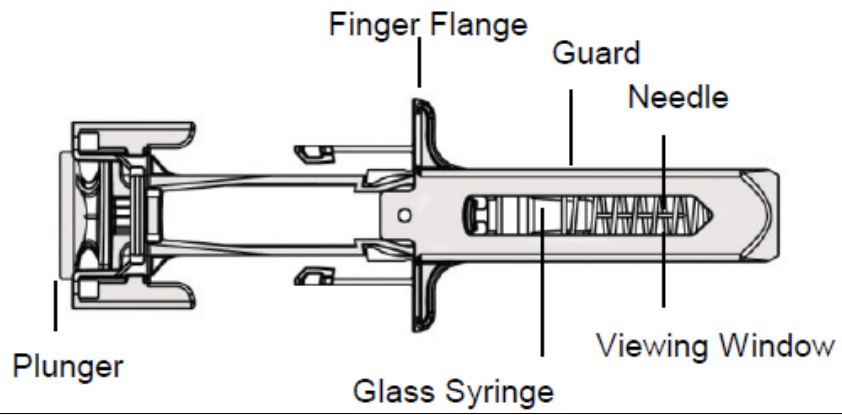

Important

Before you use a Fulphila pre-filled syringe with automatic needle guard, read this important information:

- It is important that you do not try to give yourself the injection unless you have received training from your doctor or healthcare provider.
 - Fulphila is given as an injection into the tissue just under the skin (subcutaneous injection).
- X** Do not remove the grey needle cap from the pre-filled syringe until you are ready to inject.
- X** Do not use the pre-filled syringe if it has been dropped on a hard surface. Use a new pre-filled syringe and call your doctor or healthcare provider.
- X** Do not attempt to activate the pre-filled syringe prior to injection.
- X** Do not attempt to remove the clear pre-filled syringe safety guard from the pre-filled syringe.

Call your doctor or healthcare provider if you have any questions.

Step 1: Prepare

- A. Remove the pre-filled syringe tray from the package and gather the supplies needed for your injection: alcohol wipes, a cotton ball or gauze pad, a plaster and a sharps disposal container (not included).

For a more comfortable injection, leave the pre-filled syringe at room temperature for about 30 minutes before injecting. Wash your hands thoroughly with soap and water.

On a clean, well-lit work surface, place the new pre-filled syringe and the other supplies.

- X** Do not try to warm the syringe by using a heat source such as hot water or microwave.
- X** Do not leave the pre-filled syringe exposed to direct sunlight.
- X** Do not shake the pre-filled syringe.
- Keep pre-filled syringes out of the sight and reach of children.

- B. Open the tray, peeling away the cover. Grab the pre-filled syringe safety guard to remove the pre-filled syringe from the tray.

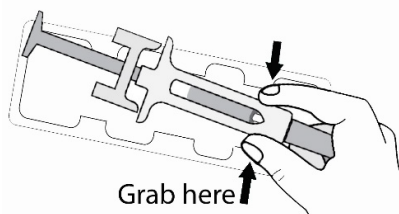

For safety reasons:

- X** Do not grasp the plunger.
- X** Do not grasp the grey needle cap.

- C. Inspect the medicine and pre-filled syringe.

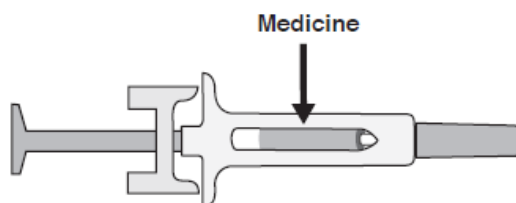

- X** Do not use the pre-filled syringe if:

- The medicine is cloudy or there are particles in it. It must be a clear and colourless liquid.
- Any part appears cracked or broken.
- The grey needle cap is missing or not securely attached.
- The expiry date printed on the label has passed the last day of the month shown.

In all cases, call your doctor or healthcare provider.

Step 2: Get ready

A. Wash your hands thoroughly. Prepare and clean your injection site.

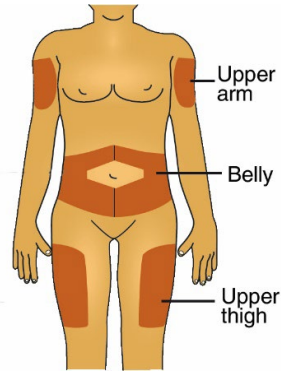

You can use:

- Upper part of your thigh
- Belly, except for a 5 cm (2-inch) area right around your belly button.
- Outer area of upper arm (only if someone else is giving you the injection).

Clean the injection site with an alcohol wipe. Let your skin dry.

X Do not touch the injection site before injecting.



Do not inject into areas where the skin is tender, bruised, red, or hard. Avoid injecting into areas with scars or stretch marks.

B Carefully pull the grey needle cap straight out and away from your body.

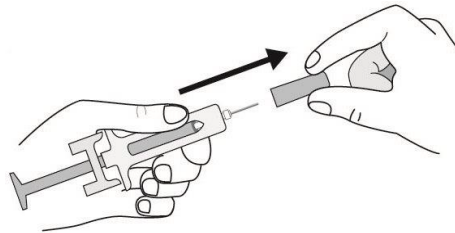

C Pinch your injection site to create a firm surface.

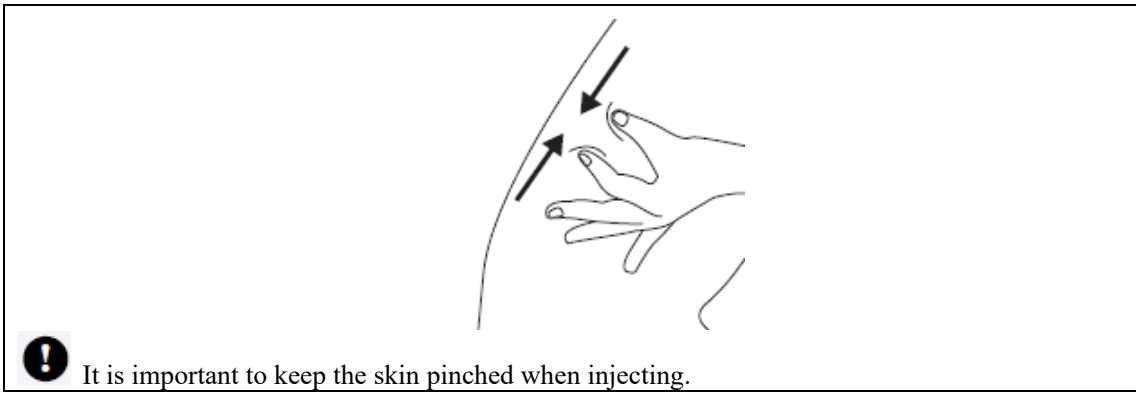

Step 3: Inject

A Hold the pinch. INSERT the needle into skin.

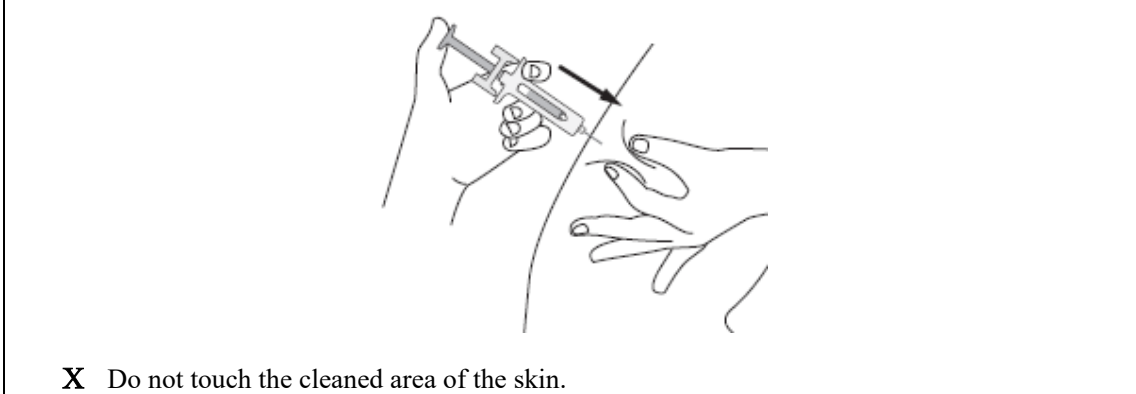

B PUSH the plunger with slow and constant pressure until you feel or hear a “snap”. Push all the way down through the snap.

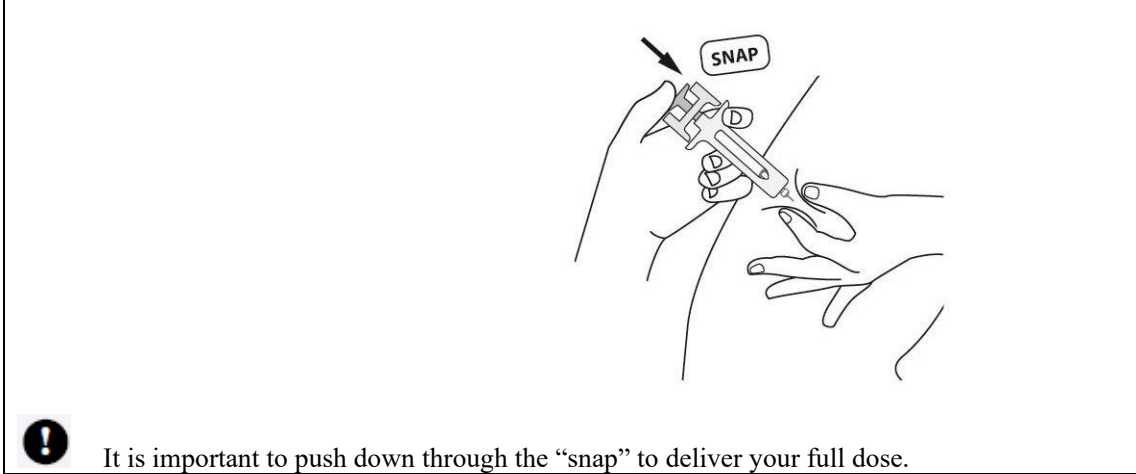

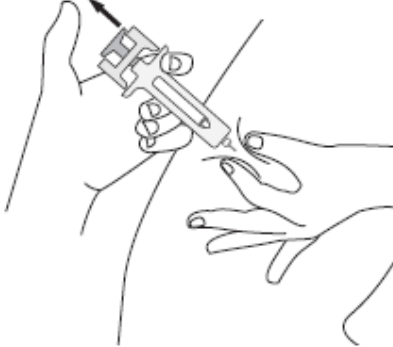
C	RELEASE your thumb. Then LIFT the syringe off skin.
	
<p>After releasing the plunger, the pre-filled syringe safety guard will safely cover the injection needle.</p> <p>X Do not put the grey needle cap back on used pre-filled syringes.</p>	

<p>Healthcare professionals only</p> <p>The trade name of the administered product should be clearly recorded in the patient file.</p>

Step 4: Finish	
A	Discard the used pre-filled syringe and other supplies in a sharps disposal container.
	
<p>Medicines should be disposed of in accordance with local requirements. Ask your pharmacist how to dispose of medicines no longer required. These measures will help to protect the environment.</p> <p>Keep the syringe and sharps disposal container out of sight and reach of children.</p> <p>X Do not reuse the pre-filled syringe.</p> <p>X Do not recycle pre-filled syringes or throw them into household waste.</p>	

B	Examine the injection site.
<p>If there is blood, press a cotton ball or gauze pad on your injection site. Do not rub the injection site. Apply a plaster if needed.</p>	