

ANNEX I
SUMMARY OF PRODUCT CHARACTERISTICS

1. NAME OF THE MEDICINAL PRODUCT

Hyrimoz 20 mg solution for injection in pre-filled syringe

Hyrimoz 40 mg solution for injection in pre-filled syringe

Hyrimoz 40 mg solution for injection in pre-filled pen

2. QUALITATIVE AND QUANTITATIVE COMPOSITION

Hyrimoz 20 mg solution for injection in pre-filled syringe

Each 0.4 ml single-dose pre-filled syringe contains 20 mg of adalimumab.

Hyrimoz 40 mg solution for injection in pre-filled syringe

Each 0.8 ml single-dose pre-filled syringe contains 40 mg of adalimumab.

Hyrimoz 40 mg solution for injection in pre-filled pen

Each 0.8 ml single-dose pre-filled pen contains 40 mg of adalimumab.

Adalimumab is a recombinant human monoclonal antibody produced in Chinese Hamster Ovary cells.

For the full list of excipients, see section 6.1.

3. PHARMACEUTICAL FORM

Solution for injection (injection) in pre-filled syringe

Solution for injection (injection) in pre-filled pen (SensoReady)

Clear to slightly opalescent, colourless or slightly yellowish solution.

4. CLINICAL PARTICULARS

4.1 Therapeutic indications

Rheumatoid arthritis

Hyrimoz in combination with methotrexate, is indicated for:

- the treatment of moderate to severe, active rheumatoid arthritis in adult patients when the response to disease-modifying anti-rheumatic drugs including methotrexate has been inadequate.
- the treatment of severe, active and progressive rheumatoid arthritis in adults not previously treated with methotrexate.

Hyrimoz can be given as monotherapy in case of intolerance to methotrexate or when continued treatment with methotrexate is inappropriate.

Adalimumab has been shown to reduce the rate of progression of joint damage as measured by X-ray and to improve physical function, when given in combination with methotrexate.

Juvenile idiopathic arthritis

Polyarticular juvenile idiopathic arthritis

Hyrimoz in combination with methotrexate is indicated for the treatment of active polyarticular juvenile idiopathic arthritis, in patients from the age of 2 years who have had an inadequate response to one or more disease-modifying anti-rheumatic drugs (DMARDs). Hyrimoz can be given as monotherapy in case of intolerance to methotrexate or when continued treatment with methotrexate is inappropriate (for the efficacy in monotherapy, see section 5.1). Adalimumab has not been studied in patients aged less than 2 years.

Enthesitis-related arthritis

Hyrimoz is indicated for the treatment of active enthesitis-related arthritis in patients, 6 years of age and older, who have had an inadequate response to, or who are intolerant of, conventional therapy (see section 5.1).

Axial spondyloarthritis

Ankylosing spondylitis (AS)

Hyrimoz is indicated for the treatment of adults with severe active ankylosing spondylitis who have had an inadequate response to conventional therapy.

Axial spondyloarthritis without radiographic evidence of AS

Hyrimoz is indicated for the treatment of adults with severe axial spondyloarthritis without radiographic evidence of AS but with objective signs of inflammation by elevated CRP and/or MRI, who have had an inadequate response to, or are intolerant to non-steroidal anti-inflammatory drugs (NSAIDs).

Psoriatic arthritis

Hyrimoz is indicated for the treatment of active and progressive psoriatic arthritis in adults when the response to previous disease-modifying anti-rheumatic drug therapy has been inadequate.

Adalimumab has been shown to reduce the rate of progression of peripheral joint damage as measured by X-ray in patients with polyarticular symmetrical subtypes of the disease (see section 5.1) and to improve physical function.

Psoriasis

Hyrimoz is indicated for the treatment of moderate to severe chronic plaque psoriasis in adult patients who are candidates for systemic therapy.

Paediatric plaque psoriasis

Hyrimoz is indicated for the treatment of severe chronic plaque psoriasis in children and adolescents from 4 years of age who have had an inadequate response to or are inappropriate candidates for topical therapy and phototherapies.

Hidradenitis suppurativa (HS)

Hyrimoz is indicated for the treatment of active moderate to severe hidradenitis suppurativa (acne inversa) in adults and adolescents from 12 years of age with an inadequate response to conventional systemic HS therapy (see sections 5.1 and 5.2).

Crohn's disease

Hyrimoz is indicated for treatment of moderately to severely active Crohn's disease in adult patients who have not responded despite a full and adequate course of therapy with a corticosteroid and/or an immunosuppressant; or who are intolerant to or have medical contraindications for such therapies.

Paediatric Crohn's disease

Hyrimoz is indicated for the treatment of moderately to severely active Crohn's disease in paediatric patients (from 6 years of age) who have had an inadequate response to conventional therapy including primary nutrition therapy and a corticosteroid and/or an immunomodulator, or who are intolerant to or have contraindications for such therapies.

Ulcerative colitis

Hyrimoz is indicated for treatment of moderately to severely active ulcerative colitis in adult patients who have had an inadequate response to conventional therapy including corticosteroids and 6-mercaptopurine (6-MP) or azathioprine (AZA), or who are intolerant to or have medical contraindications for such therapies.

Paediatric ulcerative colitis

Hyrimoz is indicated for the treatment of moderately to severely active ulcerative colitis in paediatric patients (from 6 years of age) who have had an inadequate response to conventional therapy including corticosteroids and/or 6-mercaptopurine (6-MP) or azathioprine (AZA), or who are intolerant to or have medical contraindications for such therapies.

Uveitis

Hyrimoz is indicated for the treatment of non-infectious intermediate, posterior and panuveitis in adult patients who have had an inadequate response to corticosteroids, in patients in need of corticosteroid-sparing, or in whom corticosteroid treatment is inappropriate.

Paediatric uveitis

Hyrimoz is indicated for the treatment of paediatric chronic non-infectious anterior uveitis in patients from 2 years of age who have had an inadequate response to or are intolerant to conventional therapy, or in whom conventional therapy is inappropriate.

4.2 Posology and method of administration

Hyrimoz treatment should be initiated and supervised by specialist physicians experienced in the diagnosis and treatment of conditions for which Hyrimoz is indicated. Ophthalmologists are advised to consult with an appropriate specialist before initiation of treatment with Hyrimoz (see section 4.4). Patients treated with Hyrimoz should be given the Patient Reminder Card.

After proper training in injection technique, patients may self-inject with Hyrimoz if their physician determines that it is appropriate and with medical follow-up as necessary.

During treatment with Hyrimoz, other concomitant therapies (e.g., corticosteroids and/or immunomodulatory agents) should be optimised.

Posology

Rheumatoid arthritis

The recommended dose of Hyrimoz for adult patients with rheumatoid arthritis is 40 mg adalimumab administered every other week as a single dose via subcutaneous injection. Methotrexate should be continued during treatment with Hyrimoz.

Glucocorticoids, salicylates, non-steroidal anti-inflammatory drugs, or analgesics can be continued during treatment with Hyrimoz. Regarding combination with disease-modifying anti-rheumatic drugs other than methotrexate, see sections 4.4 and 5.1.

In monotherapy, some patients who experience a decrease in their response to Hyrimoz 40 mg every other week may benefit from an increase in dose to 40 mg adalimumab every week or 80 mg every other week.

Available data suggest that the clinical response is usually achieved within 12 weeks of treatment. Continued therapy should be reconsidered in a patient not responding within this time period.

Dose interruption

There may be a need for dose interruption, for instance before surgery or if a serious infection occurs.

Available data suggest that re-introduction of adalimumab after discontinuation for 70 days or longer resulted in the same magnitudes of clinical response and similar safety profile as before dose interruption.

Ankylosing spondylitis, axial spondyloarthritis without radiographic evidence of AS and psoriatic arthritis

The recommended dose of Hyrimoz for patients with ankylosing spondylitis, axial spondyloarthritis without radiographic evidence of AS and for patients with psoriatic arthritis is 40 mg adalimumab administered every other week as a single dose via subcutaneous injection.

Available data suggest that the clinical response is usually achieved within 12 weeks of treatment. Continued therapy should be reconsidered in a patient not responding within this time period.

Psoriasis

The recommended dose of Hyrimoz for adult patients is an initial dose of 80 mg administered subcutaneously, followed by 40 mg subcutaneously given every other week starting one week after the initial dose.

Continued therapy beyond 16 weeks should be carefully reconsidered in a patient not responding within this time period.

Beyond 16 weeks, patients with inadequate response to Hyrimoz 40 mg every other week may benefit from an increase in dose to 40 mg every week or 80 mg every other week. The benefits and risks of continued 40 mg weekly or 80 mg every other week therapy should be carefully reconsidered in a patient with an inadequate response after the increase in dose (see section 5.1). If adequate response is achieved with 40 mg every week or 80 mg every other week, the dose may subsequently be reduced to 40 mg every other week.

Hidradenitis suppurativa

The recommended Hyrimoz dose regimen for adult patients with hidradenitis suppurativa (HS) is 160 mg initially at Day 1 (given as four 40 mg injections in one day or as two 40 mg injections per

day for two consecutive days), followed by 80 mg two weeks later at Day 15 (given as two 40 mg injections in one day). Two weeks later (Day 29) continue with a dose of 40 mg every week or 80 mg every other week (given as two 40 mg injections in one day). Antibiotics may be continued during treatment with Hyrimoz, if necessary. It is recommended that the patient should use a topical antiseptic wash on their HS lesions on a daily basis during treatment with Hyrimoz.

Continued therapy beyond 12 weeks should be carefully reconsidered in a patient with no improvement within this time period.

Should treatment be interrupted, Hyrimoz 40 mg every week or 80 mg every other week may be re-introduced (see section 5.1).

The benefit and risk of continued long-term treatment should be periodically evaluated (see section 5.1).

Crohn's disease

The recommended Hyrimoz induction dose regimen for adult patients with moderately to severely active Crohn's disease is 80 mg at Week 0 followed by 40 mg at Week 2. In case there is a need for a more rapid response to therapy, the regimen 160 mg at Week 0 (given as four 40 mg injections in one day or as two 40 mg injections per day for two consecutive days), followed by 80 mg at Week 2 (given as two 40 mg injections in one day), can be used with the awareness that the risk for adverse events is higher during induction.

After induction treatment, the recommended dose is 40 mg every other week via subcutaneous injection. Alternatively, if a patient has stopped Hyrimoz and signs and symptoms of disease recur, Hyrimoz may be re-administered. There is little experience from re-administration after more than 8 weeks since the previous dose.

During maintenance treatment, corticosteroids may be tapered in accordance with clinical practice guidelines.

Some patients who experience decrease in their response to Hyrimoz 40 mg every other week may benefit from an increase in dose to 40 mg Hyrimoz every week or 80 mg every other week.

Some patients who have not responded by Week 4 may benefit from continued maintenance therapy through Week 12. Continued therapy should be carefully reconsidered in a patient not responding within this time period.

Ulcerative colitis

The recommended Hyrimoz induction dose regimen for adult patients with moderate to severe ulcerative colitis is 160 mg at Week 0 (given as four 40 mg injections in one day or as two 40 mg injections per day for two consecutive days) and 80 mg at Week 2 (given as two 40 mg injections in one day). After induction treatment, the recommended dose is 40 mg every other week via subcutaneous injection.

During maintenance treatment, corticosteroids may be tapered in accordance with clinical practice guidelines.

Some patients who experience decrease in their response to Hyrimoz 40 mg every other week may benefit from an increase in dose to 40 mg Hyrimoz every week or 80 mg every other week.

Available data suggest that the clinical response is usually achieved within 2–8 weeks of treatment. Hyrimoz therapy should not be continued in patients failing to respond within this time period.

Uveitis

The recommended dose of Hyrimoz for adult patients with uveitis is an initial dose of 80 mg, followed by 40 mg given every other week starting one week after the initial dose. There is limited experience in the initiation of treatment with adalimumab alone. Treatment with Hyrimoz can be initiated in combination with corticosteroids and/or with other non-biologic immunomodulatory agents. Concomitant corticosteroids may be tapered in accordance with clinical practice starting two weeks after initiating treatment with Hyrimoz.

It is recommended that the benefit and risk of continued long-term treatment should be evaluated on a yearly basis (see section 5.1).

Special populations

Elderly

No dose adjustment is required.

Renal and/or hepatic impairment

Adalimumab has not been studied in these patient populations. No dose recommendations can be made.

Paediatric population

Juvenile idiopathic arthritis

Polyarticular juvenile idiopathic arthritis from 2 years of age

The recommended dose of Hyrimoz for patients with polyarticular juvenile idiopathic arthritis from 2 years of age is based on body weight (Table 1). Hyrimoz is administered every other week via subcutaneous injection.

Table 1. Hyrimoz dose for patients with polyarticular juvenile idiopathic arthritis

Patient weight	Dosing regimen
10 kg to < 30 kg	20 mg every other week
≥ 30 kg	40 mg every other week

Available data suggest that clinical response is usually achieved within 12 weeks of treatment. Continued therapy should be carefully reconsidered in a patient not responding within this time period.

There is no relevant use of adalimumab in patients aged less than 2 years for this indication.

Enthesitis-related arthritis

The recommended dose of Hyrimoz for patients with enthesitis-related arthritis from 6 years of age is based on body weight (Table 2). Hyrimoz is administered every other week via subcutaneous injection.

Table 2. Hyrimoz dose for patients with enthesitis-related arthritis

Patient weight	Dosing regimen
15 kg to < 30 kg	20 mg every other week
≥ 30 kg	40 mg every other week

Adalimumab has not been studied in patients with enthesitis-related arthritis aged less than 6 years.

Paediatric plaque psoriasis

The recommended Hyrimoz dose for patients with plaque psoriasis from 4 to 17 years of age is based on body weight (Table 3). Hyrimoz is administered via subcutaneous injection.

Table 3. Hyrimoz dose for paediatric patients with plaque psoriasis

Patient weight	Dosing regimen
15 kg to < 30 kg	Initial dose of 20 mg, followed by 20 mg every other week starting one week after the initial dose
≥ 30 kg	Initial dose of 40 mg, followed by 40 mg given every other week starting one week after the initial dose

Continued therapy beyond 16 weeks should be carefully considered in a patient not responding within this time period.

If re-treatment with adalimumab is indicated, the above guidance on dose and treatment duration should be followed.

The safety of adalimumab in paediatric patients with plaque psoriasis has been assessed for a mean of 13 months.

There is no relevant use of adalimumab in children aged less than 4 years for this indication.

Adolescent hidradenitis suppurativa (from 12 years of age, weighing at least 30 kg)

There are no clinical studies with adalimumab in adolescent patients with HS. The posology of adalimumab in these patients has been determined from pharmacokinetic modelling and simulation (see section 5.2).

The recommended Hyrimoz dose is 80 mg at Week 0 followed by 40 mg every other week starting at Week 1 via subcutaneous injection.

In adolescent patients with inadequate response to Hyrimoz 40 mg every other week, an increase in dose to 40 mg every week or 80 mg every other week may be considered.

Antibiotics may be continued during treatment with Hyrimoz if necessary. It is recommended that the patient should use a topical antiseptic wash on their HS lesions on a daily basis during treatment with Hyrimoz.

Continued therapy beyond 12 weeks should be carefully reconsidered in a patient with no improvement within this time period.

Should treatment be interrupted, Hyrimoz may be re-introduced as appropriate.

The benefit and risk of continued long-term treatment should be periodically evaluated (see adult data in section 5.1)

There is no relevant use of adalimumab in children aged less than 12 years in this indication.

Paediatric Crohn's disease

The recommended dose of Hyrimoz for patients with Crohn's disease from 6 to 17 years of age is based on body weight (Table 4). Hyrimoz is administered via subcutaneous injection.

Table 4. Hyrimoz dose for paediatric patients with Crohn's disease

Patient weight	Induction dose	Maintenance dose starting at Week 4
< 40 kg	<ul style="list-style-type: none">• 40 mg at Week 0 and 20 mg at Week 2 <p>In case there is a need for a more rapid response to therapy with the awareness that the risk for adverse events may be higher with use of the higher induction dose, the following dose may be used:</p> <ul style="list-style-type: none">• 80 mg at Week 0 and 40 mg at Week 2	20 mg every other week
≥ 40 kg	<ul style="list-style-type: none">• 80 mg at Week 0 and 40 mg at Week 2 <p>In case there is a need for a more rapid response to therapy with the awareness that the risk for adverse events may be higher with use of the higher induction dose, the following dose may be used:</p> <ul style="list-style-type: none">• 160 mg at Week 0 and 80 mg at Week 2	40 mg every other week

Patients who experience insufficient response may benefit from an increase in dose.

- < 40 kg: 20 mg every week
- ≥ 40 kg: 40 mg every week or 80 mg every other week

Continued therapy should be carefully considered in a subject not responding by Week 12.

There is no relevant use of adalimumab in children aged less than 6 years for this indication.

Paediatric ulcerative colitis

The recommended dose of Hyrimoz for patients from 6 to 17 years of age with ulcerative colitis is based on body weight (Table 5). Hyrimoz is administered via subcutaneous injection.

Table 5. Hyrimoz Dose for Paediatric Patients with Ulcerative Colitis

Patient Weight	Induction Dose	Maintenance Dose Starting at Week 4*
< 40 kg	<ul style="list-style-type: none"> 80 mg at Week 0 (given as two 40 mg injections in one day) and 40 mg at Week 2 (given as one 40 mg injection) 	<ul style="list-style-type: none"> 40 mg every other week
≥ 40 kg	<ul style="list-style-type: none"> 160 mg at Week 0 (given as four 40 mg injections in one day or two 40 mg injections per day for two consecutive days) and 80 mg at Week 2 (given as two 40 mg injections in one day) 	<ul style="list-style-type: none"> 80 mg every other week (given as two 40 mg injections in one day)

* Paediatric patients who turn 18 years of age while on Hyrimoz should continue their prescribed maintenance dose.

Continued therapy beyond 8 weeks should be carefully considered in patients not showing signs of response within this time period.

There is no relevant use of Hyrimoz in children aged less than 6 years in this indication.

Hyrimoz may be available in different strengths and/or pharmaceutical forms depending on the individual treatment needs.

Paediatric uveitis

The recommended dose of Hyrimoz for paediatric patients with uveitis from 2 years of age is based on body weight (Table 6). Hyrimoz is administered via subcutaneous injection.

In paediatric uveitis, there is no experience in the treatment with adalimumab without concomitant treatment with methotrexate.

Table 6. Hyrimoz dose for paediatric patients with uveitis

Patient weight	Dosing regimen
< 30 kg	20 mg every other week in combination with methotrexate
≥ 30 kg	40 mg every other week in combination with methotrexate

When Hyrimoz therapy is initiated, a loading dose of 40 mg for patients < 30 kg or 80 mg for patients ≥ 30 kg may be administered one week prior to the start of maintenance therapy. No clinical data are available on the use of an adalimumab loading dose in children < 6 years of age (see section 5.2).

There is no relevant use of Hyrimoz in children aged less than 2 years in this indication.

It is recommended that the benefit and risk of continued long-term treatment should be evaluated on a yearly basis (see section 5.1).

Psoriatic arthritis and axial spondyloarthritis including ankylosing spondylitis

There is no relevant use of adalimumab in the paediatric population for the indications of ankylosing spondylitis and psoriatic arthritis.

Method of administration

Hyrimoz is administered by subcutaneous injection.
Full instructions for use are provided in the package leaflet.

Adalimumab is available in other strengths and pharmaceutical forms.

4.3 Contraindications

Hypersensitivity to the active substance or to any of the excipients listed in section 6.1.

Active tuberculosis or other severe infections such as sepsis, and opportunistic infections (see section 4.4).

Moderate to severe heart failure (New York Heart Association (NYHA) class III/IV) (see section 4.4).

4.4 Special warnings and precautions for use

Traceability

In order to improve traceability of biological medicinal products, the name and the batch number of the administered product should be clearly recorded.

Infections

Patients taking TNF-antagonists are more susceptible to serious infections. Impaired lung function may increase the risk for developing infections. Patients must therefore be monitored closely for infections, including tuberculosis, before, during and after treatment with Hyrimoz. Because the elimination of adalimumab may take up to four months, monitoring should be continued throughout this period.

Treatment with Hyrimoz should not be initiated in patients with active infections including chronic or localised infections until infections are controlled. In patients who have been exposed to tuberculosis and patients who have travelled in areas of high risk of tuberculosis or endemic mycoses, such as histoplasmosis, coccidioidomycosis, or blastomycosis, the risk and benefits of treatment with Hyrimoz should be considered prior to initiating therapy (see *Other opportunistic infections*).

Patients who develop a new infection while undergoing treatment with Hyrimoz should be monitored closely and undergo a complete diagnostic evaluation. Administration of Hyrimoz should be discontinued if a patient develops a new serious infection or sepsis, and appropriate antimicrobial or antifungal therapy should be initiated until the infection is controlled. Physicians should exercise caution when considering the use of Hyrimoz in patients with a history of recurring infection or with underlying conditions which may predispose patients to infections, including the use of concomitant immunosuppressive medicinal products.

Serious infections

Serious infections, including sepsis, due to bacterial, mycobacterial, invasive fungal, parasitic, viral, or other opportunistic infections such as listeriosis, legionellosis and pneumocystis have been reported in patients receiving adalimumab.

Other serious infections seen in clinical studies include pneumonia, pyelonephritis, septic arthritis

and septicaemia. Hospitalisation or fatal outcomes associated with infections have been reported.

Tuberculosis

Tuberculosis, including reactivation and new onset of tuberculosis, has been reported in patients receiving adalimumab. Reports included cases of pulmonary and extra-pulmonary (i.e. disseminated) tuberculosis.

Before initiation of therapy with Hyrimoz, all patients must be evaluated for both active and inactive (“latent”) tuberculosis infection. This evaluation should include a detailed medical assessment of patient history of tuberculosis or possible previous exposure to people with active tuberculosis and previous and/or current immunosuppressive therapy. Appropriate screening tests (i.e. tuberculin skin test and chest X-ray) should be performed in all patients (local recommendations may apply). It is recommended that the conduct and results of these tests are recorded in the Patient Reminder Card. Prescribers are reminded of the risk of false negative tuberculin skin test results, especially in patients who are severely ill or immunocompromised.

If active tuberculosis is diagnosed, Hyrimoz therapy must not be initiated (see section 4.3).

In all situations described below, the benefit/risk balance of therapy should be very carefully considered.

If latent tuberculosis is suspected, a physician with expertise in the treatment of tuberculosis should be consulted.

If latent tuberculosis is diagnosed, appropriate treatment must be started with anti-tuberculosis prophylaxis treatment before the initiation of Hyrimoz, and in accordance with local recommendations.

Use of anti-tuberculosis prophylaxis treatment should also be considered before the initiation of Hyrimoz in patients with several or significant risk factors for tuberculosis despite a negative test for tuberculosis and in patients with a past history of latent or active tuberculosis in whom an adequate course of treatment cannot be confirmed.

Despite prophylactic treatment for tuberculosis, cases of reactivated tuberculosis have occurred in patients treated with adalimumab. Some patients who have been successfully treated for active tuberculosis have redeveloped tuberculosis while being treated with adalimumab.

Patients should be instructed to seek medical advice if signs/symptoms suggestive of a tuberculosis infection (e.g., persistent cough, wasting/weight loss, low grade fever, listlessness) occur during or after therapy with Hyrimoz.

Other opportunistic infections

Opportunistic infections, including invasive fungal infections have been observed in patients receiving adalimumab. These infections have not consistently been recognised in patients taking TNF-antagonists and this has resulted in delays in appropriate treatment, sometimes resulting in fatal outcomes.

For patients who develop the signs and symptoms such as fever, malaise, weight loss, sweats, cough, dyspnoea, and/or pulmonary infiltrates or other serious systemic illness with or without concomitant shock an invasive fungal infection should be suspected and administration of Hyrimoz should be promptly discontinued. Diagnosis and administration of empiric antifungal therapy in these patients should be made in consultation with a physician with expertise in the care of patients with invasive fungal infections.

Hepatitis B reactivation

Reactivation of hepatitis B has occurred in patients receiving a TNF-antagonist including adalimumab, who are chronic carriers of this virus (i.e. surface antigen positive). Some cases have had a fatal outcome. Patients should be tested for HBV infection before initiating treatment with Hyrimoz. For patients who test positive for hepatitis B infection, consultation with a physician with expertise in the treatment of hepatitis B is recommended.

Carriers of HBV who require treatment with Hyrimoz should be closely monitored for signs and symptoms of active HBV infection throughout therapy and for several months following termination of therapy. Adequate data from treating patients who are carriers of HBV with anti-viral therapy in conjunction with TNF-antagonist therapy to prevent HBV reactivation are not available. In patients who develop HBV reactivation, Hyrimoz should be stopped and effective anti-viral therapy with appropriate supportive treatment should be initiated.

Neurological events

TNF-antagonists including adalimumab have been associated in rare instances with new onset or exacerbation of clinical symptoms and/or radiographic evidence of central nervous system demyelinating disease including multiple sclerosis and optic neuritis, and peripheral demyelinating disease, including Guillain-Barré syndrome. Prescribers should exercise caution in considering the use of Hyrimoz in patients with pre-existing or recent-onset central or peripheral nervous system demyelinating disorders; discontinuation of Hyrimoz should be considered if any of these disorders develop. There is a known association between intermediate uveitis and central demyelinating disorders. Neurologic evaluation should be performed in patients with non-infectious intermediate uveitis prior to the initiation of Hyrimoz therapy and regularly during treatment to assess for pre-existing or developing central demyelinating disorders.

Allergic reactions

Serious allergic reactions associated with adalimumab were rare during clinical studies. Non-serious allergic reactions associated with adalimumab were uncommon during clinical studies. Reports of serious allergic reactions including anaphylaxis have been received following adalimumab administration. If an anaphylactic reaction or other serious allergic reaction occurs, administration of Hyrimoz should be discontinued immediately and appropriate therapy initiated.

Immunosuppression

In a study of 64 patients with rheumatoid arthritis that were treated with adalimumab, there was no evidence of depression of delayed-type hypersensitivity, depression of immunoglobulin levels, or change in enumeration of effector T-, B-, NK-cells, monocyte/macrophages, and neutrophils.

Malignancies and lymphoproliferative disorders

In the controlled portions of clinical studies of TNF-antagonists, more cases of malignancies including lymphoma have been observed among patients receiving a TNF-antagonist compared with control patients. However, the occurrence was rare. In the post marketing setting, cases of leukaemia have been reported in patients treated with a TNF-antagonist. There is an increased background risk for lymphoma and leukaemia in rheumatoid arthritis patients with long-standing, highly active, inflammatory disease, which complicates the risk estimation. With the current knowledge, a possible risk for the development of lymphomas, leukaemia, and other malignancies in patients treated with a TNF-antagonist cannot be excluded.

Malignancies, some fatal, have been reported among children, adolescents and young adults (up to 22 years of age) treated with TNF-antagonists (initiation of therapy \leq 18 years of age), including adalimumab in the post marketing setting. Approximately half the cases were lymphomas. The other cases represented a variety of different malignancies and included rare malignancies usually

associated with immunosuppression. A risk for the development of malignancies in children and adolescents treated with TNF-antagonists cannot be excluded.

Rare postmarketing cases of hepatosplenic T-cell lymphoma have been identified in patients treated with adalimumab. This rare type of T-cell lymphoma has a very aggressive disease course and is usually fatal. Some of these hepatosplenic T-cell lymphomas with adalimumab have occurred in young adult patients on concomitant treatment with azathioprine or 6-mercaptopurine used for inflammatory bowel disease. The potential risk with the combination of azathioprine or 6-mercaptopurine and Hyrimoz should be carefully considered. A risk for the development of hepatosplenic T-cell lymphoma in patients treated with Hyrimoz cannot be excluded (see section 4.8).

No studies have been conducted that include patients with a history of malignancy or in whom treatment with adalimumab is continued following development of malignancy. Thus additional caution should be exercised in considering Hyrimoz treatment of these patients (see section 4.8).

All patients, and in particular patients with a medical history of extensive immunosuppressant therapy or psoriasis patients with a history of PUVA treatment should be examined for the presence of non-melanoma skin cancer prior to and during treatment with Hyrimoz. Melanoma and Merkel cell carcinoma have also been reported in patients treated with TNF-antagonists including adalimumab (see section 4.8).

In an exploratory clinical study evaluating the use of another TNF-antagonist, infliximab, in patients with moderate to severe chronic obstructive pulmonary disease (COPD), more malignancies, mostly in the lung or head and neck, were reported in infliximab-treated patients compared with control patients. All patients had a history of heavy smoking. Therefore, caution should be exercised when using any TNF-antagonist in COPD patients, as well as in patients with increased risk for malignancy due to heavy smoking.

With current data it is not known if adalimumab treatment influences the risk for developing dysplasia or colon cancer. All patients with ulcerative colitis who are at increased risk for dysplasia or colon carcinoma (for example, patients with long-standing ulcerative colitis or primary sclerosing cholangitis), or who had a prior history of dysplasia or colon carcinoma should be screened for dysplasia at regular intervals before therapy and throughout their disease course. This evaluation should include colonoscopy and biopsies per local recommendations.

Haematologic reactions

Rare reports of pancytopenia including aplastic anaemia have been reported with TNF-antagonists. Adverse events of the haematologic system, including medically significant cytopenia (e.g. thrombocytopenia, leukopenia) have been reported with adalimumab. All patients should be advised to seek immediate medical attention if they develop signs and symptoms suggestive of blood dyscrasias (e.g. persistent fever, bruising, bleeding, pallor) while on Hyrimoz. Discontinuation of Hyrimoz therapy should be considered in patients with confirmed significant haematologic abnormalities.

Vaccinations

Similar antibody responses to the standard 23-valent pneumococcal vaccine and the influenza trivalent virus vaccination were observed in a study in 226 adult subjects with rheumatoid arthritis who were treated with adalimumab or placebo. No data are available on the secondary transmission of infection by live vaccines in patients receiving adalimumab.

It is recommended that paediatric patients, if possible, be brought up to date with all immunisations in agreement with current immunisation guidelines prior to initiating Hyrimoz therapy.

Patients on Hyrimoz may receive concurrent vaccinations, except for live vaccines. Administration of live vaccines (e.g., BCG vaccine) to infants exposed to adalimumab *in utero* is not recommended for 5 months following the mother's last adalimumab injection during pregnancy.

Congestive heart failure

In a clinical study with another TNF-antagonist worsening congestive heart failure and increased mortality due to congestive heart failure have been observed. Cases of worsening congestive heart failure have also been reported in patients receiving adalimumab. Hyrimoz should be used with caution in patients with mild heart failure (NYHA class I/II). Hyrimoz is contraindicated in moderate to severe heart failure (see section 4.3). Treatment with Hyrimoz must be discontinued in patients who develop new or worsening symptoms of congestive heart failure.

Autoimmune processes

Treatment with Hyrimoz may result in the formation of autoimmune antibodies. The impact of long-term treatment with adalimumab on the development of autoimmune diseases is unknown. If a patient develops symptoms suggestive of a lupus-like syndrome following treatment with Hyrimoz and is positive for antibodies against double-stranded DNA, further treatment with Hyrimoz should not be given (see section 4.8).

Concurrent administration of biologic DMARDs or TNF-antagonists

Serious infections were seen in clinical studies with concurrent use of anakinra and another TNF-antagonist, etanercept, with no added clinical benefit compared to etanercept alone. Because of the nature of the adverse events seen with the combination of etanercept and anakinra therapy, similar toxicities may also result from the combination of anakinra and other TNF-antagonists. Therefore, the combination of adalimumab and anakinra is not recommended (see section 4.5).

Concomitant administration of adalimumab with other biologic DMARDs (e.g., anakinra and abatacept) or other TNF-antagonists is not recommended based upon the possible increased risk for infections, including serious infections and other potential pharmacological interactions (see section 4.5).

Surgery

There is limited safety experience of surgical procedures in patients treated with adalimumab. The long half-life of adalimumab should be taken into consideration if a surgical procedure is planned. A patient who requires surgery while on Hyrimoz should be closely monitored for infections, and appropriate actions should be taken. There is limited safety experience in patients undergoing arthroplasty while receiving adalimumab.

Small bowel obstruction

Failure to respond to treatment for Crohn's disease may indicate the presence of fixed fibrotic stricture that may require surgical treatment. Available data suggest that adalimumab does not worsen or cause strictures.

Elderly

The frequency of serious infections among adalimumab-treated subjects over 65 years of age (3.7 %) was higher than for those under 65 years of age (1.5 %). Some of those had a fatal outcome. Particular attention regarding the risk for infection should be paid when treating the elderly.

Paediatric population

See Vaccinations above.

Sodium content

This medicinal product contains less than 1 mmol sodium (23 mg) per 0.8 ml dose respectively per 0.4 ml dose, that is to say essentially 'sodium-free'.

4.5 Interaction with other medicinal products and other forms of interaction

Adalimumab has been studied in rheumatoid arthritis, polyarticular juvenile idiopathic arthritis and psoriatic arthritis patients taking adalimumab as monotherapy and those taking concomitant methotrexate. Antibody formation was lower when adalimumab was given together with methotrexate in comparison with use as monotherapy. Administration of adalimumab without methotrexate resulted in increased formation of antibodies, increased clearance and reduced efficacy of adalimumab (see section 5.1).

The combination of adalimumab and anakinra is not recommended (see section 4.4 "Concurrent administration of biologic DMARDs or TNF-antagonists").

The combination of adalimumab and abatacept is not recommended (see section 4.4 "Concurrent administration of biologic DMARDs or TNF-antagonists").

4.6 Fertility, pregnancy and lactation

Women of childbearing potential

Women of childbearing potential should consider the use of adequate contraception to prevent pregnancy and continue its use for at least five months after the last Hyrimoz treatment.

Pregnancy

A large number (approximately 2 100) of prospectively collected pregnancies exposed to adalimumab resulting in live birth with known outcomes, including more than 1 500 exposed during the first trimester, does not indicate an increase in the rate of malformation in the newborn.

In a prospective cohort registry, 257 women with rheumatoid arthritis (RA) or Crohn's disease (CD) treated with adalimumab at least during the first trimester and 120 women with RA or CD not treated with adalimumab were enrolled. The primary endpoint was the birth prevalence of major birth defects. The rate of pregnancies ending with at least one live born infant with a major birth defect was 6/69 (8.7 %) in the adalimumab-treated women with RA and 5/74 (6.8 %) in the untreated women with RA (unadjusted OR 1.31, 95 % CI 0.38–4.52) and 16/152 (10.5 %) in the adalimumab-treated women with CD and 3/32 (9.4 %) in the untreated women with CD (unadjusted OR 1.14, 95 % CI 0.31–4.16). The adjusted OR (accounting for baseline differences) was 1.10 (95 % CI 0.45–2.73) with RA and CD combined. There were no distinct differences between adalimumab-treated and untreated women for the secondary endpoints spontaneous abortions, minor birth defects, preterm delivery, birth size and serious or opportunistic infections and no stillbirths or malignancies were reported. The interpretation of data may be impacted due to methodological limitations of the study, including small sample size and non-randomized design.

In a developmental toxicity study conducted in monkeys, there was no indication of maternal toxicity, embryotoxicity or teratogenicity. Preclinical data on postnatal toxicity of adalimumab are not available (see section 5.3).

Due to its inhibition of TNF α , adalimumab administered during pregnancy could affect normal immune responses in the newborn. Adalimumab should only be used during pregnancy if clearly needed.

Adalimumab may cross the placenta into the serum of infants born to women treated with adalimumab during pregnancy. Consequently, these infants may be at increased risk for infection.

Administration of live vaccines (e.g., BCG vaccine) to infants exposed to adalimumab *in utero* is not recommended for 5 months following the mother's last adalimumab injection during pregnancy.

Breast-feeding

Limited information from the published literature indicates that adalimumab is excreted in breast milk at very low concentrations with the presence of adalimumab in human milk at concentrations of 0.1 % to 1 % of the maternal serum level. Given orally, immunoglobulin G proteins undergo intestinal proteolysis and have poor bioavailability. No effects on the breastfed newborns/infants are anticipated. Consequently, Hyrimoz can be used during breastfeeding.

Fertility

Preclinical data on fertility effects of adalimumab are not available.

4.7 Effects on ability to drive and use machines

Hyrimoz may have a minor influence on the ability to drive and use machines. Vertigo and visual impairment may occur following administration of Hyrimoz (see section 4.8).

4.8 Undesirable effects

Summary of the safety profile

Adalimumab was studied in 9 506 patients in pivotal controlled and open label studies for up to 60 months or more. These studies included rheumatoid arthritis patients with short term and long standing disease, juvenile idiopathic arthritis (polyarticular juvenile idiopathic arthritis and enthesitis-related arthritis) as well as axial spondyloarthritis (ankylosing spondylitis and axial spondyloarthritis without radiographic evidence of AS), psoriatic arthritis, Crohn's disease, ulcerative colitis, psoriasis, hidradenitis suppurativa and uveitis patients. The pivotal controlled studies involved 6 089 patients receiving adalimumab and 3 801 patients receiving placebo or active comparator during the controlled period.

The proportion of patients who discontinued treatment due to adverse events during the double-blind, controlled portion of pivotal studies was 5.9 % for patients taking adalimumab and 5.4 % for control-treated patients.

The most commonly reported adverse reactions are infections (such as nasopharyngitis, upper respiratory tract infection and sinusitis), injection site reactions (erythema, itching, haemorrhage, pain or swelling), headache and musculoskeletal pain.

Serious adverse reactions have been reported for adalimumab. TNF-antagonists, such as adalimumab affect the immune system and their use may affect the body's defence against infection and cancer.

Fatal and life-threatening infections (including sepsis, opportunistic infections and TB), HBV reactivation and various malignancies (including leukaemia, lymphoma and HSTCL) have also been reported with use of adalimumab.

Serious haematological, neurological and autoimmune reactions have also been reported. These include rare reports of pancytopenia, aplastic anaemia, central and peripheral demyelinating events and reports of lupus, lupus-related conditions and Stevens-Johnson syndrome.

Paediatric population

In general, the adverse events in paediatric patients were similar in frequency and type to those seen in adult patients.

Tabulated list of adverse reactions

The following list of adverse reactions is based on experience from clinical studies and on postmarketing experience and are displayed by system organ class (SOC) and frequency in Table 7 below: very common ($\geq 1/10$); common ($\geq 1/100$ to $< 1/10$); uncommon ($\geq 1/1\ 000$ to $< 1/100$); rare ($\geq 1/10\ 000$ to $< 1/1\ 000$); and not known (cannot be estimated from the available data). Within each frequency grouping, adverse reactions are presented in order of decreasing seriousness.

The highest frequency seen among the various indications has been included. An asterisk (*) appears in the SOC column if further information is found elsewhere in sections 4.3, 4.4 and 4.8.

Table 7. Adverse reactions

System Organ Class	Frequency	Adverse Reaction
Infections and infestations*	Very common	Respiratory tract infections (including lower and upper respiratory tract infection, pneumonia, sinusitis, pharyngitis, nasopharyngitis and pneumonia herpes viral)
	Common	Systemic infections (including sepsis, candidiasis and influenza), intestinal infections (including gastroenteritis viral), skin and soft tissue infections (including paronychia, cellulitis, impetigo, necrotising fasciitis and herpes zoster), ear infections, oral infections (including herpes simplex, oral herpes and tooth infections), reproductive tract infections (including vulvovaginal mycotic infection), urinary tract infections (including pyelonephritis), fungal infections, joint infections
	Uncommon	Neurological infections (including viral meningitis), opportunistic infections and tuberculosis (including coccidioidomycosis, histoplasmosis and mycobacterium avium complex infection), bacterial infections, eye infections, diverticulitis ¹⁾
Neoplasms benign, malignant and unspecified (including cysts and polyps)*	Common	Skin cancer excluding melanoma (including basal cell carcinoma and squamous cell carcinoma) benign neoplasm
	Uncommon	Lymphoma**, solid organ neoplasm (including breast cancer, lung neoplasm and thyroid neoplasm), melanoma**
	Rare	Leukaemia ¹⁾

System Organ Class	Frequency	Adverse Reaction
	Not known	Hepatosplenic T-cell lymphoma ¹⁾ Merkel cell carcinoma (neuroendocrine carcinoma of the skin) ¹⁾ Kaposi`s sarcoma
Blood and the lymphatic system disorders*	Very common	Leucopaenia (including neutropaenia and agranulocytosis), anaemia
	Common	Leucocytosis, thrombocytopaenia
	Uncommon	Idiopathic thrombocytopaenic purpura
	Rare	Pancytopaenia
Immune system disorders*	Common	Hypersensitivity, allergies (including seasonal allergy)
	Uncommon	Sarcoidosis ¹⁾ , vasculitis
	Rare	Anaphylaxis ¹⁾
Metabolism and nutrition disorders	Very common	Lipids increased
	Common	Hypokalaemia, uric acid increased, blood sodium abnormal, hypocalcaemia, hyperglycaemia, hypophosphataemia, dehydration
Psychiatric disorders	Common	Mood alterations (including depression), anxiety, insomnia
Nervous system disorders*	Very common	Headache
	Common	Paraesthesias (including hypoaesthesia), migraine, nerve root compression
	Uncommon	Cerebrovascular accident ¹⁾ , tremor, neuropathy
	Rare	Multiple sclerosis, demyelinating disorders (e.g. optic neuritis, Guillain-Barré syndrome) ¹⁾
Eye disorders	Common	Visual impairment, conjunctivitis, blepharitis, eye swelling

System Organ Class	Frequency	Adverse Reaction
	Uncommon	Diplopia
Ear and labyrinth disorders	Common	Vertigo
	Uncommon	Deafness, tinnitus
Cardiac disorders*	Common	Tachycardia
	Uncommon	Myocardial infarction ¹⁾ , arrhythmia, congestive heart failure
	Rare	Cardiac arrest
Vascular disorders	Common	Hypertension, flushing, haematoma
	Uncommon	Aortic aneurysm, vascular arterial occlusion, thrombophlebitis
Respiratory, thoracic and mediastinal disorders*	Common	Asthma, dyspnoea, cough
	Uncommon	Pulmonary embolism ¹⁾ , interstitial lung disease, chronic obstructive pulmonary disease, pneumonitis, pleural effusion ¹⁾
	Rare	Pulmonary fibrosis ¹⁾
Gastrointestinal disorders	Very common	Abdominal pain, nausea and vomiting
	Common	GI haemorrhage, dyspepsia, gastroesophageal reflux disease, sicca syndrome
	Uncommon	Pancreatitis, dysphagia, face oedema
	Rare	Intestinal perforation ¹⁾

System Organ Class	Frequency	Adverse Reaction
Hepato-biliary disorders*	Very common	Elevated liver enzymes
	Uncommon	Cholecystitis and cholelithiasis, hepatic steatosis, bilirubin increased
	Rare	Hepatitis, reactivation of hepatitis B ¹⁾ , autoimmune hepatitis ¹⁾
	Not known	Liver failure ¹⁾
Skin and subcutaneous tissue disorders	Very common	Rash (including exfoliative rash)
	Common	Worsening or new onset of psoriasis (including palmoplantar pustular psoriasis) ¹⁾ , urticaria, bruising (including purpura), dermatitis (including eczema), onychoclasia, hyperhidrosis, alopecia ¹⁾ , pruritus
	Uncommon	Night sweats, scar
	Rare	Erythema multiforme ¹⁾ , Stevens-Johnson syndrome ¹⁾ , angioedema ¹⁾ , cutaneous vasculitis ¹⁾ lichenoid skin reaction ¹⁾
	Not known	Worsening of symptoms of dermatomyositis ¹⁾
Musculoskeletal and connective tissue disorders	Very common	Musculoskeletal pain
	Common	Muscle spasms (including blood creatine phosphokinase increased)
	Uncommon	Rhabdomyolysis, systemic lupus erythematosus
	Rare	Lupus-like syndrome ¹⁾
Renal and urinary disorders	Common	Renal impairment, haematuria
	Uncommon	Nocturia
Reproductive system and breast disorders	Uncommon	Erectile dysfunction

System Organ Class	Frequency	Adverse Reaction
General disorders and administration site conditions*	Very common	Injection site reaction (including injection site erythema)
	Common	Chest pain, oedema, pyrexia ¹⁾
	Uncommon	Inflammation
Investigations*	Common	Coagulation and bleeding disorders (including activated partial thromboplastin time prolonged), autoantibody test positive (including double stranded DNA antibody), blood lactate dehydrogenase increased
	Not known	Weight increased ²⁾
Injury, poisoning and procedural complications	Common	Impaired healing

* further information is found elsewhere in sections 4.3, 4.4 and 4.8

** including open label extension studies

1) including spontaneous reporting data

2) The mean weight change from baseline for adalimumab ranged from 0.3 kg to 1.0 kg across adult indications compared to (minus) -0.4 kg to 0.4 kg for placebo over a treatment period of 4-6 months. Weight increase of 5-6 kg has also been observed in long-term extension studies with mean exposures of approximately 1-2 years without control group, particularly in patients with Crohn's disease and ulcerative colitis. The mechanism behind this effect is unclear but could be associated with the anti-inflammatory effect of adalimumab.

Hidradenitis suppurativa

The safety profile for patients with HS treated with adalimumab weekly was consistent with the known safety profile of adalimumab.

Uveitis

The safety profile for patients with uveitis treated with adalimumab every other week was consistent with the known safety profile of adalimumab.

Description of selected adverse reactions

Injection site reactions

In the pivotal controlled studies in adults and children, 12.9 % of patients treated with adalimumab developed injection site reactions (erythema and/or itching, haemorrhage, pain or swelling), compared to 7.2 % of patients receiving placebo or active control. Injection site reactions generally did not necessitate discontinuation of the medicinal product.

Infections

In the pivotal controlled studies in adults and children, the rate of infection was 1.51 per patient year in the adalimumab-treated patients and 1.46 per patient year in the placebo and active control-treated patients. The infections consisted primarily of nasopharyngitis, upper respiratory tract infection, and sinusitis. Most patients continued on adalimumab after the infection resolved.

The incidence of serious infections was 0.04 per patient year in adalimumab-treated patients and 0.03 per patient year in placebo and active control-treated patients.

In controlled and open label adult and paediatric studies with adalimumab, serious infections (including fatal infections, which occurred rarely) have been reported, which include reports of tuberculosis (including miliary and extra-pulmonary locations) and invasive opportunistic infections (e.g. disseminated or extrapulmonary histoplasmosis, blastomycosis, coccidioidomycosis, pneumocystis, candidiasis, aspergillosis and listeriosis). Most of the cases of tuberculosis occurred within the first eight months after initiation of therapy and may reflect recrudescence of latent disease.

Malignancies and lymphoproliferative disorders

No malignancies were observed in 249 paediatric patients with an exposure of 655.6 patient years during adalimumab studies in patients with juvenile idiopathic arthritis (polyarticular juvenile idiopathic arthritis and enthesitis-related arthritis). In addition, no malignancies were observed in 192 paediatric patients with an exposure of 498.1 patient years during adalimumab studies in paediatric patients with Crohn's disease. No malignancies were observed in 77 paediatric patients with an exposure of 80.0 patient years during an adalimumab study in paediatric patients with chronic plaque psoriasis. No malignancies were observed in 93 paediatric patients with an exposure of 65.3 patient years during an adalimumab study in paediatric patients with ulcerative colitis. No malignancies were observed in 60 paediatric patients with an exposure of 58.4 patient years during an adalimumab study in paediatric patients with uveitis.

During the controlled portions of pivotal adalimumab studies in adults of at least 12 weeks in duration in patients with moderately to severely active rheumatoid arthritis, ankylosing spondylitis, axial spondyloarthritis without radiographic evidence of AS, psoriatic arthritis, psoriasis, hidradenitis suppurativa, Crohn's disease, ulcerative colitis and uveitis, malignancies, other than lymphoma and non-melanoma skin cancer, were observed at a rate (95 % confidence interval) of 6.8 (4.4, 10.5) per 1 000 patient years among 5 291 adalimumab-treated patients *versus* a rate of 6.3 (3.4, 11.8) per 1 000 patient years among 3 444 control patients (median duration of treatment was 4.0 months for adalimumab and 3.8 months for control-treated patients). The rate (95 % confidence interval) of non-melanoma skin cancers was 8.8 (6.0, 13.0) per 1 000 patient years among adalimumab-treated patients and 3.2 (1.3, 7.6) per 1 000 patient years among control patients. Of these skin cancers, squamous cell carcinomas occurred at rates (95 % confidence interval) of 2.7 (1.4, 5.4) per 1 000 patient years among adalimumab-treated patients and 0.6 (0.1, 4.5) per 1 000 patient years among control patients. The rate (95 % confidence interval) of lymphomas was 0.7 (0.2, 2.7) per 1 000 patient years among adalimumab-treated patients and 0.6 (0.1, 4.5) per 1 000 patient years among control patients.

When combining controlled portions of these studies and ongoing and completed open label extension studies with a median duration of approximately 3.3 years including 6 427 patients and over 26 439 patient years of therapy, the observed rate of malignancies, other than lymphoma and non-melanoma skin cancers is approximately 8.5 per 1 000 patient years. The observed rate of non-melanoma skin cancers is approximately 9.6 per 1 000 patient years, and the observed rate of lymphomas is approximately 1.3 per 1 000 patient years.

In post-marketing experience from January 2003 to December 2010, predominantly in patients with rheumatoid arthritis, the spontaneously reported rate of malignancies is approximately 2.7 per 1 000 patient treatment years. The spontaneously reported rates for non-melanoma skin cancers and lymphomas are approximately 0.2 and 0.3 per 1 000 patient treatment years, respectively (see section 4.4).

Rare post-marketing cases of hepatosplenic T-cell lymphoma have been reported in patients treated with adalimumab (see section 4.4).

Autoantibodies

Patients had serum samples tested for autoantibodies at multiple time points in rheumatoid arthritis studies I–V. In these studies, 11.9 % of patients treated with adalimumab and 8.1 % of placebo and active control-treated patients that had negative baseline anti-nuclear antibody titres reported positive titres at Week 24. Two patients out of 3 441 treated with adalimumab in all rheumatoid arthritis and psoriatic arthritis studies developed clinical signs suggestive of new-onset lupus-like syndrome. The patients improved following discontinuation of therapy. No patients developed lupus nephritis or central nervous system symptoms.

Hepato-biliary events

In controlled Phase 3 studies of adalimumab in patients with rheumatoid arthritis and psoriatic arthritis with a control period duration ranging from 4 to 104 weeks, ALT elevations ≥ 3 x ULN occurred in 3.7 % of adalimumab-treated patients and 1.6 % of control-treated patients.

In controlled Phase 3 studies of adalimumab in patients with polyarticular juvenile idiopathic arthritis who were 4 to 17 years and enthesitis-related arthritis who were 6 to 17 years, ALT elevations ≥ 3 x ULN occurred in 6.1 % of adalimumab-treated patients and 1.3 % of control-treated patients. Most ALT elevations occurred with concomitant methotrexate use. No ALT elevations ≥ 3 x ULN occurred in the Phase 3 study of adalimumab in patients with polyarticular juvenile idiopathic arthritis who were 2 to < 4 years.

In controlled Phase 3 studies of adalimumab in patients with Crohn's disease and ulcerative colitis with a control period ranging from 4 to 52 weeks. ALT elevations ≥ 3 x ULN occurred in 0.9 % of adalimumab-treated patients and 0.9 % of controlled-treated patients.

In the Phase 3 study of adalimumab in patients with paediatric Crohn's disease which evaluated efficacy and safety of two body weight adjusted maintenance dose regimens following body weight adjusted induction therapy up to 52 weeks of treatment, ALT elevations ≥ 3 x ULN occurred in 2.6 % (5/192) of patients of whom 4 were receiving concomitant immunosuppressants at baseline.

In controlled Phase 3 studies of adalimumab in patients with plaque Psoriasis with a control period duration ranging from 12 to 24 weeks, ALT elevations ≥ 3 x ULN occurred in 1.8 % of adalimumab-treated patients and 1.8 % of control-treated patients.

No ALT elevations ≥ 3 x ULN occurred in the Phase 3 study of adalimumab in paediatric patients with plaque psoriasis.

In controlled studies of adalimumab (initial doses of 160 mg at Week 0 and 80 mg at Week 2, followed by 40 mg every week starting at Week 4), in patients with hidradenitis suppurativa with a control period duration ranging from 12 to 16 weeks, ALT elevations ≥ 3 x ULN occurred in 0.3 % of adalimumab-treated patients and 0.6 % of control-treated patients.

In controlled studies of adalimumab (initial doses of 80 mg at Week 0 followed by 40 mg every other week starting at Week 1) in adult patients with uveitis up to 80 weeks with a median exposure of 166.5 days and 105.0 days in adalimumab-treated and control-treated patients, respectively, ALT elevations ≥ 3 x ULN occurred in 2.4 % of adalimumab-treated patients and 2.4 % of control-treated patients.

In the controlled Phase 3 study of adalimumab in patients with paediatric ulcerative colitis (N=93) which evaluated efficacy and safety of a maintenance dose of 0.6 mg/kg (maximum of 40 mg) every other week (N=31) and a maintenance dose of 0.6 mg/kg (maximum of 40 mg) every week (N=32), following body weight adjusted induction dosing of 2.4 mg/kg (maximum of 160 mg) at Week 0 and Week 1, and 1.2 mg/kg (maximum of 80 mg) at Week 2 (N=63), or an induction dose of 2.4 mg/kg (maximum of 160 mg) at Week 0, placebo at Week 1, and 1.2 mg/kg (maximum of 80 mg) at Week 2 (N=30), ALT elevations ≥ 3 X ULN occurred in 1.1 % (1/93) of patients.

Across all indications in clinical studies patients with raised ALT were asymptomatic and in most cases elevations were transient and resolved on continued treatment. However, there have also been post-marketing reports of liver failure as well as less severe liver disorders that may precede liver failure, such as hepatitis including autoimmune hepatitis in patients receiving adalimumab.

Concurrent treatment with azathioprine/6-mercaptopurine

In adult Crohn's disease studies, higher incidences of malignant and serious infection-related adverse events were seen with the combination of adalimumab and azathioprine/6-mercaptopurine compared with adalimumab alone.

Reporting of suspected adverse reactions

Reporting suspected adverse reactions after authorisation of the medicinal product is important. It allows continued monitoring of the benefit/risk balance of the medicinal product. Healthcare professionals are asked to report any suspected adverse reactions via the national reporting system listed in Appendix V.

4.9 Overdose

No dose-limiting toxicity was observed during clinical studies. The highest dose level evaluated has been multiple intravenous doses of 10 mg/kg, which is approximately 15 times the recommended dose.

5. PHARMACOLOGICAL PROPERTIES

5.1 Pharmacodynamic properties

Pharmacotherapeutic group: Immunosuppressants, Tumour Necrosis Factor alpha (TNF- α) inhibitors, ATC code: L04AB04

Hyrimoz is a biosimilar medicinal product. Detailed information is available on the website of the European Medicines Agency <https://www.ema.europa.eu>.

Mechanism of action

Adalimumab binds specifically to TNF and neutralises the biological function of TNF by blocking its interaction with the p55 and p75 cell surface TNF receptors.

Adalimumab also modulates biological responses that are induced or regulated by TNF, including changes in the levels of adhesion molecules responsible for leukocyte migration (ELAM-1, VCAM-1, and ICAM-1 with an IC_{50} of 0.1–0.2 nM).

Pharmacodynamic effects

After treatment with adalimumab, a rapid decrease in levels of acute phase reactants of inflammation (C-reactive protein (CRP) and erythrocyte sedimentation rate (ESR)) and serum cytokines (IL-6) was observed, compared to baseline in patients with rheumatoid arthritis. Serum levels of matrix metalloproteinases (MMP-1 and MMP-3) that produce tissue remodelling responsible for cartilage destruction were also decreased after adalimumab administration. Patients treated with adalimumab usually experienced improvement in haematological signs of chronic inflammation.

A rapid decrease in CRP levels was also observed in patients with polyarticular juvenile idiopathic arthritis, Crohn's disease, ulcerative colitis and hidradenitis suppurativa after treatment with adalimumab. In patients with Crohn's disease, a reduction of the number of cells expressing inflammatory markers in the colon including a significant reduction of expression of TNF- α was seen.

Endoscopic studies in intestinal mucosa have shown evidence of mucosal healing in adalimumab-treated patients.

Clinical efficacy and safety

Rheumatoid arthritis

Adalimumab was evaluated in over 3 000 patients in all rheumatoid arthritis clinical studies. The efficacy and safety of adalimumab were assessed in five randomised, double-blind and well-controlled studies. Some patients were treated for up to 120 months duration.

RA study I evaluated 271 patients with moderately to severely active rheumatoid arthritis who were ≥ 18 years old, had failed therapy with at least one disease-modifying, anti-rheumatic drug and had insufficient efficacy with methotrexate at doses of 12.5 to 25 mg (10 mg if methotrexate-intolerant) every week and whose methotrexate dose remained constant at 10 to 25 mg every week. Doses of 20, 40 or 80 mg of adalimumab or placebo were given every other week for 24 weeks.

RA study II evaluated 544 patients with moderately to severely active rheumatoid arthritis who were ≥ 18 years old and had failed therapy with at least one disease-modifying, anti-rheumatic drugs. Doses of 20 or 40 mg of adalimumab were given by subcutaneous injection every other week with placebo on alternative weeks or every week for 26 weeks; placebo was given every week for the same duration. No other disease-modifying anti-rheumatic drugs were allowed.

RA study III evaluated 619 patients with moderately to severely active rheumatoid arthritis who were ≥ 18 years old, and who had an ineffective response to methotrexate at doses of 12.5 to 25 mg or have been intolerant to 10 mg of methotrexate every week. There were three groups in this study. The first received placebo injections every week for 52 weeks. The second received 20 mg of adalimumab every week for 52 weeks. The third group received 40 mg of adalimumab every other week with placebo injections on alternate weeks. Upon completion of the first 52 weeks, 457 patients enrolled in an open-label extension phase in which 40 mg of adalimumab/MTX was administered every other week up to 10 years.

RA study IV primarily assessed safety in 636 patients with moderately to severely active rheumatoid arthritis who were ≥ 18 years old. Patients were permitted to be either disease-modifying, anti-rheumatic drug-naïve or to remain on their pre-existing rheumatologic therapy provided that therapy was stable for a minimum of 28 days. These therapies include methotrexate, leflunomide, hydroxychloroquine, sulfasalazine and/or gold salts. Patients were randomised to 40 mg of adalimumab or placebo every other week for 24 weeks.

RA study V evaluated 799 methotrexate-naïve, adult patients with moderate to severely active early rheumatoid arthritis (mean disease duration less than 9 months). This study evaluated the efficacy of adalimumab 40 mg every other week/methotrexate combination therapy, adalimumab 40 mg every other week monotherapy and methotrexate monotherapy in reducing the signs and symptoms and rate of progression of joint damage in rheumatoid arthritis for 104 weeks. Upon completion of the first 104 weeks, 497 patients enrolled in an open-label extension phase in which 40 mg of adalimumab was administered every other week up to 10 years.

The primary end point in RA studies I, II and III and the secondary endpoint in RA study IV was the percentage of patients who achieved an ACR 20 response at Week 24 or 26. The primary endpoint in RA study V was the percent of patients who achieved an ACR 50 response at Week 52. RA studies III and V had an additional primary endpoint at 52 weeks of retardation of disease progression (as detected by X-ray results). RA study III also had a primary endpoint of changes in quality of life.

ACR response

The percentage of adalimumab-treated patients achieving ACR 20, 50 and 70 responses was consistent across RA studies I, II and III. The results for the 40 mg every other week dose are summarised in

Table 8.

**Table 8. ACR responses in placebo-controlled studies
(percent of patients)**

response	RA Study I ^{a**}		RA Study II ^{a**}		RA Study III ^{a**}	
	placebo/MTX ^c n = 60	adalimumab ^b /M TX ^c n = 63	placebo n = 110	adalimumab ^b n = 113	placebo/MTX ^c n = 200	adalimumab ^b /M TX ^c n = 207
ACR 20						
6 months	13.3 %	65.1 %	19.1 %	46.0 %	29.5 %	63.3 %
12 months	NA	NA	NA	NA	24.0 %	58.9 %
ACR 50						
6 months	6.7 %	52.4 %	8.2 %	22.1 %	9.5 %	39.1 %
12 months	NA	NA	NA	NA	9.5 %	41.5 %
ACR 70						
6 months	3.3 %	23.8 %	1.8 %	12.4 %	2.5 %	20.8 %
12 months	NA	NA	NA	NA	4.5 %	23.2 %

^a RA study I at 24 weeks, RA study II at 26 weeks, and RA study III at 24 and 52 weeks

^b 40 mg adalimumab administered every other week

^c MTX = methotrexate

** p < 0.01, adalimumab *versus* placebo

In RA studies I–IV, all individual components of the ACR response criteria (number of tender and swollen joints, physician and patient assessment of disease activity and pain, disability index (HAQ) scores and CRP (mg/dl) values) improved at 24 or 26 weeks compared to placebo. In RA study III, these improvements were maintained throughout 52 weeks.

In the open-label extension for RA study III, most patients who were ACR responders maintained response when followed for up to 10 years. Of 207 patients who were randomised to adalimumab 40 mg every other week, 114 patients continued on adalimumab 40 mg every other week for 5 years. Among those, 86 patients (75.4 %) had ACR 20 responses; 72 patients (63.2 %) had ACR 50 responses; and 41 patients (36 %) had ACR 70 responses. Of 207 patients, 81 patients continued on adalimumab 40 mg every other week for 10 years. Among those, 64 patients (79.0 %) had ACR 20 responses; 56 patients (69.1 %) had ACR 50 responses; and 43 patients (53.1 %) had ACR 70 responses.

In RA study IV, the ACR 20 response of patients treated with adalimumab plus standard of care was statistically significantly better than patients treated with placebo plus standard of care (p < 0.001).

In RA studies I–IV, adalimumab-treated patients achieved statistically significant ACR 20 and 50 responses compared to placebo as early as one to two weeks after initiation of treatment.

In RA study V with early rheumatoid arthritis patients who were methotrexate naïve, combination therapy with adalimumab and methotrexate led to faster and significantly greater ACR responses than methotrexate monotherapy and adalimumab monotherapy at Week 52 and responses were sustained at Week 104 (see Table 9).

**Table 9. ACR responses in RA study V
(percent of patients)**

response	MTX n = 257	adalimumab n = 274	adalimumab/MT X n = 268	p-value ^a	p-value ^b	p-value ^c
ACR 20						
Week 52	62.6 %	54.4 %	72.8 %	0.013	< 0.001	0.043
Week 104	56.0 %	49.3 %	69.4 %	0.002	< 0.001	0.140
ACR 50						
Week 52	45.9 %	41.2 %	61.6 %	< 0.001	< 0.001	0.317
Week 104	42.8 %	36.9 %	59.0 %	< 0.001	< 0.001	0.162
ACR 70						
Week 52	27.2 %	25.9 %	45.5 %	< 0.001	< 0.001	0.656
Week 104	28.4 %	28.1 %	46.6 %	< 0.001	< 0.001	0.864

^a p-value is from the pairwise comparison of methotrexate monotherapy and adalimumab/methotrexate combination therapy using the Mann-Whitney U test.

^b p-value is from the pairwise comparison of adalimumab monotherapy and adalimumab/methotrexate combination therapy using the Mann-Whitney U test

^c p-value is from the pairwise comparison of adalimumab monotherapy and methotrexate monotherapy using the Mann-Whitney U test

In the open-label extension for RA study V, ACR response rates were maintained when followed for up to 10 years. Of 542 patients who were randomised to adalimumab 40 mg every other week, 170 patients continued on adalimumab 40 mg every other week for 10 years. Among those, 154 patients (90.6 %) had ACR 20 responses; 127 patients (74.7 %) had ACR 50 responses; and 102 patients (60.0 %) had ACR 70 responses.

At Week 52, 42.9 % of patients who received adalimumab/methotrexate combination therapy achieved clinical remission (DAS28 < 2.6) compared to 20.6 % of patients receiving methotrexate monotherapy and 23.4 % of patients receiving adalimumab monotherapy.

Adalimumab/methotrexate combination therapy was clinically and statistically superior to methotrexate (p < 0.001) and adalimumab monotherapy (p < 0.001) in achieving a low disease state in patients with recently diagnosed moderate to severe rheumatoid arthritis. The response for the two monotherapy arms was similar (p = 0.447). Of 342 subjects originally randomized to adalimumab monotherapy or adalimumab/methotrexate combination therapy who entered the open-label extension study, 171 subjects completed 10 years of adalimumab treatment. Among those, 109 subjects (63.7 %) were reported to be in remission at 10 years.

Radiographic response

In RA study III, where adalimumab-treated patients had a mean duration of rheumatoid arthritis of approximately 11 years, structural joint damage was assessed radiographically and expressed as change in modified Total Sharp Score (TSS) and its components, the erosion score and joint space narrowing score. Adalimumab/methotrexate patients demonstrated significantly less radiographic progression than patients receiving methotrexate alone at 6 and 12 months (see Table 10).

In the open-label extension of RA Study III, the reduction in rate of progression of structural damage

is maintained for 8 and 10 years in a subset of patients. At 8 years, 81 of 207 patients originally treated with 40 mg adalimumab every other week were evaluated radiographically. Among those, 48 patients showed no progression of structural damage defined by a change from baseline in the mTSS of 0.5 or less. At 10 years, 79 of 207 patients originally treated with 40 mg adalimumab every other week were evaluated radiographically. Among those, 40 patients showed no progression of structural damage defined by a change from baseline in the mTSS of 0.5 or less.

Table 10. Radiographic mean changes over 12 months in RA study III

	placebo/MTX ^a	adalimumab/MTX 40 mg every other week	placebo/MTX- adalimumab/MTX (95 % confidence interval ^b)	p-value
total Sharp score	2.7	0.1	2.6 (1.4, 3.8)	< 0.001 ^c
erosion score	1.6	0.0	1.6 (0.9, 2.2)	< 0.001
JSN ^d score	1.0	0.1	0.9 (0.3, 1.4)	0.002

^a methotrexate

^b 95 % confidence intervals for the differences in change scores between methotrexate and adalimumab

^c based on rank analysis

^d Joint Space Narrowing

In RA study V, structural joint damage was assessed radiographically and expressed as change in modified total Sharp Score (see Table 11).

Table 11. Radiographic mean changes at Week 52 in RA study V

	MTX n = 257 (95 % confidence interval)	adalimumab n = 274 (95 % confidence interval)	adalimumab/M TX n=268 (95% confidence interval)	p-value ^a	p-value ^b	p-value ^c
total Sharp score	5.7 (4.2–7.3)	3.0 (1.7–4.3)	1.3 (0.5–2.1)	< 0.001	0.0020	< 0.001
erosion score	3.7 (2.7–4.7)	1.7 (1.0–2.4)	0.8 (0.4–1.2)	< 0.001	0.0082	< 0.001
JSN score	2.0 (1.2–2.8)	1.3 (0.5–2.1)	0.5 (0–1.0)	< 0.001	0.0037	0.151

^a p-value is from the pairwise comparison of methotrexate monotherapy and adalimumab/methotrexate combination therapy using the Mann-Whitney U test.

^b p-value is from the pairwise comparison of adalimumab monotherapy and adalimumab/methotrexate combination therapy using the Mann-Whitney U test

^c p-value is from the pairwise comparison of adalimumab monotherapy and methotrexate monotherapy using the Mann-Whitney U test

Following 52 weeks and 104 weeks of treatment, the percentage of patients without progression (change from baseline in modified Total Sharp Score \leq 0.5) was significantly higher with adalimumab/methotrexate combination therapy (63.8 % and 61.2 % respectively) compared to methotrexate monotherapy (37.4 % and 33.5 % respectively, $p < 0.001$) and adalimumab monotherapy (50.7 %, $p < 0.002$ and 44.5 %, $p < 0.001$ respectively).

In the open-label extension of RA study V, the mean change from baseline at Year 10 in the modified Total Sharp Score was 10.8, 9.2 and 3.9 in patients originally randomised to methotrexate monotherapy, adalimumab monotherapy and adalimumab/methotrexate combination therapy,

respectively. The corresponding proportions of patients with no radiographic progression were 31.3 %, 23.7 % and 36.7 % respectively.

Quality of life and physical function

Health-related quality of life and physical function were assessed using the disability index of the Health Assessment Questionnaire (HAQ) in the four original adequate and well-controlled studies, which was a pre-specified primary endpoint at Week 52 in RA study III. All doses/schedules of adalimumab in all four studies showed statistically significantly greater improvement in the disability index of the HAQ from baseline to Month 6 compared to placebo and in RA study III the same was seen at Week 52. Results from the Short Form Health Survey (SF 36) for all doses/schedules of adalimumab in all four studies support these findings, with statistically significant physical component summary (PCS) scores, as well as statistically significant pain and vitality domain scores for the 40 mg every other week dose. A statistically significant decrease in fatigue as measured by functional assessment of chronic illness therapy (FACIT) scores was seen in all three studies in which it was assessed (RA studies I, III, IV).

In RA study III, most subjects who achieved improvement in physical function and continued treatment maintained improvement through Week 520 (120 months) of open-label treatment. Improvement in quality of life was measured up to Week 156 (36 months) and improvement was maintained through that time.

In RA study V, the improvement in the HAQ disability index and the physical component of the SF 36 showed greater improvement ($p < 0.001$) for adalimumab/methotrexate combination therapy *versus* methotrexate monotherapy and adalimumab monotherapy at Week 52, which was maintained through Week 104. Among the 250 subjects who completed the open-label extension study, improvements in physical function were maintained through 10 years of treatment.

Axial spondyloarthritis

Ankylosing spondylitis (AS)

Adalimumab 40 mg every other week was assessed in 393 patients in two randomised, 24 week double-blind, placebo-controlled studies in patients with active ankylosing spondylitis (mean baseline score of disease activity [Bath Ankylosing Spondylitis Disease Activity Index (BASDAI)] was 6.3 in all groups) who have had an inadequate response to conventional therapy. Seventy-nine (20.1 %) patients were treated concomitantly with disease modifying anti-rheumatic drugs, and 37 (9.4 %) patients with glucocorticoids. The blinded period was followed by an open-label period during which patients received adalimumab 40 mg every other week subcutaneously for up to an additional 28 weeks. Subjects ($n = 215$, 54.7 %) who failed to achieve ASAS 20 at Weeks 12, or 16 or 20 received early escape open-label adalimumab 40 mg every other week subcutaneously and were subsequently treated as non-responders in the double-blind statistical analyses.

In the larger AS study I with 315 patients, results showed statistically significant improvement of the signs and symptoms of ankylosing spondylitis in patients treated with adalimumab compared to placebo. Significant response was first observed at Week 2 and maintained through 24 weeks (Table 12).

**Table 12. Efficacy responses in placebo-controlled AS study – study I
reduction of signs and symptoms**

response	placebo N=107	adalimumab N=208
ASAS ^a 20		
Week 2	16 %	42 % ^{***}
Week 12	21 %	58 % ^{***}
Week 24	19 %	51 % ^{***}
ASAS 50		
Week 2	3 %	16 % ^{***}
Week 12	10 %	38 % ^{***}
Week 24	11 %	35 % ^{***}
ASAS 70		
Week 2	0 %	7 % ^{**}
Week 12	5 %	23 % ^{***}
Week 24	8 %	24 % ^{***}
BASDAI ^b 50		
Week 2	4 %	20 % ^{***}
Week 12	16 %	45 % ^{***}
Week 24	15 %	42 % ^{***}

^{***}, ^{**} statistically significant at $p < 0.001$, < 0.01 for all comparisons between adalimumab and placebo at Weeks 2, 12 and 24

^a assessments in ankylosing spondylitis

^b Bath ankylosing spondylitis disease activity index

Adalimumab-treated patients had significantly greater improvement at Week 12 which was maintained through Week 24 in both the SF36 and Ankylosing Spondylitis Quality of Life Questionnaire (ASQoL).

Similar trends (not all statistically significant) were seen in the smaller randomised, double-blind, placebo-controlled AS study II of 82 adult patients with active ankylosing spondylitis.

Axial spondyloarthritis without radiographic evidence of AS

The safety and efficacy of adalimumab were assessed in two randomized, double-blind placebo-controlled studies in patients with non-radiographic axial spondyloarthritis (nr-axSpA). Study nr-axSpA I evaluated patients with active nr-axSpA. Study nr-axSpA II was a treatment withdrawal study in active nr-axSpA patients who achieved remission during open-label treatment with adalimumab.

Study nr-axSpA I

In study nr-axSpA I, adalimumab 40 mg every other week was assessed in 185 patients in a randomised, 12 week double-blind, placebo-controlled study in patients with active nr-axSpA (mean baseline score of disease activity [Bath Ankylosing Spondylitis Disease Activity Index (BASDAI)] was 6.4 for patients treated with adalimumab and 6.5 for those on placebo) who have had an inadequate response to or intolerance to ≥ 1 NSAIDs, or a contraindication for NSAIDs.

Thirty-three (18 %) patients were treated concomitantly with disease modifying anti-rheumatic drugs, and 146 (79 %) patients with NSAIDs at baseline. The double-blind period was followed by an open-label period during which patients receive adalimumab 40 mg every other week subcutaneously for up

to an additional 144 weeks. Week 12 results showed statistically significant improvement of the signs and symptoms of active nr-axSpA in patients treated with adalimumab compared to placebo (Table 13).

Table 13. Efficacy response in placebo-controlled study nr-axSpA I

double-blind response at Week 12	placebo N=94	adalimumab N=91
ASAS ^a 40	15 %	36 %***
ASAS 20	31 %	52 %**
ASAS 5/6	6 %	31 %***
ASAS partial remission	5 %	16 %*
BASDAI ^b 50	15 %	35 %**
ASDAS ^{c,d,e}	-0.3	-1.0***
ASDAS inactive disease	4 %	24 %***
hs-CRP ^{d,f,g}	-0.3	-4.7***
SPARCC ^h MRI sacroiliac joints ^{d,i}	-0.6	-3.2**
SPARCC MRI spine ^{d,j}	-0.2	-1.8**

^a assessment of SpondyloArthritis International Society

^b Bath ankylosing spondylitis disease activity index

^c ankylosing spondylitis disease activity score

^d mean change from baseline

^e n=91 placebo and n=87 adalimumab

^f high sensitivity C-Reactive Protein (mg/L)

^g n=73 placebo and n=70 adalimumab

^h Spondyloarthritis Research Consortium of Canada

ⁱ n=84 placebo and adalimumab

^j n=82 placebo and n=85 adalimumab

***, **, * statistically significant at $p < 0.001$, < 0.01 , and < 0.05 , respectively, for all comparisons between adalimumab and placebo.

In the open-label extension, improvement in the signs and symptoms was maintained with adalimumab therapy through Week 156.

Inhibition of inflammation

Significant improvement of signs of inflammation as measured by hs-CRP and MRI of both Sacroiliac Joints and the Spine was maintained in adalimumab-treated patients through Week 156 and Week 104, respectively.

Quality of life and physical function

Health-related quality of life and physical function were assessed using the HAQ-S and the SF-36 questionnaires. Adalimumab showed statistically significantly greater improvement in the HAQ-S total score and the SF-36 Physical Component Score (PCS) from baseline to Week 12 compared to placebo. Improvement in health-related quality of life and physical function was maintained during the open-label extension through Week 156.

Study nr-axSpA II

673 patients with active nr-axSpA (mean baseline disease activity [BASDAI] was 7.0) who had an inadequate response to ≥ 2 NSAIDs, or an intolerance to or a contraindication for NSAIDs enrolled into the open-label period of Study nr-axSpA II during which they received adalimumab 40 mg eow for 28 weeks. These patients also had objective evidence of inflammation in the sacroiliac joints or

spine on MRI or elevated hs-CRP. Patients who achieved sustained remission for at least 12 weeks (N=305) (ASDAS < 1.3 at Weeks 16, 20, 24, and 28) during the open-label period were then randomized to receive either continued treatment with adalimumab 40 mg eow (N=152) or placebo (N=153) for an additional 40 weeks in a double-blind, placebo-controlled period (total study duration 68 weeks). Subjects who flared during the double-blind period were allowed adalimumab 40 mg eow rescue therapy for at least 12 weeks.

The primary efficacy endpoint was the proportion of patients with no flare by Week 68 of the study. Flare was defined as ASDAS \geq 2.1 at two consecutive visits four weeks apart. A greater proportion of patients on adalimumab had no disease flare during the double-blind period, when compared with those on placebo (70.4 % vs. 47.1 %, $p < 0.001$) (Figure 1).

Figure 1: Kaplan-Meier Curves summarizing time to flare in study nr-axSpA II

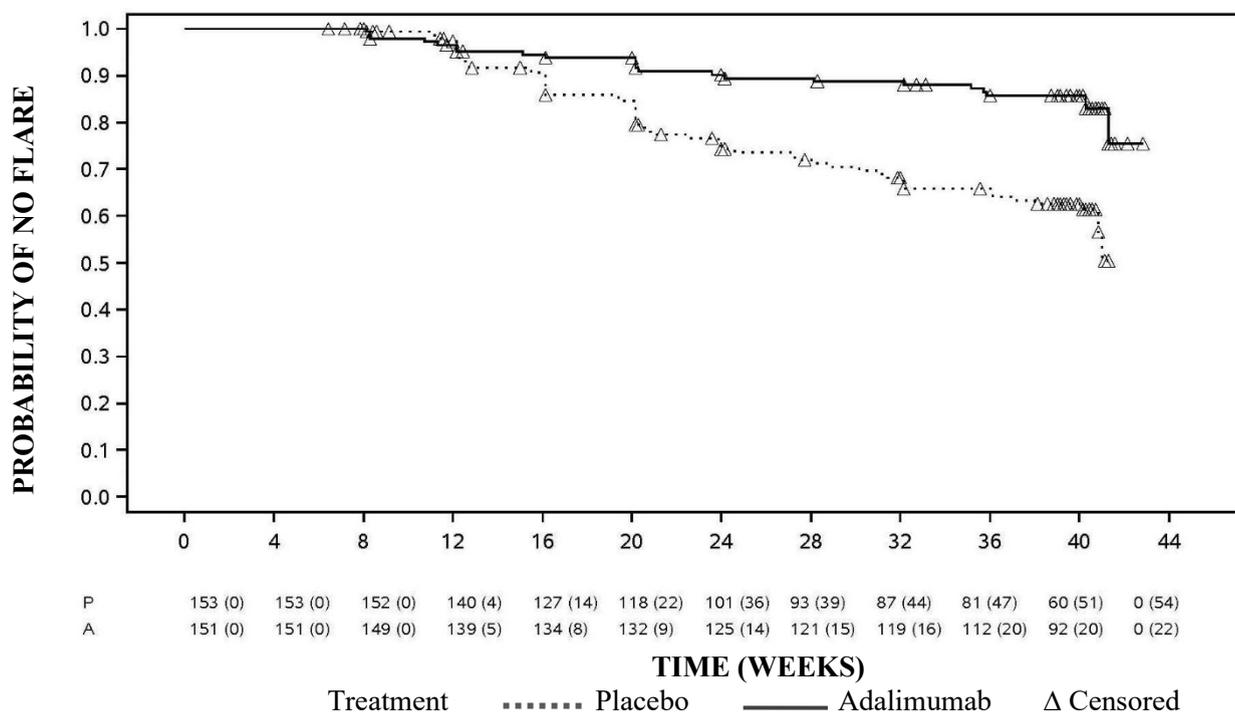

Note: P = Placebo (Number at Risk (flared)); A = Adalimumab (Number at Risk (flared)).

Among the 68 patients who flared in the group allocated to treatment withdrawal, 65 completed 12 weeks of rescue therapy with adalimumab, out of which 37 (56.9 %) had regained remission (ASDAS < 1.3) after 12 weeks of restarting the open-label treatment.

By Week 68, patients receiving continuous adalimumab treatment showed statistically significant greater improvement of the signs and symptoms of active nr-axSpA as compared to patients allocated to treatment withdrawal during the double-blind period of the study (Table 14).

Table 14. Efficacy response in placebo-controlled period for study nr-axSpA II

double-blind response at Week 68	placebo N=153	adalimumab N=152
ASAS ^{a,b} 20	47.1 %	70.4 % ^{***}
ASAS ^{a,b} 40	45.8 %	65.8 % ^{***}
ASAS ^a partial remission	26.8 %	42.1 % ^{**}
ASDAS ^c inactive disease	33.3 %	57.2 % ^{***}
partial flare ^d	64.1 %	40.8 % ^{***}

^a assessment of SpondyloArthritis International Society

^b baseline is defined as open label baseline when patients have active disease.

^c Ankylosing Spondylitis Disease Activity Score

^d partial flare is defined as ASDAS \geq 1.3 but $<$ 2.1 at 2 consecutive visits.

^{***}, ^{**} statistically significant at $p < 0.001$ and < 0.01 , respectively, for all comparisons between adalimumab and placebo.

Psoriatic arthritis

Adalimumab, 40 mg every other week, was studied in patients with moderately to severely active psoriatic arthritis in two placebo-controlled studies, PsA studies I and II. PsA study I with 24 week duration, treated 313 adult patients who had an inadequate response to non-steroidal anti-inflammatory drug therapy and of these, approximately 50 % were taking methotrexate. PsA study II with 12-week duration, treated 100 patients who had an inadequate response to DMARD therapy. Upon completion of both studies, 383 patients enrolled in an open-label extension study, in which 40 mg adalimumab was administered every other week (eow).

There is insufficient evidence of the efficacy of adalimumab in patients with ankylosing spondylitis-like psoriatic arthropathy due to the small number of patients studied.

Table 15. ACR response in placebo-controlled psoriatic arthritis studies (percent of patients)

response	PsA study I		PsA study II	
	placebo N=162	adalimumab N=151	placebo N=49	adalimumab N=51
ACR 20				
Week 12	14 %	58 % ^{***}	16 %	39 % [*]
Week 24	15 %	57 % ^{***}	N/A	N/A
ACR 50				
Week 12	4 %	36 % ^{***}	2 %	25 % ^{***}
Week 24	6 %	39 % ^{***}	N/A	N/A
ACR 70				
Week 12	1 %	20 % ^{***}	0 %	14 % [*]
Week 24	1 %	23 % ^{***}	N/A	N/A

^{***} $p < 0.001$ for all comparisons between adalimumab and placebo

^{*} $p < 0.05$ for all comparisons between adalimumab and placebo

N/A not applicable

ACR responses in PsA study I were similar with and without concomitant methotrexate therapy. ACR responses were maintained in the open-label extension study for up to 136 weeks.

Radiographic changes were assessed in the psoriatic arthritis studies. Radiographs of hands, wrists, and feet were obtained at baseline and Week 24 during the double-blind period when patients were on adalimumab or placebo and at Week 48 when all patients were on open-label adalimumab. A modified Total Sharp Score (mTSS), which included distal interphalangeal joints (i.e. not identical to the TSS used for rheumatoid arthritis), was used.

Adalimumab treatment reduced the rate of progression of peripheral joint damage compared with placebo treatment as measured by change from baseline in mTSS (mean \pm SD) 0.8 ± 2.5 in the placebo group (at Week 24) compared with 0.0 ± 1.9 ; ($p < 0.001$) in the adalimumab group (at Week 48).

In subjects treated with adalimumab with no radiographic progression from baseline to Week 48 ($n=102$), 84 % continued to show no radiographic progression through 144 weeks of treatment. Adalimumab-treated patients demonstrated statistically significant improvement in physical function as assessed by HAQ and Short Form Health Survey (SF 36) compared to placebo at Week 24. Improved physical function continued during the open label extension up to Week 136.

Psoriasis

The safety and efficacy of adalimumab were studied in adult patients with chronic plaque psoriasis (≥ 10 % BSA involvement and Psoriasis Area and Severity Index (PASI) ≥ 12 or ≥ 10) who were candidates for systemic therapy or phototherapy in randomised, double-blind studies. 73 % of patients enrolled in Psoriasis Studies I and II had received prior systemic therapy or phototherapy. The safety and efficacy of adalimumab were also studied in adult patients with moderate to severe chronic plaque psoriasis with concomitant hand and/or foot psoriasis who were candidates for systemic therapy in a randomised double-blind study (Psoriasis Study III).

Psoriasis Study I (REVEAL) evaluated 1 212 patients within three treatment periods. In period A, patients received placebo or adalimumab at an initial dose of 80 mg followed by 40 mg every other week starting one week after the initial dose. After 16 weeks of therapy, patients who achieved at least a PASI 75 response (PASI score improvement of at least 75 % relative to baseline), entered period B and received open-label 40 mg adalimumab every other week. Patients who maintained \geq PASI 75 response at Week 33 and were originally randomised to active therapy in period A, were re-randomised in period C to receive 40 mg adalimumab every other week or placebo for an additional 19 weeks. Across all treatment groups, the mean baseline PASI score was 18.9 and the baseline Physician's Global Assessment (PGA) score ranged from "moderate" (53 % of subjects included) to "severe" (41 %) to "very severe" (6 %).

Psoriasis Study II (CHAMPION) compared the efficacy and safety of adalimumab *versus* methotrexate and placebo in 271 patients. Patients received placebo, an initial dose of MTX 7.5 mg and thereafter dose increases up to Week 12, with a maximum dose of 25 mg or an initial dose of 80 mg adalimumab followed by 40 mg every other week (starting one week after the initial dose) for 16 weeks. There are no data available comparing adalimumab and MTX beyond 16 weeks of therapy. Patients receiving MTX who achieved a \geq PASI 50 response at Week 8 and/or 12 did not receive further dose increases. Across all treatment groups, the mean baseline PASI score was 19.7 and the baseline PGA score ranged from "mild" (< 1 %) to "moderate" (48 %) to "severe" (46 %) to "very severe" (6 %).

Patients participating in all Phase 2 and Phase 3 psoriasis studies were eligible to enrol into an open-label extension study, where adalimumab was given for at least an additional 108 weeks.

In Psoriasis Studies I and II, a primary endpoint was the proportion of patients who achieved a PASI 75 response from baseline at Week 16 (see Tables 16 and 17).

Table 16. Ps study I (REVEAL) – efficacy results at 16 weeks

	placebo N = 398 n (%)	adalimumab 40 mg eow N = 814 n (%)
≥PASI 75 ^a	26 (6.5)	578 (70.9) ^b
PASI 100	3 (0.8)	163 (20.0) ^b
PGA: clear/minimal	17 (4.3)	506 (62.2) ^b

^a percent of patients achieving PASI75 response was calculated as centre-adjusted rate

^b p<0.001, adalimumab vs. placebo

Table 17. Ps study II (CHAMPION) efficacy results at 16 weeks

	placebo N = 53 n (%)	MTX N = 110 n (%)	adalimumab 40 mg eow N=108 n (%)
≥PASI 75	10 (18.9)	39 (35.5)	86 (79.6) ^{a, b}
PASI 100	1 (1.9)	8 (7.3)	18 (16.7) ^{c, d}
PGA: clear/minimal	6 (11.3)	33 (30.0)	79 (73.1) ^{a, b}

^a p<0.001 adalimumab vs. placebo

^b p<0.001 adalimumab vs. methotrexate

^c p<0.01 adalimumab vs. placebo

^d p<0.05 adalimumab vs. methotrexate

In Psoriasis Study I, 28 % of patients who were PASI 75 responders and were re-randomised to placebo at Week 33 compared to 5 % continuing on adalimumab, p < 0.001, experienced “loss of adequate response” (PASI score after Week 33 and on or before Week 52 that resulted in a < PASI 50 response relative to baseline with a minimum of a 6-point increase in PASI score relative to Week 33). Of the patients who lost adequate response after re-randomisation to placebo who then enrolled into the open-label extension study, 38 % (25/66) and 55 % (36/66) regained PASI 75 response after 12 and 24 weeks of re-treatment, respectively.

A total of 233 PASI 75 responders at Week 16 and Week 33 received continuous adalimumab therapy for 52 weeks in Psoriasis Study I, and continued adalimumab in the open-label extension study. PASI 75 and PGA of clear or minimal response rates in these patients were 74.7 % and 59.0 %, respectively, after an additional 108 weeks of open-label therapy (total of 160 weeks). In an analysis in which all patients who dropped out of the study for adverse events or lack of efficacy, or who dose-escalated, were considered non-responders, PASI 75 and PGA of clear or minimal response rates in these patients were 69.6 % and 55.7 %, respectively, after an additional 108 weeks of open-label therapy (total of 160 weeks).

A total of 347 stable responders participated in a withdrawal and retreatment evaluation in an open-label extension study. During the withdrawal period, symptoms of psoriasis returned over time with a median time to relapse (decline to PGA “moderate” or worse) of approximately 5 months. None of these patients experienced rebound during the withdrawal period. A total of 76.5 % (218/285) of patients who entered the retreatment period had a response of PGA “clear” or “minimal” after 16 weeks of retreatment, irrespective of whether they relapsed during withdrawal (69.1 % [123/178] and 88.8 % [95/107] for patients who relapsed and who did not relapse during the withdrawal period, respectively). A similar safety profile was observed during retreatment as before withdrawal. Significant improvements at Week 16 from baseline compared to placebo (Studies I and II) and MTX (Study II) were demonstrated in the DLQI (Dermatology Life Quality Index). In Study I, improvements in the physical and mental component summary scores of the SF-36 were also

significant compared to placebo.

In an open-label extension study, for patients who dose escalated from 40 mg every other week to 40 mg weekly due to a PASI response below 50 %, 26.4 % (92/349) and 37.8 % (132/349) of patients achieved PASI 75 response at Week 12 and 24, respectively.

Psoriasis Study III (REACH) compared the efficacy and safety of adalimumab *versus* placebo in 72 patients with moderate to severe chronic plaque psoriasis and hand and/or foot psoriasis. Patients received an initial dose of 80 mg adalimumab followed by 40 mg every other week (starting one week after the initial dose) or placebo for 16 weeks. At Week 16, a statistically significantly greater proportion of patients who received adalimumab achieved PGA of 'clear' or 'almost clear' for the hands and/or feet compared to patients who received placebo (30.6% versus 4.3 %, respectively [P = 0.014]).

Psoriasis Study IV compared efficacy and safety of adalimumab versus placebo in 217 adult patients with moderate to severe nail psoriasis. Patients received an initial dose of 80 mg adalimumab followed by 40 mg every other week (starting one week after the initial dose) or placebo for 26 weeks followed by open-label adalimumab treatment for an additional 26 weeks. Nail psoriasis assessments included the Modified Nail Psoriasis Severity Index (mNAPSI), the Physician's Global Assessment of Fingernail Psoriasis (PGA-F) and the Nail Psoriasis Severity Index (NAPSI) (see Table 18). Adalimumab demonstrated a treatment benefit in nail psoriasis patients with different extents of skin involvement (BSA \geq 10 % (60 % of patients) and BSA < 10 % and \geq 5 % (40 % of patients)).

Table 18. Ps study IV efficacy results at 16, 26 and 52 weeks

endpoint	Week 16 placebo-controlled		Week 26 placebo-controlled		Week 52 open-label
	placebo N = 108	adalimumab 40 mg eow N = 109	placebo N = 108	adalimumab 40 mg eow N = 109	adalimumab 40 mg eow N = 80
\geq mNAPSI 75 (%)	2.9	26.0 ^a	3.4	46.6 ^a	65.0
PGA-F clear/minimal and \geq 2-grade improvement (%)	2.9	29.7 ^a	6.9	48.9 ^a	61.3
percent change in total fingernail NAPSI (%)	-7.8	-44.2 ^a	-11.5	-56.2 ^a	-72.2

^a p < 0.001, adalimumab vs. placebo

Adalimumab-treated patients showed statistically significant improvements at Week 26 compared with placebo in the DLQI.

Hidradenitis suppurativa

The safety and efficacy of adalimumab were assessed in randomised, double-blind, placebo-controlled studies and an open-label extension study in adult patients with moderate to severe hidradenitis suppurativa (HS) who were intolerant, had a contraindication or an inadequate response to at least a 3-month study of systemic antibiotic therapy. The patients in HS-I and HS-II had Hurley Stage II or III disease with at least 3 abscesses or inflammatory nodules.

Study HS-I (PIONEER I) evaluated 307 patients with 2 treatment periods. In period A, patients received placebo or adalimumab at an initial dose of 160 mg at Week 0, 80 mg at Week 2, and 40 mg every week starting at Week 4 to Week 11. Concomitant antibiotic use was not allowed during the study. After 12 weeks of therapy, patients who had received adalimumab in period A were re-randomised in period B to 1 of 3 treatment groups (adalimumab 40 mg every week, adalimumab

40 mg every other week, or placebo from Week 12 to Week 35). Patients who had been randomised to placebo in period A were assigned to receive adalimumab 40 mg every week in period B.

Study HS-II (PIONEER II) evaluated 326 patients with 2 treatment periods. In period A, patients received placebo or adalimumab at an initial dose of 160 mg at Week 0 and 80 mg at Week 2 and 40 mg every week starting at Week 4 to Week 11. 19.3 % of patients had continued baseline oral antibiotic therapy during the study. After 12 weeks of therapy, patients who had received adalimumab in period A were re-randomised in period B to 1 of 3 treatment groups (adalimumab 40 mg every week, adalimumab 40 mg every other week, or placebo from Week 12 to Week 35). Patients who had been randomised to placebo in period A were assigned to receive placebo in period B.

Patients participating in Studies HS-I and HS-II were eligible to enrol into an open-label extension study in which adalimumab 40 mg was administered every week. Mean exposure in all adalimumab population was 762 days. Throughout all 3 studies patients used topical antiseptic wash daily.

Clinical response

Reduction of inflammatory lesions and prevention of worsening of abscesses and draining fistulas was assessed using Hidradenitis Suppurativa Clinical Response (HiSCR; at least a 50 % reduction in total abscess and inflammatory nodule count with no increase in abscess count and no increase in draining fistula count relative to Baseline). Reduction in HS-related skin pain was assessed using a Numeric Rating Scale in patients who entered the study with an initial baseline score of 3 or greater on a 11 point scale.

At Week 12, a significantly higher proportion of patients treated with adalimumab versus placebo achieved HiSCR. At Week 12, a significantly higher proportion of patients in Study HS-II experienced a clinically relevant decrease in HS-related skin pain (see Table 19). Patients treated with adalimumab had significantly reduced risk of disease flare during the initial 12 weeks of treatment.

Table 19. Efficacy results at 12 weeks, HS studies I and II

	HS study I		HS study II	
	placebo	adalimumab 40 mg weekly	placebo	adalimumab 40 mg weekly
hidradenitis suppurativa clinical response (HiSCR) ^a	N = 154 40 (26.0 %)	N = 153 64 (41.8 %)*	N = 163 45 (27.6 %)	N = 163 96 (58.9 %)**
≥30% reduction in skin pain ^b	N = 109 27 (24.8 %)	N = 122 34 (27.9 %)	N = 111 23 (20.7 %)	N = 105 48 (45.7 %)**

* $p < 0.05$,

** $p < 0.001$, adalimumab versus placebo

^a among all randomised patients.

^b among patients with baseline HS-related skin pain assessment ≥ 3 , based on Numeric Rating Scale 0–10; 0 = no skin pain, 10 = skin pain as bad as you can imagine.

Treatment with adalimumab 40 mg every week significantly reduced the risk of worsening of abscesses and draining fistulas. Approximately twice the proportion of patients in the placebo group in the first 12 weeks of Studies HS-I and HS-II, compared with those in the adalimumab group experienced worsening of abscesses (23.0 % vs 11.4 %, respectively) and draining fistulas (30.0 % vs 13.9 %, respectively).

Greater improvements at Week 12 from baseline compared to placebo were demonstrated in skin-specific health-related quality of life, as measured by the Dermatology Life Quality Index (DLQI; Studies HS-I and HS-II), patient global satisfaction with medicinal product treatment as measured by the Treatment Satisfaction Questionnaire – medication (TSQM; Studies HS-I and HS-II), and physical health as measured by the physical component summary score of the SF-36 (Study HS-I).

In patients with at least a partial response to adalimumab 40 mg weekly at Week 12, the HiSCR rate at Week 36 was higher in patients who continued weekly adalimumab than in patients in whom dosing frequency was reduced to every other week, or in whom treatment was withdrawn (see Table 20).

Table 20. Proportion of patients^a achieving HiSCR^b at Weeks 24 and 36 after treatment reassignment from weekly adalimumab at Week 12

	placebo (treatment withdrawal) N = 73	adalimumab 40 mg every other week N = 70	adalimumab 40 mg weekly N = 70
Week 24	24 (32.9 %)	36 (51.4 %)	40 (57.1 %)
Week 36	22 (30.1 %)	28 (40.0 %)	39 (55.7 %)

^a patients with at least a partial response to adalimumab 40 mg weekly after 12 weeks of treatment.

^b patients meeting protocol-specified criteria for loss of response or no improvement were required to discontinue from the studies and were counted as non-responders.

Among patients who were at least partial responders at Week 12, and who received continuous weekly adalimumab therapy, the HiSCR rate at Week 48 was 68.3 % and at Week 96 was 65.1 %. Longer term treatment with adalimumab 40 mg weekly for 96 weeks identified no new safety findings.

Among patients whose adalimumab treatment was withdrawn at Week 12 in Studies HS-I and HS-II, the HiSCR rate 12 weeks after re-introduction of adalimumab 40 mg weekly returned to levels similar to that observed before withdrawal (56.0 %).

Crohn's disease

The safety and efficacy of adalimumab were assessed in over 1 500 patients with moderately to severely active Crohn's disease (Crohn's Disease Activity Index (CDAI) ≥ 220 and ≤ 450) in randomised, double-blind, placebo-controlled studies. Concomitant stable doses of aminosalicylates, corticosteroids, and/or immunomodulatory agents were permitted and 80 % of patients continued to receive at least one of these medicinal products.

Induction of clinical remission (defined as CDAI < 150) was evaluated in two studies, CD Study I (CLASSIC I) and CD Study II (GAIN). In CD Study I, 299 TNF-antagonist naïve patients were randomised to one of four treatment groups; placebo at Weeks 0 and 2, 160 mg adalimumab at Week 0 and 80 mg at Week 2, 80 mg at Week 0 and 40 mg at Week 2, and 40 mg at Week 0 and 20 mg at Week 2. In CD Study II, 325 patients who had lost response or were intolerant to infliximab were randomised to receive either 160 mg adalimumab at Week 0 and 80 mg at Week 2 or placebo at Weeks 0 and 2. The primary non-responders were excluded from the studies and therefore these patients were not further evaluated.

Maintenance of clinical remission was evaluated in CD study III (CHARM). In CD study III, 854 patients received open-label 80 mg at Week 0 and 40 mg at Week 2. At Week 4 patients were randomised to 40 mg every other week, 40 mg every week, or placebo with a total study duration of 56 weeks. Patients in clinical response (decrease in CDAI \geq 70) at Week 4 were stratified and analysed separately from those not in clinical response at Week 4. Corticosteroid taper was permitted after Week 8.

CD study I and CD study II induction of remission and response rates are presented in Table 21.

**Table 21. Induction of clinical remission and response
(percent of patients)**

	CD study I: infliximab-naïve patients			CD study II: infliximab-experienced patients	
	placebo N = 74	adalimumab 80/40 mg N = 75	adalimumab 160/80 mg N = 76	placebo N=166	adalimumab 160/80 mg N = 159
Week 4					
clinical remission	12 %	24 %	36 %*	7 %	21 %*
clinical response (CR-100)	24 %	37 %	49 %**	25 %	38 %**

All p-values are pairwise comparisons of proportions for adalimumab *versus* placebo

* p < 0.001

** p < 0.01

Similar remission rates were observed for the 160/80 mg and 80/40 mg induction regimens by Week 8 and adverse events were more frequently noted in the 160/80 mg group.

In CD study III, at Week 4, 58 % (499/854) of patients were in clinical response and were assessed in the primary analysis. Of those in clinical response at Week 4, 48 % had been previously exposed to other TNF-antagonists. Maintenance of remission and response rates are presented in Table 22. Clinical remission results remained relatively constant irrespective of previous TNF-antagonist exposure. Disease-related hospitalisations and surgeries were statistically significantly reduced with adalimumab compared with placebo at Week 56.

**Table 22. Maintenance of clinical remission and response
(percent of patients)**

	placebo	40 mg adalimumab every other week	40 mg adalimumab every week
Week 26	N = 170	N = 172	N = 157
clinical remission	17 %	40 %*	47 %*
clinical response (CR-100)	27 %	52 %*	52 %*
patients in steroid-free remission for ≥ 90 days ^a	3 % (2/66)	19 % (11/58)**	15 % (11/74)**
Week 56	N = 170	N = 172	N = 157
clinical remission	12 %	36 %*	41 %*
clinical response (CR-100)	17 %	41 %*	48 %*
patients in steroid-free remission for ≥ 90 days ^a	5 % (3/66)	29 % (17/58)*	20 % (15/74)**

* $p < 0.001$ for adalimumab *versus* placebo pairwise comparisons of proportions

** $p < 0.02$ for adalimumab *versus* placebo pairwise comparisons of proportions

^a of those receiving corticosteroids at baseline

Among patients who were not in response at Week 4, 43 % of adalimumab maintenance patients responded by Week 12 compared to 30 % of placebo maintenance patients. These results suggest that some patients who have not responded by Week 4 benefit from continued maintenance therapy through Week 12. Therapy continued beyond 12 weeks did not result in significantly more responses (see section 4.2).

117/276 patients from CD study I and 272/777 patients from CD studies II and III were followed through at least 3 years of open-label adalimumab therapy. 88 and 189 patients, respectively, continued to be in clinical remission. Clinical response (CR-100) was maintained in 102 and 233 patients, respectively.

Quality of life

In CD study I and CD study II, statistically significant improvement in the disease-specific inflammatory bowel disease questionnaire (IBDQ) total score was achieved at Week 4 in patients randomised to adalimumab 80/40 mg and 160/80 mg compared to placebo and was seen at Weeks 26 and 56 in CD study III as well among the adalimumab treatment groups compared to the placebo group.

Ulcerative colitis

The safety and efficacy of multiple doses of adalimumab were assessed in adult patients with moderately to severely active ulcerative colitis (Mayo score 6 to 12 with endoscopy subscore of 2 to 3) in randomised, double-blind, placebo-controlled studies.

In study UC-I, 390 TNF-antagonist naïve patients were randomised to receive either placebo at Weeks 0 and 2, 160 mg adalimumab at Week 0 followed by 80 mg at Week 2, or 80 mg adalimumab at Week 0 followed by 40 mg at Week 2. After Week 2, patients in both adalimumab arms received 40 mg eow. Clinical remission (defined as Mayo score ≤ 2 with no subscore > 1) was assessed at Week 8.

In study UC-II, 248 patients received 160 mg of adalimumab at Week 0, 80 mg at Week 2 and 40 mg

erow thereafter, and 246 patients received placebo. Clinical results were assessed for induction of remission at Week 8 and for maintenance of remission at Week 52.

Patients induced with 160/80 mg adalimumab achieved clinical remission versus placebo at Week 8 in statistically significantly greater percentages in study UC-I (18 % vs. 9 % respectively, $p = 0.031$) and study UC-II (17 % vs. 9 % respectively, $p = 0.019$). In study UC-II, among those treated with adalimumab who were in remission at Week 8, 21/41 (51 %) were in remission at Week 52.

Results from the overall UC-II study population are shown in Table 23.

Table 23. Response, remission and mucosal healing in study UC-II (percent of patients)

	placebo	adalimumab 40 mg erow
Week 52	N = 246	N = 248
clinical response	18 %	30 %*
clinical remission	9 %	17 %*
mucosal healing	15 %	25 %*
steroid-free remission for ≥ 90 days ^a	6 %	13 %*
	(N = 140)	(N = 150)
Week 8 and 52		
sustained response	12 %	24 %**
sustained remission	4 %	8 %*
sustained mucosal healing	11 %	19 %*

clinical remission is Mayo score ≤ 2 with no subscore > 1 ;

clinical response is decrease from baseline in Mayo score ≥ 3 points and ≥ 30 % plus a decrease in the rectal bleeding subscore [RBS] ≥ 1 or an absolute RBS of 0 or 1;

* $p < 0.05$ for adalimumab vs. placebo pairwise comparison of proportions

** $p < 0.001$ for adalimumab vs. placebo pairwise comparison of proportions

^a of those receiving corticosteroids at baseline

Of those patients who had a response at Week 8, 47 % were in response, 29 % were in remission, 41 % had mucosal healing, and 20 % were in steroid-free remission for ≥ 90 days at Week 52.

Approximately 40 % of patients in study UC-II had failed prior anti-TNF treatment with infliximab. The efficacy of adalimumab in those patients was reduced compared to that in anti-TNF naïve patients. Among patients who had failed prior anti-TNF treatment, Week 52 remission was achieved by 3 % on placebo and 10 % on adalimumab.

Patients from studies UC-I and UC-II had the option to roll over into an open-label long-term extension study (UC III). Following 3 years of adalimumab therapy, 75 % (301/402) continued to be in clinical remission per partial Mayo score.

Hospitalisation rates

During 52 weeks of studies UC-I and UC-II, lower rates of all-cause hospitalisations and UC-related hospitalisations were observed for the adalimumab-treated arm compared to the placebo arm. The number of all cause hospitalisations in the adalimumab treatment group was 0.18 per patient year vs. 0.26 per patient year in the placebo group and the corresponding figures for UC-related hospitalisations were 0.12 per patient year vs. 0.22 per patient year.

Quality of life

In study UC-II, treatment with adalimumab resulted in improvements in the Inflammatory Bowel Disease Questionnaire (IBDQ) score.

Uveitis

The safety and efficacy of adalimumab were assessed in adult patients with non-infectious intermediate, posterior, and panuveitis, excluding patients with isolated anterior uveitis, in two randomised, double-masked, placebo-controlled studies (UV I and II). Patients received placebo or adalimumab at an initial dose of 80 mg followed by 40 mg every other week starting one week after the initial dose. Concomitant stable doses of one non-biologic immunosuppressant were permitted.

Study UV I evaluated 217 patients with active uveitis despite treatment with corticosteroids (oral prednisone at a dose of 10 to 60 mg/day). All patients received a 2-week standardised dose of prednisone 60 mg/day at study entry followed by a mandatory taper schedule, with complete corticosteroid discontinuation by Week 15.

Study UV II evaluated 226 patients with inactive uveitis requiring chronic corticosteroid treatment (oral prednisone 10 to 35 mg/day) at baseline to control their disease. Patients subsequently underwent a mandatory taper schedule, with complete corticosteroid discontinuation by Week 19.

The primary efficacy endpoint in both studies was ‘time to treatment failure’. Treatment failure was defined by a multi-component outcome based on inflammatory chorioretinal and/or inflammatory retinal vascular lesions, anterior chamber (AC) cell grade, vitreous haze (VH) grade and best corrected visual acuity (BCVA).

Patients who completed studies UV I and UV II were eligible to enroll in an uncontrolled long-term extension study with an originally planned duration of 78 weeks. Patients were allowed to continue on study medicinal product beyond Week 78 until they had access to adalimumab.

Clinical response

Results from both studies demonstrated statistically significant reduction of the risk of treatment failure in patients treated with adalimumab versus patients receiving placebo (see Table 24). Both studies demonstrated an early and sustained effect of adalimumab on the treatment failure rate versus placebo (see Figure 2).

Table 24. Time to treatment failure in studies UV I and UV II

analysis treatment	N	failure N (%)	median time to failure (months)	HR^a	CI 95 % for HR^a	p Value^b
time to treatment failure at or after Week 6 in study UV I						
primary analysis (ITT)						
placebo	107	84 (78.5)	3.0	--	--	--
adalimumab	110	60 (54.5)	5.6	0.50	0.36, 0.70	< 0.001
time to treatment failure at or after Week 2 in study UV II						
primary analysis (ITT)						
placebo	111	61 (55.0)	8.3	--	--	--
adalimumab	115	45 (39.1)	NE ^c	0.57	0.39, 0.84	0.004

Note: treatment failure at or after Week 6 (study UV I), or at or after Week 2 (study UV II), was counted as event. Drop outs due to reasons other than treatment failure were censored at the time of dropping out.

^a HR of adalimumab vs placebo from proportional hazards regression with treatment as factor.

^b 2-sided *p* value from log rank test.

^c NE = not estimable. Fewer than half of at-risk subjects had an event.

Figure 2: Kaplan-Meier curves summarizing time to treatment failure on or after Week 6 (study UV I) or Week 2 (study UV II)

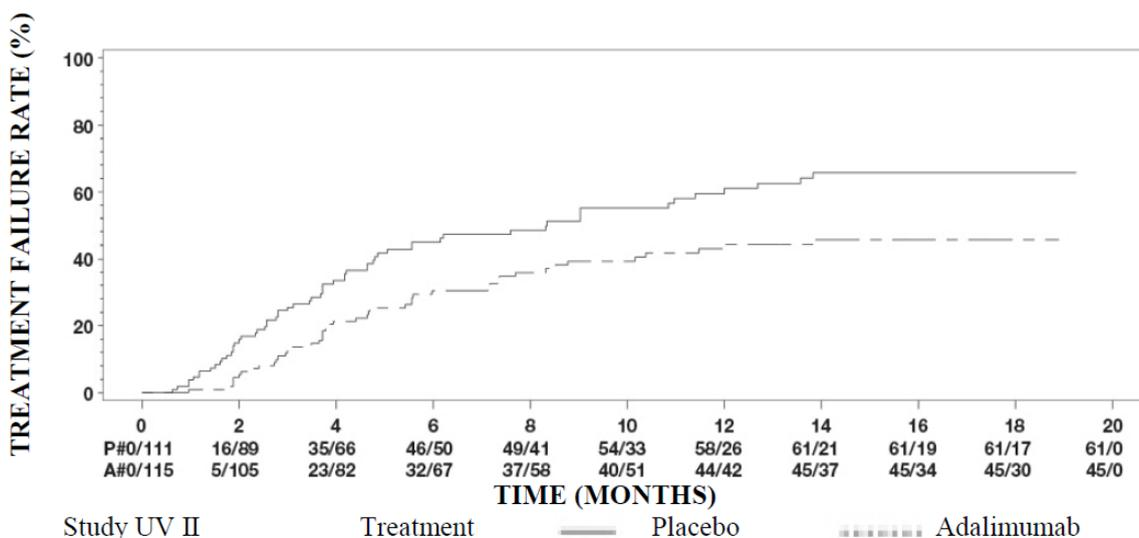
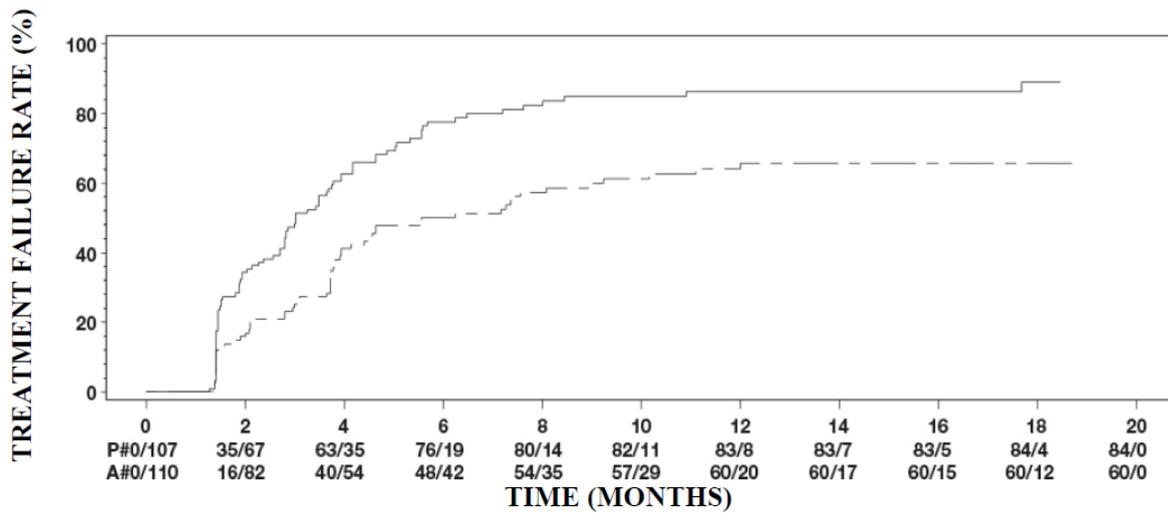

Note: P# = Placebo (Number of Events/Number at Risk); A# = Adalimumab (Number of Events/Number at Risk).

In Study UV I statistically significant differences in favour of adalimumab versus placebo were observed for each component of treatment failure. In Study UV II, statistically significant differences were observed for visual acuity only, but the other components were numerically in favour of adalimumab.

Of the 424 subjects included in the uncontrolled long-term extension of studies UV I and UV II, 60 subjects were regarded ineligible (e.g. due to deviations or due to complications secondary to diabetic retinopathy, due to cataract surgery or vitrectomy) and were excluded from the primary analysis of efficacy. Of the 364 remaining patients, 269 evaluable patients (74 %) reached 78 weeks of open-label adalimumab treatment. Based on the observed data approach, 216 (80.3 %) were in quiescence (no active inflammatory lesions, AC cell grade $\leq 0.5+$, VH grade $\leq 0.5+$) with a concomitant steroid dose ≤ 7.5 mg per day, and 178 (66.2 %) were in steroid-free quiescence. BCVA was either improved or maintained (< 5 letters deterioration) in 88.6 % of the eyes at Week 78. Data beyond Week 78 were generally consistent with these results but the number of enrolled subjects declined after this time. Overall, among the patients who discontinued the study, 18 % discontinued due

to adverse events, and 8 % due to insufficient response to adalimumab treatment.

Quality of Life

Patient reported outcomes regarding vision-related functioning were measured in both clinical studies, using the NEI VFQ-25. Adalimumab was numerically favoured for the majority of subscores with statistically significant mean differences for general vision, ocular pain, near vision, mental health, and total score in study UV I, and for general vision and mental health in study UV II. Vision related effects were not numerically in favour of adalimumab for colour vision in study UV I and for colour vision, peripheral vision and near vision in study UV II.

Immunogenicity

Anti-adalimumab antibodies may develop during adalimumab treatment. Formation of anti-adalimumab antibodies is associated with increased clearance and reduced efficacy of adalimumab. There is no apparent correlation between the presence of anti-adalimumab antibodies and the occurrence of adverse events.

Paediatric population

Juvenile idiopathic arthritis (JIA)

Polyarticular juvenile idiopathic arthritis (pJIA)

The safety and efficacy of adalimumab was assessed in two studies (pJIA I and II) in children with active polyarticular or polyarticular course juvenile idiopathic arthritis, who had a variety of JIA onset types (most frequently rheumatoid-factor negative or positive polyarthritis and extended oligoarthritis).

pJIA I

The safety and efficacy of adalimumab were assessed in a multicentre, randomised, double-blind, parallel-group study in 171 children (4–17 years old) with polyarticular JIA. In the open-label lead in phase (OL LI) patients were stratified into two groups, MTX (methotrexate)-treated or non-MTX-treated. Patients who were in the non-MTX stratum were either naïve to or had been withdrawn from MTX at least two weeks prior to study drug administration. Patients remained on stable doses of NSAIDs and or prednisone (≤ 0.2 mg/kg/day or 10 mg/day maximum). In the OL LI phase all patients received 24 mg/m² up to a maximum of 40 mg adalimumab every other week for 16 weeks. The distribution of patients by age and minimum, median and maximum dose received during the OL LI phase is presented in Table 25.

Table 25. Distribution of patients by age and adalimumab dose received during the OL LI phase

age group	number of patients at baseline n (%)	Minimum, median and maximum dose
4 to 7 years	31 (18.1)	10, 20 and 25 mg
8 to 12 years	71 (41.5)	20, 25 and 40 mg
13 to 17 years	69 (40.4)	25, 40 and 40 mg

Patients demonstrating a paediatric ACR 30 response at Week 16 were eligible to be randomised into the double blind (DB) phase and received either adalimumab 24 mg/m² up to a maximum of 40 mg, or placebo every other week for an additional 32 weeks or until disease flare. Disease flare criteria were defined as a worsening of ≥ 30 % from baseline in ≥ 3 of 6 paediatric ACR core criteria, ≥ 2 active joints, and improvement of > 30 % in no more than 1 of the 6 criteria. After 32 weeks or at disease flare, patients were eligible to enrol into the open label extension phase.

Table 26. Ped ACR 30 responses in the JIA study

stratum	MTX		without MTX	
phase				
OL-LI 16 weeks				
ped ACR 30 response (n/N)	94.1 % (80/85)		74.4% (64/86)	
efficacy outcomes				
double blind 32 weeks	adalimumab/M TX (N =38)	placebo/MTX (N = 37)	adalimumab (N = 30)	placebo (N = 28)
disease flares at the end of 32 weeks ^a (n/N)	36.8 % (14/38)	64.9 % (24/37) ^b	43.3 % (13/30)	71.4 % (20/28) ^c
median time to disease flare	>32 weeks	20 weeks	>32 weeks	14 weeks

^a ped ACR 30/50/70 responses Week 48 significantly greater than those of placebo-treated patients

^b p = 0.015

^c p = 0.031

Amongst those who responded at Week 16 (n = 144), the paediatric ACR 30/50/70/90 responses were maintained for up to six years in the OLE phase in patients who received adalimumab throughout the study. Over all 19 subjects, of which 11 of the baseline age group 4 to 12 and 8 of the baseline age group 13 to 17 years were treated 6 years or longer.

Overall responses were generally better and, fewer patients developed antibodies when treated with the combination of adalimumab and MTX compared to adalimumab alone. Taking these results into consideration, Hyrimoz is recommended for use in combination with MTX and for use as monotherapy in patients for whom MTX use is not appropriate (see section 4.2).

pJIA II

The safety and efficacy of adalimumab was assessed in an open-label, multicentre study in 32 children (2–< 4 years old or aged 4 and above weighing < 15 kg) with moderately to severely active polyarticular JIA. The patients received 24 mg/m² body surface area (BSA) of adalimumab up to a maximum of 20 mg every other week as a single dose via SC injection for at least 24 weeks. During the study, most subjects used concomitant MTX, with fewer reporting use of corticosteroids or NSAIDs.

At Week 12 and Week 24, PedACR30 response was 93.5 % and 90.0 %, respectively, using the observed data approach. The proportions of subjects with PedACR50/70/90 at Week 12 and Week 24 were 90.3 %/61.3 %/38.7 % and 83.3 %/73.3 %/36.7 %, respectively. Amongst those who responded (paediatric ACR 30) at Week 24 (n = 27 out of 30 patients), the paediatric ACR 30 responses were maintained for up to 60 weeks in the OLE phase in patients who received adalimumab throughout this time period. Overall, 20 subjects were treated for 60 weeks or longer.

Enthesitis-related arthritis

The safety and efficacy of adalimumab were assessed in a multicentre, randomised, double-blind study in 46 paediatric patients (6 to 17 years old) with moderate enthesitis-related arthritis. Patients were randomised to receive either 24 mg/m² body surface area (BSA) of adalimumab up to a maximum of 40 mg, or placebo every other week for 12 weeks. The double-blind period is followed by an open-label

(OL) period during which patients received 24 mg/m² BSA of adalimumab up to a maximum of 40 mg every other week subcutaneously for up to an additional 192 weeks. The primary endpoint was the percent change from Baseline to Week 12 in the number of active joints with arthritis (swelling not due to deformity or joints with loss of motion plus pain and/or tenderness), which was achieved with mean percent decrease of -62.6 % (median percent change -88.9 %) in patients in the adalimumab group compared to -11.6 % (median percent change -50.0 %) in patients in the placebo group. Improvement in number of active joints with arthritis was maintained during the OL period through Week 156 for the 26 of 31 (84 %) patients in the adalimumab group who remained in the study. Although not statistically significant, the majority of patients demonstrated clinical improvement in secondary endpoints such as number of sites of enthesitis, tender joint count (TJC), swollen joint count (SJC), paediatric ACR 50 response, and paediatric ACR 70 response.

Paediatric plaque psoriasis

The efficacy of adalimumab was assessed in a randomised, double-blind, controlled study of 114 paediatric patients from 4 years of age with severe chronic plaque psoriasis (as defined by a PGA \geq 4 or $>$ 20 % BSA involvement or $>$ 10 % BSA involvement with very thick lesions or PASI \geq 20 or \geq 10 with clinically relevant facial, genital, or hand/foot involvement) who were inadequately controlled with topical therapy and heliotherapy or phototherapy.

Patients received adalimumab 0.8 mg/kg eow (up to 40 mg), 0.4 mg/kg eow (up to 20 mg), or methotrexate 0.1–0.4 mg/kg weekly (up to 25 mg). At Week 16, more patients randomised to adalimumab 0.8 mg/kg had positive efficacy responses (e.g., PASI 75) than those randomised to 0.4 mg/kg eow or MTX.

Table 27. Paediatric plaque psoriasis efficacy results at 16 weeks

	MTX ^a N = 37	adalimumab 0.8 mg/kg eow N=38
PASI 75 ^b	12 (32.4 %)	22 (57.9 %)
PGA: clear/minimal ^c	15 (40.5 %)	23 (60.5 %)

^a MTX = methotrexate

^b p = 0.027, adalimumab 0.8 mg/kg versus MTX

^c p = 0.083, adalimumab 0.8 mg/kg versus MTX

Patients who achieved PASI 75 and PGA clear or minimal were withdrawn from treatment for up to 36 weeks and monitored for loss of disease control (i.e. a worsening of PGA by at least 2 grades). Patients were then re-treated with adalimumab 0.8 mg/kg eow for an additional 16 weeks and response rates observed during retreatment were similar to the previous double-blind period: PASI 75 response of 78.9 % (15 of 19 subjects) and PGA clear or minimal of 52.6 % (10 of 19 subjects).

In the open label period of the study, PASI 75 and PGA clear or minimal responses were maintained for up to an additional 52 weeks with no new safety findings.

Adolescent hidradenitis suppurativa

There are no clinical studies with adalimumab in adolescent patients with HS. Efficacy of adalimumab for the treatment of adolescent patients with HS is predicted based on the demonstrated efficacy and exposure-response relationship in adult HS patients and the likelihood that the disease course, pathophysiology, and drug effects are substantially similar to that of adults at the same exposure levels. Safety of the recommended adalimumab dose in the adolescent HS population is based on cross-indication safety profile of adalimumab in both adults and paediatric patients at similar or more frequent doses (see section 5.2).

Paediatric Crohn's disease

Adalimumab was assessed in a multicentre, randomised, double-blind clinical study designed to evaluate the efficacy and safety of induction and maintenance treatment with doses dependent on body weight (< 40 kg or ≥ 40 kg) in 192 paediatric subjects between the ages of 6 and 17 (inclusive) years, with moderate to severe Crohn's disease (CD) defined as Paediatric Crohn's Disease Activity Index (PCDAI) score > 30. Subjects had to have failed conventional therapy (including a corticosteroid and/or an immunomodulator) for CD. Subjects may also have previously lost response or been intolerant to infliximab.

All subjects received open-label induction therapy at a dose based on their Baseline body weight: 160 mg at Week 0 and 80 mg at Week 2 for subjects ≥ 40 kg, and 80 mg and 40 mg, respectively, for subjects < 40 kg.

At Week 4, subjects were randomised 1:1 based on their body weight at the time to either the Low Dose or Standard Dose maintenance regimens as shown in Table 28.

Table 28. Maintenance regimen

patient weight	low dose	standard dose
< 40 kg	10 mg eow	20 mg eow
≥ 40 kg	20 mg eow	40 mg eow

Efficacy results

The primary endpoint of the study was clinical remission at Week 26, defined as PCDAI score ≤ 10.

Clinical remission and clinical response (defined as reduction in PCDAI score of at least 15 points from Baseline) rates are presented in Table 29. Rates of discontinuation of corticosteroids or immunomodulators are presented in Table 30.

**Table 29. Paediatric CD study
PCDAI clinical remission and response**

	standard dose 40/20 mg eow N = 93	low dose 20/10 mg eow N = 95	p value*
Week 26			
clinical remission	38.7 %	28.4 %	0.075
clinical response	59.1 %	48.4 %	0.073
Week 52			
clinical remission	33.3 %	23.2 %	0.100
clinical response	41.9 %	28.4 %	0.038

* p-value for standard dose *versus* low dose comparison.

Table 30. Paediatric CD study discontinuation of corticosteroids or immunomodulators and fistula remission

	standard dose 40/20 mg eow	low dose 20/10 mg eow	p value¹
discontinued corticosteroids	N = 33	N = 38	
Week 26	84.8 %	65.8 %	0.066
Week 52	69.7 %	60.5 %	0.420
discontinuation of Immunomodulators²	N = 60	N = 57	
Week 52	30.0 %	29.8 %	0.983
fistula remission³	N = 15	N = 21	
Week 26	46.7 %	38.1 %	0.608
Week 52	40.0 %	23.8 %	0.303

¹ p value for standard dose *versus* low dose comparison.

² immunosuppressant therapy could only be discontinued at or after Week 26 at the investigator's discretion if the subject met the clinical response criterion

³ defined as a closure of all fistulas that were draining at Baseline for at least 2 consecutive post-Baseline visits

Statistically significant increases (improvement) from Baseline to Week 26 and 52 in Body Mass Index and height velocity were observed for both treatment groups.

Statistically and clinically significant improvements from Baseline were also observed in both treatment groups for quality of life parameters (including IMPACT III).

One hundred patients (n = 100) from the Paediatric CD Study continued in an open-label long-term extension study. After 5 years of adalimumab therapy, 74.0 % (37/50) of the 50 patients remaining in the study continued to be in clinical remission, and 92.0 % (46/50) of patients continued to be in clinical response per PCDAI.

Paediatric ulcerative colitis

The safety and efficacy of adalimumab was assessed in a multicenter, randomized, double-blind, study in 93 paediatric patients from 5 to 17 years of age with moderate to severe ulcerative colitis (Mayo score 6 to 12 with endoscopy subscore of 2 to 3 points, confirmed by centrally read endoscopy) who had an inadequate response or intolerance to conventional therapy. Approximately 16 % of patients in the study had failed prior anti-TNF treatment. Patients who received corticosteroids at enrollment were allowed to taper their corticosteroid therapy after Week 4.

In the induction period of the study, 77 patients were randomized 3:2 to receive double-blind treatment with adalimumab at an induction dose of 2.4 mg/kg (maximum of 160 mg) at Week 0 and Week 1, and 1.2 mg/kg (maximum of 80 mg) at Week 2; or an induction dose of 2.4 mg/kg (maximum of 160 mg) at Week 0, placebo at Week 1, and 1.2 mg/kg (maximum of 80 mg) at Week 2. Both groups received 0.6 mg/kg (maximum of 40 mg) at Week 4 and Week 6. Following an amendment to the study design, the remaining 16 patients who enrolled in the induction period received open-label treatment with adalimumab at the induction dose of 2.4 mg/kg (maximum of 160 mg) at Week 0 and Week 1, and 1.2 mg/kg (maximum of 80 mg) at Week 2.

At Week 8, 62 patients who demonstrated clinical response per Partial Mayo Score (PMS; defined as a decrease in PMS ≥ 2 points and $\geq 30\%$ from Baseline) were randomized equally to receive double-blind maintenance treatment with adalimumab at a dose of 0.6 mg/kg (maximum of 40 mg) every week (ew), or a maintenance dose of 0.6 mg/kg (maximum of 40 mg) every other week (eow). Prior to an amendment to the study design, 12 additional patients who demonstrated clinical response per PMS were randomized to receive placebo but were not included in the confirmatory analysis of efficacy.

Disease flare was defined as an increase in PMS of at least 3 points (for patients with PMS of 0 to 2 at Week 8), at least 2 points (for patients with PMS of 3 to 4 at Week 8), or at least 1 point (for patients with PMS of 5 to 6 at Week 8).

Patients who met criteria for disease flare at or after Week 12 were randomized to receive a re-induction dose of 2.4 mg/kg (maximum of 160 mg) or a dose of 0.6 mg/kg (maximum of 40 mg) and continued to receive their respective maintenance dose regimen afterwards.

Efficacy results

The co-primary endpoints of the study were clinical remission per PMS (defined as PMS ≤ 2 and no individual subscore > 1) at Week 8, and clinical remission per FMS (Full Mayo Score) (defined as a Mayo Score ≤ 2 and no individual subscore > 1) at Week 52 in patients who achieved clinical response per PMS at Week 8.

Clinical remission rates per PMS at Week 8 for patients in each of the adalimumab doubleblind induction groups are presented in Table 31.

Table 31. Clinical remission per PMS at 8 weeks

	Adalimumab^a Maximum of 160 mg at Week 0/Placebo at Week 1 N=30	Adalimumab^{b, c} Maximum of 160 mg at Week 0 and Week 1 N=47
Clinical remission	13/30 (43.3 %)	28/47 (59.6 %)
^a Adalimumab 2.4 mg/kg (maximum of 160 mg) at Week 0, placebo at Week 1, and 1.2 mg/kg (maximum of 80 mg) at Week 2 ^b Adalimumab 2.4 mg/kg (maximum of 160 mg) at Week 0 and Week 1, and 1.2 mg/kg (maximum of 80 mg) at Week 2 ^c Not including open-label Induction dose of adalimumab 2.4 mg/kg (maximum of 160 mg) at Week 0 and Week 1, and 1.2 mg/kg (maximum of 80 mg) at Week 2 Note 1: Both induction groups received 0.6 mg/kg (maximum of 40 mg) at Week 4 and Week 6 Note 2: Patients with missing values at Week 8 were considered as not having met the endpoint		

At Week 52, clinical remission per FMS in Week 8 responders, clinical response per FMS (defined as a decrease in Mayo Score ≥ 3 points and $\geq 30\%$ from Baseline) in Week 8 responders, mucosal healing per FMS (defined as an Mayo endoscopy score ≤ 1) in Week 8 responders, clinical remission per FMS in Week 8 remitters, and the proportion of subjects in corticosteroid-free remission per FMS in Week 8 responders were assessed in patients who received adalimumab at the double-blind maximum 40 mg eow (0.6 mg/kg) and maximum 40 mg ew (0.6 mg/kg) maintenance doses (Table 32).

Table 32. Efficacy results at 52 weeks

	Adalimumab^a Maximum of 40 mg ew N=31	Adalimumab^b Maximum of 40 mg ew N=31
Clinical remission in Week 8 PMS responders	9/31 (29.0 %)	14/31 (45.2 %)
Clinical response in Week 8 PMS responders	19/31 (61.3 %)	21/31 (67.7 %)
Mucosal healing in Week 8 PMS responders	12/31 (38.7 %)	16/31 (51.6 %)
Clinical remission in Week 8 PMS remitters	9/21 (42.9 %)	10/22 (45.5 %)
Corticosteroid-free remission in Week 8 PMS responders ^c	4/13 (30.8 %)	5/16 (31.3 %)
^a Adalimumab 0.6 mg/kg (maximum of 40 mg) every other week ^b Adalimumab 0.6 mg/kg (maximum of 40 mg) every week ^c In patients receiving concomitant corticosteroids at baseline Note: Patients with missing values at Week 52 or who were randomized to receive re-induction or maintenance treatment were considered non-responders for Week 52 endpoints		

Additional exploratory efficacy endpoints included clinical response per the Paediatric Ulcerative Colitis Activity Index (PUCAI) (defined as a decrease in PUCAI \geq 20 points from Baseline) and clinical remission per PUCAI (defined as PUCAI < 10) at Week 8 and Week 52 (Table 33).

Table 33. Exploratory endpoints results per PUCAI

	Week 8	
	Adalimumab^a Maximum of 160 mg at Week 0/Placebo at Week 1 N=30	Adalimumab^{b,c} Maximum of 160 mg at Week 0 and Week 1 N=47
Clinical remission per PUCAI	10/30 (33.3%)	22/47 (46.8%)
Clinical response per PUCAI	15/30 (50.0%)	32/47 (68.1%)

	Week 52	
	Adalimumab ^d Maximum of 40 mg ew N=31	Adalimumab ^e Maximum of 40 mg ew N=31
Clinical remission per PUCAI in Week 8 PMS responders	14/31 (45.2%)	18/31 (58.1%)
Clinical response per PUCAI in Week 8 PMS responders	18/31 (58.1%)	16/31 (51.6%)
<p>^a Adalimumab 2.4 mg/kg (maximum of 160 mg) at Week 0, placebo at Week 1, and 1.2 mg/kg (maximum of 80 mg) at Week 2</p> <p>^b Adalimumab 2.4 mg/kg (maximum of 160 mg) at Week 0 and Week 1, and 1.2 mg/kg (maximum of 80 mg) at Week 2</p> <p>^c Not including open-label Induction dose of adalimumab 2.4 mg/kg (maximum of 160 mg) at Week 0 and Week 1, and 1.2 mg/kg (maximum of 80 mg) at Week 2</p> <p>^d Adalimumab 0.6 mg/kg (maximum of 40 mg) every other week</p> <p>^e Adalimumab 0.6 mg/kg (maximum of 40 mg) every week</p> <p>Note 1: Both induction groups received 0.6 mg/kg (maximum of 40 mg) at Week 4 and Week 6</p> <p>Note 2: Patients with missing values at Week 8 were considered as not having met the endpoints</p> <p>Note 3: Patients with missing values at Week 52 or who were randomized to receive reinduction or maintenance treatment were considered non-responders for Week 52 endpoints</p>		

Of the adalimumab -treated patients who received re-induction treatment during the maintenance period, 2/6 (33 %) achieved clinical response per FMS at Week 52.

Quality of life

Clinically meaningful improvements from Baseline were observed in IMPACT III and the caregiver Work Productivity and Activity Impairment (WPAI) scores for the groups treated with adalimumab.

Clinically meaningful increases (improvement) from Baseline in height velocity were observed for the groups treated with adalimumab, and clinically meaningful increases (improvement) from Baseline in Body Mass Index were observed for subjects on the high maintenance dose of maximum 40 mg (0.6 mg/kg) ew.

Paediatric uveitis

The safety and efficacy of adalimumab was assessed in a randomized, double-masked, controlled study of 90 paediatric patients from 2 to < 18 years of age with active JIA-associated non-infectious anterior uveitis who were refractory to at least 12 weeks of methotrexate treatment. Patients received either placebo or 20 mg adalimumab (if < 30 kg) or 40 mg adalimumab (if ≥ 30 kg) every other week in combination with their baseline dose of methotrexate.

The primary endpoint was ‘time to treatment failure’. The criteria determining treatment failure were worsening or sustained non-improvement in ocular inflammation, partial improvement with development of sustained ocular co-morbidities or worsening of ocular co-morbidities, non-permitted use of concomitant medicinal products, and suspension of treatment for an extended period of time.

Clinical response

Adalimumab significantly delayed the time to treatment failure, as compared to placebo (See Figure 3, P < 0.0001 from log rank test). The median time to treatment failure was 24.1 weeks for subjects treated with placebo, whereas the median time to treatment failure was not estimable for subjects treated with adalimumab because less than one-half of these subjects experienced treatment

failure. Adalimumab significantly decreased the risk of treatment failure by 75 % relative to placebo, as shown by the hazard ratio (HR = 0.25 [95 % CI: 0.12, 0.49]).

Figure 3: Kaplan-Meier curves summarizing time to treatment failure in the paediatric uveitis study

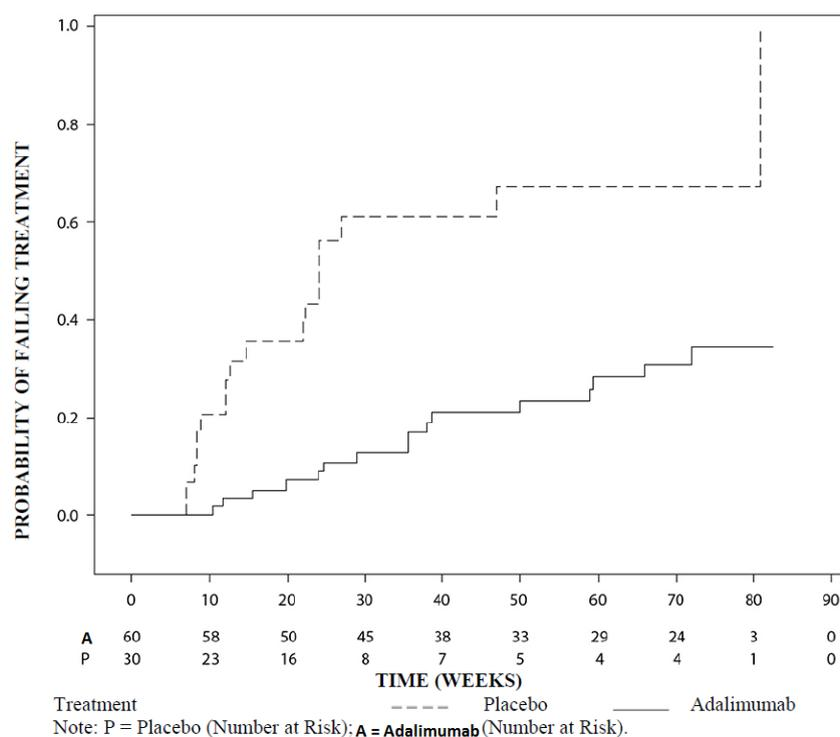

5.2 Pharmacokinetic properties

Absorption and distribution

After subcutaneous administration of a single 40 mg dose, absorption and distribution of adalimumab was slow, with peak serum concentrations being reached about 5 days after administration. The average absolute bioavailability of adalimumab estimated from three studies following a single 40 mg subcutaneous dose was 64 %. After single intravenous doses ranging from 0.25 to 10 mg/kg, concentrations were dose proportional. After doses of 0.5 mg/kg (~40 mg), clearances ranged from 11 to 15 ml/hour, the distribution volume (V_{SS}) ranged from 5 to 6 litres and the mean terminal phase half-life was approximately two weeks. Adalimumab concentrations in the synovial fluid from several rheumatoid arthritis patients ranged from 31–96 % of those in serum.

Following subcutaneous administration of 40 mg of adalimumab every other week in adult rheumatoid arthritis (RA) patients the mean steady-state trough concentrations were approximately 5 µg/ml (without concomitant methotrexate) and 8 to 9 µg/ml (with concomitant methotrexate), respectively. The serum adalimumab trough levels at steady-state increased roughly proportionally with dose following 20, 40 and 80 mg subcutaneous dosing every other week and every week.

Following the administration of 24 mg/m² (a maximum of 40 mg) subcutaneously every other week to patients with polyarticular juvenile idiopathic arthritis (JIA) who were 4 to 17 years the mean trough steady-state (values measured from Week 20 to 48) serum adalimumab concentration was 5.6 ± 5.6 µg/ml (102 % CV) for adalimumab without concomitant methotrexate and 10.9 ± 5.2 µg/ml (47.7 % CV) with concomitant methotrexate.

In patients with polyarticular JIA who were 2 to < 4 years old or aged 4 and above weighing < 15 kg

dosed with adalimumab 24 mg/m², the mean trough steady-state serum adalimumab concentrations was 6.0 ± 6.1 µg/ml (101 % CV) for adalimumab without concomitant methotrexate and 7.9 ± 5.6 µg/ml (71.2 % CV) with concomitant methotrexate.

Following the administration of 24 mg/m² (a maximum of 40 mg) subcutaneously every other week to patients with enthesitis-related arthritis who were 6 to 17 years, the mean trough steady-state (values measured at Week 24) serum adalimumab concentrations were 8.8 ± 6.6 µg/ml for adalimumab without concomitant methotrexate and 11.8 ± 4.3 µg/ml with concomitant methotrexate.

In adult patients with psoriasis, the mean steady-state trough concentration was 5 µg/ml during adalimumab 40 mg every other week monotherapy treatment.

Following the administration of 0.8 mg/kg (a maximum of 40 mg) subcutaneously every other week to paediatric patients with chronic plaque psoriasis, the mean ± SD steady-state adalimumab trough concentration was approximately 7.4 ± 5.8 µg/ml (79 % CV).

Following subcutaneous administration of 40 mg of adalimumab every other week in adult non-radiographic axial spondyloarthritis patients, the mean (±SD) trough steady-state concentration at Week 68 was 8.0 ± 4.6 µg/ml.

In adult patients with hidradenitis suppurativa, a dose of 160 mg adalimumab on Week 0 followed by 80 mg on Week 2 achieved serum adalimumab trough concentrations of approximately 7 to 8 µg/ml at Week 2 and Week 4. The mean steady-state trough concentration at Week 12 through Week 36 were approximately 8 to 10 µg/ml during adalimumab 40 mg every week treatment.

Adalimumab exposure in adolescent HS patients was predicted using population pharmacokinetic modelling and simulation based on cross-indication pharmacokinetics in other paediatric patients (paediatric psoriasis, juvenile idiopathic arthritis, paediatric Crohn's disease, and enthesitis-related arthritis). The recommended adolescent HS dosing schedule is 40 mg every other week. Since exposure to adalimumab can be affected by body size, adolescents with higher body weight and inadequate response may benefit from receiving the recommended adult dose of 40 mg every week.

In patients with Crohn's disease, the loading dose of 80 mg adalimumab on Week 0 followed by 40 mg adalimumab on Week 2 achieves serum adalimumab trough concentrations of approximately 5.5 µg/ml during the induction period. A loading dose of 160 mg adalimumab on Week 0 followed by 80 mg adalimumab on Week 2 achieves serum adalimumab trough concentrations of approximately 12 µg/ml during the induction period. Mean steady-state trough levels of approximately 7 µg/ml were observed in Crohn's disease patients who received a maintenance dose of 40 mg adalimumab every other week.

In paediatric patients with moderate to severe CD, the open-label adalimumab induction dose was 160/80 mg or 80/40 mg at Weeks 0 and 2, respectively, dependent on a body weight cut-off of 40 kg. At Week 4, patients were randomised 1:1 to either the Standard Dose (40/20 mg eow) or Low Dose (20/10 mg eow) maintenance treatment groups based on their body weight. The mean (± SD) serum adalimumab trough concentrations achieved at Week 4 were 15.7±6.6 µg/ml for patients ≥ 40 kg (160/80 mg) and 10.6 ± 6.1 µg/ml for patients < 40 kg (80/40 mg).

For patients who stayed on their randomised therapy, the mean (± SD) adalimumab trough concentrations at Week 52 were 9.5 ± 5.6 µg/ml for the Standard Dose group and 3.5 ± 2.2 µg/ml for the Low Dose group. The mean trough concentrations were maintained in patients who continued to receive adalimumab treatment eow for 52 weeks. For patients who dose-escalated from eow to weekly regimen, the mean (± SD) serum concentrations of adalimumab at Week 52 were 15.3 ± 11.4 µg/ml (40/20 mg, weekly) and 6.7 ± 3.5 µg/ml (20/10 mg, weekly).

In patients with ulcerative colitis, a loading dose of 160 mg adalimumab on Week 0 followed by 80 mg adalimumab on Week 2 achieves serum adalimumab trough concentrations of approximately 12 µg/ml during the induction period. Mean steady-state trough levels of approximately 8 µg/ml were observed

in ulcerative colitis patients who received a maintenance dose of 40 mg adalimumab every other week.

Following the subcutaneous administration of body weight-based dosing of 0.6 mg/kg (maximum of 40 mg) every other week to paediatric patients with ulcerative colitis, the mean trough steady-state serum adalimumab concentration was 5.01 ± 3.28 µg/ml at Week 52. For patients who received 0.6 mg/kg (maximum of 40 mg) every week, the mean (\pm SD) trough steady-state serum adalimumab concentration was 15.7 ± 5.60 µg/ml at Week 52.

In adult patients with uveitis, a loading dose of 80 mg adalimumab on Week 0 followed by 40 mg adalimumab every other week starting at Week 1, resulted in mean steady-state concentrations of approximately 8 to 10 µg/ml.

Adalimumab exposure in paediatric uveitis patients was predicted using population pharmacokinetic modelling and simulation based on cross-indication pharmacokinetics in other paediatric patients (paediatric psoriasis, juvenile idiopathic arthritis, paediatric Crohn's disease, and enthesitis-related arthritis). No clinical exposure data are available on the use of a loading dose in children < 6 years. The predicted exposures indicate that in the absence of methotrexate, a loading dose may lead to an initial increase in systemic exposure.

Population pharmacokinetic and pharmacokinetic/pharmacodynamic modelling and simulation predicted comparable adalimumab exposure and efficacy in patients treated with 80 mg every other week when compared with 40 mg every week (including adult patients with RA, HS, UC, CD or Ps, patients with adolescent HS, and paediatric patients \geq 40 kg with CD and UC).

Exposure-response relationship in paediatric population

On the basis of clinical study data in patients with JIA (pJIA and ERA), an exposure-response relationship was established between plasma concentrations and PedACR 50 response. The apparent adalimumab plasma concentration that produces half the maximum probability of PedACR 50 response (EC₅₀) was 3 µg/ml (95 % CI: 1-6 µg/ml).

Exposure-response relationships between adalimumab concentration and efficacy in paediatric patients with severe chronic plaque psoriasis were established for PASI 75 and PGA clear or minimal, respectively. PASI 75 and PGA clear or minimal increased with increasing adalimumab concentrations, both with a similar apparent EC₅₀ of approximately 4.5 µg/mL (95 % CI 0.4-47.6 and 1.9-10.5, respectively).

Elimination

Population pharmacokinetic analyses with data from over 1 300 RA patients revealed a trend toward higher apparent clearance of adalimumab with increasing body weight. After adjustment for weight differences, gender and age appeared to have a minimal effect on adalimumab clearance. The serum levels of free adalimumab (not bound to anti-adalimumab antibodies, AAA) were observed to be lower in patients with measurable AAA.

Hepatic or renal impairment

Adalimumab has not been studied in patients with hepatic or renal impairment.

5.3 Preclinical safety data

Non-clinical data reveal no special hazard for humans based on studies of single-dose toxicity, repeated dose toxicity, and genotoxicity.

An embryo-foetal developmental toxicity/perinatal developmental study has been performed in cynomolgus monkeys at 0, 30 and 100 mg/kg (9–17 monkeys/group) and has revealed no evidence of harm to the foetuses due to adalimumab. Neither carcinogenicity studies, nor a standard

assessment of fertility and postnatal toxicity, were performed with adalimumab due to the lack of appropriate models for an antibody with limited cross-reactivity to rodent TNF and to the development of neutralising antibodies in rodents.

6. PHARMACEUTICAL PARTICULARS

6.1 List of excipients

Adipic acid
Citric acid monohydrate
Sodium chloride
Mannitol (E 421)
Polysorbate 80 (E 433)
Hydrochloric acid (for pH adjustment) (E 507)
Sodium hydroxide (for pH adjustment) (E 524)
Water for injections

6.2 Incompatibilities

In the absence of compatibility studies, this medicinal product must not be mixed with other medicinal products.

6.3 Shelf life

30 months

6.4 Special precautions for storage

Store in a refrigerator (2°C–8°C). Do not freeze. Keep the pre-filled syringe/pre-filled pen in the outer carton in order to protect from light.

A single Hyrimoz pre-filled syringe/pre-filled pen may be stored at temperatures up to a maximum of 25°C for a period of up to 21 days. The pre-filled syringe/pre-filled pen must be protected from light, and discarded if not used within the 21-day period.

6.5 Nature and contents of container

Hyrimoz 20 mg solution for injection in pre-filled syringe

0.4 ml solution in a single-use clear type I glass syringe with a rubber stopper (bromobutyl rubber) and a stainless steel 29 gauge needle with an automatic needle guard with finger flange, rubber needle cap (thermoplastic elastomer) and plastic plunger.

Pack of 2 pre-filled syringes in a blister

Hyrimoz 40 mg solution for injection in pre-filled syringe

0.8 ml solution in a single-use clear type I glass syringe with a rubber stopper (bromobutyl rubber) and a stainless steel 29 gauge needle with an automatic needle guard with finger flange, rubber needle cap (thermoplastic elastomer) and plastic plunger.

Packs of 1 and 2 pre-filled syringes in a blister

Multipack containing 6 (3 packs of 2) pre-filled syringes in a blister

Hyrimoz 40 mg solution for injection in pre-filled pen

0.8 ml solution in a single-use pre-filled syringe assembled into a triangular-shaped pen with transparent window and label. The syringe inside the pen is made of type I glass with a stainless steel 29 gauge needle, an inner rubber needle cap (thermoplastic elastomer), and a rubber stopper (bromobutyl rubber).

Packs of 1 and 2 pre-filled pens

Multipack containing 6 (3 packs of 2) pre-filled pens

Not all pack sizes may be marketed.

6.6 Special precautions for disposal

Any unused medicinal product or waste material should be disposed of in accordance with local requirements.

Full instructions for use are given in the package leaflet, section 7, "Instructions for Use".

7. MARKETING AUTHORISATION HOLDER

Sandoz GmbH
Biochemiestr. 10
6250 Kundl
Austria

8. MARKETING AUTHORISATION NUMBERS

Hyrimoz 20 mg solution for injection in pre-filled syringe

EU/1/18/1286/007

Hyrimoz 40 mg solution for injection in pre-filled syringe

EU/1/18/1286/001

EU/1/18/1286/002

EU/1/18/1286/003

Hyrimoz 40 mg solution for injection in pre-filled pen

EU/1/18/1286/004

EU/1/18/1286/005

EU/1/18/1286/006

9. DATE OF FIRST AUTHORISATION/RENEWAL OF THE AUTHORISATION

Date of first authorisation: 26 July 2018

Date of latest renewal: 15 February 2023

10. DATE OF REVISION OF THE TEXT

Detailed information on this medicinal product is available on the website of the European Medicines Agency <https://www.ema.europa.eu>.

1. NAME OF THE MEDICINAL PRODUCT

Hyrimoz 20 mg solution for injection in pre-filled syringe

Hyrimoz 40 mg solution for injection in pre-filled syringe

Hyrimoz 40 mg solution for injection in pre-filled pen

Hyrimoz 80 mg solution for injection in pre-filled syringe

Hyrimoz 80 mg solution for injection in pre-filled pen

2. QUALITATIVE AND QUANTITATIVE COMPOSITION

Hyrimoz 20 mg solution for injection in pre-filled syringe

Each 0.2 ml single-dose pre-filled syringe contains 20 mg of adalimumab.

Hyrimoz 40 mg solution for injection in pre-filled syringe

Each 0.4 ml single-dose pre-filled syringe contains 40 mg of adalimumab.

Hyrimoz 40 mg solution for injection in pre-filled pen

Each 0.4 ml single-dose pre-filled pen contains 40 mg of adalimumab.

Hyrimoz 80 mg solution for injection in pre-filled syringe

Each 0.8 ml single-dose pre-filled syringe contains 80 mg of adalimumab.

Hyrimoz 80 mg solution for injection in pre-filled pen

Each 0.8 ml single-dose pre-filled pen contains 80 mg of adalimumab.

Adalimumab is a recombinant human monoclonal antibody produced in Chinese Hamster Ovary cells.

For the full list of excipients, see section 6.1.

3. PHARMACEUTICAL FORM

Solution for injection (injection) in pre-filled syringe

Solution for injection (injection) in pre-filled pen (SensoReady)

Clear to slightly opalescent, colourless or slightly yellowish solution.

4. CLINICAL PARTICULARS

4.1 Therapeutic indications

Rheumatoid arthritis

Hyrimoz in combination with methotrexate, is indicated for:

- the treatment of moderate to severe, active rheumatoid arthritis in adult patients when the response to disease-modifying anti-rheumatic drugs including methotrexate has been inadequate.
- the treatment of severe, active and progressive rheumatoid arthritis in adults not previously treated with methotrexate.

Hyrimoz can be given as monotherapy in case of intolerance to methotrexate or when continued treatment with methotrexate is inappropriate.

Adalimumab has been shown to reduce the rate of progression of joint damage as measured by X-ray and to improve physical function, when given in combination with methotrexate.

Juvenile idiopathic arthritis

Polyarticular juvenile idiopathic arthritis

Hyrimoz in combination with methotrexate is indicated for the treatment of active polyarticular juvenile idiopathic arthritis, in patients from the age of 2 years who have had an inadequate response to one or more disease-modifying anti-rheumatic drugs (DMARDs). Hyrimoz can be given as monotherapy in case of intolerance to methotrexate or when continued treatment with methotrexate is inappropriate (for the efficacy in monotherapy, see section 5.1). Adalimumab has not been studied in patients aged less than 2 years.

Enthesitis-related arthritis

Hyrimoz is indicated for the treatment of active enthesitis-related arthritis in patients, 6 years of age and older, who have had an inadequate response to, or who are intolerant of, conventional therapy (see section 5.1).

Axial spondyloarthritis

Ankylosing spondylitis (AS)

Hyrimoz is indicated for the treatment of adults with severe active ankylosing spondylitis who have had an inadequate response to conventional therapy.

Axial spondyloarthritis without radiographic evidence of AS

Hyrimoz is indicated for the treatment of adults with severe axial spondyloarthritis without radiographic evidence of AS but with objective signs of inflammation by elevated CRP and/or MRI, who have had an inadequate response to, or are intolerant to non-steroidal anti-inflammatory drugs (NSAIDs).

Psoriatic arthritis

Hyrimoz is indicated for the treatment of active and progressive psoriatic arthritis in adults when the response to previous disease-modifying anti-rheumatic drug therapy has been inadequate.

Adalimumab has been shown to reduce the rate of progression of peripheral joint damage as measured by X-ray in patients with polyarticular symmetrical subtypes of the disease (see section 5.1) and to improve physical function.

Psoriasis

Hyrimoz is indicated for the treatment of moderate to severe chronic plaque psoriasis in adult patients who are candidates for systemic therapy.

Paediatric plaque psoriasis

Hyrimoz is indicated for the treatment of severe chronic plaque psoriasis in children and adolescents from 4 years of age who have had an inadequate response to or are inappropriate candidates for topical therapy and phototherapies.

Hidradenitis suppurativa (HS)

Hyrimoz is indicated for the treatment of active moderate to severe hidradenitis suppurativa (acne inversa) in adults and adolescents from 12 years of age with an inadequate response to conventional systemic HS therapy (see sections 5.1 and 5.2).

Crohn's disease

Hyrimoz is indicated for treatment of moderately to severely active Crohn's disease in adult patients who have not responded despite a full and adequate course of therapy with a corticosteroid and/or an immunosuppressant; or who are intolerant to or have medical contraindications for such therapies.

Paediatric Crohn's disease

Hyrimoz is indicated for the treatment of moderately to severely active Crohn's disease in paediatric patients (from 6 years of age) who have had an inadequate response to conventional therapy including primary nutrition therapy and a corticosteroid and/or an immunomodulator, or who are intolerant to or have contraindications for such therapies.

Ulcerative colitis

Hyrimoz is indicated for treatment of moderately to severely active ulcerative colitis in adult patients who have had an inadequate response to conventional therapy including corticosteroids and 6-mercaptopurine (6-MP) or azathioprine (AZA), or who are intolerant to or have medical contraindications for such therapies.

Paediatric ulcerative colitis

Hyrimoz is indicated for the treatment of moderately to severely active ulcerative colitis in paediatric patients (from 6 years of age) who have had an inadequate response to conventional therapy including corticosteroids and/or 6-mercaptopurine (6-MP) or azathioprine (AZA), or who are intolerant to or have medical contraindications for such therapies.

Uveitis

Hyrimoz is indicated for the treatment of non-infectious intermediate, posterior and panuveitis in adult patients who have had an inadequate response to corticosteroids, in patients in need of corticosteroid-sparing, or in whom corticosteroid treatment is inappropriate.

Paediatric uveitis

Hyrimoz is indicated for the treatment of paediatric chronic non-infectious anterior uveitis in patients from 2 years of age who have had an inadequate response to or are intolerant to conventional therapy, or in whom conventional therapy is inappropriate.

4.2 Posology and method of administration

Hyrimoz treatment should be initiated and supervised by specialist physicians experienced in the diagnosis and treatment of conditions for which Hyrimoz is indicated. Ophthalmologists are advised to consult with an appropriate specialist before initiation of treatment with Hyrimoz (see section 4.4). Patients treated with Hyrimoz should be given the Patient Reminder Card.

After proper training in injection technique, patients may self-inject with Hyrimoz if their physician determines that it is appropriate and with medical follow-up as necessary.

During treatment with Hyrimoz, other concomitant therapies (e.g., corticosteroids and/or immunomodulatory agents) should be optimised.

Posology

Rheumatoid arthritis

The recommended dose of Hyrimoz for adult patients with rheumatoid arthritis is 40 mg adalimumab administered every other week as a single dose via subcutaneous injection. Methotrexate should be continued during treatment with Hyrimoz.

Glucocorticoids, salicylates, non-steroidal anti-inflammatory drugs, or analgesics can be continued during treatment with Hyrimoz. Regarding combination with disease-modifying anti-rheumatic drugs other than methotrexate, see sections 4.4 and 5.1.

In monotherapy, some patients who experience a decrease in their response to Hyrimoz 40 mg every other week may benefit from an increase in dose to 40 mg adalimumab every week or 80 mg every other week.

Available data suggest that the clinical response is usually achieved within 12 weeks of treatment. Continued therapy should be reconsidered in a patient not responding within this time period.

Hyrimoz may be available in other strengths and/or pharmaceutical forms depending on the individual treatment needs.

Dose interruption

There may be a need for dose interruption, for instance before surgery or if a serious infection occurs.

Available data suggest that re-introduction of adalimumab after discontinuation for 70 days or longer resulted in the same magnitudes of clinical response and similar safety profile as before dose interruption.

Ankylosing spondylitis, axial spondyloarthritis without radiographic evidence of AS and psoriatic arthritis

The recommended dose of Hyrimoz for patients with ankylosing spondylitis, axial spondyloarthritis without radiographic evidence of AS and for patients with psoriatic arthritis is 40 mg adalimumab administered every other week as a single dose via subcutaneous injection.

Available data suggest that the clinical response is usually achieved within 12 weeks of treatment. Continued therapy should be reconsidered in a patient not responding within this time period.

Psoriasis

The recommended dose of Hyrimoz for adult patients is an initial dose of 80 mg administered subcutaneously, followed by 40 mg subcutaneously given every other week starting one week after the

initial dose.

Hyrimoz 40 mg solution for injection in pre-filled syringe and/or pre-filled pen is available for the maintenance dose.

Continued therapy beyond 16 weeks should be carefully reconsidered in a patient not responding within this time period.

Beyond 16 weeks, patients with inadequate response to Hyrimoz 40 mg every other week may benefit from an increase in dose to 40 mg every week or 80 mg every other week. The benefits and risks of continued 40 mg weekly or 80 mg every other week therapy should be carefully reconsidered in a patient with an inadequate response after the increase in dose (see section 5.1). If adequate response is achieved with 40 mg every week or 80 mg every other week, the dose may subsequently be reduced to 40 mg every other week.

Hyrimoz may be available in other strengths and/or pharmaceutical forms depending on the individual treatment needs.

Hidradenitis suppurativa

The recommended Hyrimoz dose regimen for adult patients with hidradenitis suppurativa (HS) is 160 mg initially at Day 1 (given as two 80 mg injections or four 40 mg injections in one day or as one 80 mg injection or two 40 mg injections per day for two consecutive days), followed by 80 mg two weeks later at Day 15 (given as one 80 mg injection or two 40 mg injections in one day). Two weeks later (Day 29) continue with a dose of 40 mg every week or 80 mg every other week (given as one 80 mg injection or two 40 mg injections in one day). Antibiotics may be continued during treatment with Hyrimoz, if necessary. It is recommended that the patient should use a topical antiseptic wash on their HS lesions on a daily basis during treatment with Hyrimoz.

Continued therapy beyond 12 weeks should be carefully reconsidered in a patient with no improvement within this time period.

Should treatment be interrupted, Hyrimoz 40 mg every week or 80 mg every other week may be re-introduced (see section 5.1).

The benefit and risk of continued long-term treatment should be periodically evaluated (see section 5.1).

Hyrimoz may be available in other strengths and/or pharmaceutical forms depending on the individual treatment needs.

Crohn's disease

The recommended Hyrimoz induction dose regimen for adult patients with moderately to severely active Crohn's disease is 80 mg at Week 0 followed by 40 mg at Week 2. In case there is a need for a more rapid response to therapy, the regimen 160 mg at Week 0 (given as two 80 mg injections or four 40 mg injections in one day or as one 80 mg injection or two 40 mg injections per day for two consecutive days), followed by 80 mg at Week 2 (given as one 80 mg injection or two 40 mg injections in one day), can be used with the awareness that the risk for adverse events is higher during induction.

After induction treatment, the recommended dose is 40 mg every other week via subcutaneous injection. Alternatively, if a patient has stopped Hyrimoz and signs and symptoms of disease recur, Hyrimoz may be re-administered. There is little experience from re-administration after more than 8 weeks since the previous dose.

During maintenance treatment, corticosteroids may be tapered in accordance with clinical practice

guidelines.

Some patients who experience decrease in their response to Hyrimoz 40 mg every other week may benefit from an increase in dose to 40 mg Hyrimoz every week or 80 mg every other week.

Some patients who have not responded by Week 4 may benefit from continued maintenance therapy through Week 12. Continued therapy should be carefully reconsidered in a patient not responding within this time period.

Hyrimoz may be available in other strengths and/or pharmaceutical forms depending on the individual treatment needs.

Ulcerative colitis

The recommended Hyrimoz induction dose regimen for adult patients with moderate to severe ulcerative colitis is 160 mg at Week 0 (given as two 80 mg injections or four 40 mg injections in one day or as one 80 mg injection or two 40 mg injections per day for two consecutive days) and 80 mg at Week 2 (given as one 80 mg injection or two 40 mg injections in one day). After induction treatment, the recommended dose is 40 mg every other week via subcutaneous injection.

During maintenance treatment, corticosteroids may be tapered in accordance with clinical practice guidelines.

Some patients who experience decrease in their response to Hyrimoz 40 mg every other week may benefit from an increase in dose to 40 mg Hyrimoz every week or 80 mg every other week.

Available data suggest that the clinical response is usually achieved within 2–8 weeks of treatment. Hyrimoz therapy should not be continued in patients failing to respond within this time period.

Hyrimoz may be available in other strengths and/or pharmaceutical forms depending on the individual treatment needs.

Uveitis

The recommended dose of Hyrimoz for adult patients with uveitis is an initial dose of 80 mg, followed by 40 mg given every other week starting one week after the initial dose. Hyrimoz 40 mg solution for injection in pre-filled syringe and/or pre-filled pen is available for the maintenance dose. There is limited experience in the initiation of treatment with adalimumab alone. Treatment with Hyrimoz can be initiated in combination with corticosteroids and/or with other non-biologic immunomodulatory agents. Concomitant corticosteroids may be tapered in accordance with clinical practice starting two weeks after initiating treatment with Hyrimoz.

It is recommended that the benefit and risk of continued long-term treatment should be evaluated on a yearly basis (see section 5.1).

Hyrimoz may be available in other strengths and/or pharmaceutical forms depending on the individual treatment needs.

Special populations

Elderly

No dose adjustment is required.

Renal and/or hepatic impairment

Adalimumab has not been studied in these patient populations. No dose recommendations can be made.

Paediatric population

Juvenile idiopathic arthritis

Polyarticular juvenile idiopathic arthritis from 2 years of age

The recommended dose of Hyrimoz for patients with polyarticular juvenile idiopathic arthritis from 2 years of age is based on body weight (Table 1). Hyrimoz is administered every other week via subcutaneous injection.

Table 1. Hyrimoz dose for patients with polyarticular juvenile idiopathic arthritis

Patient weight	Dosing regimen
10 kg to < 30 kg	20 mg every other week
≥ 30 kg	40 mg every other week

Available data suggest that clinical response is usually achieved within 12 weeks of treatment. Continued therapy should be carefully reconsidered in a patient not responding within this time period.

There is no relevant use of adalimumab in patients aged less than 2 years for this indication.

Hyrimoz may be available in other strengths and/or pharmaceutical forms depending on the individual treatment needs.

Enthesitis-related arthritis

The recommended dose of Hyrimoz for patients with enthesitis-related arthritis from 6 years of age is based on body weight (Table 2). Hyrimoz is administered every other week via subcutaneous injection.

Table 2. Hyrimoz dose for patients with enthesitis-related arthritis

Patient weight	Dosing regimen
15 kg to < 30 kg	20 mg every other week
≥ 30 kg	40 mg every other week

Adalimumab has not been studied in patients with enthesitis-related arthritis aged less than 6 years.

Hyrimoz may be available in other strengths and/or pharmaceutical forms depending on the individual treatment needs.

Psoriatic arthritis and axial spondyloarthritis including ankylosing spondylitis

There is no relevant use of adalimumab in the paediatric population for the indications of ankylosing spondylitis and psoriatic arthritis.

Paediatric plaque psoriasis

The recommended Hyrimoz dose for patients with plaque psoriasis from 4 to 17 years of age is based on body weight (Table 3). Hyrimoz is administered via subcutaneous injection.

Table 3. Hyrimoz dose for paediatric patients with plaque psoriasis

Patient weight	Dosing regimen
15 kg to < 30 kg	Initial dose of 20 mg, followed by 20 mg every other week starting one week after the initial dose
≥ 30 kg	Initial dose of 40 mg, followed by 40 mg given every other week starting one week after the initial dose

Continued therapy beyond 16 weeks should be carefully considered in a patient not responding within this time period.

If re-treatment with adalimumab is indicated, the above guidance on dose and treatment duration should be followed.

The safety of adalimumab in paediatric patients with plaque psoriasis has been assessed for a mean of 13 months.

There is no relevant use of adalimumab in children aged less than 4 years for this indication.

Hyrimoz may be available in other strengths and/or pharmaceutical forms depending on the individual treatment needs.

Adolescent hidradenitis suppurativa (from 12 years of age, weighing at least 30 kg)

There are no clinical studies with adalimumab in adolescent patients with HS. The posology of adalimumab in these patients has been determined from pharmacokinetic modelling and simulation (see section 5.2).

The recommended Hyrimoz dose is 80 mg at Week 0 followed by 40 mg every other week starting at Week 1 via subcutaneous injection.

In adolescent patients with inadequate response to Hyrimoz 40 mg every other week, an increase in dose to 40 mg every week or 80 mg every other week may be considered.

Antibiotics may be continued during treatment with Hyrimoz if necessary. It is recommended that the patient should use a topical antiseptic wash on their HS lesions on a daily basis during treatment with Hyrimoz.

Continued therapy beyond 12 weeks should be carefully reconsidered in a patient with no improvement within this time period.

Should treatment be interrupted, Hyrimoz may be re-introduced as appropriate.

The benefit and risk of continued long-term treatment should be periodically evaluated (see adult data in section 5.1)

There is no relevant use of adalimumab in children aged less than 12 years in this indication.

Hyrimoz may be available in other strengths and/or pharmaceutical forms depending on the individual treatment needs.

Paediatric Crohn's disease

The recommended dose of Hyrimoz for patients with Crohn's disease from 6 to 17 years of age is based on body weight (Table 4). Hyrimoz is administered via subcutaneous injection.

Table 4. Hyrimoz dose for paediatric patients with Crohn's disease

Patient weight	Induction dose	Maintenance dose starting at Week 4
< 40 kg	<ul style="list-style-type: none"> 40 mg at Week 0 and 20 mg at Week 2 <p>In case there is a need for a more rapid response to therapy with the awareness that the risk for adverse events may be higher with use of the higher induction dose, the following dose may be used:</p> <ul style="list-style-type: none"> 80 mg at Week 0 and 40 mg at Week 2 	20 mg every other week
≥ 40 kg	<ul style="list-style-type: none"> 80 mg at Week 0 and 40 mg at Week 2 <p>In case there is a need for a more rapid response to therapy with the awareness that the risk for adverse events may be higher with use of the higher induction dose, the following dose may be used:</p> <ul style="list-style-type: none"> 160 mg at Week 0 and 80 mg at Week 2 	40 mg every other week

Patients who experience insufficient response may benefit from an increase in dose.

- < 40 kg: 20 mg every week
- ≥ 40 kg: 40 mg every week or 80 mg every other week

Continued therapy should be carefully considered in a subject not responding by Week 12.

There is no relevant use of adalimumab in children aged less than 6 years for this indication.

Hyrimoz may be available in other strengths and/or pharmaceutical forms depending on the individual treatment needs.

Paediatric ulcerative colitis

The recommended dose of Hyrimoz for patients from 6 to 17 years of age with ulcerative colitis is based on body weight (Table 5). Hyrimoz is administered via subcutaneous injection.

Table 5. Hyrimoz Dose for Paediatric Patients with Ulcerative Colitis

Patient Weight	Induction Dose	Maintenance Dose Starting at Week 4*
< 40 kg	<ul style="list-style-type: none"> • 80 mg at Week 0 (given as one 80 mg injection or two 40 mg injections in one day) and • 40 mg at Week 2 (given as one 40 mg injection) 	<ul style="list-style-type: none"> • 40 mg every other week
≥ 40 kg	<ul style="list-style-type: none"> • 160 mg at Week 0 (given as two 80 mg injections or four 40 mg injections in one day or one 80 mg injection or two 40 mg injections per day for two consecutive days) and • 80 mg at Week 2 (given as one 80 mg injection or two 40 mg injections in one day) 	<ul style="list-style-type: none"> • 80 mg every other week (given as one 80 mg injection or two 40 mg injections in one day)

* Paediatric patients who turn 18 years of age while on Hyrimoz should continue their prescribed maintenance dose.

Continued therapy beyond 8 weeks should be carefully considered in patients not showing signs of response within this time period.

There is no relevant use of Hyrimoz in children aged less than 6 years in this indication.

Hyrimoz may be available in different strengths and/or pharmaceutical forms depending on the individual treatment needs.

Paediatric uveitis

The recommended dose of Hyrimoz for paediatric patients with uveitis from 2 years of age is based on body weight (Table 6). Hyrimoz is administered via subcutaneous injection.

In paediatric uveitis, there is no experience in the treatment with adalimumab without concomitant treatment with methotrexate.

Table 6. Hyrimoz dose for paediatric patients with uveitis

Patient weight	Dosing regimen
< 30 kg	20 mg every other week in combination with methotrexate
≥ 30 kg	40 mg every other week in combination with methotrexate

When Hyrimoz therapy is initiated, a loading dose of 40 mg for patients < 30 kg or 80 mg for patients ≥ 30 kg may be administered one week prior to the start of maintenance therapy. No clinical data are available on the use of an adalimumab loading dose in children < 6 years of age (see section 5.2).

There is no relevant use of Hyrimoz in children aged less than 2 years in this indication.

It is recommended that the benefit and risk of continued long-term treatment should be

evaluated on a yearly basis (see section 5.1).

Hyrimoz may be available in other strengths and/or pharmaceutical forms depending on the individual treatment needs.

Method of administration

Hyrimoz is administered by subcutaneous injection.
Full instructions for use are provided in the package leaflet.

Adalimumab is available in other strengths and pharmaceutical forms.

4.3 Contraindications

Hypersensitivity to the active substance or to any of the excipients listed in section 6.1.

Active tuberculosis or other severe infections such as sepsis, and opportunistic infections (see section 4.4).

Moderate to severe heart failure (New York Heart Association (NYHA) class III/IV) (see section 4.4).

4.4 Special warnings and precautions for use

Traceability

In order to improve traceability of biological medicinal products, the name and the batch number of the administered product should be clearly recorded.

Infections

Patients taking TNF-antagonists are more susceptible to serious infections. Impaired lung function may increase the risk for developing infections. Patients must therefore be monitored closely for infections, including tuberculosis, before, during and after treatment with Hyrimoz. Because the elimination of adalimumab may take up to four months, monitoring should be continued throughout this period.

Treatment with Hyrimoz should not be initiated in patients with active infections including chronic or localised infections until infections are controlled. In patients who have been exposed to tuberculosis and patients who have travelled in areas of high risk of tuberculosis or endemic mycoses, such as histoplasmosis, coccidioidomycosis, or blastomycosis, the risk and benefits of treatment with Hyrimoz should be considered prior to initiating therapy (see *Other opportunistic infections*).

Patients who develop a new infection while undergoing treatment with Hyrimoz should be monitored closely and undergo a complete diagnostic evaluation. Administration of Hyrimoz should be discontinued if a patient develops a new serious infection or sepsis, and appropriate antimicrobial or antifungal therapy should be initiated until the infection is controlled. Physicians should exercise caution when considering the use of Hyrimoz in patients with a history of recurring infection or with underlying conditions which may predispose patients to infections, including the use of concomitant immunosuppressive medicinal products.

Serious infections

Serious infections, including sepsis, due to bacterial, mycobacterial, invasive fungal, parasitic, viral, or other opportunistic infections such as listeriosis, legionellosis and pneumocystis have been reported in patients receiving adalimumab.

Other serious infections seen in clinical studies include pneumonia, pyelonephritis, septic arthritis

and septicaemia. Hospitalisation or fatal outcomes associated with infections have been reported.

Tuberculosis

Tuberculosis, including reactivation and new onset of tuberculosis, has been reported in patients receiving adalimumab. Reports included cases of pulmonary and extra-pulmonary (i.e. disseminated) tuberculosis.

Before initiation of therapy with Hyrimoz, all patients must be evaluated for both active and inactive (“latent”) tuberculosis infection. This evaluation should include a detailed medical assessment of patient history of tuberculosis or possible previous exposure to people with active tuberculosis and previous and/or current immunosuppressive therapy. Appropriate screening tests (i.e. tuberculin skin test and chest X-ray) should be performed in all patients (local recommendations may apply). It is recommended that the conduct and results of these tests are recorded in the Patient Reminder Card. Prescribers are reminded of the risk of false negative tuberculin skin test results, especially in patients who are severely ill or immunocompromised.

If active tuberculosis is diagnosed, Hyrimoz therapy must not be initiated (see section 4.3).

In all situations described below, the benefit/risk balance of therapy should be very carefully considered.

If latent tuberculosis is suspected, a physician with expertise in the treatment of tuberculosis should be consulted.

If latent tuberculosis is diagnosed, appropriate treatment must be started with anti-tuberculosis prophylaxis treatment before the initiation of Hyrimoz, and in accordance with local recommendations.

Use of anti-tuberculosis prophylaxis treatment should also be considered before the initiation of Hyrimoz in patients with several or significant risk factors for tuberculosis despite a negative test for tuberculosis and in patients with a past history of latent or active tuberculosis in whom an adequate course of treatment cannot be confirmed.

Despite prophylactic treatment for tuberculosis, cases of reactivated tuberculosis have occurred in patients treated with adalimumab. Some patients who have been successfully treated for active tuberculosis have redeveloped tuberculosis while being treated with adalimumab.

Patients should be instructed to seek medical advice if signs/symptoms suggestive of a tuberculosis infection (e.g., persistent cough, wasting/weight loss, low grade fever, listlessness) occur during or after therapy with Hyrimoz.

Other opportunistic infections

Opportunistic infections, including invasive fungal infections have been observed in patients receiving adalimumab. These infections have not consistently been recognised in patients taking TNF-antagonists and this has resulted in delays in appropriate treatment, sometimes resulting in fatal outcomes.

For patients who develop the signs and symptoms such as fever, malaise, weight loss, sweats, cough, dyspnoea, and/or pulmonary infiltrates or other serious systemic illness with or without concomitant shock an invasive fungal infection should be suspected and administration of Hyrimoz should be promptly discontinued. Diagnosis and administration of empiric antifungal therapy in these patients should be made in consultation with a physician with expertise in the care of patients with invasive fungal infections.

Hepatitis B reactivation

Reactivation of hepatitis B has occurred in patients receiving a TNF-antagonist including adalimumab, who are chronic carriers of this virus (i.e. surface antigen positive). Some cases have had a fatal outcome. Patients should be tested for HBV infection before initiating treatment with Hyrimoz. For patients who test positive for hepatitis B infection, consultation with a physician with expertise in the treatment of hepatitis B is recommended.

Carriers of HBV who require treatment with Hyrimoz should be closely monitored for signs and symptoms of active HBV infection throughout therapy and for several months following termination of therapy. Adequate data from treating patients who are carriers of HBV with anti-viral therapy in conjunction with TNF-antagonist therapy to prevent HBV reactivation are not available. In patients who develop HBV reactivation, Hyrimoz should be stopped and effective anti-viral therapy with appropriate supportive treatment should be initiated.

Neurological events

TNF-antagonists including adalimumab have been associated in rare instances with new onset or exacerbation of clinical symptoms and/or radiographic evidence of central nervous system demyelinating disease including multiple sclerosis and optic neuritis, and peripheral demyelinating disease, including Guillain-Barré syndrome. Prescribers should exercise caution in considering the use of Hyrimoz in patients with pre-existing or recent-onset central or peripheral nervous system demyelinating disorders; discontinuation of Hyrimoz should be considered if any of these disorders develop. There is a known association between intermediate uveitis and central demyelinating disorders. Neurologic evaluation should be performed in patients with non-infectious intermediate uveitis prior to the initiation of Hyrimoz therapy and regularly during treatment to assess for pre-existing or developing central demyelinating disorders.

Allergic reactions

Serious allergic reactions associated with adalimumab were rare during clinical studies. Non-serious allergic reactions associated with adalimumab were uncommon during clinical studies. Reports of serious allergic reactions including anaphylaxis have been received following adalimumab administration. If an anaphylactic reaction or other serious allergic reaction occurs, administration of Hyrimoz should be discontinued immediately and appropriate therapy initiated.

Immunosuppression

In a study of 64 patients with rheumatoid arthritis that were treated with adalimumab, there was no evidence of depression of delayed-type hypersensitivity, depression of immunoglobulin levels, or change in enumeration of effector T-, B-, NK-cells, monocyte/macrophages, and neutrophils.

Malignancies and lymphoproliferative disorders

In the controlled portions of clinical studies of TNF-antagonists, more cases of malignancies including lymphoma have been observed among patients receiving a TNF-antagonist compared with control patients. However, the occurrence was rare. In the post marketing setting, cases of leukaemia have been reported in patients treated with a TNF-antagonist. There is an increased background risk for lymphoma and leukaemia in rheumatoid arthritis patients with long-standing, highly active, inflammatory disease, which complicates the risk estimation. With the current knowledge, a possible risk for the development of lymphomas, leukaemia, and other malignancies in patients treated with a TNF-antagonist cannot be excluded.

Malignancies, some fatal, have been reported among children, adolescents and young adults (up to 22 years of age) treated with TNF-antagonists (initiation of therapy \leq 18 years of age), including adalimumab in the post marketing setting. Approximately half the cases were lymphomas. The other

cases represented a variety of different malignancies and included rare malignancies usually associated with immunosuppression. A risk for the development of malignancies in children and adolescents treated with TNF-antagonists cannot be excluded.

Rare postmarketing cases of hepatosplenic T-cell lymphoma have been identified in patients treated with adalimumab. This rare type of T-cell lymphoma has a very aggressive disease course and is usually fatal. Some of these hepatosplenic T-cell lymphomas with adalimumab have occurred in young adult patients on concomitant treatment with azathioprine or 6-mercaptopurine used for inflammatory bowel disease. The potential risk with the combination of azathioprine or 6-mercaptopurine and Hyrimoz should be carefully considered. A risk for the development of hepatosplenic T-cell lymphoma in patients treated with Hyrimoz cannot be excluded (see section 4.8).

No studies have been conducted that include patients with a history of malignancy or in whom treatment with adalimumab is continued following development of malignancy. Thus additional caution should be exercised in considering Hyrimoz treatment of these patients (see section 4.8).

All patients, and in particular patients with a medical history of extensive immunosuppressant therapy or psoriasis patients with a history of PUVA treatment should be examined for the presence of non-melanoma skin cancer prior to and during treatment with Hyrimoz. Melanoma and Merkel cell carcinoma have also been reported in patients treated with TNF-antagonists including adalimumab (see section 4.8).

In an exploratory clinical study evaluating the use of another TNF-antagonist, infliximab, in patients with moderate to severe chronic obstructive pulmonary disease (COPD), more malignancies, mostly in the lung or head and neck, were reported in infliximab-treated patients compared with control patients. All patients had a history of heavy smoking. Therefore, caution should be exercised when using any TNF-antagonist in COPD patients, as well as in patients with increased risk for malignancy due to heavy smoking.

With current data it is not known if adalimumab treatment influences the risk for developing dysplasia or colon cancer. All patients with ulcerative colitis who are at increased risk for dysplasia or colon carcinoma (for example, patients with long-standing ulcerative colitis or primary sclerosing cholangitis), or who had a prior history of dysplasia or colon carcinoma should be screened for dysplasia at regular intervals before therapy and throughout their disease course. This evaluation should include colonoscopy and biopsies per local recommendations.

Haematologic reactions

Rare reports of pancytopenia including aplastic anaemia have been reported with TNF-antagonists. Adverse events of the haematologic system, including medically significant cytopenia (e.g. thrombocytopenia, leukopenia) have been reported with adalimumab. All patients should be advised to seek immediate medical attention if they develop signs and symptoms suggestive of blood dyscrasias (e.g. persistent fever, bruising, bleeding, pallor) while on Hyrimoz. Discontinuation of Hyrimoz therapy should be considered in patients with confirmed significant haematologic abnormalities.

Vaccinations

Similar antibody responses to the standard 23-valent pneumococcal vaccine and the influenza trivalent virus vaccination were observed in a study in 226 adult subjects with rheumatoid arthritis who were treated with adalimumab or placebo. No data are available on the secondary transmission of infection by live vaccines in patients receiving adalimumab.

It is recommended that paediatric patients, if possible, be brought up to date with all immunisations in agreement with current immunisation guidelines prior to initiating Hyrimoz therapy.

Patients on Hyrimoz may receive concurrent vaccinations, except for live vaccines. Administration of live vaccines (e.g., BCG vaccine) to infants exposed to adalimumab *in utero* is not recommended for 5 months following the mother's last adalimumab injection during pregnancy.

Congestive heart failure

In a clinical study with another TNF-antagonist worsening congestive heart failure and increased mortality due to congestive heart failure have been observed. Cases of worsening congestive heart failure have also been reported in patients receiving adalimumab. Hyrimoz should be used with caution in patients with mild heart failure (NYHA class I/II). Hyrimoz is contraindicated in moderate to severe heart failure (see section 4.3). Treatment with Hyrimoz must be discontinued in patients who develop new or worsening symptoms of congestive heart failure.

Autoimmune processes

Treatment with Hyrimoz may result in the formation of autoimmune antibodies. The impact of long-term treatment with adalimumab on the development of autoimmune diseases is unknown. If a patient develops symptoms suggestive of a lupus-like syndrome following treatment with Hyrimoz and is positive for antibodies against double-stranded DNA, further treatment with Hyrimoz should not be given (see section 4.8).

Concurrent administration of biologic DMARDs or TNF-antagonists

Serious infections were seen in clinical studies with concurrent use of anakinra and another TNF-antagonist, etanercept, with no added clinical benefit compared to etanercept alone. Because of the nature of the adverse events seen with the combination of etanercept and anakinra therapy, similar toxicities may also result from the combination of anakinra and other TNF-antagonists. Therefore, the combination of adalimumab and anakinra is not recommended (see section 4.5).

Concomitant administration of adalimumab with other biologic DMARDs (e.g, anakinra and abatacept) or other TNF-antagonists is not recommended based upon the possible increased risk for infections, including serious infections and other potential pharmacological interactions (see section 4.5).

Surgery

There is limited safety experience of surgical procedures in patients treated with adalimumab. The long half-life of adalimumab should be taken into consideration if a surgical procedure is planned. A patient who requires surgery while on Hyrimoz should be closely monitored for infections, and appropriate actions should be taken. There is limited safety experience in patients undergoing arthroplasty while receiving adalimumab.

Small bowel obstruction

Failure to respond to treatment for Crohn's disease may indicate the presence of fixed fibrotic stricture that may require surgical treatment. Available data suggest that adalimumab does not worsen or cause strictures.

Elderly

The frequency of serious infections among adalimumab-treated subjects over 65 years of age (3.7 %) was higher than for those under 65 years of age (1.5 %). Some of those had a fatal outcome. Particular attention regarding the risk for infection should be paid when treating the elderly.

Paediatric population

See Vaccinations above.

Sodium content

This medicinal product contains less than 1 mmol sodium (23 mg) per 0.8 ml, per 0.4 ml or per 0.2 ml dose, that is to say essentially ‘sodium-free’.

4.5 Interaction with other medicinal products and other forms of interaction

Adalimumab has been studied in rheumatoid arthritis, polyarticular juvenile idiopathic arthritis and psoriatic arthritis patients taking adalimumab as monotherapy and those taking concomitant methotrexate. Antibody formation was lower when adalimumab was given together with methotrexate in comparison with use as monotherapy. Administration of adalimumab without methotrexate resulted in increased formation of antibodies, increased clearance and reduced efficacy of adalimumab (see section 5.1).

The combination of adalimumab and anakinra is not recommended (see section 4.4 “Concurrent administration of biologic DMARDs or TNF-antagonists”).

The combination of adalimumab and abatacept is not recommended (see section 4.4 “Concurrent administration of biologic DMARDs or TNF-antagonists”).

4.6 Fertility, pregnancy and lactation

Women of childbearing potential

Women of childbearing potential should consider the use of adequate contraception to prevent pregnancy and continue its use for at least five months after the last Hyrimoz treatment.

Pregnancy

A large number (approximately 2 100) of prospectively collected pregnancies exposed to adalimumab resulting in live birth with known outcomes, including more than 1 500 exposed during the first trimester, does not indicate an increase in the rate of malformation in the newborn.

In a prospective cohort registry, 257 women with rheumatoid arthritis (RA) or Crohn’s disease (CD) treated with adalimumab at least during the first trimester and 120 women with RA or CD not treated with adalimumab were enrolled. The primary endpoint was the birth prevalence of major birth defects. The rate of pregnancies ending with at least one live born infant with a major birth defect was 6/69 (8.7 %) in the adalimumab-treated women with RA and 5/74 (6.8 %) in the untreated women with RA (unadjusted OR 1.31, 95 % CI 0.38–4.52) and 16/152 (10.5 %) in the adalimumab-treated women with CD and 3/32 (9.4 %) in the untreated women with CD (unadjusted OR 1.14, 95 % CI 0.31–4.16). The adjusted OR (accounting for baseline differences) was 1.10 (95 % CI 0.45–2.73) with RA and CD combined. There were no distinct differences between adalimumab-treated and untreated women for the secondary endpoints spontaneous abortions, minor birth defects, preterm delivery, birth size and serious or opportunistic infections and no stillbirths or malignancies were reported. The interpretation of data may be impacted due to methodological limitations of the study, including small sample size and non-randomized design.

In a developmental toxicity study conducted in monkeys, there was no indication of maternal toxicity, embryotoxicity or teratogenicity. Preclinical data on postnatal toxicity of adalimumab are not available (see section 5.3).

Due to its inhibition of TNF α , adalimumab administered during pregnancy could affect normal immune responses in the newborn. Adalimumab should only be used during pregnancy if clearly

needed.

Adalimumab may cross the placenta into the serum of infants born to women treated with adalimumab during pregnancy. Consequently, these infants may be at increased risk for infection. Administration of live vaccines (e.g., BCG vaccine) to infants exposed to adalimumab *in utero* is not recommended for 5 months following the mother's last adalimumab injection during pregnancy.

Breast-feeding

Limited information from the published literature indicates that adalimumab is excreted in breast milk at very low concentrations with the presence of adalimumab in human milk at concentrations of 0.1 % to 1 % of the maternal serum level. Given orally, immunoglobulin G proteins undergo intestinal proteolysis and have poor bioavailability. No effects on the breastfed newborns/infants are anticipated. Consequently, Hyrimoz can be used during breastfeeding.

Fertility

Preclinical data on fertility effects of adalimumab are not available.

4.7 Effects on ability to drive and use machines

Hyrimoz may have a minor influence on the ability to drive and use machines. Vertigo and visual impairment may occur following administration of Hyrimoz (see section 4.8).

4.8 Undesirable effects

Summary of the safety profile

Adalimumab was studied in 9 506 patients in pivotal controlled and open label studies for up to 60 months or more. These studies included rheumatoid arthritis patients with short term and long standing disease, juvenile idiopathic arthritis (polyarticular juvenile idiopathic arthritis and enthesitis-related arthritis) as well as axial spondyloarthritis (ankylosing spondylitis and axial spondyloarthritis without radiographic evidence of AS), psoriatic arthritis, Crohn's disease, ulcerative colitis, psoriasis, hidradenitis suppurativa and uveitis patients. The pivotal controlled studies involved 6 089 patients receiving adalimumab and 3 801 patients receiving placebo or active comparator during the controlled period.

The proportion of patients who discontinued treatment due to adverse events during the double-blind, controlled portion of pivotal studies was 5.9 % for patients taking adalimumab and 5.4 % for control-treated patients.

The most commonly reported adverse reactions are infections (such as nasopharyngitis, upper respiratory tract infection and sinusitis), injection site reactions (erythema, itching, haemorrhage, pain or swelling), headache and musculoskeletal pain.

Serious adverse reactions have been reported for adalimumab. TNF-antagonists, such as adalimumab affect the immune system and their use may affect the body's defence against infection and cancer.

Fatal and life-threatening infections (including sepsis, opportunistic infections and TB), HBV reactivation and various malignancies (including leukaemia, lymphoma and HSTCL) have also been reported with use of adalimumab.

Serious haematological, neurological and autoimmune reactions have also been reported. These include rare reports of pancytopenia, aplastic anaemia, central and peripheral demyelinating events and reports of lupus, lupus-related conditions and Stevens-Johnson syndrome.

Paediatric population

In general, the adverse events in paediatric patients were similar in frequency and type to those seen in adult patients.

Tabulated list of adverse reactions

The following list of adverse reactions is based on experience from clinical studies and on postmarketing experience and are displayed by system organ class (SOC) and frequency in Table 7 below: very common ($\geq 1/10$); common ($\geq 1/100$ to $< 1/10$); uncommon ($\geq 1/1\ 000$ to $< 1/100$); rare ($\geq 1/10\ 000$ to $< 1/1\ 000$); and not known (cannot be estimated from the available data). Within each frequency grouping, adverse reactions are presented in order of decreasing seriousness.

The highest frequency seen among the various indications has been included. An asterisk (*) appears in the SOC column if further information is found elsewhere in sections 4.3, 4.4 and 4.8.

Table 7. Adverse reactions

System Organ Class	Frequency	Adverse Reaction
Infections and infestations*	Very common	Respiratory tract infections (including lower and upper respiratory tract infection, pneumonia, sinusitis, pharyngitis, nasopharyngitis and pneumonia herpes viral)
	Common	Systemic infections (including sepsis, candidiasis and influenza), intestinal infections (including gastroenteritis viral), skin and soft tissue infections (including paronychia, cellulitis, impetigo, necrotising fasciitis and herpes zoster), ear infections, oral infections (including herpes simplex, oral herpes and tooth infections), reproductive tract infections (including vulvovaginal mycotic infection), urinary tract infections (including pyelonephritis), fungal infections, joint infections
	Uncommon	Neurological infections (including viral meningitis), opportunistic infections and tuberculosis (including coccidioidomycosis, histoplasmosis and mycobacterium avium complex infection), bacterial infections, eye infections, diverticulitis ¹⁾
Neoplasms benign, malignant and unspecified (including cysts and polyps)*	Common	Skin cancer excluding melanoma (including basal cell carcinoma and squamous cell carcinoma) benign neoplasm

System Organ Class	Frequency	Adverse Reaction
	Uncommon	Lymphoma**, solid organ neoplasm (including breast cancer, lung neoplasm and thyroid neoplasm), melanoma**
	Rare	Leukaemia ¹⁾
	Not known	Hepatosplenic T-cell lymphoma ¹⁾ Merkel cell carcinoma (neuroendocrine carcinoma of the skin) ¹⁾ Kaposi`s sarcoma
Blood and the lymphatic system disorders*	Very common	Leucopaenia (including neutropaenia and agranulocytosis), anaemia
	Common	Leucocytosis, thrombocytopaenia
	Uncommon	Idiopathic thrombocytopaenic purpura
	Rare	Pancytopaenia
Immune system disorders*	Common	Hypersensitivity, allergies (including seasonal allergy)
	Uncommon	Sarcoidosis ¹⁾ , vasculitis
	Rare	Anaphylaxis ¹⁾
Metabolism and nutrition disorders	Very common	Lipids increased
	Common	Hypokalaemia, uric acid increased, blood sodium abnormal, hypocalcaemia, hyperglycaemia, hypophosphataemia, dehydration
Psychiatric disorders	Common	Mood alterations (including depression), anxiety, insomnia
Nervous system disorders*	Very common	Headache
	Common	Paraesthesias (including hypoaesthesia), migraine, nerve root compression
	Uncommon	Cerebrovascular accident ¹⁾ , tremor, neuropathy

System Organ Class	Frequency	Adverse Reaction
	Rare	Multiple sclerosis, demyelinating disorders (e.g. optic neuritis, Guillain-Barré syndrome) ¹⁾
Eye disorders	Common	Visual impairment, conjunctivitis, blepharitis, eye swelling
	Uncommon	Diplopia
Ear and labyrinth disorders	Common	Vertigo
	Uncommon	Deafness, tinnitus
Cardiac disorders*	Common	Tachycardia
	Uncommon	Myocardial infarction ¹⁾ , arrhythmia, congestive heart failure
	Rare	Cardiac arrest
Vascular disorders	Common	Hypertension, flushing, haematoma
	Uncommon	Aortic aneurysm, vascular arterial occlusion, thrombophlebitis
Respiratory, thoracic and mediastinal disorders*	Common	Asthma, dyspnoea, cough
	Uncommon	Pulmonary embolism ¹⁾ , interstitial lung disease, chronic obstructive pulmonary disease, pneumonitis, pleural effusion ¹⁾
	Rare	Pulmonary fibrosis ¹⁾
Gastrointestinal disorders	Very common	Abdominal pain, nausea and vomiting
	Common	GI haemorrhage, dyspepsia, gastroesophageal reflux disease, sicca syndrome
	Uncommon	Pancreatitis, dysphagia, face oedema

System Organ Class	Frequency	Adverse Reaction
	Rare	Intestinal perforation ¹⁾
Hepato-biliary disorders*	Very common	Elevated liver enzymes
	Uncommon	Cholecystitis and cholelithiasis, hepatic steatosis, bilirubin increased
	Rare	Hepatitis, reactivation of hepatitis B ¹⁾ , autoimmune hepatitis ¹⁾
	Not known	Liver failure ¹⁾
Skin and subcutaneous tissue disorders	Very common	Rash (including exfoliative rash)
	Common	Worsening or new onset of psoriasis (including palmoplantar pustular psoriasis) ¹⁾ , urticaria, bruising (including purpura), dermatitis (including eczema), onychoclasia, hyperhidrosis, alopecia ¹⁾ , pruritus
	Uncommon	Night sweats, scar
	Rare	Erythema multiforme ¹⁾ , Stevens-Johnson syndrome ¹⁾ , angioedema ¹⁾ , cutaneous vasculitis ¹⁾ lichenoid skin reaction ¹⁾
	Not known	Worsening of symptoms of dermatomyositis ¹⁾
Musculoskeletal and connective tissue disorders	Very common	Musculoskeletal pain
	Common	Muscle spasms (including blood creatine phosphokinase increased)
	Uncommon	Rhabdomyolysis, systemic lupus erythematosus
	Rare	Lupus-like syndrome ¹⁾
Renal and urinary disorders	Common	Renal impairment, haematuria
	Uncommon	Nocturia
Reproductive system and breast disorders	Uncommon	Erectile dysfunction

System Organ Class	Frequency	Adverse Reaction
General disorders and administration site conditions*	Very common	Injection site reaction (including injection site erythema)
	Common	Chest pain, oedema, pyrexia ¹⁾
	Uncommon	Inflammation
Investigations*	Common	Coagulation and bleeding disorders (including activated partial thromboplastin time prolonged), autoantibody test positive (including double stranded DNA antibody), blood lactate dehydrogenase increased
	Not known	Weight increased ²⁾
Injury, poisoning and procedural complications	Common	Impaired healing

* further information is found elsewhere in sections 4.3, 4.4 and 4.8

** including open label extension studies

1) including spontaneous reporting data

2) The mean weight change from baseline for adalimumab ranged from 0.3 kg to 1.0 kg across adult indications compared to (minus) -0.4 kg to 0.4 kg for placebo over a treatment period of 4-6 months. Weight increase of 5-6 kg has also been observed in long-term extension studies with mean exposures of approximately 1-2 years without control group, particularly in patients with Crohn's disease and ulcerative colitis. The mechanism behind this effect is unclear but could be associated with the anti-inflammatory effect of adalimumab.

Hidradenitis suppurativa

The safety profile for patients with HS treated with adalimumab weekly was consistent with the known safety profile of adalimumab.

Uveitis

The safety profile for patients with uveitis treated with adalimumab every other week was consistent with the known safety profile of adalimumab.

Description of selected adverse reactions

Injection site reactions

In the pivotal controlled studies in adults and children, 12.9 % of patients treated with adalimumab developed injection site reactions (erythema and/or itching, haemorrhage, pain or swelling), compared to 7.2 % of patients receiving placebo or active control. Injection site reactions generally did not necessitate discontinuation of the medicinal product.

Infections

In the pivotal controlled studies in adults and children, the rate of infection was 1.51 per patient year in the adalimumab-treated patients and 1.46 per patient year in the placebo and active control-treated patients. The infections consisted primarily of nasopharyngitis, upper respiratory tract infection, and

sinusitis. Most patients continued on adalimumab after the infection resolved.

The incidence of serious infections was 0.04 per patient year in adalimumab-treated patients and 0.03 per patient year in placebo and active control-treated patients.

In controlled and open label adult and paediatric studies with adalimumab, serious infections (including fatal infections, which occurred rarely) have been reported, which include reports of tuberculosis (including miliary and extra-pulmonary locations) and invasive opportunistic infections (e.g. disseminated or extrapulmonary histoplasmosis, blastomycosis, coccidioidomycosis, pneumocystis, candidiasis, aspergillosis and listeriosis). Most of the cases of tuberculosis occurred within the first eight months after initiation of therapy and may reflect recrudescence of latent disease.

Malignancies and lymphoproliferative disorders

No malignancies were observed in 249 paediatric patients with an exposure of 655.6 patient years during adalimumab studies in patients with juvenile idiopathic arthritis (polyarticular juvenile idiopathic arthritis and enthesitis-related arthritis). In addition, no malignancies were observed in 192 paediatric patients with an exposure of 498.1 patient years during adalimumab studies in paediatric patients with Crohn's disease. No malignancies were observed in 77 paediatric patients with an exposure of 80.0 patient years during an adalimumab study in paediatric patients with chronic plaque psoriasis. No malignancies were observed in 93 paediatric patients with an exposure of 65.3 patient years during an adalimumab study in paediatric patients with ulcerative colitis. No malignancies were observed in 60 paediatric patients with an exposure of 58.4 patient years during an adalimumab study in paediatric patients with uveitis.

During the controlled portions of pivotal adalimumab studies in adults of at least 12 weeks in duration in patients with moderately to severely active rheumatoid arthritis, ankylosing spondylitis, axial spondyloarthritis without radiographic evidence of AS, psoriatic arthritis, psoriasis, hidradenitis suppurativa, Crohn's disease, ulcerative colitis and uveitis, malignancies, other than lymphoma and non-melanoma skin cancer, were observed at a rate (95 % confidence interval) of 6.8 (4.4, 10.5) per 1 000 patient years among 5 291 adalimumab-treated patients *versus* a rate of 6.3 (3.4, 11.8) per 1 000 patient years among 3 444 control patients (median duration of treatment was 4.0 months for adalimumab and 3.8 months for control-treated patients). The rate (95 % confidence interval) of non-melanoma skin cancers was 8.8 (6.0, 13.0) per 1 000 patient years among adalimumab-treated patients and 3.2 (1.3, 7.6) per 1 000 patient years among control patients. Of these skin cancers, squamous cell carcinomas occurred at rates (95 % confidence interval) of 2.7 (1.4, 5.4) per 1 000 patient years among adalimumab-treated patients and 0.6 (0.1, 4.5) per 1 000 patient years among control patients. The rate (95 % confidence interval) of lymphomas was 0.7 (0.2, 2.7) per 1 000 patient years among adalimumab-treated patients and 0.6 (0.1, 4.5) per 1 000 patient years among control patients.

When combining controlled portions of these studies and ongoing and completed open label extension studies with a median duration of approximately 3.3 years including 6 427 patients and over 26 439 patient years of therapy, the observed rate of malignancies, other than lymphoma and non-melanoma skin cancers is approximately 8.5 per 1 000 patient years. The observed rate of non-melanoma skin cancers is approximately 9.6 per 1 000 patient years, and the observed rate of lymphomas is approximately 1.3 per 1 000 patient years.

In post-marketing experience from January 2003 to December 2010, predominantly in patients with rheumatoid arthritis, the spontaneously reported rate of malignancies is approximately 2.7 per 1 000 patient treatment years. The spontaneously reported rates for non-melanoma skin cancers and lymphomas are approximately 0.2 and 0.3 per 1 000 patient treatment years, respectively (see section 4.4).

Rare post-marketing cases of hepatosplenic T-cell lymphoma have been reported in patients treated with adalimumab (see section 4.4).

Autoantibodies

Patients had serum samples tested for autoantibodies at multiple time points in rheumatoid arthritis studies I–V. In these studies, 11.9 % of patients treated with adalimumab and 8.1 % of placebo and active control-treated patients that had negative baseline anti-nuclear antibody titres reported positive titres at Week 24. Two patients out of 3 441 treated with adalimumab in all rheumatoid arthritis and psoriatic arthritis studies developed clinical signs suggestive of new-onset lupus-like syndrome. The patients improved following discontinuation of therapy. No patients developed lupus nephritis or central nervous system symptoms.

Hepato-biliary events

In controlled Phase 3 studies of adalimumab in patients with rheumatoid arthritis and psoriatic arthritis with a control period duration ranging from 4 to 104 weeks, ALT elevations ≥ 3 x ULN occurred in 3.7 % of adalimumab-treated patients and 1.6 % of control-treated patients.

In controlled Phase 3 studies of adalimumab in patients with polyarticular juvenile idiopathic arthritis who were 4 to 17 years and enthesitis-related arthritis who were 6 to 17 years, ALT elevations ≥ 3 x ULN occurred in 6.1 % of adalimumab-treated patients and 1.3 % of control-treated patients. Most ALT elevations occurred with concomitant methotrexate use. No ALT elevations ≥ 3 x ULN occurred in the Phase 3 study of adalimumab in patients with polyarticular juvenile idiopathic arthritis who were 2 to < 4 years.

In controlled Phase 3 studies of adalimumab in patients with Crohn's disease and ulcerative colitis with a control period ranging from 4 to 52 weeks. ALT elevations ≥ 3 x ULN occurred in 0.9 % of adalimumab-treated patients and 0.9 % of controlled-treated patients.

In the Phase 3 study of adalimumab in patients with paediatric Crohn's disease which evaluated efficacy and safety of two body weight adjusted maintenance dose regimens following body weight adjusted induction therapy up to 52 weeks of treatment, ALT elevations ≥ 3 x ULN occurred in 2.6 % (5/192) of patients of whom 4 were receiving concomitant immunosuppressants at baseline.

In controlled Phase 3 studies of adalimumab in patients with plaque Psoriasis with a control period duration ranging from 12 to 24 weeks, ALT elevations ≥ 3 x ULN occurred in 1.8 % of adalimumab-treated patients and 1.8 % of control-treated patients.

No ALT elevations ≥ 3 x ULN occurred in the Phase 3 study of adalimumab in paediatric patients with plaque psoriasis.

In controlled studies of adalimumab (initial doses of 160 mg at Week 0 and 80 mg at Week 2, followed by 40 mg every week starting at Week 4), in patients with hidradenitis suppurativa with a control period duration ranging from 12 to 16 weeks, ALT elevations ≥ 3 x ULN occurred in 0.3 % of adalimumab-treated patients and 0.6 % of control-treated patients.

In controlled studies of adalimumab (initial doses of 80 mg at Week 0 followed by 40 mg every other week starting at Week 1) in adult patients with uveitis up to 80 weeks with a median exposure of 166.5 days and 105.0 days in adalimumab-treated and control-treated patients, respectively, ALT elevations ≥ 3 x ULN occurred in 2.4 % of adalimumab-treated patients and 2.4 % of control-treated patients.

In the controlled Phase 3 study of adalimumab in patients with paediatric ulcerative colitis (N=93) which evaluated efficacy and safety of a maintenance dose of 0.6 mg/kg (maximum of 40 mg) every other week (N=31) and a maintenance dose of 0.6 mg/kg (maximum of 40 mg) every week (N=32), following body weight adjusted induction dosing of 2.4 mg/kg (maximum of 160 mg) at Week 0 and Week 1, and 1.2 mg/kg (maximum of 80 mg) at Week 2 (N=63), or an induction dose of 2.4 mg/kg

(maximum of 160 mg) at Week 0, placebo at Week 1, and 1.2 mg/kg (maximum of 80 mg) at Week 2 (N=30), ALT elevations $\geq 3 \times$ ULN occurred in 1.1 % (1/93) of patients.

Across all indications in clinical studies patients with raised ALT were asymptomatic and in most cases elevations were transient and resolved on continued treatment. However, there have also been post-marketing reports of liver failure as well as less severe liver disorders that may precede liver failure, such as hepatitis including autoimmune hepatitis in patients receiving adalimumab.

Concurrent treatment with azathioprine/6-mercaptopurine

In adult Crohn's disease studies, higher incidences of malignant and serious infection-related adverse events were seen with the combination of adalimumab and azathioprine/6-mercaptopurine compared with adalimumab alone.

Reporting of suspected adverse reactions

Reporting suspected adverse reactions after authorisation of the medicinal product is important. It allows continued monitoring of the benefit/risk balance of the medicinal product. Healthcare professionals are asked to report any suspected adverse reactions via the national reporting system listed in [Appendix V](#).

4.9 Overdose

No dose-limiting toxicity was observed during clinical studies. The highest dose level evaluated has been multiple intravenous doses of 10 mg/kg, which is approximately 15 times the recommended dose.

5. PHARMACOLOGICAL PROPERTIES

5.1 Pharmacodynamic properties

Pharmacotherapeutic group: Immunosuppressants, Tumour Necrosis Factor alpha (TNF- α) inhibitors, ATC code: L04AB04

Hyrimoz is a biosimilar medicinal product. Detailed information is available on the website of the European Medicines Agency <https://www.ema.europa.eu>.

Mechanism of action

Adalimumab binds specifically to TNF and neutralises the biological function of TNF by blocking its interaction with the p55 and p75 cell surface TNF receptors.

Adalimumab also modulates biological responses that are induced or regulated by TNF, including changes in the levels of adhesion molecules responsible for leukocyte migration (ELAM-1, VCAM-1, and ICAM-1 with an IC_{50} of 0.1–0.2 nM).

Pharmacodynamic effects

After treatment with adalimumab, a rapid decrease in levels of acute phase reactants of inflammation (C-reactive protein (CRP) and erythrocyte sedimentation rate (ESR)) and serum cytokines (IL-6) was observed, compared to baseline in patients with rheumatoid arthritis. Serum levels of matrix metalloproteinases (MMP-1 and MMP-3) that produce tissue remodelling responsible for cartilage destruction were also decreased after adalimumab administration. Patients treated with adalimumab usually experienced improvement in haematological signs of chronic inflammation.

A rapid decrease in CRP levels was also observed in patients with polyarticular juvenile idiopathic arthritis, Crohn's disease, ulcerative colitis and hidradenitis suppurativa after treatment with adalimumab. In patients with Crohn's disease, a reduction of the number of cells expressing

inflammatory markers in the colon including a significant reduction of expression of TNF- α was seen. Endoscopic studies in intestinal mucosa have shown evidence of mucosal healing in adalimumab-treated patients.

Clinical efficacy and safety

Rheumatoid arthritis

Adalimumab was evaluated in over 3 000 patients in all rheumatoid arthritis clinical studies. The efficacy and safety of adalimumab were assessed in five randomised, double-blind and well-controlled studies. Some patients were treated for up to 120 months duration.

RA study I evaluated 271 patients with moderately to severely active rheumatoid arthritis who were \geq 18 years old, had failed therapy with at least one disease-modifying, anti-rheumatic drug and had insufficient efficacy with methotrexate at doses of 12.5 to 25 mg (10 mg if methotrexate-intolerant) every week and whose methotrexate dose remained constant at 10 to 25 mg every week. Doses of 20, 40 or 80 mg of adalimumab or placebo were given every other week for 24 weeks.

RA study II evaluated 544 patients with moderately to severely active rheumatoid arthritis who were \geq 18 years old and had failed therapy with at least one disease-modifying, anti-rheumatic drugs. Doses of 20 or 40 mg of adalimumab were given by subcutaneous injection every other week with placebo on alternative weeks or every week for 26 weeks; placebo was given every week for the same duration. No other disease-modifying anti-rheumatic drugs were allowed.

RA study III evaluated 619 patients with moderately to severely active rheumatoid arthritis who were \geq 18 years old, and who had an ineffective response to methotrexate at doses of 12.5 to 25 mg or have been intolerant to 10 mg of methotrexate every week. There were three groups in this study. The first received placebo injections every week for 52 weeks. The second received 20 mg of adalimumab every week for 52 weeks. The third group received 40 mg of adalimumab every other week with placebo injections on alternate weeks. Upon completion of the first 52 weeks, 457 patients enrolled in an open-label extension phase in which 40 mg of adalimumab/MTX was administered every other week up to 10 years.

RA study IV primarily assessed safety in 636 patients with moderately to severely active rheumatoid arthritis who were \geq 18 years old. Patients were permitted to be either disease-modifying, anti-rheumatic drug-naïve or to remain on their pre-existing rheumatologic therapy provided that therapy was stable for a minimum of 28 days. These therapies include methotrexate, leflunomide, hydroxychloroquine, sulfasalazine and/or gold salts. Patients were randomised to 40 mg of adalimumab or placebo every other week for 24 weeks.

RA study V evaluated 799 methotrexate-naïve, adult patients with moderate to severely active early rheumatoid arthritis (mean disease duration less than 9 months). This study evaluated the efficacy of adalimumab 40 mg every other week/methotrexate combination therapy, adalimumab 40 mg every other week monotherapy and methotrexate monotherapy in reducing the signs and symptoms and rate of progression of joint damage in rheumatoid arthritis for 104 weeks. Upon completion of the first 104 weeks, 497 patients enrolled in an open-label extension phase in which 40 mg of adalimumab was administered every other week up to 10 years.

The primary end point in RA studies I, II and III and the secondary endpoint in RA study IV was the percent of patients who achieved an ACR 20 response at Week 24 or 26. The primary endpoint in RA study V was the percent of patients who achieved an ACR 50 response at Week 52. RA studies III and V had an additional primary endpoint at 52 weeks of retardation of disease progression (as detected by X-ray results). RA study III also had a primary endpoint of changes in quality of life.

ACR response

The percent of adalimumab-treated patients achieving ACR 20, 50 and 70 responses was consistent

across RA studies I, II and III. The results for the 40 mg every other week dose are summarised in Table 8.

**Table 8. ACR responses in placebo-controlled studies
(percent of patients)**

response	RA Study I ^{a**}		RA Study II ^{a**}		RA Study III ^{a**}	
	placebo/MTX ^c n = 60	adalimumab ^b /M TX ^c n = 63	placebo n = 110	adalimumab ^b n = 113	placebo/MTX ^c n = 200	adalimumab ^b /M TX ^c n = 207
ACR 20						
6 months	13.3 %	65.1 %	19.1 %	46.0 %	29.5 %	63.3 %
12 months	NA	NA	NA	NA	24.0 %	58.9 %
ACR 50						
6 months	6.7 %	52.4 %	8.2 %	22.1 %	9.5 %	39.1 %
12 months	NA	NA	NA	NA	9.5 %	41.5 %
ACR 70						
6 months	3.3 %	23.8 %	1.8 %	12.4 %	2.5 %	20.8 %
12 months	NA	NA	NA	NA	4.5 %	23.2 %

^a RA study I at 24 weeks, RA study II at 26 weeks, and RA study III at 24 and 52 weeks

^b 40 mg adalimumab administered every other week

^c MTX = methotrexate

** p < 0.01, adalimumab *versus* placebo

In RA studies I–IV, all individual components of the ACR response criteria (number of tender and swollen joints, physician and patient assessment of disease activity and pain, disability index (HAQ) scores and CRP (mg/dl) values) improved at 24 or 26 weeks compared to placebo. In RA study III, these improvements were maintained throughout 52 weeks.

In the open-label extension for RA study III, most patients who were ACR responders maintained response when followed for up to 10 years. Of 207 patients who were randomised to adalimumab 40 mg every other week, 114 patients continued on adalimumab 40 mg every other week for 5 years. Among those, 86 patients (75.4 %) had ACR 20 responses; 72 patients (63.2 %) had ACR 50 responses; and 41 patients (36 %) had ACR 70 responses. Of 207 patients, 81 patients continued on adalimumab 40 mg every other week for 10 years. Among those, 64 patients (79.0 %) had ACR 20 responses; 56 patients (69.1 %) had ACR 50 responses; and 43 patients (53.1 %) had ACR 70 responses.

In RA study IV, the ACR 20 response of patients treated with adalimumab plus standard of care was statistically significantly better than patients treated with placebo plus standard of care (p < 0.001).

In RA studies I–IV, adalimumab-treated patients achieved statistically significant ACR 20 and 50 responses compared to placebo as early as one to two weeks after initiation of treatment.

In RA study V with early rheumatoid arthritis patients who were methotrexate naïve, combination therapy with adalimumab and methotrexate led to faster and significantly greater ACR responses than methotrexate monotherapy and adalimumab monotherapy at Week 52 and responses were sustained at Week 104 (see Table 9).

**Table 9. ACR responses in RA study V
(percent of patients)**

response	MTX n = 257	adalimumab n = 274	adalimumab/MT X n = 268	p-value ^a	p-value ^b	p-value ^c
ACR 20						
Week 52	62.6 %	54.4 %	72.8 %	0.013	< 0.001	0.043
Week 104	56.0 %	49.3 %	69.4 %	0.002	< 0.001	0.140
ACR 50						
Week 52	45.9 %	41.2 %	61.6 %	< 0.001	< 0.001	0.317
Week 104	42.8 %	36.9 %	59.0 %	< 0.001	< 0.001	0.162
ACR 70						
Week 52	27.2 %	25.9 %	45.5 %	< 0.001	< 0.001	0.656
Week 104	28.4 %	28.1 %	46.6 %	< 0.001	< 0.001	0.864

^a p-value is from the pairwise comparison of methotrexate monotherapy and adalimumab/methotrexate combination therapy using the Mann-Whitney U test.

^b p-value is from the pairwise comparison of adalimumab monotherapy and adalimumab/methotrexate combination therapy using the Mann-Whitney U test

^c p-value is from the pairwise comparison of adalimumab monotherapy and methotrexate monotherapy using the Mann-Whitney U test

In the open-label extension for RA study V, ACR response rates were maintained when followed for up to 10 years. Of 542 patients who were randomised to adalimumab 40 mg every other week, 170 patients continued on adalimumab 40 mg every other week for 10 years. Among those, 154 patients (90.6 %) had ACR 20 responses; 127 patients (74.7 %) had ACR 50 responses; and 102 patients (60.0 %) had ACR 70 responses.

At Week 52, 42.9 % of patients who received adalimumab/methotrexate combination therapy achieved clinical remission (DAS28 < 2.6) compared to 20.6 % of patients receiving methotrexate monotherapy and 23.4 % of patients receiving adalimumab monotherapy.

Adalimumab/methotrexate combination therapy was clinically and statistically superior to methotrexate ($p < 0.001$) and adalimumab monotherapy ($p < 0.001$) in achieving a low disease state in patients with recently diagnosed moderate to severe rheumatoid arthritis. The response for the two monotherapy arms was similar ($p = 0.447$).

Of 342 subjects originally randomized to adalimumab monotherapy or adalimumab/methotrexate combination therapy who entered the open-label extension study, 171 subjects completed 10 years of adalimumab treatment. Among those, 109 subjects (63.7 %) were reported to be in remission at 10 years.

Radiographic response

In RA study III, where adalimumab-treated patients had a mean duration of rheumatoid arthritis of approximately 11 years, structural joint damage was assessed radiographically and expressed as change in modified Total Sharp Score (TSS) and its components, the erosion score and joint space narrowing score. Adalimumab/methotrexate patients demonstrated significantly less radiographic progression than patients receiving methotrexate alone at 6 and 12 months (see

Table 10).

In the open-label extension of RA Study III, the reduction in rate of progression of structural damage is maintained for 8 and 10 years in a subset of patients. At 8 years, 81 of 207 patients originally treated with 40 mg adalimumab every other week were evaluated radiographically. Among those, 48 patients showed no progression of structural damage defined by a change from baseline in the mTSS of 0.5 or less. At 10 years, 79 of 207 patients originally treated with 40 mg adalimumab every other week were evaluated radiographically. Among those, 40 patients showed no progression of structural damage defined by a change from baseline in the mTSS of 0.5 or less.

Table 10. Radiographic mean changes over 12 months in RA study III

	placebo/MTX ^a	adalimumab/MTX 40 mg every other week	placebo/MTX- adalimumab/MTX (95 % confidence interval ^b)	p-value
total Sharp score	2.7	0.1	2.6 (1.4, 3.8)	< 0.001 ^c
erosion score	1.6	0.0	1.6 (0.9, 2.2)	< 0.001
JSN ^d score	1.0	0.1	0.9 (0.3, 1.4)	0.002

^a methotrexate

^b 95 % confidence intervals for the differences in change scores between methotrexate and adalimumab

^c based on rank analysis

^d Joint Space Narrowing

In RA study V, structural joint damage was assessed radiographically and expressed as change in modified total Sharp Score (see Table 11).

Table 11. Radiographic mean changes at Week 52 in RA study V

	MTX n = 257 (95 % confidence interval)	adalimumab n = 274 (95 % confidence interval)	adalimumab/M TX n=268 (95 % confidence interval)	p-value ^a	p-value ^b	p-value ^c
total Sharp score	5.7 (4.2–7.3)	3.0 (1.7–4.3)	1.3 (0.5–2.1)	< 0.001	0.0020	< 0.001
erosion score	3.7 (2.7–4.7)	1.7 (1.0–2.4)	0.8 (0.4–1.2)	< 0.001	0.0082	< 0.001
JSN score	2.0 (1.2–2.8)	1.3 (0.5–2.1)	0.5 (0–1.0)	< 0.001	0.0037	0.151

^a p-value is from the pairwise comparison of methotrexate monotherapy and adalimumab/methotrexate combination therapy using the Mann-Whitney U test.

^b p-value is from the pairwise comparison of adalimumab monotherapy and adalimumab/methotrexate combination therapy using the Mann-Whitney U test

^c p-value is from the pairwise comparison of adalimumab monotherapy and methotrexate monotherapy using the Mann-Whitney U test

Following 52 weeks and 104 weeks of treatment, the percentage of patients without progression (change from baseline in modified Total Sharp Score \leq 0.5) was significantly higher with adalimumab/methotrexate combination therapy (63.8 % and 61.2 % respectively) compared to methotrexate monotherapy (37.4 % and 33.5 % respectively, $p < 0.001$) and adalimumab monotherapy

(50.7 %, $p < 0.002$ and 44.5 %, $p < 0.001$ respectively).

In the open-label extension of RA study V, the mean change from baseline at Year 10 in the modified Total Sharp Score was 10.8, 9.2 and 3.9 in patients originally randomised to methotrexate monotherapy, adalimumab monotherapy and adalimumab/methotrexate combination therapy, respectively. The corresponding proportions of patients with no radiographic progression were 31.3 %, 23.7 % and 36.7 % respectively.

Quality of life and physical function

Health-related quality of life and physical function were assessed using the disability index of the Health Assessment Questionnaire (HAQ) in the four original adequate and well-controlled studies, which was a pre-specified primary endpoint at Week 52 in RA study III. All doses/schedules of adalimumab in all four studies showed statistically significantly greater improvement in the disability index of the HAQ from baseline to Month 6 compared to placebo and in RA study III the same was seen at Week 52. Results from the Short Form Health Survey (SF 36) for all doses/schedules of adalimumab in all four studies support these findings, with statistically significant physical component summary (PCS) scores, as well as statistically significant pain and vitality domain scores for the 40 mg every other week dose. A statistically significant decrease in fatigue as measured by functional assessment of chronic illness therapy (FACIT) scores was seen in all three studies in which it was assessed (RA studies I, III, IV).

In RA study III, most subjects who achieved improvement in physical function and continued treatment maintained improvement through Week 520 (120 months) of open-label treatment. Improvement in quality of life was measured up to Week 156 (36 months) and improvement was maintained through that time.

In RA study V, the improvement in the HAQ disability index and the physical component of the SF 36 showed greater improvement ($p < 0.001$) for adalimumab/methotrexate combination therapy *versus* methotrexate monotherapy and adalimumab monotherapy at Week 52, which was maintained through Week 104. Among the 250 subjects who completed the open-label extension study, improvements in physical function were maintained through 10 years of treatment.

Axial spondyloarthritis

Ankylosing spondylitis (AS)

Adalimumab 40 mg every other week was assessed in 393 patients in two randomised, 24 week double-blind, placebo-controlled studies in patients with active ankylosing spondylitis (mean baseline score of disease activity [Bath Ankylosing Spondylitis Disease Activity Index (BASDAI)] was 6.3 in all groups) who have had an inadequate response to conventional therapy. Seventy-nine (20.1 %) patients were treated concomitantly with disease modifying anti-rheumatic drugs, and 37 (9.4 %) patients with glucocorticoids. The blinded period was followed by an open-label period during which patients received adalimumab 40 mg every other week subcutaneously for up to an additional 28 weeks. Subjects ($n = 215$, 54.7 %) who failed to achieve ASAS 20 at Weeks 12, or 16 or 20 received early escape open-label adalimumab 40 mg every other week subcutaneously and were subsequently treated as non-responders in the double-blind statistical analyses.

In the larger AS study I with 315 patients, results showed statistically significant improvement of the signs and symptoms of ankylosing spondylitis in patients treated with adalimumab compared to placebo. Significant response was first observed at Week 2 and maintained through 24 weeks (Table 12).

**Table 12. Efficacy responses in placebo-controlled AS study – study I
reduction of signs and symptoms**

response	placebo N=107	adalimumab N=208
ASAS ^a 20		
Week 2	16 %	42 %***
Week 12	21 %	58 %***
Week 24	19 %	51 %***
ASAS 50		
Week 2	3 %	16 %***
Week 12	10 %	38 %***
Week 24	11 %	35 %***
ASAS 70		
Week 2	0 %	7 %**
Week 12	5 %	23 %***
Week 24	8 %	24 %***
BASDAI ^b 50		
Week 2	4 %	20 %***
Week 12	16 %	45 %***
Week 24	15 %	42 %***

***, ** statistically significant at $p < 0.001$, < 0.01 for all comparisons between adalimumab and placebo at Weeks 2, 12 and 24

^a assessments in ankylosing spondylitis

^b Bath ankylosing spondylitis disease activity index

Adalimumab-treated patients had significantly greater improvement at Week 12 which was maintained through Week 24 in both the SF36 and Ankylosing Spondylitis Quality of Life Questionnaire (ASQoL).

Similar trends (not all statistically significant) were seen in the smaller randomised, double-blind, placebo-controlled AS study II of 82 adult patients with active ankylosing spondylitis.

Axial spondyloarthritis without radiographic evidence of AS

The safety and efficacy of adalimumab were assessed in two randomized, double-blind placebo-controlled studies in patients with non-radiographic axial spondyloarthritis (nr-axSpA). Study nr-axSpA I evaluated patients with active nr-axSpA. Study nr-axSpA II was a treatment withdrawal study in active nr-axSpA patients who achieved remission during open-label treatment with adalimumab.

Study nr-axSpA I

In study nr-axSpA I, adalimumab 40 mg every other week was assessed in 185 patients in a randomised, 12 week double-blind, placebo-controlled study in patients with active nr-axSpA (mean baseline score of disease activity [Bath Ankylosing Spondylitis Disease Activity Index (BASDAI)] was 6.4 for patients treated with adalimumab and 6.5 for those on placebo) who have had an inadequate response to or intolerance to ≥ 1 NSAIDs, or a contraindication for NSAIDs.

Thirty-three (18 %) patients were treated concomitantly with disease modifying anti-rheumatic drugs, and 146 (79 %) patients with NSAIDs at baseline. The double-blind period was followed by an open-label period during which patients receive adalimumab 40 mg every other week subcutaneously for up

to an additional 144 weeks. Week 12 results showed statistically significant improvement of the signs and symptoms of active nr-axSpA in patients treated with adalimumab compared to placebo (Table 13).

Table 13. Efficacy response in placebo-controlled study nr-axSpA I

double-blind response at Week 12	placebo N=94	adalimumab N=91
ASAS ^a 40	15 %	36 %***
ASAS 20	31 %	52 %**
ASAS 5/6	6 %	31 %***
ASAS partial remission	5 %	16 %*
BASDAI ^b 50	15 %	35 %**
ASDAS ^{c,d,e}	-0.3	-1.0***
ASDAS inactive disease	4 %	24 %***
hs-CRP ^{d,f,g}	-0.3	-4.7***
SPARCC ^h MRI sacroiliac joints ^{d,i}	-0.6	-3.2**
SPARCC MRI spine ^{d,j}	-0.2	-1.8**

^a assessment of SpondyloArthritis International Society

^b Bath ankylosing spondylitis disease activity index

^c ankylosing spondylitis disease activity score

^d mean change from baseline

^e n=91 placebo and n=87 adalimumab

^f high sensitivity C-Reactive Protein (mg/L)

^g n=73 placebo and n=70 adalimumab

^h Spondyloarthritis Research Consortium of Canada

ⁱ n=84 placebo and adalimumab

^j n=82 placebo and n=85 adalimumab

***, **, * statistically significant at $p < 0.001$, < 0.01 , and < 0.05 , respectively, for all comparisons between adalimumab and placebo.

In the open-label extension, improvement in the signs and symptoms was maintained with adalimumab therapy through Week 156.

Inhibition of inflammation

Significant improvement of signs of inflammation as measured by hs-CRP and MRI of both Sacroiliac Joints and the Spine was maintained in adalimumab-treated patients through Week 156 and Week 104, respectively.

Quality of life and physical function

Health-related quality of life and physical function were assessed using the HAQ-S and the SF-36 questionnaires. Adalimumab showed statistically significantly greater improvement in the HAQ-S total score and the SF-36 Physical Component Score (PCS) from baseline to Week 12 compared to placebo. Improvement in health-related quality of life and physical function was maintained during the open-label extension through Week 156.

Study nr-axSpA II

673 patients with active nr-axSpA (mean baseline disease activity [BASDAI] was 7.0) who had an inadequate response to ≥ 2 NSAIDs, or an intolerance to or a contraindication for NSAIDs enrolled into the open-label period of Study nr-axSpA II during which they received adalimumab 40 mg eow

for 28 weeks. These patients also had objective evidence of inflammation in the sacroiliac joints or spine on MRI or elevated hs-CRP. Patients who achieved sustained remission for at least 12 weeks (N=305) (ASDAS < 1.3 at Weeks 16, 20, 24, and 28) during the open-label period were then randomized to receive either continued treatment with adalimumab 40 mg eow (N=152) or placebo (N=153) for an additional 40 weeks in a double-blind, placebo-controlled period (total study duration 68 weeks). Subjects who flared during the double-blind period were allowed adalimumab 40 mg eow rescue therapy for at least 12 weeks.

The primary efficacy endpoint was the proportion of patients with no flare by Week 68 of the study. Flare was defined as ASDAS \geq 2.1 at two consecutive visits four weeks apart. A greater proportion of patients on adalimumab had no disease flare during the double-blind period, when compared with those on placebo (70.4 % vs. 47.1 %, $p < 0.001$) (Figure 1).

Figure 1: Kaplan-Meier Curves summarizing time to flare in study nr-axSpA II

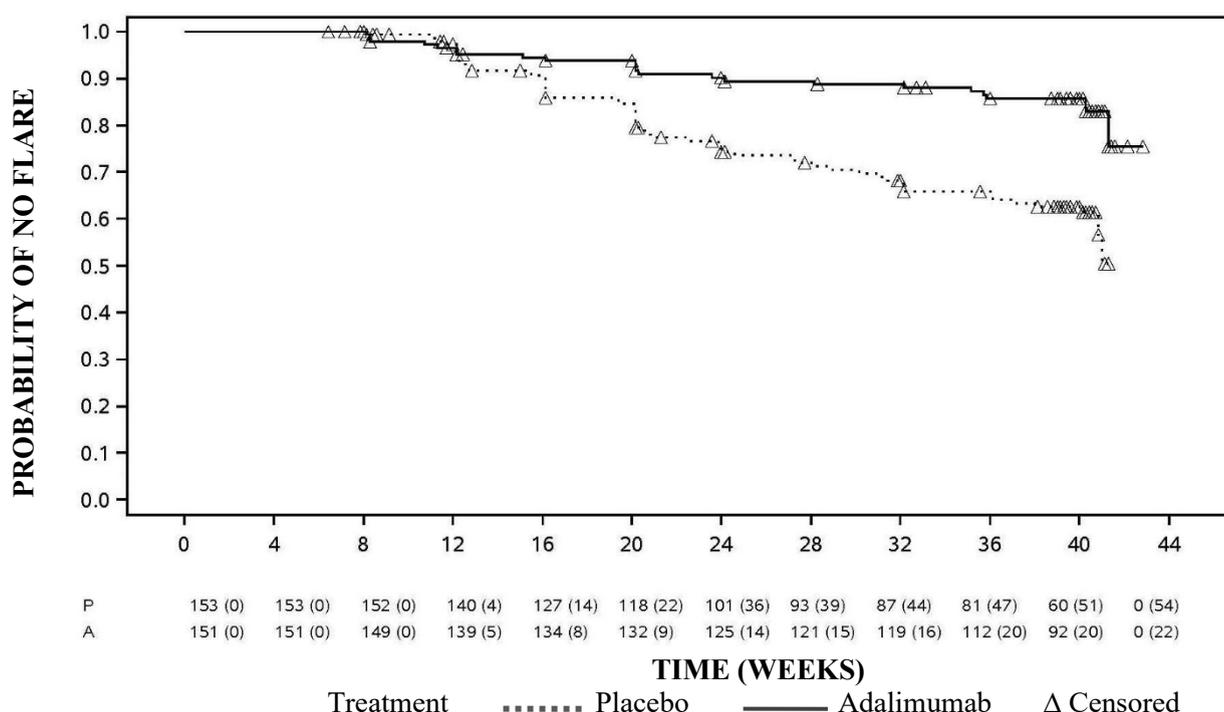

Note: P = Placebo (Number at Risk (flared)); A = Adalimumab (Number at Risk (flared)).

Among the 68 patients who flared in the group allocated to treatment withdrawal, 65 completed 12 weeks of rescue therapy with adalimumab, out of which 37 (56.9 %) had regained remission (ASDAS < 1.3) after 12 weeks of restarting the open-label treatment.

By Week 68, patients receiving continuous adalimumab treatment showed statistically significant greater improvement of the signs and symptoms of active nr-axSpA as compared to patients allocated to treatment withdrawal during the double-blind period of the study (Table 14).

Table 14. Efficacy response in placebo-controlled period for study nr-axSpA II

double-blind response at Week 68	placebo N=153	adalimumab N=152
ASAS ^{a,b} 20	47.1 %	70.4 %***
ASAS ^{a,b} 40	45.8 %	65.8 %***
ASAS ^a partial remission	26.8 %	42.1 %**
ASDAS ^c inactive disease	33.3 %	57.2 %***
partial flare ^d	64.1 %	40.8 %***

^a assessment of SpondyloArthritis International Society

^b baseline is defined as open label baseline when patients have active disease.

^c Ankylosing Spondylitis Disease Activity Score

^d partial flare is defined as ASDAS \geq 1.3 but $<$ 2.1 at 2 consecutive visits.

***, ** statistically significant at $p < 0.001$ and < 0.01 , respectively, for all comparisons between adalimumab and placebo.

Psoriatic arthritis

Adalimumab, 40 mg every other week, was studied in patients with moderately to severely active psoriatic arthritis in two placebo-controlled studies, PsA studies I and II. PsA study I with 24 week duration, treated 313 adult patients who had an inadequate response to non-steroidal anti-inflammatory drug therapy and of these, approximately 50 % were taking methotrexate. PsA study II with 12-week duration, treated 100 patients who had an inadequate response to DMARD therapy. Upon completion of both studies, 383 patients enrolled in an open-label extension study, in which 40 mg adalimumab was administered every other week (eow).

There is insufficient evidence of the efficacy of adalimumab in patients with ankylosing spondylitis-like psoriatic arthropathy due to the small number of patients studied.

Table 15. ACR response in placebo-controlled psoriatic arthritis studies (percent of patients)

response	PsA study I		PsA study II	
	placebo N=162	adalimumab N=151	placebo N=49	adalimumab N=51
ACR 20				
Week 12	14 %	58 %***	16 %	39 %*
Week 24	15 %	57 %***	N/A	N/A
ACR 50				
Week 12	4 %	36 %***	2 %	25 %***
Week 24	6 %	39 %***	N/A	N/A
ACR 70				
Week 12	1 %	20 %***	0 %	14 %*
Week 24	1 %	23 %***	N/A	N/A

*** $p < 0.001$ for all comparisons between adalimumab and placebo

* $p < 0.05$ for all comparisons between adalimumab and placebo

N/A not applicable

ACR responses in PsA study I were similar with and without concomitant methotrexate therapy. ACR responses were maintained in the open-label extension study for up to 136 weeks.

Radiographic changes were assessed in the psoriatic arthritis studies. Radiographs of hands, wrists, and feet were obtained at baseline and Week 24 during the double-blind period when patients were on adalimumab or placebo and at Week 48 when all patients were on open-label adalimumab. A modified Total Sharp Score (mTSS), which included distal interphalangeal joints (i.e. not identical to the TSS used for rheumatoid arthritis), was used.

Adalimumab treatment reduced the rate of progression of peripheral joint damage compared with placebo treatment as measured by change from baseline in mTSS (mean \pm SD) 0.8 ± 2.5 in the placebo group (at Week 24) compared with 0.0 ± 1.9 ; ($p < 0.001$) in the adalimumab group (at Week 48).

In subjects treated with adalimumab with no radiographic progression from baseline to Week 48 ($n=102$), 84 % continued to show no radiographic progression through 144 weeks of treatment. Adalimumab-treated patients demonstrated statistically significant improvement in physical function as assessed by HAQ and Short Form Health Survey (SF 36) compared to placebo at Week 24. Improved physical function continued during the open label extension up to Week 136.

Psoriasis

The safety and efficacy of adalimumab were studied in adult patients with chronic plaque psoriasis (≥ 10 % BSA involvement and Psoriasis Area and Severity Index (PASI) ≥ 12 or ≥ 10) who were candidates for systemic therapy or phototherapy in randomised, double-blind studies. 73 % of patients enrolled in Psoriasis Studies I and II had received prior systemic therapy or phototherapy. The safety and efficacy of adalimumab were also studied in adult patients with moderate to severe chronic plaque psoriasis with concomitant hand and/or foot psoriasis who were candidates for systemic therapy in a randomised double-blind study (Psoriasis Study III).

Psoriasis Study I (REVEAL) evaluated 1 212 patients within three treatment periods. In period A, patients received placebo or adalimumab at an initial dose of 80 mg followed by 40 mg every other week starting one week after the initial dose. After 16 weeks of therapy, patients who achieved at least a PASI 75 response (PASI score improvement of at least 75 % relative to baseline), entered period B and received open-label 40 mg adalimumab every other week. Patients who maintained \geq PASI 75 response at Week 33 and were originally randomised to active therapy in period A, were re-randomised in period C to receive 40 mg adalimumab every other week or placebo for an additional 19 weeks. Across all treatment groups, the mean baseline PASI score was 18.9 and the baseline Physician's Global Assessment (PGA) score ranged from "moderate" (53 % of subjects included) to "severe" (41 %) to "very severe" (6 %).

Psoriasis Study II (CHAMPION) compared the efficacy and safety of adalimumab *versus* methotrexate and placebo in 271 patients. Patients received placebo, an initial dose of MTX 7.5 mg and thereafter dose increases up to Week 12, with a maximum dose of 25 mg or an initial dose of 80 mg adalimumab followed by 40 mg every other week (starting one week after the initial dose) for 16 weeks. There are no data available comparing adalimumab and MTX beyond 16 weeks of therapy. Patients receiving MTX who achieved a \geq PASI 50 response at Week 8 and/or 12 did not receive further dose increases. Across all treatment groups, the mean baseline PASI score was 19.7 and the baseline PGA score ranged from "mild" (< 1 %) to "moderate" (48 %) to "severe" (46 %) to "very severe" (6 %).

Patients participating in all Phase 2 and Phase 3 psoriasis studies were eligible to enrol into an open-label extension study, where adalimumab was given for at least an additional 108 weeks.

In Psoriasis Studies I and II, a primary endpoint was the proportion of patients who achieved a PASI 75 response from baseline at Week 16 (see Tables 16 and 17).

Table 16. Ps study I (REVEAL) – efficacy results at 16 weeks

	placebo N = 398 n (%)	adalimumab 40 mg eow N = 814 n (%)
≥PASI 75 ^a	26 (6.5)	578 (70.9) ^b
PASI 100	3 (0.8)	163 (20.0) ^b
PGA: clear/minimal	17 (4.3)	506 (62.2) ^b

^a percent of patients achieving PASI75 response was calculated as centre-adjusted rate

^b p < 0.001, adalimumab vs. placebo

Table 17. Ps study II (CHAMPION) efficacy results at 16 weeks

	placebo N = 53 n (%)	MTX N = 110 n (%)	adalimumab 40 mg eow N=108 n (%)
≥PASI 75	10 (18.9)	39 (35.5)	86 (79.6) ^{a, b}
PASI 100	1 (1.9)	8 (7.3)	18 (16.7) ^{c, d}
PGA: clear/minimal	6 (11.3)	33 (30.0)	79 (73.1) ^{a, b}

^a p < 0.001 adalimumab vs. placebo

^b p < 0.001 adalimumab vs. methotrexate

^c p < 0.01 adalimumab vs. placebo

^d p < 0.05 adalimumab vs. methotrexate

In Psoriasis Study I, 28 % of patients who were PASI 75 responders and were re-randomised to placebo at Week 33 compared to 5 % continuing on adalimumab, p < 0.001, experienced “loss of adequate response” (PASI score after Week 33 and on or before Week 52 that resulted in a < PASI 50 response relative to baseline with a minimum of a 6-point increase in PASI score relative to Week 33). Of the patients who lost adequate response after re-randomisation to placebo who then enrolled into the open-label extension study, 38 % (25/66) and 55 % (36/66) regained PASI 75 response after 12 and 24 weeks of re-treatment, respectively.

A total of 233 PASI 75 responders at Week 16 and Week 33 received continuous adalimumab therapy for 52 weeks in Psoriasis Study I, and continued adalimumab in the open-label extension study. PASI 75 and PGA of clear or minimal response rates in these patients were 74.7 % and 59.0 %, respectively, after an additional 108 weeks of open-label therapy (total of 160 weeks). In an analysis in which all patients who dropped out of the study for adverse events or lack of efficacy, or who dose-escalated, were considered non-responders, PASI 75 and PGA of clear or minimal response rates in these patients were 69.6 % and 55.7 %, respectively, after an additional 108 weeks of open-label therapy (total of 160 weeks).

A total of 347 stable responders participated in a withdrawal and retreatment evaluation in an open-label extension study. During the withdrawal period, symptoms of psoriasis returned over time with a median time to relapse (decline to PGA “moderate” or worse) of approximately 5 months. None of these patients experienced rebound during the withdrawal period. A total of 76.5 % (218/285) of patients who entered the retreatment period had a response of PGA “clear” or “minimal” after 16 weeks of retreatment, irrespective of whether they relapsed during withdrawal (69.1 % [123/178] and 88.8 % [95/107] for patients who relapsed and who did not relapse during the withdrawal period, respectively). A similar safety profile was observed during retreatment as before withdrawal. Significant improvements at Week 16 from baseline compared to placebo (Studies I and II) and MTX (Study II) were demonstrated in the DLQI (Dermatology Life Quality Index). In Study I, improvements in the physical and mental component summary scores of the SF-36 were also

significant compared to placebo.

In an open-label extension study, for patients who dose escalated from 40 mg every other week to 40 mg weekly due to a PASI response below 50 %, 26.4 % (92/349) and 37.8 % (132/349) of patients achieved PASI 75 response at Week 12 and 24, respectively.

Psoriasis Study III (REACH) compared the efficacy and safety of adalimumab *versus* placebo in 72 patients with moderate to severe chronic plaque psoriasis and hand and/or foot psoriasis. Patients received an initial dose of 80 mg adalimumab followed by 40 mg every other week (starting one week after the initial dose) or placebo for 16 weeks. At Week 16, a statistically significantly greater proportion of patients who received adalimumab achieved PGA of 'clear' or 'almost clear' for the hands and/or feet compared to patients who received placebo (30.6% versus 4.3 %, respectively [P = 0.014]).

Psoriasis Study IV compared efficacy and safety of adalimumab versus placebo in 217 adult patients with moderate to severe nail psoriasis. Patients received an initial dose of 80 mg adalimumab followed by 40 mg every other week (starting one week after the initial dose) or placebo for 26 weeks followed by open-label adalimumab treatment for an additional 26 weeks. Nail psoriasis assessments included the Modified Nail Psoriasis Severity Index (mNAPSI), the Physician's Global Assessment of Fingernail Psoriasis (PGA-F) and the Nail Psoriasis Severity Index (NAPSI) (see Table 18). Adalimumab demonstrated a treatment benefit in nail psoriasis patients with different extents of skin involvement (BSA \geq 10 % (60 % of patients) and BSA < 10 % and \geq 5 % (40 % of patients)).

Table 18. Ps study IV efficacy results at 16, 26 and 52 weeks

endpoint	Week 16 placebo-controlled		Week 26 placebo-controlled		Week 52 open-label
	placebo N = 108	adalimumab 40 mg eow N = 109	placebo N = 108	adalimumab 40 mg eow N = 109	adalimumab 40 mg eow N = 80
\geq mNAPSI 75 (%)	2.9	26.0 ^a	3.4	46.6 ^a	65.0
PGA-F clear/minimal and \geq 2-grade improvement (%)	2.9	29.7 ^a	6.9	48.9 ^a	61.3
percent change in total fingernail NAPSI (%)	-7.8	-44.2 ^a	-11.5	-56.2 ^a	-72.2

^a p < 0.001, adalimumab vs. placebo

Adalimumab-treated patients showed statistically significant improvements at Week 26 compared with placebo in the DLQI.

Hidradenitis suppurativa

The safety and efficacy of adalimumab were assessed in randomised, double-blind, placebo-controlled studies and an open-label extension study in adult patients with moderate to severe hidradenitis suppurativa (HS) who were intolerant, had a contraindication or an inadequate response to at least a 3-month study of systemic antibiotic therapy. The patients in HS-I and HS-II had Hurley Stage II or III disease with at least 3 abscesses or inflammatory nodules.

Study HS-I (PIONEER I) evaluated 307 patients with 2 treatment periods. In period A, patients received placebo or adalimumab at an initial dose of 160 mg at Week 0, 80 mg at Week 2, and 40 mg every week starting at Week 4 to Week 11. Concomitant antibiotic use was not allowed during the study. After 12 weeks of therapy, patients who had received adalimumab in period A were re-randomised in period B to 1 of 3 treatment groups (adalimumab 40 mg every week, adalimumab

40 mg every other week, or placebo from Week 12 to Week 35). Patients who had been randomised to placebo in period A were assigned to receive adalimumab 40 mg every week in period B.

Study HS-II (PIONEER II) evaluated 326 patients with 2 treatment periods. In period A, patients received placebo or adalimumab at an initial dose of 160 mg at Week 0 and 80 mg at Week 2 and 40 mg every week starting at Week 4 to Week 11. 19.3 % of patients had continued baseline oral antibiotic therapy during the study. After 12 weeks of therapy, patients who had received adalimumab in period A were re-randomised in period B to 1 of 3 treatment groups (adalimumab 40 mg every week, adalimumab 40 mg every other week, or placebo from Week 12 to Week 35). Patients who had been randomised to placebo in period A were assigned to receive placebo in period B.

Patients participating in Studies HS-I and HS-II were eligible to enrol into an open-label extension study in which adalimumab 40 mg was administered every week. Mean exposure in all adalimumab population was 762 days. Throughout all 3 studies patients used topical antiseptic wash daily.

Clinical response

Reduction of inflammatory lesions and prevention of worsening of abscesses and draining fistulas was assessed using Hidradenitis Suppurativa Clinical Response (HiSCR; at least a 50 % reduction in total abscess and inflammatory nodule count with no increase in abscess count and no increase in draining fistula count relative to Baseline). Reduction in HS-related skin pain was assessed using a Numeric Rating Scale in patients who entered the study with an initial baseline score of 3 or greater on a 11 point scale.

At Week 12, a significantly higher proportion of patients treated with adalimumab versus placebo achieved HiSCR. At Week 12, a significantly higher proportion of patients in Study HS-II experienced a clinically relevant decrease in HS-related skin pain (see Table 19). Patients treated with adalimumab had significantly reduced risk of disease flare during the initial 12 weeks of treatment.

Table 19. Efficacy results at 12 weeks, HS studies I and II

	HS study I		HS study II	
	placebo	adalimumab 40 mg weekly	placebo	adalimumab 40 mg weekly
hidradenitis suppurativa clinical response (HiSCR) ^a	N = 154 40 (26.0 %)	N = 153 64 (41.8 %)*	N = 163 45 (27.6 %)	N = 163 96 (58.9 %) ^{***}
≥30% reduction in skin pain ^b	N = 109 27 (24.8 %)	N = 122 34 (27.9 %)	N = 111 23 (20.7 %)	N = 105 48 (45.7 %) ^{***}

* $p < 0.05$,

^{***} $p < 0.001$, adalimumab versus placebo

^a among all randomised patients.

^b among patients with baseline HS-related skin pain assessment ≥ 3 , based on Numeric Rating Scale 0–10; 0 = no skin pain, 10 = skin pain as bad as you can imagine.

Treatment with adalimumab 40 mg every week significantly reduced the risk of worsening of abscesses and draining fistulas. Approximately twice the proportion of patients in the placebo group in the first 12 weeks of Studies HS-I and HS-II, compared with those in the adalimumab group experienced worsening of abscesses (23.0 % vs 11.4 %, respectively) and draining fistulas (30.0 %

vs 13.9 %, respectively).

Greater improvements at Week 12 from baseline compared to placebo were demonstrated in skin-specific health-related quality of life, as measured by the Dermatology Life Quality Index (DLQI; Studies HS-I and HS-II), patient global satisfaction with medicinal product treatment as measured by the Treatment Satisfaction Questionnaire – medication (TSQM; Studies HS-I and HS-II), and physical health as measured by the physical component summary score of the SF-36 (Study HS-I).

In patients with at least a partial response to adalimumab 40 mg weekly at Week 12, the HiSCR rate at Week 36 was higher in patients who continued weekly adalimumab than in patients in whom dosing frequency was reduced to every other week, or in whom treatment was withdrawn (see Table 20).

Table 20. Proportion of patients^a achieving HiSCR^b at Weeks 24 and 36 after treatment reassignment from weekly adalimumab at Week 12

	placebo (treatment withdrawal) N = 73	adalimumab 40 mg every other week N = 70	adalimumab 40 mg weekly N = 70
Week 24	24 (32.9 %)	36 (51.4 %)	40 (57.1 %)
Week 36	22 (30.1 %)	28 (40.0 %)	39 (55.7 %)

^a patients with at least a partial response to adalimumab 40 mg weekly after 12 weeks of treatment.

^b patients meeting protocol-specified criteria for loss of response or no improvement were required to discontinue from the studies and were counted as non-responders.

Among patients who were at least partial responders at Week 12, and who received continuous weekly adalimumab therapy, the HiSCR rate at Week 48 was 68.3 % and at Week 96 was 65.1 %. Longer term treatment with adalimumab 40 mg weekly for 96 weeks identified no new safety findings.

Among patients whose adalimumab treatment was withdrawn at Week 12 in Studies HS-I and HS-II, the HiSCR rate 12 weeks after re-introduction of adalimumab 40 mg weekly returned to levels similar to that observed before withdrawal (56.0 %).

Crohn's disease

The safety and efficacy of adalimumab were assessed in over 1 500 patients with moderately to severely active Crohn's disease (Crohn's Disease Activity Index (CDAI) ≥ 220 and ≤ 450) in randomised, double-blind, placebo-controlled studies. Concomitant stable doses of aminosaliculates, corticosteroids, and/or immunomodulatory agents were permitted and 80 % of patients continued to receive at least one of these medicinal products.

Induction of clinical remission (defined as CDAI < 150) was evaluated in two studies, CD Study I (CLASSIC I) and CD Study II (GAIN). In CD Study I, 299 TNF-antagonist naïve patients were randomised to one of four treatment groups; placebo at Weeks 0 and 2, 160 mg adalimumab at Week 0 and 80 mg at Week 2, 80 mg at Week 0 and 40 mg at Week 2, and 40 mg at Week 0 and 20 mg at Week 2. In CD Study II, 325 patients who had lost response or were intolerant to infliximab were randomised to receive either 160 mg adalimumab at Week 0 and 80 mg at Week 2 or placebo at Weeks 0 and 2. The primary non-responders were excluded from the studies and therefore these patients were not further evaluated.

Maintenance of clinical remission was evaluated in CD study III (CHARM). In CD study III, 854 patients received open-label 80 mg at Week 0 and 40 mg at Week 2. At Week 4 patients were randomised to 40 mg every other week, 40 mg every week, or placebo with a total study duration of 56 weeks. Patients in clinical response (decrease in CDAI \geq 70) at Week 4 were stratified and analysed separately from those not in clinical response at Week 4. Corticosteroid taper was permitted after Week 8.

CD study I and CD study II induction of remission and response rates are presented in Table 21.

**Table 21. Induction of clinical remission and response
(percent of patients)**

	CD study I: infliximab-naïve patients			CD study II: infliximab-experienced patients	
	placebo N = 74	adalimumab 80/40 mg N = 75	adalimumab 160/80 mg N = 76	placebo N=166	adalimumab 160/80 mg N = 159
Week 4					
clinical remission	12 %	24 %	36 %*	7 %	21 %*
clinical response (CR-100)	24 %	37 %	49 %**	25 %	38 %**

All p-values are pairwise comparisons of proportions for adalimumab *versus* placebo

* p < 0.001

** p < 0.01

Similar remission rates were observed for the 160/80 mg and 80/40 mg induction regimens by Week 8 and adverse events were more frequently noted in the 160/80 mg group.

In CD study III, at Week 4, 58 % (499/854) of patients were in clinical response and were assessed in the primary analysis. Of those in clinical response at Week 4, 48 % had been previously exposed to other TNF-antagonists. Maintenance of remission and response rates are presented in Table 22. Clinical remission results remained relatively constant irrespective of previous TNF-antagonist exposure. Disease-related hospitalisations and surgeries were statistically significantly reduced with adalimumab compared with placebo at Week 56.

**Table 22. Maintenance of clinical remission and response
(percent of patients)**

	placebo	40 mg adalimumab every other week	40 mg adalimumab every week
Week 26	N = 170	N = 172	N = 157
clinical remission	17 %	40 %*	47 %*
clinical response (CR-100)	27 %	52 %*	52 %*
patients in steroid-free remission for ≥ 90 days ^a	3 % (2/66)	19 % (11/58)**	15 % (11/74)**
Week 56	N = 170	N = 172	N = 157
clinical remission	12 %	36 %*	41 %*
clinical response (CR-100)	17 %	41 %*	48 %*
patients in steroid-free remission for ≥ 90 days ^a	5 % (3/66)	29 % (17/58)*	20 % (15/74)**

* $p < 0.001$ for adalimumab *versus* placebo pairwise comparisons of proportions

** $p < 0.02$ for adalimumab *versus* placebo pairwise comparisons of proportions

^a of those receiving corticosteroids at baseline

Among patients who were not in response at Week 4, 43 % of adalimumab maintenance patients responded by Week 12 compared to 30 % of placebo maintenance patients. These results suggest that some patients who have not responded by Week 4 benefit from continued maintenance therapy through Week 12. Therapy continued beyond 12 weeks did not result in significantly more responses (see section 4.2).

117/276 patients from CD study I and 272/777 patients from CD studies II and III were followed through at least 3 years of open-label adalimumab therapy. 88 and 189 patients, respectively, continued to be in clinical remission. Clinical response (CR-100) was maintained in 102 and 233 patients, respectively.

Quality of life

In CD study I and CD study II, statistically significant improvement in the disease-specific inflammatory bowel disease questionnaire (IBDQ) total score was achieved at Week 4 in patients randomised to adalimumab 80/40 mg and 160/80 mg compared to placebo and was seen at Weeks 26 and 56 in CD study III as well among the adalimumab treatment groups compared to the placebo group.

Ulcerative colitis

The safety and efficacy of multiple doses of adalimumab were assessed in adult patients with moderately to severely active ulcerative colitis (Mayo score 6 to 12 with endoscopy subscore of 2 to 3) in randomised, double-blind, placebo-controlled studies.

In study UC-I, 390 TNF-antagonist naïve patients were randomised to receive either placebo at Weeks 0 and 2, 160 mg adalimumab at Week 0 followed by 80 mg at Week 2, or 80 mg adalimumab at Week 0 followed by 40 mg at Week 2. After Week 2, patients in both adalimumab arms received 40 mg eow. Clinical remission (defined as Mayo score ≤ 2 with no subscore > 1) was assessed at Week 8.

In study UC-II, 248 patients received 160 mg of adalimumab at Week 0, 80 mg at Week 2 and 40 mg eow thereafter, and 246 patients received placebo. Clinical results were assessed for induction of

remission at Week 8 and for maintenance of remission at Week 52.

Patients induced with 160/80 mg adalimumab achieved clinical remission versus placebo at Week 8 in statistically significantly greater percentages in study UC-I (18 % vs. 9 % respectively, $p = 0.031$) and study UC-II (17 % vs. 9 % respectively, $p = 0.019$). In study UC-II, among those treated with adalimumab who were in remission at Week 8, 21/41 (51 %) were in remission at Week 52.

Results from the overall UC-II study population are shown in Table 23.

Table 23. Response, remission and mucosal healing in study UC-II (percent of patients)

	placebo	adalimumab 40 mg eow
Week 52	N = 246	N = 248
clinical response	18 %	30 %*
clinical remission	9 %	17 %*
mucosal healing	15 %	25 %*
steroid-free remission for ≥ 90 days ^a	6 %	13 %*
	(N = 140)	(N = 150)
Week 8 and 52		
sustained response	12 %	24 %**
sustained remission	4 %	8 %*
sustained mucosal healing	11 %	19 %*

clinical remission is Mayo score ≤ 2 with no subscore > 1 ;

clinical response is decrease from baseline in Mayo score ≥ 3 points and ≥ 30 % plus a decrease in the rectal bleeding subscore [RBS] ≥ 1 or an absolute RBS of 0 or 1;

* $p < 0.05$ for adalimumab vs. placebo pairwise comparison of proportions

** $p < 0.001$ for adalimumab vs. placebo pairwise comparison of proportions

^a of those receiving corticosteroids at baseline

Of those patients who had a response at Week 8, 47 % were in response, 29 % were in remission, 41 % had mucosal healing, and 20 % were in steroid-free remission for ≥ 90 days at Week 52.

Approximately 40 % of patients in study UC-II had failed prior anti-TNF treatment with infliximab. The efficacy of adalimumab in those patients was reduced compared to that in anti-TNF naïve patients. Among patients who had failed prior anti-TNF treatment, Week 52 remission was achieved by 3 % on placebo and 10 % on adalimumab.

Patients from studies UC-I and UC-II had the option to roll over into an open-label long-term extension study (UC III). Following 3 years of adalimumab therapy, 75 % (301/402) continued to be in clinical remission per partial Mayo score.

Hospitalisation rates

During 52 weeks of studies UC-I and UC-II, lower rates of all-cause hospitalisations and UC-related hospitalisations were observed for the adalimumab-treated arm compared to the placebo arm. The number of all cause hospitalisations in the adalimumab treatment group was 0.18 per patient year vs. 0.26 per patient year in the placebo group and the corresponding figures for UC-related hospitalisations were 0.12 per patient year vs. 0.22 per patient year.

Quality of life

In study UC-II, treatment with adalimumab resulted in improvements in the Inflammatory Bowel Disease Questionnaire (IBDQ) score.

Uveitis

The safety and efficacy of adalimumab were assessed in adult patients with non-infectious intermediate, posterior, and panuveitis, excluding patients with isolated anterior uveitis, in two randomised, double-masked, placebo-controlled studies (UV I and II). Patients received placebo or adalimumab at an initial dose of 80 mg followed by 40 mg every other week starting one week after the initial dose. Concomitant stable doses of one non-biologic immunosuppressant were permitted.

Study UV I evaluated 217 patients with active uveitis despite treatment with corticosteroids (oral prednisone at a dose of 10 to 60 mg/day). All patients received a 2-week standardised dose of prednisone 60 mg/day at study entry followed by a mandatory taper schedule, with complete corticosteroid discontinuation by Week 15.

Study UV II evaluated 226 patients with inactive uveitis requiring chronic corticosteroid treatment (oral prednisone 10 to 35 mg/day) at baseline to control their disease. Patients subsequently underwent a mandatory taper schedule, with complete corticosteroid discontinuation by Week 19.

The primary efficacy endpoint in both studies was ‘time to treatment failure’. Treatment failure was defined by a multi-component outcome based on inflammatory chorioretinal and/or inflammatory retinal vascular lesions, anterior chamber (AC) cell grade, vitreous haze (VH) grade and best corrected visual acuity (BCVA).

Patients who completed studies UV I and UV II were eligible to enroll in an uncontrolled long-term extension study with an originally planned duration of 78 weeks. Patients were allowed to continue on study medicinal product beyond Week 78 until they had access to adalimumab.

Clinical response

Results from both studies demonstrated statistically significant reduction of the risk of treatment failure in patients treated with adalimumab versus patients receiving placebo (see Table 24). Both studies demonstrated an early and sustained effect of adalimumab on the treatment failure rate versus placebo (see Figure 2).

Table 24. Time to treatment failure in studies UV I and UV II

analysis treatment	N	failure N (%)	median time to failure (months)	HR ^a	CI 95 % for HR ^a	<i>p</i> Value ^b
time to treatment failure at or after Week 6 in study UV I						
primary analysis (ITT)						
placebo	107	84 (78.5)	3.0	--	--	--
adalimumab	110	60 (54.5)	5.6	0.50	0.36, 0.70	< 0.001
time to treatment failure at or after Week 2 in study UV II						
primary analysis (ITT)						
placebo	111	61 (55.0)	8.3	--	--	--
adalimumab	115	45 (39.1)	NE ^c	0.57	0.39, 0.84	0.004

Note: treatment failure at or after Week 6 (study UV I), or at or after Week 2 (study UV II), was counted as event. Drop outs due to reasons other than treatment failure were censored at the time of dropping out.

^a HR of adalimumab vs placebo from proportional hazards regression with treatment as factor.

^b 2-sided *p* value from log rank test.

^c NE = not estimable. Fewer than half of at-risk subjects had an event.

Figure 2: Kaplan-Meier curves summarizing time to treatment failure on or after Week 6 (study UV I) or Week 2 (study UV II)

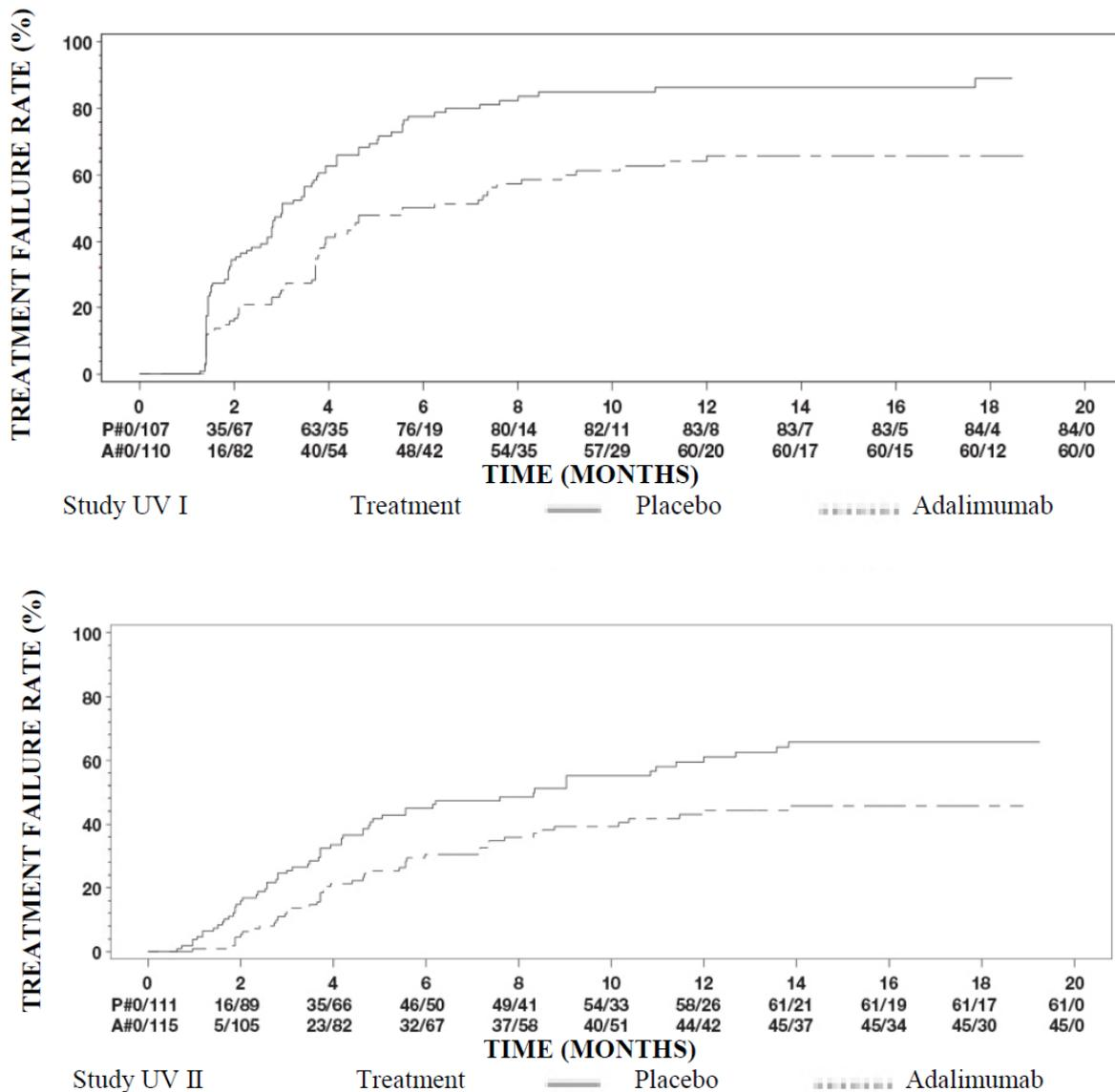

Note: P# = Placebo (Number of Events/Number at Risk); A# = Adalimumab (Number of Events/Number at Risk).

In Study UV I statistically significant differences in favour of adalimumab versus placebo were observed for each component of treatment failure. In Study UV II, statistically significant differences were observed for visual acuity only, but the other components were numerically in favour of adalimumab.

Of the 424 subjects included in the uncontrolled long-term extension of studies UV I and UV II, 60 subjects were regarded ineligible (e.g. due to deviations or due to complications secondary to diabetic retinopathy, due to cataract surgery or vitrectomy) and were excluded from the primary analysis of efficacy. Of the 364 remaining patients, 269 evaluable patients (74 %) reached 78 weeks of open-label adalimumab treatment. Based on the observed data approach, 216 (80.3 %) were in quiescence (no active inflammatory lesions, AC cell grade $\leq 0.5+$, VH grade $\leq 0.5+$) with a concomitant steroid dose ≤ 7.5 mg per day, and 178 (66.2 %) were in steroid-free quiescence. BCVA was either improved or maintained (< 5 letters deterioration) in 88.6 % of the eyes at Week 78. Data beyond Week 78 were generally consistent with these results but the number of enrolled subjects declined after this time. Overall, among the patients who discontinued the study, 18 % discontinued due

to adverse events, and 8 % due to insufficient response to adalimumab treatment.

Quality of Life

Patient reported outcomes regarding vision-related functioning were measured in both clinical studies, using the NEI VFQ-25. Adalimumab was numerically favoured for the majority of subscores with statistically significant mean differences for general vision, ocular pain, near vision, mental health, and total score in study UV I, and for general vision and mental health in study UV II. Vision related effects were not numerically in favour of adalimumab for colour vision in study UV I and for colour vision, peripheral vision and near vision in study UV II.

Immunogenicity

Anti-adalimumab antibodies may develop during adalimumab treatment. Formation of anti-adalimumab antibodies is associated with increased clearance and reduced efficacy of adalimumab. There is no apparent correlation between the presence of anti-adalimumab antibodies and the occurrence of adverse events.

Paediatric population

Juvenile idiopathic arthritis (JIA)

Polyarticular juvenile idiopathic arthritis (pJIA)

The safety and efficacy of adalimumab was assessed in two studies (pJIA I and II) in children with active polyarticular or polyarticular course juvenile idiopathic arthritis, who had a variety of JIA onset types (most frequently rheumatoid-factor negative or positive polyarthritis and extended oligoarthritis).

pJIA I

The safety and efficacy of adalimumab were assessed in a multicentre, randomised, double-blind, parallel-group study in 171 children (4–17 years old) with polyarticular JIA. In the open-label lead in phase (OL LI) patients were stratified into two groups, MTX (methotrexate)-treated or non-MTX-treated. Patients who were in the non-MTX stratum were either naïve to or had been withdrawn from MTX at least two weeks prior to study drug administration. Patients remained on stable doses of non-steroidal anti-inflammatory drugs (NSAIDs) and or prednisone (≤ 0.2 mg/kg/day or 10 mg/day maximum). In the OL LI phase all patients received 24 mg/m² up to a maximum of 40 mg adalimumab every other week for 16 weeks. The distribution of patients by age and minimum, median and maximum dose received during the OL LI phase is presented in Table 25.

Table 25. Distribution of patients by age and adalimumab dose received during the OL LI phase

age group	number of patients at baseline n (%)	Minimum, median and maximum dose
4 to 7 years	31 (18.1)	10, 20 and 25 mg
8 to 12 years	71 (41.5)	20, 25 and 40 mg
13 to 17 years	69 (40.4)	25, 40 and 40 mg

Patients demonstrating a paediatric ACR 30 response at Week 16 were eligible to be randomised into the double blind (DB) phase and received either adalimumab 24 mg/m² up to a maximum of 40 mg, or placebo every other week for an additional 32 weeks or until disease flare. Disease flare criteria were defined as a worsening of ≥ 30 % from baseline in ≥ 3 of 6 paediatric ACR core criteria, ≥ 2 active joints, and improvement of > 30 % in no more than 1 of the 6 criteria. After 32 weeks or at disease flare, patients were eligible to enrol into the open label extension phase.

Table 26. Ped ACR 30 responses in the JIA study

stratum	MTX		without MTX	
phase				
OL-LI 16 weeks				
ped ACR 30 response (n/N)	94.1 % (80/85)		74.4% (64/86)	
efficacy outcomes				
double blind 32 weeks	adalimumab/M TX (N =38)	placebo/MTX (N = 37)	adalimumab (N = 30)	placebo (N = 28)
disease flares at the end of 32 weeks ^a (n/N)	36.8 % (14/38)	64.9 % (24/37) ^b	43.3 % (13/30)	71.4 % (20/28) ^c
median time to disease flare	>32 weeks	20 weeks	>32 weeks	14 weeks

^a ped ACR 30/50/70 responses Week 48 significantly greater than those of placebo-treated patients

^b p = 0.015

^c p = 0.031

Amongst those who responded at Week 16 (n = 144), the paediatric ACR 30/50/70/90 responses were maintained for up to six years in the OLE phase in patients who received adalimumab throughout the study. Over all 19 subjects, of which 11 of the baseline age group 4 to 12 and 8 of the baseline age group 13 to 17 years were treated 6 years or longer.

Overall responses were generally better and, fewer patients developed antibodies when treated with the combination of adalimumab and MTX compared to adalimumab alone. Taking these results into consideration, Hyrimoz is recommended for use in combination with MTX and for use as monotherapy in patients for whom MTX use is not appropriate (see section 4.2).

pJIA II

The safety and efficacy of adalimumab was assessed in an open-label, multicentre study in 32 children (2–< 4 years old or aged 4 and above weighing < 15 kg) with moderately to severely active polyarticular JIA. The patients received 24 mg/m² body surface area (BSA) of adalimumab up to a maximum of 20 mg every other week as a single dose via SC injection for at least 24 weeks. During the study, most subjects used concomitant MTX, with fewer reporting use of corticosteroids or NSAIDs.

At Week 12 and Week 24, PedACR30 response was 93.5 % and 90.0 %, respectively, using the observed data approach. The proportions of subjects with PedACR50/70/90 at Week 12 and Week 24 were 90.3 %/61.3 %/38.7 % and 83.3 %/73.3 %/36.7 %, respectively. Amongst those who responded (paediatric ACR 30) at Week 24 (n = 27 out of 30 patients), the paediatric ACR 30 responses were maintained for up to 60 weeks in the OLE phase in patients who received adalimumab throughout this time period. Overall, 20 subjects were treated for 60 weeks or longer.

Enthesitis-related arthritis

The safety and efficacy of adalimumab were assessed in a multicentre, randomised, double-blind study in 46 paediatric patients (6 to 17 years old) with moderate enthesitis-related arthritis. Patients were randomised to receive either 24 mg/m² body surface area (BSA) of adalimumab up to a maximum of 40 mg, or placebo every other week for 12 weeks. The double-blind period is followed by an open-label

(OL) period during which patients received 24 mg/m² BSA of adalimumab up to a maximum of 40 mg every other week subcutaneously for up to an additional 192 weeks. The primary endpoint was the percent change from Baseline to Week 12 in the number of active joints with arthritis (swelling not due to deformity or joints with loss of motion plus pain and/or tenderness), which was achieved with mean percent decrease of -62.6 % (median percent change -88.9 %) in patients in the adalimumab group compared to -11.6 % (median percent change -50.0 %) in patients in the placebo group. Improvement in number of active joints with arthritis was maintained during the OL period through Week 156 for the 26 of 31 (84 %) patients in the adalimumab group who remained in the study. Although not statistically significant, the majority of patients demonstrated clinical improvement in secondary endpoints such as number of sites of enthesitis, tender joint count (TJC), swollen joint count (SJC), paediatric ACR 50 response, and paediatric ACR 70 response.

Paediatric plaque psoriasis

The efficacy of adalimumab was assessed in a randomised, double-blind, controlled study of 114 paediatric patients from 4 years of age with severe chronic plaque psoriasis (as defined by a Physician's Global Assessment (PGA) ≥ 4 or > 20 % BSA involvement or > 10 % BSA involvement with very thick lesions or Psoriasis Area and Severity Index (PASI) ≥ 20 or ≥ 10 with clinically relevant facial, genital, or hand/foot involvement) who were inadequately controlled with topical therapy and heliotherapy or phototherapy.

Patients received adalimumab 0.8 mg/kg eow (up to 40 mg), 0.4 mg/kg eow (up to 20 mg), or methotrexate 0.1–0.4 mg/kg weekly (up to 25 mg). At Week 16, more patients randomised to adalimumab 0.8 mg/kg had positive efficacy responses (e.g., PASI 75) than those randomised to 0.4 mg/kg eow or MTX.

Table 27. Paediatric plaque psoriasis efficacy results at 16 weeks

	MTX ^a N = 37	adalimumab 0.8 mg/kg eow N=38
PASI 75 ^b	12 (32.4 %)	22 (57.9 %)
PGA: clear/minimal ^c	15 (40.5 %)	23 (60.5 %)

^a MTX = methotrexate

^b p = 0.027, adalimumab 0.8 mg/kg versus MTX

^c p = 0.083, adalimumab 0.8 mg/kg versus MTX

Patients who achieved PASI 75 and PGA clear or minimal were withdrawn from treatment for up to 36 weeks and monitored for loss of disease control (i.e. a worsening of PGA by at least 2 grades). Patients were then re-treated with adalimumab 0.8 mg/kg eow for an additional 16 weeks and response rates observed during retreatment were similar to the previous double-blind period: PASI 75 response of 78.9 % (15 of 19 subjects) and PGA clear or minimal of 52.6 % (10 of 19 subjects).

In the open label period of the study, PASI 75 and PGA clear or minimal responses were maintained for up to an additional 52 weeks with no new safety findings.

Adolescent hidradenitis suppurativa

There are no clinical studies with adalimumab in adolescent patients with HS. Efficacy of adalimumab for the treatment of adolescent patients with HS is predicted based on the demonstrated efficacy and exposure-response relationship in adult HS patients and the likelihood that the disease course, pathophysiology, and drug effects are substantially similar to that of adults at the same exposure levels. Safety of the recommended adalimumab dose in the adolescent HS population is based on

cross-indication safety profile of adalimumab in both adults and paediatric patients at similar or more frequent doses (see section 5.2).

Paediatric Crohn's disease

Adalimumab was assessed in a multicentre, randomised, double-blind clinical study designed to evaluate the efficacy and safety of induction and maintenance treatment with doses dependent on body weight (< 40 kg or ≥ 40 kg) in 192 paediatric subjects between the ages of 6 and 17 (inclusive) years, with moderate to severe Crohn's disease (CD) defined as Paediatric Crohn's Disease Activity Index (PCDAI) score > 30. Subjects had to have failed conventional therapy (including a corticosteroid and/or an immunomodulator) for CD. Subjects may also have previously lost response or been intolerant to infliximab.

All subjects received open-label induction therapy at a dose based on their Baseline body weight: 160 mg at Week 0 and 80 mg at Week 2 for subjects ≥ 40 kg, and 80 mg and 40 mg, respectively, for subjects < 40 kg.

At Week 4, subjects were randomised 1:1 based on their body weight at the time to either the Low Dose or Standard Dose maintenance regimens as shown in Table 28.

Table 28. Maintenance regimen

patient weight	low dose	standard dose
< 40 kg	10 mg eow	20 mg eow
≥ 40 kg	20 mg eow	40 mg eow

Efficacy results

The primary endpoint of the study was clinical remission at Week 26, defined as PCDAI score ≤ 10.

Clinical remission and clinical response (defined as reduction in PCDAI score of at least 15 points from Baseline) rates are presented in Table 29. Rates of discontinuation of corticosteroids or immunomodulators are presented in Table 30.

**Table 29. Paediatric CD study
PCDAI clinical remission and response**

	standard dose 40/20 mg eow N = 93	low dose 20/10 mg eow N = 95	p value*
Week 26			
clinical remission	38.7 %	28.4 %	0.075
clinical response	59.1 %	48.4 %	0.073
Week 52			
clinical remission	33.3 %	23.2 %	0.100
clinical response	41.9 %	28.4 %	0.038

* p-value for standard dose *versus* low dose comparison.

**Table 30. Paediatric CD study
discontinuation of corticosteroids or immunomodulators and fistula remission**

	standard dose 40/20 mg eow	low dose 20/10 mg eow	p value¹
discontinued corticosteroids	N = 33	N = 38	
Week 26	84.8 %	65.8 %	0.066
Week 52	69.7 %	60.5 %	0.420
discontinuation of Immunomodulators²	N = 60	N = 57	
Week 52	30.0 %	29.8 %	0.983
fistula remission³	N = 15	N = 21	
Week 26	46.7 %	38.1 %	0.608
Week 52	40.0 %	23.8 %	0.303

¹ p value for standard dose *versus* low dose comparison.

² immunosuppressant therapy could only be discontinued at or after Week 26 at the investigator's discretion if the subject met the clinical response criterion

³ defined as a closure of all fistulas that were draining at Baseline for at least 2 consecutive post-Baseline visits

Statistically significant increases (improvement) from Baseline to Week 26 and 52 in Body Mass Index and height velocity were observed for both treatment groups.

Statistically and clinically significant improvements from Baseline were also observed in both treatment groups for quality of life parameters (including IMPACT III).

One hundred patients (n = 100) from the Paediatric CD Study continued in an open-label long-term extension study. After 5 years of adalimumab therapy, 74.0 % (37/50) of the 50 patients remaining in the study continued to be in clinical remission, and 92.0 % (46/50) of patients continued to be in clinical response per PCDAI.

Paediatric ulcerative colitis

The safety and efficacy of adalimumab was assessed in a multicenter, randomized, double-blind, study in 93 paediatric patients from 5 to 17 years of age with moderate to severe ulcerative colitis (Mayo score 6 to 12 with endoscopy subscore of 2 to 3 points, confirmed by centrally read endoscopy) who had an inadequate response or intolerance to conventional therapy. Approximately 16 % of patients in the study had failed prior anti-TNF treatment. Patients who received corticosteroids at enrollment were allowed to taper their corticosteroid therapy after Week 4.

In the induction period of the study, 77 patients were randomized 3:2 to receive double-blind treatment with adalimumab at an induction dose of 2.4 mg/kg (maximum of 160 mg) at Week 0 and Week 1, and 1.2 mg/kg (maximum of 80 mg) at Week 2; or an induction dose of 2.4 mg/kg (maximum of 160 mg) at Week 0, placebo at Week 1, and 1.2 mg/kg (maximum of 80 mg) at Week 2. Both groups received 0.6 mg/kg (maximum of 40 mg) at Week 4 and Week 6. Following an amendment to the study design, the remaining 16 patients who enrolled in the induction period received open-label treatment with adalimumab at the induction dose of 2.4 mg/kg (maximum of 160 mg) at Week 0 and Week 1, and 1.2 mg/kg (maximum of 80 mg) at Week 2.

At Week 8, 62 patients who demonstrated clinical response per Partial Mayo Score (PMS; defined as a decrease in PMS ≥ 2 points and ≥ 30 % from Baseline) were randomized equally to receive double-

blind maintenance treatment with adalimumab at a dose of 0.6 mg/kg (maximum of 40 mg) every week (ew), or a maintenance dose of 0.6 mg/kg (maximum of 40 mg) every other week (eow). Prior to an amendment to the study design, 12 additional patients who demonstrated clinical response per PMS were randomized to receive placebo but were not included in the confirmatory analysis of efficacy.

Disease flare was defined as an increase in PMS of at least 3 points (for patients with PMS of 0 to 2 at Week 8), at least 2 points (for patients with PMS of 3 to 4 at Week 8), or at least 1 point (for patients with PMS of 5 to 6 at Week 8).

Patients who met criteria for disease flare at or after Week 12 were randomized to receive a re-induction dose of 2.4 mg/kg (maximum of 160 mg) or a dose of 0.6 mg/kg (maximum of 40 mg) and continued to receive their respective maintenance dose regimen afterwards.

Efficacy results

The co-primary endpoints of the study were clinical remission per PMS (defined as PMS \leq 2 and no individual subscore $>$ 1) at Week 8, and clinical remission per FMS (Full Mayo Score) (defined as a Mayo Score \leq 2 and no individual subscore $>$ 1) at Week 52 in patients who achieved clinical response per PMS at Week 8.

Clinical remission rates per PMS at Week 8 for patients in each of the adalimumab doubleblind induction groups are presented in Table 31.

Table 31. Clinical remission per PMS at 8 weeks

	Adalimumab^a Maximum of 160 mg at Week 0/Placebo at Week 1 N=30	Adalimumab^{b, c} Maximum of 160 mg at Week 0 and Week 1 N=47
Clinical remission	13/30 (43.3%)	28/47 (59.6%)
^a Adalimumab 2.4 mg/kg (maximum of 160 mg) at Week 0, placebo at Week 1, and 1.2 mg/kg (maximum of 80 mg) at Week 2 ^b Adalimumab 2.4 mg/kg (maximum of 160 mg) at Week 0 and Week 1, and 1.2 mg/kg (maximum of 80 mg) at Week 2 ^c Not including open-label Induction dose of adalimumab 2.4 mg/kg (maximum of 160 mg) at Week 0 and Week 1, and 1.2 mg/kg (maximum of 80 mg) at Week 2 Note 1: Both induction groups received 0.6 mg/kg (maximum of 40 mg) at Week 4 and Week 6 Note 2: Patients with missing values at Week 8 were considered as not having met the endpoint		

At Week 52, clinical remission per FMS in Week 8 responders, clinical response per FMS (defined as a decrease in Mayo Score \geq 3 points and \geq 30 % from Baseline) in Week 8 responders, mucosal healing per FMS (defined as an Mayo endoscopy subscore \leq 1) in Week 8 responders, clinical remission per FMS in Week 8 remitters, and the proportion of subjects in corticosteroid-free remission per FMS in Week 8 responders were assessed in patients who received adalimumab at the double-blind maximum 40 mg eow (0.6 mg/kg) and maximum 40 mg ew (0.6 mg/kg) maintenance doses (32).

Table 32. Efficacy results at 52 weeks

	Adalimumab^a Maximum of 40 mg eow N=31	Adalimumab^b Maximum of 40 mg ew N=31
Clinical remission in Week 8 PMS responders	9/31 (29.0%)	14/31 (45.2%)
Clinical response in Week 8 PMS responders	19/31 (61.3%)	21/31 (67.7%)
Mucosal healing in Week 8 PMS responders	12/31 (38.7%)	16/31 (51.6%)
Clinical remission in Week 8 PMS remitters	9/21 (42.9%)	10/22 (45.5%)
Corticosteroid-free remission in Week 8 PMS responders ^c	4/13 (30.8%)	5/16 (31.3%)
^a Adalimumab 0.6 mg/kg (maximum of 40 mg) every other week ^b Adalimumab 0.6 mg/kg (maximum of 40 mg) every week ^c In patients receiving concomitant corticosteroids at baseline Note: Patients with missing values at Week 52 or who were randomized to receive re-induction or maintenance treatment were considered non-responders for Week 52 endpoints		

Additional exploratory efficacy endpoints included clinical response per the Paediatric Ulcerative Colitis Activity Index (PUCAI) (defined as a decrease in PUCAI \geq 20 points from Baseline) and clinical remission per PUCAI (defined as PUCAI < 10) at Week 8 and Week 52 (Table 33).

Table 33. Exploratory endpoints results per PUCAI

	Week 8	
	Adalimumab^a Maximum of 160 mg at Week 0/Placebo at Week 1 N=30	Adalimumab^{b,c} Maximum of 160 mg at Week 0 and Week 1 N=47
Clinical remission per PUCAI	10/30 (33.3%)	22/47 (46.8%)
Clinical response per PUCAI	15/30 (50.0%)	32/47 (68.1%)
	Week 52	
	Adalimumab^d Maximum of 40 mg eow N=31	Adalimumab^e Maximum of 40 mg ew N=31
Clinical remission per PUCAI in Week 8 PMS responders	14/31 (45.2%)	18/31 (58.1%)
Clinical response per PUCAI in Week 8 PMS responders	18/31 (58.1%)	16/31 (51.6%)

- a Adalimumab 2.4 mg/kg (maximum of 160 mg) at Week 0, placebo at Week 1, and 1.2 mg/kg (maximum of 80 mg) at Week 2
- b Adalimumab 2.4 mg/kg (maximum of 160 mg) at Week 0 and Week 1, and 1.2 mg/kg (maximum of 80 mg) at Week 2
- c Not including open-label Induction dose of adalimumab 2.4 mg/kg (maximum of 160 mg) at Week 0 and Week 1, and 1.2 mg/kg (maximum of 80 mg) at Week 2
- d Adalimumab 0.6 mg/kg (maximum of 40 mg) every other week
- e Adalimumab 0.6 mg/kg (maximum of 40 mg) every week

Note 1: Both induction groups received 0.6 mg/kg (maximum of 40 mg) at Week 4 and Week 6

Note 2: Patients with missing values at Week 8 were considered as not having met the endpoints

Note 3: Patients with missing values at Week 52 or who were randomized to receive reinduction or maintenance treatment were considered non-responders for Week 52 endpoints

Of the adalimumab -treated patients who received re-induction treatment during the maintenance period, 2/6 (33 %) achieved clinical response per FMS at Week 52.

Quality of life

Clinically meaningful improvements from Baseline were observed in IMPACT III and the caregiver Work Productivity and Activity Impairment (WPAI) scores for the groups treated with adalimumab.

Clinically meaningful increases (improvement) from Baseline in height velocity were observed for the groups treated with adalimumab, and clinically meaningful increases (improvement) from Baseline in Body Mass Index were observed for subjects on the high maintenance dose of maximum 40 mg (0.6 mg/kg) ew.

Paediatric uveitis

The safety and efficacy of adalimumab was assessed in a randomized, double-masked, controlled study of 90 paediatric patients from 2 to < 18 years of age with active JIA-associated non-infectious anterior uveitis who were refractory to at least 12 weeks of methotrexate treatment. Patients received either placebo or 20 mg adalimumab (if < 30 kg) or 40 mg adalimumab (if ≥ 30 kg) every other week in combination with their baseline dose of methotrexate.

The primary endpoint was ‘time to treatment failure’. The criteria determining treatment failure were worsening or sustained non-improvement in ocular inflammation, partial improvement with development of sustained ocular co-morbidities or worsening of ocular co-morbidities, non-permitted use of concomitant medicinal products, and suspension of treatment for an extended period of time.

Clinical response

Adalimumab significantly delayed the time to treatment failure, as compared to placebo (See Figure 3, $P < 0.0001$ from log rank test). The median time to treatment failure was 24.1 weeks for subjects treated with placebo, whereas the median time to treatment failure was not estimable for subjects treated with adalimumab because less than one-half of these subjects experienced treatment failure. Adalimumab significantly decreased the risk of treatment failure by 75 % relative to placebo, as shown by the hazard ratio (HR = 0.25 [95 % CI: 0.12, 0.49]).

Figure 3: Kaplan-Meier curves summarizing time to treatment failure in the paediatric uveitis study

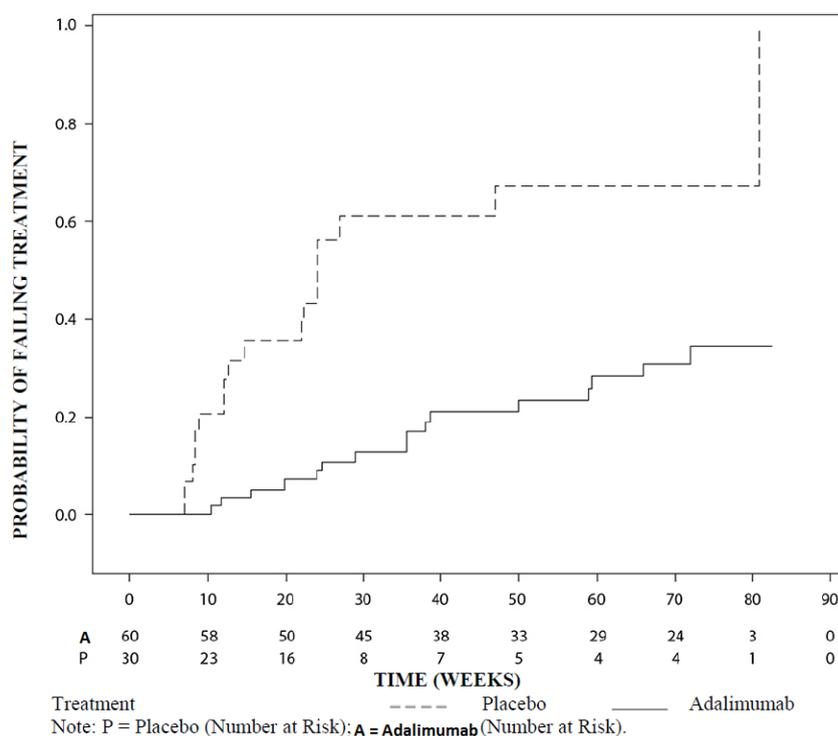

5.2 Pharmacokinetic properties

Absorption and distribution

After subcutaneous administration of a single 40 mg dose, absorption and distribution of adalimumab was slow, with peak serum concentrations being reached about 5 days after administration. The average absolute bioavailability of adalimumab estimated from three studies following a single 40 mg subcutaneous dose was 64 %. After single intravenous doses ranging from 0.25 to 10 mg/kg, concentrations were dose proportional. After doses of 0.5 mg/kg (~40 mg), clearances ranged from 11 to 15 ml/hour, the distribution volume (V_{SS}) ranged from 5 to 6 litres and the mean terminal phase half-life was approximately two weeks. Adalimumab concentrations in the synovial fluid from several rheumatoid arthritis patients ranged from 31–96 % of those in serum.

Following subcutaneous administration of 40 mg of adalimumab every other week in adult rheumatoid arthritis (RA) patients the mean steady-state trough concentrations were approximately 5 µg/ml (without concomitant methotrexate) and 8 to 9 µg/ml (with concomitant methotrexate), respectively. The serum adalimumab trough levels at steady-state increased roughly proportionally with dose following 20, 40 and 80 mg subcutaneous dosing every other week and every week.

Following the administration of 24 mg/m² (a maximum of 40 mg) subcutaneously every other week to patients with polyarticular juvenile idiopathic arthritis (JIA) who were 4 to 17 years the mean trough steady-state (values measured from Week 20 to 48) serum adalimumab concentration was 5.6 ± 5.6 µg/ml (102 % CV) for adalimumab without concomitant methotrexate and 10.9 ± 5.2 µg/ml (47.7 % CV) with concomitant methotrexate.

In patients with polyarticular JIA who were 2 to < 4 years old or aged 4 and above weighing < 15 kg dosed with adalimumab 24 mg/m², the mean trough steady-state serum adalimumab concentrations was 6.0 ± 6.1 µg/ml (101 % CV) for adalimumab without concomitant methotrexate and 7.9 ± 5.6 µg/ml (71.2 % CV) with concomitant methotrexate.

Following the administration of 24 mg/m² (a maximum of 40 mg) subcutaneously every other week to patients with enthesitis-related arthritis who were 6 to 17 years, the mean trough steady-state (values measured at Week 24) serum adalimumab concentrations were 8.8 ± 6.6 µg/ml for adalimumab without concomitant methotrexate and 11.8 ± 4.3 µg/ml with concomitant methotrexate.

Following subcutaneous administration of 40 mg of adalimumab every other week in adult non-radiographic axial spondyloarthritis patients, the mean (±SD) trough steady-state concentration at Week 68 was 8.0 ± 4.6 µg/ml.

In adult patients with psoriasis, the mean steady-state trough concentration was 5 µg/ml during adalimumab 40 mg every other week monotherapy treatment.

Following the administration of 0.8 mg/kg (a maximum of 40 mg) subcutaneously every other week to paediatric patients with chronic plaque psoriasis, the mean ± SD steady-state adalimumab trough concentration was approximately 7.4 ± 5.8 µg/ml (79 % CV).

In adult patients with hidradenitis suppurativa, a dose of 160 mg adalimumab on Week 0 followed by 80 mg on Week 2 achieved serum adalimumab trough concentrations of approximately 7 to 8 µg/ml at Week 2 and Week 4. The mean steady-state trough concentration at Week 12 through Week 36 were approximately 8 to 10 µg/ml during adalimumab 40 mg every week treatment.

Adalimumab exposure in adolescent HS patients was predicted using population pharmacokinetic modelling and simulation based on cross-indication pharmacokinetics in other paediatric patients (paediatric psoriasis, juvenile idiopathic arthritis, paediatric Crohn's disease, and enthesitis-related arthritis). The recommended adolescent HS dosing schedule is 40 mg every other week. Since exposure to adalimumab can be affected by body size, adolescents with higher body weight and inadequate response may benefit from receiving the recommended adult dose of 40 mg every week.

In patients with Crohn's disease, the loading dose of 80 mg adalimumab on Week 0 followed by 40 mg adalimumab on Week 2 achieves serum adalimumab trough concentrations of approximately 5.5 µg/ml during the induction period. A loading dose of 160 mg adalimumab on Week 0 followed by 80 mg adalimumab on Week 2 achieves serum adalimumab trough concentrations of approximately 12 µg/ml during the induction period. Mean steady-state trough levels of approximately 7 µg/ml were observed in Crohn's disease patients who received a maintenance dose of 40 mg adalimumab every other week.

In paediatric patients with moderate to severe CD, the open-label adalimumab induction dose was 160/80 mg or 80/40 mg at Weeks 0 and 2, respectively, dependent on a body weight cut-off of 40 kg. At Week 4, patients were randomised 1:1 to either the Standard Dose (40/20 mg eow) or Low Dose (20/10 mg eow) maintenance treatment groups based on their body weight. The mean (± SD) serum adalimumab trough concentrations achieved at Week 4 were 15.7 ± 6.6 µg/ml for patients ≥ 40 kg (160/80 mg) and 10.6 ± 6.1 µg/ml for patients < 40 kg (80/40 mg).

For patients who stayed on their randomised therapy, the mean (± SD) adalimumab trough concentrations at Week 52 were 9.5 ± 5.6 µg/ml for the Standard Dose group and 3.5 ± 2.2 µg/ml for the Low Dose group. The mean trough concentrations were maintained in patients who continued to receive adalimumab treatment eow for 52 weeks. For patients who dose-escalated from eow to weekly regimen, the mean (± SD) serum concentrations of adalimumab at Week 52 were 15.3 ± 11.4 µg/ml (40/20 mg, weekly) and 6.7 ± 3.5 µg/ml (20/10 mg, weekly).

In patients with ulcerative colitis, a loading dose of 160 mg adalimumab on Week 0 followed by 80 mg adalimumab on Week 2 achieves serum adalimumab trough concentrations of approximately 12 µg/ml during the induction period. Mean steady-state trough levels of approximately 8 µg/ml were observed in ulcerative colitis patients who received a maintenance dose of 40 mg adalimumab every other week.

Following the subcutaneous administration of body weight-based dosing of 0.6 mg/kg (maximum of 40 mg) every other week to paediatric patients with ulcerative colitis, the mean trough steady-state serum adalimumab concentration was 5.01 ± 3.28 µg/ml at Week 52. For patients who received 0.6 mg/kg (maximum of 40 mg) every week, the mean (\pm SD) trough steady-state serum adalimumab concentration was 15.7 ± 5.60 µg/ml at Week 52.

In adult patients with uveitis, a loading dose of 80 mg adalimumab on Week 0 followed by 40 mg adalimumab every other week starting at Week 1, resulted in mean steady-state concentrations of approximately 8 to 10 µg/ml.

Adalimumab exposure in paediatric uveitis patients was predicted using population pharmacokinetic modelling and simulation based on cross-indication pharmacokinetics in other paediatric patients (paediatric psoriasis, juvenile idiopathic arthritis, paediatric Crohn's disease, and enthesitis-related arthritis). No clinical exposure data are available on the use of a loading dose in children < 6 years. The predicted exposures indicate that in the absence of methotrexate, a loading dose may lead to an initial increase in systemic exposure.

Population pharmacokinetic and pharmacokinetic/pharmacodynamic modelling and simulation predicted comparable adalimumab exposure and efficacy in patients treated with 80 mg every other week when compared with 40 mg every week (including adult patients with RA, HS, UC, CD or Ps, patients with adolescent HS, and paediatric patients \geq 40 kg with CD and UC).

Exposure-response relationship in paediatric population

On the basis of clinical study data in patients with JIA (pJIA and ERA), an exposure-response relationship was established between plasma concentrations and PedACR 50 response. The apparent adalimumab plasma concentration that produces half the maximum probability of PedACR 50 response (EC₅₀) was 3 µg/ml (95 % CI: 1-6 µg/ml).

Exposure-response relationships between adalimumab concentration and efficacy in paediatric patients with severe chronic plaque psoriasis were established for PASI 75 and PGA clear or minimal, respectively. PASI 75 and PGA clear or minimal increased with increasing adalimumab concentrations, both with a similar apparent EC₅₀ of approximately 4.5 µg/mL (95 % CI 0.4-47.6 and 1.9-10.5, respectively).

Elimination

Population pharmacokinetic analyses with data from over 1 300 RA patients revealed a trend toward higher apparent clearance of adalimumab with increasing body weight. After adjustment for weight differences, gender and age appeared to have a minimal effect on adalimumab clearance. The serum levels of free adalimumab (not bound to anti-adalimumab antibodies, AAA) were observed to be lower in patients with measurable AAA.

Hepatic or renal impairment

Adalimumab has not been studied in patients with hepatic or renal impairment.

5.3 Preclinical safety data

Non-clinical data reveal no special hazard for humans based on studies of single-dose toxicity, repeated dose toxicity, and genotoxicity.

An embryo-foetal developmental toxicity/perinatal developmental study has been performed in cynomolgus monkeys at 0, 30 and 100 mg/kg (9–17 monkeys/group) and has revealed no evidence of harm to the foetuses due to adalimumab. Neither carcinogenicity studies, nor a standard assessment of fertility and postnatal toxicity, were performed with adalimumab due to the lack of appropriate models for an antibody with limited cross-reactivity to rodent TNF and to the

development of neutralising antibodies in rodents.

6. PHARMACEUTICAL PARTICULARS

6.1 List of excipients

Adipic acid
Mannitol (E 421)
Polysorbate 80 (E 433)
Hydrochloric acid (for pH adjustment) (E 507)
Sodium hydroxide (for pH adjustment) (E 524)
Water for injections

6.2 Incompatibilities

In the absence of compatibility studies, this medicinal product must not be mixed with other medicinal products.

6.3 Shelf life

2 years

6.4 Special precautions for storage

Store in a refrigerator (2°C–8°C). Do not freeze. Keep the pre-filled syringe/pre-filled pen in the outer carton in order to protect from light.

A single Hyrimoz pre-filled syringe/pre-filled pen may be stored at temperatures up to a maximum of 25°C for a period of up to 42 days. The pre-filled syringe/pre-filled pen must be protected from light, and discarded if not used within the 42-day period.

6.5 Nature and contents of container

Hyrimoz 20 mg solution for injection in pre-filled syringe

0.2 ml solution in a single-use clear type I glass syringe with a rubber stopper (bromobutyl rubber) and a stainless steel 29 gauge needle with finger flange, rubber needle cap (thermoplastic elastomer) and plastic plunger.

Multipack containing 2 (2 packs of 1) pre-filled syringes.

Hyrimoz 40 mg solution for injection in pre-filled syringe

0.4 ml solution in a single-use clear type I glass syringe with a rubber stopper (bromobutyl rubber) and a stainless steel 29 gauge needle with an automatic needle guard with finger flange, rubber needle cap (thermoplastic elastomer) and plastic plunger.

Packs of 1 and 2 pre-filled syringes in a blister

Multipack containing 6 (3 packs of 2) pre-filled syringes in a blister

Hyrimoz 40 mg solution for injection in pre-filled pen

0.4 ml solution in a single-use pre-filled syringe assembled into a triangular-shaped pen with transparent window and label. The syringe inside the pen is made of type I glass with a stainless steel 29 gauge needle, an inner rubber needle cap (thermoplastic elastomer), and a rubber stopper (bromobutyl rubber).

Packs of 1, 2 and 4 pre-filled pens
Multipack containing 6 (3 packs of 2) pre-filled pens

Hyrimoz 80 mg solution for injection in pre-filled syringe

0.8 ml solution in a single-use clear type I glass syringe with a rubber stopper (bromobutyl rubber) and a stainless steel 29 gauge needle with an automatic needle guard with finger flange, rubber needle cap (thermoplastic elastomer) and plastic plunger.

Packs of 1 and 2 pre-filled syringes in a blister

Hyrimoz 80 mg solution for injection in pre-filled pen

0.8 ml solution in a single-use pre-filled syringe assembled into a triangular-shaped pen with transparent window and label. The syringe inside the pen is made of type I glass with a stainless steel 29 gauge needle, an inner rubber needle cap (thermoplastic elastomer), and a rubber stopper (bromobutyl rubber).

Packs of 1, 2 and 3 pre-filled pens

Not all pack sizes may be marketed.

6.6 Special precautions for disposal

Any unused medicinal product or waste material should be disposed of in accordance with local requirements.

Full instructions for use are given in the package leaflet, section 7, "Instructions for Use".

7. MARKETING AUTHORISATION HOLDER

Sandoz GmbH
Biochemiestr. 10
6250 Kundl
Austria

8. MARKETING AUTHORISATION NUMBERS

Hyrimoz 20 mg solution for injection in pre-filled syringe

EU/1/18/1286/019

Hyrimoz 40 mg solution for injection in pre-filled syringe

EU/1/18/1286/012
EU/1/18/1286/013
EU/1/18/1286/014

Hyrimoz 40 mg solution for injection in pre-filled pen

EU/1/18/1286/015
EU/1/18/1286/016
EU/1/18/1286/017
EU/1/18/1286/018

Hyrimoz 80 mg solution for injection in pre-filled syringe

EU/1/18/1286/008

EU/1/18/1286/009

Hyrimoz 80 mg solution for injection in pre-filled pen

EU/1/18/1286/010

EU/1/18/1286/011

EU/1/18/1286/020

9. DATE OF FIRST AUTHORISATION/RENEWAL OF THE AUTHORISATION

Date of first authorisation: 26 July 2018

Date of latest renewal: 15 February 2023

10. DATE OF REVISION OF THE TEXT

Detailed information on this medicinal product is available on the website of the European Medicines Agency <https://www.ema.europa.eu>.

ANNEX II

- A. MANUFACTURERS OF THE BIOLOGICAL ACTIVE
SUBSTANCE AND MANUFACTURERS
RESPONSIBLE FOR BATCH RELEASE**
- B. CONDITIONS OR RESTRICTIONS REGARDING
SUPPLY AND USE**
- C. OTHER CONDITIONS AND REQUIREMENTS OF
THE MARKETING AUTHORISATION**
- D. CONDITIONS OR RESTRICTIONS WITH REGARD
TO THE SAFE AND EFFECTIVE USE OF THE
MEDICINAL PRODUCT**

A. MANUFACTURERS OF THE BIOLOGICAL ACTIVE SUBSTANCE AND MANUFACTURERS RESPONSIBLE FOR BATCH RELEASE

Name and address of the manufacturers of the biological active substance

Novartis Pharmaceutical Manufacturing GmbH
Biochemiestrasse 10
6336 Langkampfen
Austria

Novartis Pharmaceutical Manufacturing LLC
Kolodvorska Cesta 27
1234 Mengeš
Slovenia

Name and address of the manufacturers responsible for batch release

Sandoz GmbH
Biochemiestrasse 10
6336 Langkampfen
Austria

Novartis Pharmaceutical Manufacturing GmbH
Biochemiestrasse 10
6336 Langkampfen
Austria

The printed package leaflet of the medicinal product must state the name and address of the manufacturer responsible for the release of the concerned batch.

B. CONDITIONS OR RESTRICTIONS REGARDING SUPPLY AND USE

Medicinal product subject to restricted medical prescription (see Annex I: Summary of Product Characteristics, section 4.2).

C. OTHER CONDITIONS AND REQUIREMENTS OF THE MARKETING AUTHORISATION

- **Periodic safety update reports (PSURs)**

The requirements for submission of PSURs for this medicinal product are set out in the list of Union reference dates (EURD list) provided for under Article 107c(7) of Directive 2001/83/EC and any subsequent updates published on the European medicines web-portal.

D. CONDITIONS OR RESTRICTIONS WITH REGARD TO THE SAFE AND EFFECTIVE USE OF THE MEDICINAL PRODUCT

- **Risk management plan (RMP)**

The marketing authorisation holder (MAH) shall perform the required pharmacovigilance activities and interventions detailed in the agreed RMP presented in Module 1.8.2 of the marketing authorisation and any agreed subsequent updates of the RMP.

An updated RMP should be submitted:

- At the request of the European Medicines Agency;
- Whenever the risk management system is modified, especially as the result of new information being received that may lead to a significant change to the benefit/risk profile or as the result of an important (pharmacovigilance or risk minimisation) milestone being reached.
- **Additional risk minimisation measures**

The Patient Reminder Cards (adult and paediatric) contain the following key elements:

- infections, including tuberculosis
- cancer
- nervous system problems
- vaccinations

ANNEX III
LABELLING AND PACKAGE LEAFLET

A. LABELLING

PARTICULARS TO APPEAR ON THE OUTER PACKAGING

OUTER CARTON OF UNIT PACK

1. NAME OF THE MEDICINAL PRODUCT

Hyrimoz 20 mg solution for injection in pre-filled syringe
adalimumab

2. STATEMENT OF ACTIVE SUBSTANCE

One 0.4 ml pre-filled syringe contains 20 mg adalimumab.

3. LIST OF EXCIPIENTS

Excipients: adipic acid, citric acid monohydrate, sodium chloride, mannitol, polysorbate 80, hydrochloric acid, sodium hydroxide, water for injections.

4. PHARMACEUTICAL FORM AND CONTENTS

solution for injection
20 mg/0.4 ml
2 pre-filled syringes

5. METHOD AND ROUTE(S) OF ADMINISTRATION

Read the package leaflet before use.
Subcutaneous use.
For single use only.

6. SPECIAL WARNING THAT THE MEDICINAL PRODUCT MUST BE STORED OUT OF THE SIGHT AND REACH OF CHILDREN

Keep out of the sight and reach of children.

7. OTHER SPECIAL WARNING, IF NECESSARY

8. EXPIRY DATE

EXP

9. SPECIAL STORAGE CONDITIONS

Store in a refrigerator.
Do not freeze.

Keep the pre-filled syringes in the outer carton in order to protect from light.

10. SPECIAL PRECAUTIONS FOR DISPOSAL OF UNUSED MEDICINAL PRODUCTS OR WASTE MATERIALS DERIVED FROM SUCH MEDICINAL PRODUCTS, IF APPROPRIATE

11. NAME AND ADDRESS OF THE MARKETING AUTHORISATION HOLDER

Sandoz GmbH
Biochemiestr. 10
A-6250 Kundl
Austria

12. MARKETING AUTHORISATION NUMBER(S)

EU/1/18/1286/007 2 pre-filled syringes

13. BATCH NUMBER

Lot

14. GENERAL CLASSIFICATION FOR SUPPLY

15. INSTRUCTIONS ON USE

16. INFORMATION IN BRAILLE

Hyrimoz 20 mg/0.4 ml

17. UNIQUE IDENTIFIER – 2D BARCODE

2D barcode carrying the unique identifier included.

18. UNIQUE IDENTIFIER - HUMAN READABLE DATA

PC
SN
NN

MINIMUM PARTICULARS TO APPEAR ON BLISTERS OR STRIPS

BLISTER TEXT

1. NAME OF THE MEDICINAL PRODUCT

Hyrimoz 20 mg injection
adalimumab

2. NAME OF THE MARKETING AUTHORISATION HOLDER

SANDOZ

3. EXPIRY DATE

EXP

4. BATCH NUMBER

Lot

5. OTHER

SC
20 mg/0.4 ml

**MINIMUM PARTICULARS TO APPEAR ON SMALL IMMEDIATE PACKAGING UNITS
SYRINGE LABEL**

1. NAME OF THE MEDICINAL PRODUCT AND ROUTE(S) OF ADMINISTRATION

Hyrimoz 20 mg injection
adalimumab
SC

2. METHOD OF ADMINISTRATION

3. EXPIRY DATE

EXP

4. BATCH NUMBER

Lot

5. CONTENTS BY WEIGHT, BY VOLUME OR BY UNIT

6. OTHER

0.4 ml

PARTICULARS TO APPEAR ON THE OUTER PACKAGING

OUTER CARTON OF MULTIPACK (INCLUDING BLUE BOX)

1. NAME OF THE MEDICINAL PRODUCT

Hyrimoz 20 mg solution for injection in pre-filled syringe
adalimumab

2. STATEMENT OF ACTIVE SUBSTANCE

One 0.2 ml pre-filled syringe contains 20 mg adalimumab.

3. LIST OF EXCIPIENTS

Excipients: adipic acid, mannitol, polysorbate 80, hydrochloric acid, sodium hydroxide, water for injections.

4. PHARMACEUTICAL FORM AND CONTENTS

solution for injection
20 mg/0.2 ml

Multipack: 2 (2 packs of 1) pre-filled syringes

5. METHOD AND ROUTE OF ADMINISTRATION

Read the package leaflet before use.
Subcutaneous use.
For single use only.

6. SPECIAL WARNING THAT THE MEDICINAL PRODUCT MUST BE STORED OUT OF THE SIGHT AND REACH OF CHILDREN

Keep out of the sight and reach of children.

7. OTHER SPECIAL WARNING(S), IF NECESSARY

8. EXPIRY DATE

EXP

9. SPECIAL STORAGE CONDITIONS

Store in a refrigerator.
Do not freeze.

Keep the pre-filled syringes in the outer carton in order to protect from light.

10. SPECIAL PRECAUTIONS FOR DISPOSAL OF UNUSED MEDICINAL PRODUCTS OR WASTE MATERIALS DERIVED FROM SUCH MEDICINAL PRODUCTS, IF APPROPRIATE

11. NAME AND ADDRESS OF THE MARKETING AUTHORISATION HOLDER

Sandoz GmbH
Biochemiestr. 10
A-6250 Kundl
Austria

12. MARKETING AUTHORISATION NUMBER(S)

EU/1/18/1286/019 2 pre-filled syringes (2 packs of 1)

13. BATCH NUMBER

Lot

14. GENERAL CLASSIFICATION FOR SUPPLY

15. INSTRUCTIONS ON USE

16. INFORMATION IN BRAILLE

Hyrimoz 20 mg/0.2 ml

17. UNIQUE IDENTIFIER – 2D BARCODE

2D barcode carrying the unique identifier included.

18. UNIQUE IDENTIFIER - HUMAN READABLE DATA

PC
SN
NN

PARTICULARS TO APPEAR ON THE OUTER PACKAGING

INNER CARTON OF MULTIPACK (WITHOUT BLUE BOX)

1. NAME OF THE MEDICINAL PRODUCT

Hyrimoz 20 mg solution for injection in pre-filled syringe
adalimumab

2. STATEMENT OF ACTIVE SUBSTANCE

One 0.2 ml pre-filled syringe contains 20 mg adalimumab.

3. LIST OF EXCIPIENTS

Excipients: adipic acid, mannitol, polysorbate 80, hydrochloric acid, sodium hydroxide, water for injections.

4. PHARMACEUTICAL FORM AND CONTENTS

solution for injection
20 mg/0.2 ml
1 pre-filled syringe
Component of a multipack, cannot be sold separately.

5. METHOD AND ROUTE OF ADMINISTRATION

Read the package leaflet before use.
Subcutaneous use.
For single use only.

Open here

6. SPECIAL WARNING THAT THE MEDICINAL PRODUCT MUST BE STORED OUT OF THE SIGHT AND REACH OF CHILDREN

Keep out of the sight and reach of children.

7. OTHER SPECIAL WARNING(S), IF NECESSARY

8. EXPIRY DATE

EXP

9. SPECIAL STORAGE CONDITIONS

Store in a refrigerator.
Do not freeze.

Keep the pre-filled syringe in the outer carton in order to protect from light.

10. SPECIAL PRECAUTIONS FOR DISPOSAL OF UNUSED MEDICINAL PRODUCTS OR WASTE MATERIALS DERIVED FROM SUCH MEDICINAL PRODUCTS, IF APPROPRIATE**11. NAME AND ADDRESS OF THE MARKETING AUTHORISATION HOLDER**

Sandoz GmbH
Biochemiestr. 10
A-6250 Kundl
Austria

12. MARKETING AUTHORISATION NUMBER(S)

EU/1/18/1286/019 2 pre-filled syringes (2 packs of 1)

13. BATCH NUMBER

Lot

14. GENERAL CLASSIFICATION FOR SUPPLY**15. INSTRUCTIONS ON USE****16. INFORMATION IN BRAILLE**

Hyrimoz 20 mg/0.2 ml

17. UNIQUE IDENTIFIER – 2D BARCODE**18. UNIQUE IDENTIFIER - HUMAN READABLE DATA**

**MINIMUM PARTICULARS TO APPEAR ON SMALL IMMEDIATE PACKAGING UNITS
SYRINGE LABEL**

1. NAME OF THE MEDICINAL PRODUCT AND ROUTE(S) OF ADMINISTRATION

Hyrimoz 20 mg injection
adalimumab
SC

2. METHOD OF ADMINISTRATION

3. EXPIRY DATE

EXP

4. BATCH NUMBER

Lot

5. CONTENTS BY WEIGHT, BY VOLUME OR BY UNIT

6. OTHER

0.2 ml

**PARTICULARS TO APPEAR ON THE OUTER PACKAGING
OUTER CARTON OF UNIT PACK**

1. NAME OF THE MEDICINAL PRODUCT

Hyrimoz 40 mg solution for injection in pre-filled syringe
adalimumab

2. STATEMENT OF ACTIVE SUBSTANCE

One 0.8 ml pre-filled syringe contains 40 mg adalimumab.

3. LIST OF EXCIPIENTS

Excipients: adipic acid, citric acid monohydrate, sodium chloride, mannitol, polysorbate 80,
hydrochloric acid, sodium hydroxide, water for injections.

4. PHARMACEUTICAL FORM AND CONTENTS

solution for injection
40 mg/0.8 ml

1 pre-filled syringe

2 pre-filled syringes

5. METHOD AND ROUTE(S) OF ADMINISTRATION

Read the package leaflet before use.
Subcutaneous use.
For single use only.

**6. SPECIAL WARNING THAT THE MEDICINAL PRODUCT MUST BE STORED OUT
OF THE SIGHT AND REACH OF CHILDREN**

Keep out of the sight and reach of children.

7. OTHER SPECIAL WARNING, IF NECESSARY

8. EXPIRY DATE

EXP

9. SPECIAL STORAGE CONDITIONS

Store in a refrigerator.
Do not freeze.

Keep the pre-filled syringe in the outer carton in order to protect from light.
Keep the pre-filled syringes in the outer carton in order to protect from light.

10. SPECIAL PRECAUTIONS FOR DISPOSAL OF UNUSED MEDICINAL PRODUCTS OR WASTE MATERIALS DERIVED FROM SUCH MEDICINAL PRODUCTS, IF APPROPRIATE

11. NAME AND ADDRESS OF THE MARKETING AUTHORISATION HOLDER

Sandoz GmbH
Biochemiestr. 10
A-6250 Kundl
Austria

12. MARKETING AUTHORISATION NUMBER(S)

EU/1/18/1286/001 1 pre-filled syringe
EU/1/18/1286/002 2 pre-filled syringes

13. BATCH NUMBER

Lot

14. GENERAL CLASSIFICATION FOR SUPPLY

15. INSTRUCTIONS ON USE

16. INFORMATION IN BRAILLE

Hyrimoz 40 mg/0.8 ml

17. UNIQUE IDENTIFIER – 2D BARCODE

2D barcode carrying the unique identifier included.

18. UNIQUE IDENTIFIER - HUMAN READABLE DATA

PC
SN
NN

**PARTICULARS TO APPEAR ON THE OUTER PACKAGING
OUTER CARTON OF MULTIPACK (INCLUDING BLUE BOX)**

1. NAME OF THE MEDICINAL PRODUCT

Hyrimoz 40 mg solution for injection in pre-filled syringe
adalimumab

2. STATEMENT OF ACTIVE SUBSTANCE

One 0.8 ml pre-filled syringe contains 40 mg adalimumab.

3. LIST OF EXCIPIENTS

Excipients: adipic acid, citric acid monohydrate, sodium chloride, mannitol, polysorbate 80,
hydrochloric acid, sodium hydroxide, water for injections.

4. PHARMACEUTICAL FORM AND CONTENTS

solution for injection
40 mg/0.8 ml

Multipack: 6 (3 packs of 2) pre-filled syringes

5. METHOD AND ROUTE(S) OF ADMINISTRATION

Read the package leaflet before use.
Subcutaneous use.
For single use only.

**6. SPECIAL WARNING THAT THE MEDICINAL PRODUCT MUST BE STORED OUT
OF THE SIGHT AND REACH OF CHILDREN**

Keep out of the sight and reach of children.

7. OTHER SPECIAL WARNING, IF NECESSARY

8. EXPIRY DATE

EXP

9. SPECIAL STORAGE CONDITIONS

Store in a refrigerator.
Do not freeze.

Keep the pre-filled syringes in the outer carton in order to protect from light.

10. SPECIAL PRECAUTIONS FOR DISPOSAL OF UNUSED MEDICINAL PRODUCTS OR WASTE MATERIALS DERIVED FROM SUCH MEDICINAL PRODUCTS, IF APPROPRIATE

11. NAME AND ADDRESS OF THE MARKETING AUTHORISATION HOLDER

Sandoz GmbH
Biochemiestr. 10
A-6250 Kundl
Austria

12. MARKETING AUTHORISATION NUMBER(S)

EU/1/18/1286/003 6 pre-filled syringes (3 packs of 2)

13. BATCH NUMBER

Lot

14. GENERAL CLASSIFICATION FOR SUPPLY

15. INSTRUCTIONS ON USE

16. INFORMATION IN BRAILLE

Hyrimoz 40 mg/0.8 ml

17. UNIQUE IDENTIFIER – 2D BARCODE

2D barcode carrying the unique identifier included.

18. UNIQUE IDENTIFIER - HUMAN READABLE DATA

PC
SN
NN

PARTICULARS TO APPEAR ON THE OUTER PACKAGING

INNER CARTON OF MULTIPACK (WITHOUT BLUE BOX)

1. NAME OF THE MEDICINAL PRODUCT

Hyrimoz 40 mg solution for injection in pre-filled syringe
adalimumab

2. STATEMENT OF ACTIVE SUBSTANCE

One 0.8 ml pre-filled syringe contains 40 mg adalimumab.

3. LIST OF EXCIPIENTS

Excipients: adipic acid, citric acid monohydrate, sodium chloride, mannitol, polysorbate 80, hydrochloric acid, sodium hydroxide, water for injections.

4. PHARMACEUTICAL FORM AND CONTENTS

solution for injection
40 mg/0.8 ml

2 pre-filled syringes

Component of a multipack, cannot be sold separately.

5. METHOD AND ROUTE(S) OF ADMINISTRATION

Read the package leaflet before use.
Subcutaneous use.
For single use only.

6. SPECIAL WARNING THAT THE MEDICINAL PRODUCT MUST BE STORED OUT OF THE SIGHT AND REACH OF CHILDREN

Keep out of the sight and reach of children.

7. OTHER SPECIAL WARNING, IF NECESSARY

8. EXPIRY DATE

EXP

9. SPECIAL STORAGE CONDITIONS

Store in a refrigerator.
Do not freeze.

Keep the pre-filled syringes in the outer carton in order to protect from light.

10. SPECIAL PRECAUTIONS FOR DISPOSAL OF UNUSED MEDICINAL PRODUCTS OR WASTE MATERIALS DERIVED FROM SUCH MEDICINAL PRODUCTS, IF APPROPRIATE**11. NAME AND ADDRESS OF THE MARKETING AUTHORISATION HOLDER**

Sandoz GmbH
Biochemiestr. 10
A-6250 Kundl
Austria

12. MARKETING AUTHORISATION NUMBER(S)

EU/1/18/1286/003 6 pre-filled syringes (3 packs of 2)

13. BATCH NUMBER

Lot

14. GENERAL CLASSIFICATION FOR SUPPLY**15. INSTRUCTIONS ON USE****16. INFORMATION IN BRAILLE**

Hyrimoz 40 mg/0.8 ml

17. UNIQUE IDENTIFIER – 2D BARCODE**18. UNIQUE IDENTIFIER - HUMAN READABLE DATA**

MINIMUM PARTICULARS TO APPEAR ON BLISTERS OR STRIPS

BLISTER TEXT

1. NAME OF THE MEDICINAL PRODUCT

Hyrimoz 40 mg injection
adalimumab

2. NAME OF THE MARKETING AUTHORISATION HOLDER

SANDOZ

3. EXPIRY DATE

EXP

4. BATCH NUMBER

Lot

5. OTHER

SC
40 mg/0.8 ml

MINIMUM PARTICULARS TO APPEAR ON SMALL IMMEDIATE PACKAGING UNITS
SYRINGE LABEL

1. NAME OF THE MEDICINAL PRODUCT AND ROUTE(S) OF ADMINISTRATION

Hyrimoz 40 mg injection
adalimumab
SC

2. METHOD OF ADMINISTRATION

3. EXPIRY DATE

EXP

4. BATCH NUMBER

Lot

5. CONTENTS BY WEIGHT, BY VOLUME OR BY UNIT

6. OTHER

0.8 ml

PARTICULARS TO APPEAR ON THE OUTER PACKAGING

OUTER CARTON OF UNIT PACK

1. NAME OF THE MEDICINAL PRODUCT

Hyrimoz 40 mg solution for injection in pre-filled pen
adalimumab

2. STATEMENT OF ACTIVE SUBSTANCE

One 0.8 ml pre-filled pen contains 40 mg adalimumab.

3. LIST OF EXCIPIENTS

Excipients: adipic acid, citric acid monohydrate, sodium chloride, mannitol, polysorbate 80, hydrochloric acid, sodium hydroxide, water for injections.

4. PHARMACEUTICAL FORM AND CONTENTS

solution for injection
40 mg/0.8 ml

1 pre-filled pen (SensoReady)

2 pre-filled pens (SensoReady)

5. METHOD AND ROUTE(S) OF ADMINISTRATION

Read the package leaflet before use.
Subcutaneous use.
For single use only.

6. SPECIAL WARNING THAT THE MEDICINAL PRODUCT MUST BE STORED OUT OF THE SIGHT AND REACH OF CHILDREN

Keep out of the sight and reach of children.

7. OTHER SPECIAL WARNING, IF NECESSARY

8. EXPIRY DATE

EXP

9. SPECIAL STORAGE CONDITIONS

Store in a refrigerator.
Do not freeze.

Keep the pre-filled pen in the outer carton in order to protect from light.
Keep the pre-filled pens in the outer carton in order to protect from light.

10. SPECIAL PRECAUTIONS FOR DISPOSAL OF UNUSED MEDICINAL PRODUCTS OR WASTE MATERIALS DERIVED FROM SUCH MEDICINAL PRODUCTS, IF APPROPRIATE

11. NAME AND ADDRESS OF THE MARKETING AUTHORISATION HOLDER

Sandoz GmbH
Biochemiestr. 10
A-6250 Kundl
Austria

12. MARKETING AUTHORISATION NUMBER(S)

EU/1/18/1286/004 1 pre-filled pen
EU/1/18/1286/005 2 pre-filled pens

13. BATCH NUMBER

Lot

14. GENERAL CLASSIFICATION FOR SUPPLY

15. INSTRUCTIONS ON USE

16. INFORMATION IN BRAILLE

Hyrimoz 40 mg/0.8 ml

17. UNIQUE IDENTIFIER – 2D BARCODE

2D barcode carrying the unique identifier included.

18. UNIQUE IDENTIFIER – HUMAN READABLE DATA

PC

SN
NN

PARTICULARS TO APPEAR ON THE OUTER PACKAGING

OUTER CARTON OF MULTIPACK (INCLUDING BLUE BOX)

1. NAME OF THE MEDICINAL PRODUCT

Hyrimoz 40 mg solution for injection in pre-filled pen
adalimumab

2. STATEMENT OF ACTIVE SUBSTANCE

One 0.8 ml pre-filled pen contains 40 mg adalimumab.

3. LIST OF EXCIPIENTS

Excipients: adipic acid, citric acid monohydrate, sodium chloride, mannitol, polysorbate 80, hydrochloric acid, sodium hydroxide, water for injections.

4. PHARMACEUTICAL FORM AND CONTENTS

solution for injection
40 mg/0.8 ml

Multipack: 6 (3 packs of 2) pre-filled pens (SensoReady)

5. METHOD AND ROUTE(S) OF ADMINISTRATION

Read the package leaflet before use.
Subcutaneous use.
For single use only.

6. SPECIAL WARNING THAT THE MEDICINAL PRODUCT MUST BE STORED OUT OF THE SIGHT AND REACH OF CHILDREN

Keep out of the sight and reach of children.

7. OTHER SPECIAL WARNING, IF NECESSARY

8. EXPIRY DATE

EXP

9. SPECIAL STORAGE CONDITIONS

Store in a refrigerator.
Do not freeze.

Keep the pre-filled pens in the outer carton in order to protect from light.

10. SPECIAL PRECAUTIONS FOR DISPOSAL OF UNUSED MEDICINAL PRODUCTS OR WASTE MATERIALS DERIVED FROM SUCH MEDICINAL PRODUCTS, IF APPROPRIATE

11. NAME AND ADDRESS OF THE MARKETING AUTHORISATION HOLDER

Sandoz GmbH
Biochemiestr. 10
A-6250 Kundl
Austria

12. MARKETING AUTHORISATION NUMBER(S)

EU/1/18/1286/006 6 pre-filled pens (3 packs of 2)

13. BATCH NUMBER

Lot

14. GENERAL CLASSIFICATION FOR SUPPLY

15. INSTRUCTIONS ON USE

16. INFORMATION IN BRAILLE

Hyrimoz 40 mg/0.8 ml

17. UNIQUE IDENTIFIER – 2D BARCODE

2D barcode carrying the unique identifier included

18. UNIQUE IDENTIFIER - HUMAN READABLE DATA

PC
SN
NN

PARTICULARS TO APPEAR ON THE OUTER PACKAGING

INNER CARTON OF MULTIPACK (WITHOUT BLUE BOX)

1. NAME OF THE MEDICINAL PRODUCT

Hyrimoz 40 mg solution for injection in pre-filled pen
adalimumab

2. STATEMENT OF ACTIVE SUBSTANCE

One 0.8 ml pre-filled pen contains 40 mg adalimumab.

3. LIST OF EXCIPIENTS

Excipients: adipic acid, citric acid monohydrate, sodium chloride, mannitol, polysorbate 80, hydrochloric acid, sodium hydroxide, water for injections.

4. PHARMACEUTICAL FORM AND CONTENTS

solution for injection
40 mg/0.8 ml

2 pre-filled pens (SensoReady)

Component of a multipack, cannot be sold separately.

5. METHOD AND ROUTE(S) OF ADMINISTRATION

Read the package leaflet before use.
Subcutaneous use.
For single use only.

6. SPECIAL WARNING THAT THE MEDICINAL PRODUCT MUST BE STORED OUT OF THE SIGHT AND REACH OF CHILDREN

Keep out of the sight and reach of children.

7. OTHER SPECIAL WARNING, IF NECESSARY

8. EXPIRY DATE

EXP

9. SPECIAL STORAGE CONDITIONS

Store in a refrigerator.
Do not freeze.

Keep the pre-filled pens in the outer carton in order to protect from light.

10. SPECIAL PRECAUTIONS FOR DISPOSAL OF UNUSED MEDICINAL PRODUCTS OR WASTE MATERIALS DERIVED FROM SUCH MEDICINAL PRODUCTS, IF APPROPRIATE**11. NAME AND ADDRESS OF THE MARKETING AUTHORISATION HOLDER**

Sandoz GmbH
Biochemiestr. 10
A-6250 Kundl
Austria

12. MARKETING AUTHORISATION NUMBER(S)

EU/1/18/1286/006 6 pre-filled pens (3 packs of 2)

13. BATCH NUMBER

Lot

14. GENERAL CLASSIFICATION FOR SUPPLY**15. INSTRUCTIONS ON USE****16. INFORMATION IN BRAILLE**

Hyrimoz 40 mg/0.8 ml

17. UNIQUE IDENTIFIER – 2D BARCODE**18. UNIQUE IDENTIFIER - HUMAN READABLE DATA**

MINIMUM PARTICULARS TO APPEAR ON SMALL IMMEDIATE PACKAGING UNITS

PEN LABEL

1. NAME OF THE MEDICINAL PRODUCT AND ROUTE(S) OF ADMINISTRATION

Hyrimoz 40 mg injection
adalimumab
SC

2. METHOD OF ADMINISTRATION

3. EXPIRY DATE

EXP

4. BATCH NUMBER

Lot

5. CONTENTS BY WEIGHT, BY VOLUME OR BY UNIT

6. OTHER

0.8 ml

PARTICULARS TO APPEAR ON THE OUTER PACKAGING

OUTER CARTON OF UNIT PACK

1. NAME OF THE MEDICINAL PRODUCT

Hyrimoz 40 mg solution for injection in pre-filled syringe
adalimumab

2. STATEMENT OF ACTIVE SUBSTANCE(S)

One 0.4 ml pre-filled syringe contains 40 mg adalimumab.

3. LIST OF EXCIPIENTS

Excipients: adipic acid, mannitol, polysorbate 80, hydrochloric acid, sodium hydroxide, water for injections.

4. PHARMACEUTICAL FORM AND CONTENTS

solution for injection
40 mg/0.4 ml

1 pre-filled syringe
2 pre-filled syringes

5. METHOD AND ROUTE(S) OF ADMINISTRATION

Read the package leaflet before use.
Subcutaneous use.
For single use only.

6. SPECIAL WARNING THAT THE MEDICINAL PRODUCT MUST BE STORED OUT OF THE SIGHT AND REACH OF CHILDREN

Keep out of the sight and reach of children.

7. OTHER SPECIAL WARNING(S), IF NECESSARY

8. EXPIRY DATE

EXP

9. SPECIAL STORAGE CONDITIONS

Store in a refrigerator.
Do not freeze.

Keep the pre-filled syringe in the outer carton in order to protect from light.
Keep the pre-filled syringes in the outer carton in order to protect from light.

10. SPECIAL PRECAUTIONS FOR DISPOSAL OF UNUSED MEDICINAL PRODUCTS OR WASTE MATERIALS DERIVED FROM SUCH MEDICINAL PRODUCTS, IF APPROPRIATE

11. NAME AND ADDRESS OF THE MARKETING AUTHORISATION HOLDER

Sandoz GmbH
Biochemiestr. 10
A-6250 Kundl
Austria

12. MARKETING AUTHORISATION NUMBER(S)

EU/1/18/1286/012 1 pre-filled syringe
EU/1/18/1286/013 2 pre-filled syringes

13. BATCH NUMBER

Lot

14. GENERAL CLASSIFICATION FOR SUPPLY

15. INSTRUCTIONS ON USE

16. INFORMATION IN BRAILLE

Hyrimoz 40 mg/0.4 ml

17. UNIQUE IDENTIFIER – 2D BARCODE

2D barcode carrying the unique identifier included.

18. UNIQUE IDENTIFIER - HUMAN READABLE DATA

PC
SN
NN

PARTICULARS TO APPEAR ON THE OUTER PACKAGING

OUTER CARTON OF MULTIPACK (INCLUDING BLUE BOX)

1. NAME OF THE MEDICINAL PRODUCT

Hyrimoz 40 mg solution for injection in pre-filled syringe
adalimumab

2. STATEMENT OF ACTIVE SUBSTANCE(S)

One 0.4 ml pre-filled syringe contains 40 mg adalimumab.

3. LIST OF EXCIPIENTS

Excipients: adipic acid, mannitol, polysorbate 80, hydrochloric acid, sodium hydroxide, water for injections.

4. PHARMACEUTICAL FORM AND CONTENTS

solution for injection
40 mg/0.4 ml

Multipack: 6 (3 packs of 2) pre-filled syringes

5. METHOD AND ROUTE(S) OF ADMINISTRATION

Read the package leaflet before use.
Subcutaneous use.
For single use only.

6. SPECIAL WARNING THAT THE MEDICINAL PRODUCT MUST BE STORED OUT OF THE SIGHT AND REACH OF CHILDREN

Keep out of the sight and reach of children.

7. OTHER SPECIAL WARNING(S), IF NECESSARY

8. EXPIRY DATE

EXP

9. SPECIAL STORAGE CONDITIONS

Store in a refrigerator.
Do not freeze.

Keep the pre-filled syringes in the outer carton in order to protect from light.

10. SPECIAL PRECAUTIONS FOR DISPOSAL OF UNUSED MEDICINAL PRODUCTS OR WASTE MATERIALS DERIVED FROM SUCH MEDICINAL PRODUCTS, IF APPROPRIATE

11. NAME AND ADDRESS OF THE MARKETING AUTHORISATION HOLDER

Sandoz GmbH
Biochemiestr. 10
A-6250 Kundl
Austria

12. MARKETING AUTHORISATION NUMBER(S)

EU/1/18/1286/014 6 pre-filled syringes (3 packs of 2)

13. BATCH NUMBER

Lot

14. GENERAL CLASSIFICATION FOR SUPPLY

15. INSTRUCTIONS ON USE

16. INFORMATION IN BRAILLE

Hyrimoz 40 mg/0.4 ml

17. UNIQUE IDENTIFIER – 2D BARCODE

2D barcode carrying the unique identifier included.

18. UNIQUE IDENTIFIER - HUMAN READABLE DATA

PC
SN
NN

PARTICULARS TO APPEAR ON THE OUTER PACKAGING

INNER CARTON OF MULTIPACK (WITHOUT BLUE BOX)

1. NAME OF THE MEDICINAL PRODUCT

Hyrimoz 40 mg solution for injection in pre-filled syringe
adalimumab

2. STATEMENT OF ACTIVE SUBSTANCE(S)

One 0.4 ml pre-filled syringe contains 40 mg adalimumab.

3. LIST OF EXCIPIENTS

Excipients: adipic acid, mannitol, polysorbate 80, hydrochloric acid, sodium hydroxide, water for injections.

4. PHARMACEUTICAL FORM AND CONTENTS

solution for injection
40 mg/0.4 ml

2 pre-filled syringes
Component of a multipack, cannot be sold separately.

5. METHOD AND ROUTE(S) OF ADMINISTRATION

Read the package leaflet before use.
Subcutaneous use.
For single use only.

6. SPECIAL WARNING THAT THE MEDICINAL PRODUCT MUST BE STORED OUT OF THE SIGHT AND REACH OF CHILDREN

Keep out of the sight and reach of children.

7. OTHER SPECIAL WARNING(S), IF NECESSARY

8. EXPIRY DATE

EXP

9. SPECIAL STORAGE CONDITIONS

Store in a refrigerator.
Do not freeze.

Keep the pre-filled syringes in the outer carton in order to protect from light.

10. SPECIAL PRECAUTIONS FOR DISPOSAL OF UNUSED MEDICINAL PRODUCTS OR WASTE MATERIALS DERIVED FROM SUCH MEDICINAL PRODUCTS, IF APPROPRIATE

11. NAME AND ADDRESS OF THE MARKETING AUTHORISATION HOLDER

Sandoz GmbH
Biochemiestr. 10
A-6250 Kundl
Austria

12. MARKETING AUTHORISATION NUMBER(S)

EU/1/18/1286/014 6 pre-filled syringes (3 packs of 2)

13. BATCH NUMBER

Lot

14. GENERAL CLASSIFICATION FOR SUPPLY

15. INSTRUCTIONS ON USE

16. INFORMATION IN BRAILLE

Hyrimoz 40 mg/0.4 ml

17. UNIQUE IDENTIFIER – 2D BARCODE

18. UNIQUE IDENTIFIER - HUMAN READABLE DATA

MINIMUM PARTICULARS TO APPEAR ON BLISTERS OR STRIPS

BLISTER TEXT

1. NAME OF THE MEDICINAL PRODUCT

Hyrimoz 40 mg injection
adalimumab

2. NAME OF THE MARKETING AUTHORISATION HOLDER

SANDOZ

3. EXPIRY DATE

EXP

4. BATCH NUMBER

Lot

5. OTHER

SC
40 mg/0.4 ml

**MINIMUM PARTICULARS TO APPEAR ON SMALL IMMEDIATE PACKAGING UNITS
SYRINGE LABEL**

1. NAME OF THE MEDICINAL PRODUCT AND ROUTE(S) OF ADMINISTRATION

Hyrimoz 40 mg injection
adalimumab
SC

2. METHOD OF ADMINISTRATION

3. EXPIRY DATE

EXP

4. BATCH NUMBER

Lot

5. CONTENTS BY WEIGHT, BY VOLUME OR BY UNIT

6. OTHER

0.4 ml

PARTICULARS TO APPEAR ON THE OUTER PACKAGING

OUTER CARTON OF UNIT PACK

1. NAME OF THE MEDICINAL PRODUCT

Hyrimoz 40 mg solution for injection in pre-filled pen
adalimumab

2. STATEMENT OF ACTIVE SUBSTANCE

One 0.4 ml pre-filled pen contains 40 mg adalimumab.

3. LIST OF EXCIPIENTS

Excipients: adipic acid, mannitol, polysorbate 80, hydrochloric acid, sodium hydroxide, water for injections.

4. PHARMACEUTICAL FORM AND CONTENTS

solution for injection
40 mg/0.4 ml

1 pre-filled pen (SensoReady)

2 pre-filled pens (SensoReady)

4 pre-filled pens (SensoReady)

5. METHOD AND ROUTE(S) OF ADMINISTRATION

Read the package leaflet before use.
Subcutaneous use.
For single use only.

6. SPECIAL WARNING THAT THE MEDICINAL PRODUCT MUST BE STORED OUT OF THE SIGHT AND REACH OF CHILDREN

Keep out of the sight and reach of children.

7. OTHER SPECIAL WARNING, IF NECESSARY

8. EXPIRY DATE

EXP

9. SPECIAL STORAGE CONDITIONS

Store in a refrigerator.

Do not freeze.

Keep the pre-filled pen in the outer carton in order to protect from light.

Keep the pre-filled pens in the outer carton in order to protect from light.

10. SPECIAL PRECAUTIONS FOR DISPOSAL OF UNUSED MEDICINAL PRODUCTS OR WASTE MATERIALS DERIVED FROM SUCH MEDICINAL PRODUCTS, IF APPROPRIATE**11. NAME AND ADDRESS OF THE MARKETING AUTHORISATION HOLDER**

Sandoz GmbH
Biochemiestr. 10
A-6250 Kundl
Austria

12. MARKETING AUTHORISATION NUMBER(S)

EU/1/18/1286/015 1 pre-filled pen

EU/1/18/1286/016 2 pre-filled pens

EU/1/18/1286/017 4 pre-filled pens

13. BATCH NUMBER

Lot

14. GENERAL CLASSIFICATION FOR SUPPLY**15. INSTRUCTIONS ON USE****16. INFORMATION IN BRAILLE**

Hyrimoz 40 mg/0.4 ml

17. UNIQUE IDENTIFIER – 2D BARCODE

2D barcode carrying the unique identifier included.

18. UNIQUE IDENTIFIER – HUMAN READABLE DATA

PC
SN
NN

PARTICULARS TO APPEAR ON THE OUTER PACKAGING

OUTER CARTON OF MULTIPACK (INCLUDING BLUE BOX)

1. NAME OF THE MEDICINAL PRODUCT

Hyrimoz 40 mg solution for injection in pre-filled pen
adalimumab

2. STATEMENT OF ACTIVE SUBSTANCE

One 0.4 ml pre-filled pen contains 40 mg adalimumab.

3. LIST OF EXCIPIENTS

Excipients: adipic acid, mannitol, polysorbate 80, hydrochloric acid, sodium hydroxide, water for injections.

4. PHARMACEUTICAL FORM AND CONTENTS

solution for injection
40 mg/0.4 ml

Multipack: 6 (3 packs of 2) pre-filled pens (SensoReady)

5. METHOD AND ROUTE(S) OF ADMINISTRATION

Read the package leaflet before use.
Subcutaneous use.
For single use only.

6. SPECIAL WARNING THAT THE MEDICINAL PRODUCT MUST BE STORED OUT OF THE SIGHT AND REACH OF CHILDREN

Keep out of the sight and reach of children.

7. OTHER SPECIAL WARNING, IF NECESSARY

8. EXPIRY DATE

EXP

9. SPECIAL STORAGE CONDITIONS

Store in a refrigerator.

Do not freeze.

Keep the pre-filled pens in the outer carton in order to protect from light.

10. SPECIAL PRECAUTIONS FOR DISPOSAL OF UNUSED MEDICINAL PRODUCTS OR WASTE MATERIALS DERIVED FROM SUCH MEDICINAL PRODUCTS, IF APPROPRIATE

11. NAME AND ADDRESS OF THE MARKETING AUTHORISATION HOLDER

Sandoz GmbH
Biochemiestr. 10
A-6250 Kundl
Austria

12. MARKETING AUTHORISATION NUMBER(S)

EU/1/18/1286/018 6 pre-filled pens (3 packs of 2)

13. BATCH NUMBER

Lot

14. GENERAL CLASSIFICATION FOR SUPPLY

15. INSTRUCTIONS ON USE

16. INFORMATION IN BRAILLE

Hyrimoz 40 mg/0.4 ml

17. UNIQUE IDENTIFIER – 2D BARCODE

2D barcode carrying the unique identifier included

18. UNIQUE IDENTIFIER - HUMAN READABLE DATA

PC
SN
NN

PARTICULARS TO APPEAR ON THE OUTER PACKAGING

INNER CARTON OF MULTIPACK (WITHOUT BLUE BOX)

1. NAME OF THE MEDICINAL PRODUCT

Hyrimoz 40 mg solution for injection in pre-filled pen
adalimumab

2. STATEMENT OF ACTIVE SUBSTANCE

One 0.4 ml pre-filled pen contains 40 mg adalimumab.

3. LIST OF EXCIPIENTS

Excipients: adipic acid, mannitol, polysorbate 80, hydrochloric acid, sodium hydroxide, water for injections.

4. PHARMACEUTICAL FORM AND CONTENTS

solution for injection
40 mg/0.4 ml

2 pre-filled pens (SensoReady)

Component of a multipack, cannot be sold separately.

5. METHOD AND ROUTE(S) OF ADMINISTRATION

Read the package leaflet before use.

Subcutaneous use.

For single use only.

6. SPECIAL WARNING THAT THE MEDICINAL PRODUCT MUST BE STORED OUT OF THE SIGHT AND REACH OF CHILDREN

Keep out of the sight and reach of children.

7. OTHER SPECIAL WARNING, IF NECESSARY

8. EXPIRY DATE

EXP

9. SPECIAL STORAGE CONDITIONS

Store in a refrigerator.
Do not freeze.

Keep the pre-filled pens in the outer carton in order to protect from light.

10. SPECIAL PRECAUTIONS FOR DISPOSAL OF UNUSED MEDICINAL PRODUCTS OR WASTE MATERIALS DERIVED FROM SUCH MEDICINAL PRODUCTS, IF APPROPRIATE**11. NAME AND ADDRESS OF THE MARKETING AUTHORISATION HOLDER**

Sandoz GmbH
Biochemiestr. 10
A-6250 Kundl
Austria

12. MARKETING AUTHORISATION NUMBER(S)

EU/1/18/1286/018 6 pre-filled pens (3 packs of 2)

13. BATCH NUMBER

Lot

14. GENERAL CLASSIFICATION FOR SUPPLY**15. INSTRUCTIONS ON USE****16. INFORMATION IN BRAILLE**

Hyrimoz 40 mg/0.4 ml

17. UNIQUE IDENTIFIER – 2D BARCODE**18. UNIQUE IDENTIFIER - HUMAN READABLE DATA**

**MINIMUM PARTICULARS TO APPEAR ON SMALL IMMEDIATE PACKAGING UNITS
PEN LABEL**

1. NAME OF THE MEDICINAL PRODUCT AND ROUTE(S) OF ADMINISTRATION

Hyrimoz 40 mg injection
adalimumab
SC

2. METHOD OF ADMINISTRATION

3. EXPIRY DATE

EXP

4. BATCH NUMBER

Lot

5. CONTENTS BY WEIGHT, BY VOLUME OR BY UNIT

6. OTHER

0.4 ml

PARTICULARS TO APPEAR ON THE OUTER PACKAGING

OUTER CARTON OF UNIT PACK

1. NAME OF THE MEDICINAL PRODUCT

Hyrimoz 80 mg solution for injection in pre-filled syringe
adalimumab

2. STATEMENT OF ACTIVE SUBSTANCE(S)

One 0.8 ml pre-filled syringe contains 80 mg adalimumab.

3. LIST OF EXCIPIENTS

Excipients: adipic acid, mannitol, polysorbate 80, hydrochloric acid, sodium hydroxide, water for injections.

4. PHARMACEUTICAL FORM AND CONTENTS

solution for injection
80 mg/0.8 ml

1 pre-filled syringe
2 pre-filled syringes

5. METHOD AND ROUTE(S) OF ADMINISTRATION

Read the package leaflet before use.
Subcutaneous use.
For single use only.

6. SPECIAL WARNING THAT THE MEDICINAL PRODUCT MUST BE STORED OUT OF THE SIGHT AND REACH OF CHILDREN

Keep out of the sight and reach of children.

7. OTHER SPECIAL WARNING(S), IF NECESSARY

8. EXPIRY DATE

EXP

9. SPECIAL STORAGE CONDITIONS

Store in a refrigerator.

Do not freeze.

Keep the pre-filled syringe in the outer carton in order to protect from light.

Keep the pre-filled syringes in the outer carton in order to protect from light.

10. SPECIAL PRECAUTIONS FOR DISPOSAL OF UNUSED MEDICINAL PRODUCTS OR WASTE MATERIALS DERIVED FROM SUCH MEDICINAL PRODUCTS, IF APPROPRIATE

11. NAME AND ADDRESS OF THE MARKETING AUTHORISATION HOLDER

Sandoz GmbH
Biochemiestr. 10
A-6250 Kundl
Austria

12. MARKETING AUTHORISATION NUMBER(S)

EU/1/18/1286/008 1 pre-filled syringe

EU/1/18/1286/009 2 pre-filled syringes

13. BATCH NUMBER

Lot

14. GENERAL CLASSIFICATION FOR SUPPLY

15. INSTRUCTIONS ON USE

16. INFORMATION IN BRAILLE

Hyrimoz 80 mg/0.8 ml

17. UNIQUE IDENTIFIER – 2D BARCODE

2D barcode carrying the unique identifier included.

18. UNIQUE IDENTIFIER - HUMAN READABLE DATA

PC
SN
NN

MINIMUM PARTICULARS TO APPEAR ON BLISTERS OR STRIPS

BLISTER TEXT

1. NAME OF THE MEDICINAL PRODUCT

Hyrimoz 80 mg injection
adalimumab

2. NAME OF THE MARKETING AUTHORISATION HOLDER

SANDOZ

3. EXPIRY DATE

EXP

4. BATCH NUMBER

Lot

5. OTHER

SC
80 mg/0.8 ml

**MINIMUM PARTICULARS TO APPEAR ON SMALL IMMEDIATE PACKAGING UNITS
SYRINGE LABEL**

1. NAME OF THE MEDICINAL PRODUCT AND ROUTE(S) OF ADMINISTRATION

Hyrimoz 80 mg injection
adalimumab
SC

2. METHOD OF ADMINISTRATION

3. EXPIRY DATE

EXP

4. BATCH NUMBER

Lot

5. CONTENTS BY WEIGHT, BY VOLUME OR BY UNIT

6. OTHER

0.8 ml

PARTICULARS TO APPEAR ON THE OUTER PACKAGING

OUTER CARTON OF UNIT PACK

1. NAME OF THE MEDICINAL PRODUCT

Hyrimoz 80 mg solution for injection in pre-filled pen
adalimumab

2. STATEMENT OF ACTIVE SUBSTANCE

One 0.8 ml pre-filled pen contains 80 mg adalimumab.

3. LIST OF EXCIPIENTS

Excipients: adipic acid, mannitol, polysorbate 80, hydrochloric acid, sodium hydroxide, water for injections.

4. PHARMACEUTICAL FORM AND CONTENTS

solution for injection
80 mg/0.8 ml

1 pre-filled pen (SensoReady)
2 pre-filled pens (SensoReady)
3 pre-filled pens (SensoReady)

5. METHOD AND ROUTE(S) OF ADMINISTRATION

Read the package leaflet before use.
Subcutaneous use.
For single use only.

6. SPECIAL WARNING THAT THE MEDICINAL PRODUCT MUST BE STORED OUT OF THE SIGHT AND REACH OF CHILDREN

Keep out of the sight and reach of children.

7. OTHER SPECIAL WARNING, IF NECESSARY

8. EXPIRY DATE

EXP

9. SPECIAL STORAGE CONDITIONS

Store in a refrigerator.

Do not freeze.

Keep the pre-filled pen in the outer carton in order to protect from light.

Keep the pre-filled pens in the outer carton in order to protect from light.

10. SPECIAL PRECAUTIONS FOR DISPOSAL OF UNUSED MEDICINAL PRODUCTS OR WASTE MATERIALS DERIVED FROM SUCH MEDICINAL PRODUCTS, IF APPROPRIATE**11. NAME AND ADDRESS OF THE MARKETING AUTHORISATION HOLDER**

Sandoz GmbH
Biochemiestr. 10
A-6250 Kundl
Austria

12. MARKETING AUTHORISATION NUMBER(S)

EU/1/18/1286/010 1 pre-filled pen

EU/1/18/1286/011 2 pre-filled pens

EU/1/18/1286/020 3 pre-filled pens

13. BATCH NUMBER

Lot

14. GENERAL CLASSIFICATION FOR SUPPLY**15. INSTRUCTIONS ON USE****16. INFORMATION IN BRAILLE**

Hyrimoz 80 mg/0.8 ml

17. UNIQUE IDENTIFIER – 2D BARCODE

2D barcode carrying the unique identifier included.

18. UNIQUE IDENTIFIER – HUMAN READABLE DATA

PC
SN
NN

**MINIMUM PARTICULARS TO APPEAR ON SMALL IMMEDIATE PACKAGING UNITS
PEN LABEL**

1. NAME OF THE MEDICINAL PRODUCT AND ROUTE(S) OF ADMINISTRATION

Hyrimoz 80 mg injection
adalimumab
SC

2. METHOD OF ADMINISTRATION

3. EXPIRY DATE

EXP

4. BATCH NUMBER

Lot

5. CONTENTS BY WEIGHT, BY VOLUME OR BY UNIT

6. OTHER

0.8 ml

B. PACKAGE LEAFLET

Package leaflet: Information for the patient

Hyrimoz 20 mg solution for injection in pre-filled syringe adalimumab 20 mg/0.4 ml

Read all of this leaflet carefully before your child starts using this medicine because it contains important information.

- Keep this leaflet. You may need to read it again.
- Your doctor will also give you a **Patient Reminder Card**, which contains important safety information that you need to be aware of before your child begins using Hyrimoz and during treatment with Hyrimoz. Keep this **Patient Reminder Card** with you or your child during your treatment and for 4 months after your child's last injection of Hyrimoz.
- If you have any further questions, please ask your doctor or pharmacist.
- This medicine has been prescribed for your child only. Do not pass it on to others. It may harm them, even if their signs of illness are the same as your child's.
- If your child gets any side effects, talk to your doctor or pharmacist. This includes any possible side effects not listed in this leaflet. See section 4.

What is in this leaflet

1. What Hyrimoz is and what it is used for
2. What you need to know before your child uses Hyrimoz
3. How to use Hyrimoz
4. Possible side effects
5. How to store Hyrimoz
6. Contents of the pack and other information
7. Instructions for use

1. What Hyrimoz is and what it is used for

Hyrimoz contains the active substance adalimumab, a medicine that acts on your body's immune (defence) system.

Hyrimoz is intended for the treatment of the following inflammatory diseases:

- polyarticular juvenile idiopathic arthritis,
- enthesitis-related arthritis
- paediatric plaque psoriasis,
- paediatric Crohn's disease,
- paediatric non-infectious uveitis.

The active substance in Hyrimoz, adalimumab, is a monoclonal antibody. Monoclonal antibodies are proteins that attach to a specific target in the body.

The target of adalimumab is another protein called tumour necrosis factor (TNF α), which is present at increased levels in the inflammatory diseases listed above. By attaching to TNF α , Hyrimoz blocks its action and reduces the inflammation in these diseases.

Polyarticular juvenile idiopathic arthritis and enthesitis-related arthritis

Polyarticular juvenile idiopathic arthritis and enthesitis-related arthritis are inflammatory diseases of the joints that usually first appear in childhood.

Hyrimoz is used to treat polyarticular juvenile idiopathic arthritis in children and adolescents aged 2 to 17 years and enthesitis-related arthritis in children and adolescents aged 6 to 17 years. Patients may first be given other disease-modifying medicines, such as methotrexate. If these medicines do not

work well enough, patients will be given Hyrimoz to treat their polyarticular juvenile idiopathic arthritis or enthesitis-related arthritis.

Paediatric plaque psoriasis

Plaque psoriasis is an inflammatory skin condition that causes red, flaky, crusty patches of skin covered with silvery scales. Plaque psoriasis can also affect the nails, causing them to crumble, become thickened and lift away from the nail bed which can be painful. Psoriasis is believed to be caused by a problem with the body's immune system that leads to an increased production of skin cells.

Hyrimoz is also used to treat severe plaque psoriasis in children and adolescents aged 4 to 17 years for whom medicines applied to the skin and treatment with UV light have either not worked very well or are not suitable.

Paediatric Crohn's disease

Crohn's disease is an inflammatory disease of the gut.

Hyrimoz is used to treat moderate to severe Crohn's disease in children and adolescents aged 6 to 17 years.

Your child may first be given other medicines. If these medicines do not work well enough, your child will be given Hyrimoz to reduce the signs and symptoms of his/her disease.

Paediatric non-infectious uveitis

Non-infectious uveitis is an inflammatory disease affecting certain parts of the eye. The inflammation leads to a decrease of vision and/or the presence of floaters in the eye (black dots or wispy lines that move across the field of vision). Hyrimoz works by reducing this inflammation.

Hyrimoz is used to treat children from 2 years of age with chronic non-infectious uveitis with inflammation affecting the front of the eye.

Your child may first be given other medicines. If these medicines do not work well enough, your child will be given Hyrimoz to reduce the signs and symptoms of his/her disease.

2. What you need to know before your child uses Hyrimoz

Do not use Hyrimoz

- if your child is allergic to adalimumab or any of the other ingredients of this medicine (listed in section 6).
- if your child has a severe infection, including tuberculosis, sepsis (blood poisoning) or other opportunistic infections (unusual infections associated with a weakened immune system). It is important that you tell your doctor if your child shows symptoms of infections, e.g. fever, wounds, feeling tired, dental problems (see "Warnings and precautions").
- if your child has moderate or severe heart failure. It is important to tell your doctor if your child has had or has a serious heart condition (see "Warnings and precautions").

Warnings and precautions

Talk to your doctor or pharmacist before using Hyrimoz.

Allergic reaction

- If your child has allergic reactions with symptoms such as chest tightness, wheezing, dizziness, swelling or rash, do not inject more Hyrimoz and contact your doctor immediately, since in rare cases, these reactions can be life-threatening.

Infection

- If your child has an infection, including long-term or localised infection (for example leg ulcer), consult your doctor before starting Hyrimoz. If you are unsure, contact your doctor.
- Your child might get infections more easily while he/she is receiving Hyrimoz treatment. This risk may increase if your child's lung function is reduced. These infections may be more serious and include tuberculosis, infections caused by viruses, fungi, parasites or bacteria, or other unusual infectious organisms and sepsis (blood poisoning).
- In rare cases, these infections may be life-threatening. It is important to tell your doctor if your child shows symptoms such as fever, wounds, feeling tired or dental problems. Your doctor may recommend temporarily stopping Hyrimoz.

Tuberculosis (TB)

- As cases of tuberculosis have been reported in patients treated with adalimumab, your doctor will check your child for signs and symptoms of tuberculosis before starting Hyrimoz. This will include a thorough medical evaluation including your child's medical history and screening tests (for example chest X-ray and a tuberculin test). The conduct and results of these tests should be recorded on your child's Patient Reminder Card. It is very important that you tell your doctor if your child has ever had tuberculosis, or if he/she has been in close contact with someone who has had tuberculosis. Tuberculosis can develop during therapy even if your child has had preventative treatment for tuberculosis. If symptoms of tuberculosis (persistent cough, weight loss, listlessness, mild fever), or any other infection appear during or after therapy tell your doctor immediately.

Travel/recurrent infection

- Tell your doctor if your child has lived or travelled in regions where fungal infections such as histoplasmosis, coccidioidomycosis or blastomycosis are common.
- Tell your doctor if your child has a history of recurrent infections or other conditions that increase the risk of infections.

Hepatitis B virus

- Tell your doctor if your child is a carrier of the hepatitis B virus (HBV), if he/she has active HBV infection or if you think he/she might be at risk of contracting HBV. Your doctor should test your child for HBV. Adalimumab can reactivate HBV infection in people who carry this virus. In some rare cases, especially if your child is taking other medicines that suppress the immune system, reactivation of HBV infection can be life-threatening.

Surgery or dental procedures

- If your child is about to have surgery or dental procedures tell your doctor that your child is taking Hyrimoz. Your doctor may recommend temporarily stopping Hyrimoz.

Demyelinating disease

- If your child has or develops demyelinating disease (a disease that affects the insulating layer around the nerves, such as multiple sclerosis), your doctor will decide if he/she should receive or continue to receive Hyrimoz. Tell your doctor immediately if he/she experiences symptoms like changes in vision, weakness in arms or legs or numbness or tingling in any part of the body.

Vaccine

- Certain vaccines contain living but weakened forms of disease-causing bacteria or viruses and should not be given during treatment with Hyrimoz in case they cause infections. Check with your doctor before your child receives any vaccines. It is recommended that, if possible, children be given all the scheduled vaccinations for their age before they start treatment with Hyrimoz.

If your child receives Hyrimoz while she is pregnant, her baby may be at higher risk for getting an infection for up to about five months after the last dose she received during pregnancy. It is important that you tell her baby's doctors and other health care professionals about your child's Hyrimoz use during her pregnancy so they can decide when her baby should receive any vaccine.

Heart failure

- It is important to tell your doctor if your child has had or has a serious heart condition. If your child has mild heart failure and is being treated with Hyrimoz, the heart failure status must be closely monitored by your doctor. If your child develops new or worsening symptoms of heart failure (e.g. shortness of breath, or swelling of your feet), you must contact your doctor immediately.

Fever, bruising, bleeding or looking pale

- In some patients the body may fail to produce enough of the blood cells that fight off infections or help stop bleeding. If your child develops a fever that does not go away, or he/she bruises or bleeds very easily or looks very pale, call your doctor right away. Your doctor may decide to stop treatment.

Cancer

- There have been very rare cases of certain kinds of cancer in children and adults taking adalimumab or other TNF α blockers. People with more serious rheumatoid arthritis who have had the disease for a long time may have a higher than average risk of getting lymphoma and leukaemia (cancers that affect blood cells and bone marrow). If your child takes Hyrimoz, the risk of getting lymphoma, leukaemia, or other cancers may increase. On rare occasions, a specific and severe type of lymphoma has been observed in patients taking adalimumab. Some of those patients were also treated with the medicines azathioprine or mercaptopurine. Tell your doctor if your child is taking azathioprine or mercaptopurine with Hyrimoz.
- In addition cases of non-melanoma skin cancer have been observed in patients taking adalimumab. If new areas of damaged skin appear during or after treatment or if existing marks or areas of damage change appearance, tell your doctor.
- There have been cases of cancers, other than lymphoma, in patients with a specific type of lung disease called chronic obstructive pulmonary disease (COPD) treated with another TNF α blocker. If your child has COPD, or is a heavy smoker, you should discuss with your doctor whether treatment with a TNF α blocker is appropriate.

Autoimmune diseases

- On rare occasions, treatment with Hyrimoz could result in lupus-like syndrome. Contact your doctor, if symptoms such as persistent unexplained rash, fever, joint pain or tiredness occur.

Other medicines and Hyrimoz

Tell your doctor or pharmacist if your child is taking, has recently taken or might take any other medicines.

Hyrimoz can be taken together with methotrexate or certain disease-modifying anti-rheumatic agents (sulfasalazine, hydroxychloroquine, leflunomide and injectable gold preparations), corticosteroids or pain medications including non-steroidal anti-inflammatory drugs (NSAIDs).

Your child should not take Hyrimoz with medicines containing the active substances anakinra or abatacept due to increased risk of serious infection. The combination of adalimumab as well as other TNF-antagonists and anakinra or abatacept is not recommended based upon the possible increased risk for infections, including serious infections and other potential pharmacological interactions. If you have questions, please ask your doctor.

Pregnancy and breast-feeding

- Your child should consider the use of adequate contraception to prevent pregnancy and continue its use for at least 5 months after the last Hyrimoz treatment.
- If your child is pregnant, thinks she may be pregnant or is planning to have a baby, ask her doctor for advice before taking this medicine.
- Hyrimoz should only be used during a pregnancy if needed.
- According to a pregnancy study, there was no higher risk of birth defects when the mother had received adalimumab during pregnancy compared with mothers with the same disease who did not receive adalimumab.
- Hyrimoz can be used during breast-feeding.
- If your child receives Hyrimoz during her pregnancy, the baby may have a higher risk for getting an infection.
- It is important that you tell her baby's doctors and other health care professionals about her Hyrimoz use during her pregnancy before the baby receives any vaccine (for more information on vaccines see the "Warnings and precautions" section).

Driving and using machines

Hyrimoz may have a minor influence on the ability to drive, cycle or use machines. Room spinning sensation (vertigo) and vision disturbances may occur after taking Hyrimoz.

Hyrimoz contains sodium

This medicine contains less than 1 mmol of sodium (23 mg) per 0.4 ml dose, that is to say essentially 'sodium-free'.

3. How to use Hyrimoz

Always use this medicine exactly as your doctor or pharmacist has told you. Check with your doctor or pharmacist if you are not sure.

Hyrimoz is available as a 40 mg pen as well as 20 mg and 40 mg pre-filled syringes for patients to

administer a full 20 mg or 40 mg dose.

Polyarticular juvenile idiopathic arthritis		
Age and body weight	How much and how often to take?	Notes
Children, adolescents and adults from 2 years of age weighing 30 kg or more	40 mg every other week	Not applicable
Children, adolescents from 2 years of age weighing 10 kg to less than 30 kg	20 mg every other week	Not applicable

Enthesitis-related arthritis		
Age and body weight	How much and how often to take?	Notes
Children, adolescents and adults from 6 years of age weighing 30 kg or more	40 mg every other week	Not applicable
Children, adolescents from 6 years of age weighing 15 kg to less than 30 kg	20 mg every other week	Not applicable

Paediatric plaque psoriasis		
Age and body weight	How much and how often to take?	Notes
Children and adolescents from 4 to 17 years of age weighing 30 kg or more	First dose of 40 mg, followed by 40 mg one week later. Thereafter, the usual dose is 40 mg every other week.	Not applicable
Children and adolescents from 4 to 17 years of age weighing 15 kg to less than 30 kg	First dose of 20 mg, followed by 20 mg one week later. Thereafter, the usual dose is 20 mg every other week.	Not applicable

Paediatric Crohn's disease		
Age and body weight	How much and how often to take?	Notes
Children and adolescent from 6 to 17 years of age weighing 40 kg or more	<p>First dose of 80 mg (as two 40 mg injections in one day), followed by 40 mg every other week starting two weeks later.</p> <p>If a faster response is required your doctor may prescribe a first dose of 160 mg (as four 40 mg injections in one day or two 40 mg injections per day for two consecutive days), followed by 80 mg (as two 40 mg injections in one day) two weeks later.</p> <p>Thereafter the usual dose is 40 mg every other week.</p>	If this dose does not work well enough, your child's doctor may increase the dose to 40 mg every week or 80 mg every other week.
Children and adolescents from 6 to 17 years of age weighing less than 40 kg	<p>First dose of 40 mg, followed by 20 mg every other week starting two weeks later.</p> <p>If a faster response is required, your doctor may prescribe a first dose of 80 mg (as two 40 mg injections in one day), followed by 40 mg two weeks later.</p> <p>Thereafter the usual dose is 20 mg every other week.</p>	If this dose does not work well enough, your child's doctor may increase the dose frequency to 20 mg every week.

Paediatric non-infectious uveitis		
Age and body weight	How much and how often to take?	Notes
Children and adolescents from 2 years of age weighing 30 kg or more	40 mg every other week with methotrexate	Your doctor may also prescribe a first dose of 80 mg which may be administered one week prior to the start of the usual dose.
Children and adolescents from 2 years of age weighing less than 30 kg	20 mg every other week with methotrexate	Your doctor may also prescribe a first dose of 40 mg which may be administered one week prior to the start of the usual dose.

Method and route of administration

Hyrimoz is administered by injection under the skin (by subcutaneous injection).

Detailed instructions on how to inject Hyrimoz are provided in section 7, **“Instructions for use”**.

If you use more Hyrimoz than you should

If you accidentally inject Hyrimoz more frequently than you should, call your doctor or pharmacist

and explain that your child has received more medication than required. Always take the outer carton of medicine with you, even if it is empty.

If you forget to use Hyrimoz

If you forget to give your child an injection, you should inject the next dose of Hyrimoz as soon as you remember. Then take your child's next dose as you would have on the originally scheduled day, had you not forgotten a dose.

If you stop using Hyrimoz

The decision to stop using Hyrimoz should be discussed with your child's doctor. The symptoms may return upon stopping treatment.

If you have any further questions on the use of this medicine, ask your doctor or pharmacist.

4. Possible side effects

Like all medicines, this medicine can cause side effects, although not everybody gets them. Most side effects are mild to moderate. However, some may be serious and require treatment. Side effects may occur up to 4 months or more after the last Hyrimoz injection.

Seek medical attention urgently, if you notice any of the following signs of allergic reaction or heart failure:

- severe rash, hives;
- swollen face, hands, feet;
- trouble breathing, swallowing;
- shortness of breath with exertion or upon lying down or swelling of the feet.

Tell your doctor as soon as possible, if you notice any of the following:

- signs and symptoms of infection such as fever, feeling sick, wounds, dental problems, burning on urination, feeling weak or tired or coughing;
- symptoms of nerve problems such as tingling, numbness, double vision or arm or leg weakness;
- signs of skin cancer such as a bump or open sore that doesn't heal;
- signs and symptoms suggestive of blood disorders such as persistent fever, bruising, bleeding, paleness.

The following side effects have been observed with adalimumab:

Very common (may affect more than 1 in 10 people)

- injection site reactions (including pain, swelling, redness or itching);
- respiratory tract infections (including cold, runny nose, sinus infection, pneumonia);
- headache;
- abdominal (belly) pain;
- nausea and vomiting;
- rash;
- pain in the muscles.

Common (may affect up to 1 in 10 people)

- serious infections (including blood poisoning and influenza);
- intestinal infections (including gastroenteritis);
- skin infections (including cellulitis and shingles);
- ear infections;

- mouth infections (including tooth infections and cold sores);
- reproductive tract infections;
- urinary tract infection;
- fungal infections;
- joint infections;
- benign tumours;
- skin cancer;
- allergic reactions (including seasonal allergy);
- dehydration;
- mood swings (including depression);
- anxiety;
- difficulty sleeping;
- sensation disorders such as tingling, prickling or numbness;
- migraine;
- symptoms of nerve root compression (including low back pain and leg pain);
- vision disturbances;
- eye inflammation;
- inflammation of the eye lid and eye swelling;
- vertigo (sensation of room spinning);
- sensation of heart beating rapidly;
- high blood pressure;
- flushing;
- haematoma (a solid swelling with clotted blood);
- cough;
- asthma;
- shortness of breath;
- gastrointestinal bleeding;
- dyspepsia (indigestion, bloating, heart burn);
- acid reflux disease;
- sicca syndrome (including dry eyes and dry mouth);
- itching;
- itchy rash;
- bruising;
- inflammation of the skin (such as eczema);
- breaking of finger nails and toe nails;
- increased sweating;
- hair loss;
- new onset or worsening of psoriasis;
- muscle spasms;
- blood in urine;
- kidney problems;
- chest pain;
- oedema (a build-up of fluid in the body which causes the affected tissue to swell);
- fever;
- reduction in blood platelets which increases risk of bleeding or bruising;
- impaired healing.

Uncommon (may affect up to 1 in 100 people)

- unusual infections (which include tuberculosis and other infections) that occur when resistance to disease is lowered;
- neurological infections (including viral meningitis);
- eye infections;
- bacterial infections;

- diverticulitis (inflammation and infection of the large intestine);
- cancer, including cancer that affects the lymph system (lymphoma) and melanoma (a type of skin cancer);
- immune disorders that could affect the lungs, skin and lymph nodes (most commonly as a condition called sarcoidosis);
- vasculitis (inflammation of blood vessels);
- tremor;
- neuropathy (nerve damage);
- stroke;
- double vision;
- hearing loss, buzzing;
- sensation of heart beating irregularly such as skipped beats;
- heart problems that can cause shortness of breath or ankle swelling;
- heart attack;
- a sac in the wall of a major artery, inflammation and clot of a vein; blockage of a blood vessel;
- lung diseases causing shortness of breath (including inflammation);
- pulmonary embolism (blockage in an artery of the lung);
- pleural effusion (abnormal collection of fluid in the pleural space);
- inflammation of the pancreas which causes severe pain in the abdomen and back;
- difficulty in swallowing;
- facial oedema (swelling);
- gallbladder inflammation, gallbladder stones;
- fatty liver (build-up of fat in liver cells);
- night sweats;
- scar;
- abnormal muscle breakdown;
- systemic lupus erythematosus (an immune disorder including inflammation of skin, heart, lung, joints and other organ systems);
- sleep interruptions;
- impotence;
- inflammations.

Rare (may affect up to 1 in 1 000 people)

- leukaemia (cancer affecting the blood and bone marrow);
- severe allergic reaction with shock;
- multiple sclerosis;
- nerve disorders (such as inflammation of the optic nerve to the eye, and Guillain-Barré syndrome, a condition that may cause muscle weakness, abnormal sensations, tingling in the arms and upper body);
- heart stops pumping;
- pulmonary fibrosis (scarring of the lung);
- intestinal perforation (hole in the wall of the gut);
- hepatitis (liver inflammation);
- reactivation of hepatitis B infection;
- autoimmune hepatitis (inflammation of the liver caused by the body's own immune system);
- cutaneous vasculitis (inflammation of blood vessels in the skin);
- Stevens-Johnson syndrome (life-threatening reaction with flu-like symptoms and blistering rash);
- facial oedema (swelling) associated with allergic reactions;
- erythema multiforme (inflammatory skin rash);
- lupus-like syndrome;
- angioedema (localised swelling of the skin);
- lichenoid skin reaction (itchy reddish-purple skin rash).

Not known (frequency cannot be estimated from available data)

- hepatosplenic T-cell lymphoma (a rare blood cancer that is often fatal);
- Merkel cell carcinoma (a type of skin cancer);
- Kaposi's sarcoma, a rare cancer related to infection with human herpes virus 8. Kaposi's sarcoma most commonly appears as purple lesions on the skin;
- liver failure;
- worsening of a condition called dermatomyositis (seen as a skin rash accompanying muscle weakness).
- weight gain (for most patients, the weight gain was small)

Some side effects observed with adalimumab may not have symptoms and may only be discovered through blood tests. These include:

Very common (may affect more than 1 in 10 people)

- low blood measurements for white blood cells;
- low blood measurements for red blood cells;
- increased lipids in the blood;
- raised liver enzymes.

Common (may affect up to 1 in 10 people)

- high blood measurements for white blood cells;
- low blood measurements for platelets;
- increased uric acid in the blood;
- abnormal blood measurements for sodium;
- low blood measurements for calcium;
- low blood measurements for phosphate;
- high blood sugar;
- high blood measurements for lactate dehydrogenase;
- autoantibodies present in the blood;
- low blood potassium.

Uncommon (may affect up to 1 in 100 people)

- raised bilirubin measurement (liver blood test).

Rare (may affect up to 1 in 1 000 people)

- low blood measurements for white blood cells, red blood cells and platelet count.

Reporting of side effects

If your child gets any side effects, talk to your doctor or pharmacist. This includes any possible side effects not listed in this leaflet. You can also report side effects directly via the national reporting system listed in [Appendix V](#). By reporting side effects, you can help provide more information on the safety of this medicine.

5. How to store Hyrimoz

Keep this medicine out of the sight and reach of children.

Do not use this medicine after the expiry date which is stated on the label/blister/carton after EXP.

The expiry date refers to the last day of that month.

Store in a refrigerator (2°C–8°C). Do not freeze.

Keep the pre-filled syringe in the outer carton in order to protect from light.

Alternative Storage:

When needed (for example when you are travelling), Hyrimoz may be stored at room temperature (up to 25°C) for a maximum period of 21 days – be sure to protect it from light. Once removed from the refrigerator for room temperature storage, your pre-filled syringe **must be used within 21 days or discarded**, even if it is later returned to the refrigerator. You should record the date when your pre-filled syringe is first removed from the refrigerator, and the date after which it should be discarded.

Do not throw away any medicines via wastewater or household waste. Ask your pharmacist how to throw away medicines you no longer use. These measures will help protect the environment.

6. Contents of the pack and other information

What Hyrimoz contains

- The active substance is adalimumab. Each pre-filled syringe contains 20 mg of adalimumab in 0.4 ml of solution.
- The other ingredients are adipic acid, citric acid monohydrate, sodium chloride, mannitol (E 421), polysorbate 80 (E 433), hydrochloric acid (E 507), sodium hydroxide (E 524) and water for injections (see section 2 “Hyrimoz contains sodium”).

What Hyrimoz looks like and contents of the pack

Hyrimoz 20 mg solution for injection (injection) in pre-filled syringe for paediatric use is supplied as a 0.4 ml clear to slightly opalescent, colourless or slightly yellowish solution.

Hyrimoz is supplied in a single-use clear type I glass syringe with a stainless steel 29 gauge needle with a needle guard with finger flange, rubber needle cap (thermoplastic elastomer) and plastic plunger rod, containing 0.4 ml of solution.

Carton contains 2 pre-filled syringes of Hyrimoz.

Not all pack sizes may be marketed.

Hyrimoz is available as a pre-filled syringe and a pre-filled pen.

Marketing Authorisation Holder

Sandoz GmbH
Biochemiestr. 10
6250 Kundl
Austria

Manufacturer

Sandoz GmbH Schafteuau
Biochemiestr. 10
6336 Langkampfen
Austria

Novartis Pharmaceutical Manufacturing GmbH
Biochemiestrasse 10
6336 Langkampfen
Austria

For any information about this medicine, please contact the local representative of the Marketing Authorisation Holder:

België/Belgique/Belgien

Sandoz nv/sa
Tél/Tel.: +32 2 722 97 97

Lietuva

Sandoz Pharmaceuticals d.d filialas
Tel.: +370 5 2636 037

България

Сандоз България КЧТ
Тел.: +359 2 970 47 47

Luxembourg/Luxemburg

Sandoz nv/sa (Belgique/Belgien)
Tél/Tel.: +32 2 722 97 97

Česká republika

Sandoz s.r.o.
Tel: +420 225 775 111

Magyarország

Sandoz Hungária Kft.
Tel.: +36 1 430 2890

Danmark/Norge/Ísland/Sverige

Sandoz A/S
Tlf./Sími/Tel: +45 63 95 10 00

Malta

Sandoz Pharmaceuticals d.d.
Tel: +356 99644126

Deutschland

Hexal AG
Tel: +49 8024 908 0

Nederland

Sandoz B.V.
Tel: +31 36 52 41 600

Eesti

Sandoz d.d. Eesti filiaal
Tel: +372 665 2400

Österreich

Sandoz GmbH
Tel: +43 5338 2000

Ελλάδα

SANDOZ HELLAS ΜΟΝΟΠΡΟΣΩΠΗ Α.Ε.
Τηλ: +30 216 600 5000

Polska

Sandoz Polska Sp. z o.o.
Tel.: +48 22 209 70 00

España

Sandoz Farmacéutica, S.A.
Tel: +34 900 456 856

Portugal

Sandoz Farmacêutica Lda.
Tel: +351 21 000 86 00

France

Sandoz SAS
Tél: +33 1 49 64 48 00

România

Sandoz Pharmaceuticals SRL
Tel: +40 21 407 51 60

Hrvatska

Sandoz d.o.o.
Tel: +385 1 23 53 111

Slovenija

Sandoz farmacevtska družba d.d.
Tel: +386 1 580 29 02

Ireland
Rowex Ltd.
Tel: +353 27 50077

Slovenská republika
Sandoz d.d. - organizačná zložka
Tel: +421 2 48 200 600

Italia
Sandoz S.p.A.
Tel: +39 02 96541

Suomi/Finland
Sandoz A/S
Puh/Tel: +358 10 6133 400

Κύπρος
SANDOZ HELLAS MONOΠΡΟΣΩΠΗ Α.Ε.
(Ελλάδα)
Τηλ: +30 216 600 5000

United Kingdom (Northern Ireland)
Sandoz GmbH
Tel: +43 5338 2000

Latvija
Sandoz d.d. Latvia filiāle
Tel: +371 67 892 006

This leaflet was last revised in

Other sources of information

Detailed information on this medicine is available on the European Medicines Agency web site:
<https://www.ema.europa.eu>.

7. Instructions for use

To help avoid possible infections and to ensure that you use the medicine correctly, it is important that you follow these instructions.

Be sure that you read, understand, and follow these Instructions for Use before injecting Hyrimoz. Your healthcare provider should show you how to prepare and inject Hyrimoz properly using the pre-filled syringe before you use it for the first time. Talk to your healthcare provider if you have any questions.

Your Hyrimoz single-use pre-filled syringe with needle guard and add-on finger flange

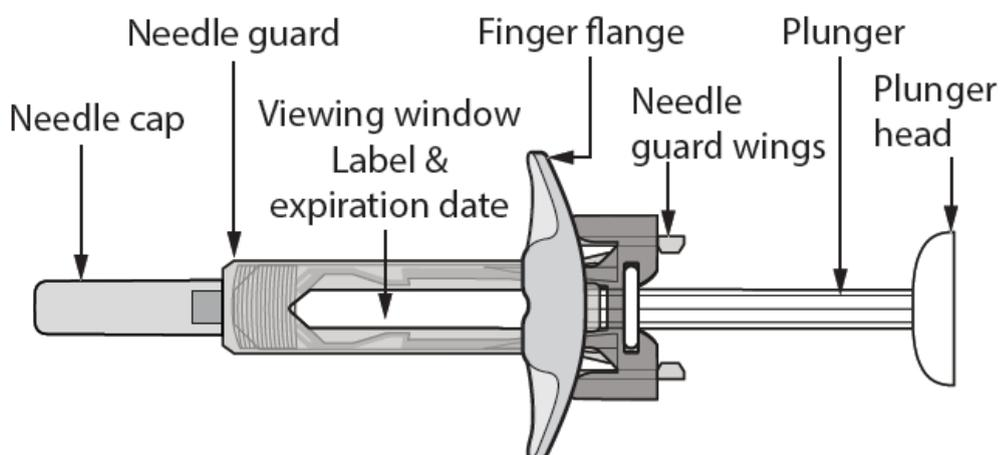

Figure A: Hyrimoz pre-filled syringe with needle guard and add-on finger flange

It is important that you:

- **do not open** the outer box until you are ready to use the syringe.
- **do not use** the syringe if the seals of the blister are broken, as it may not be safe for you to use.
- **never leave** the syringe unattended where others might tamper with it.
- if you drop your syringe, **do not use** it if it looks damaged, or if you dropped it with the needle cap removed.
- **do not remove** the needle cap until just before you give the injection.
- be careful **not to touch** the needle guard wings before use. Touching them may cause the needle guard to be activated too early. **Do not remove** the finger flange before the injection.
- inject Hyrimoz 15–30 minutes after taking it out of the refrigerator for a more comfortable injection.
- throw away the used syringe right away after use. **Do not re-use a syringe.** See “4. Disposing of used syringes” at the end of these Instructions for Use.

How should you store Hyrimoz?

- Store your outer carton of syringes in a refrigerator, between 2°C to 8°C.
- When needed (for example when you are travelling), Hyrimoz may be stored at room temperature (up to 25°C) for a maximum period of 21 days – be sure to protect it from light. Once removed from the refrigerator for room temperature storage, your pre-filled syringe **must be used within 21 days or discarded**, even if it is later returned to the refrigerator. You should record the date when your pre-filled syringe is first removed from the refrigerator, and the date after which it should be discarded.
- Keep the syringes in the original carton until ready to use to protect from light.
- Do not store the syringes in extreme heat or cold.
- Do not freeze the syringes.

Keep Hyrimoz and all medicines out of the reach of children.

What do you need for your injection?

Place the following items on a clean, flat surface.

Included in your carton is:

- Hyrimoz pre-filled syringe/s (see *Figure A*). Each syringe contains 20 mg/0.4 ml of Hyrimoz.

Not included in your carton are (see *Figure B*):

- Alcohol wipe
- Cotton ball or gauze
- Sharps disposal container

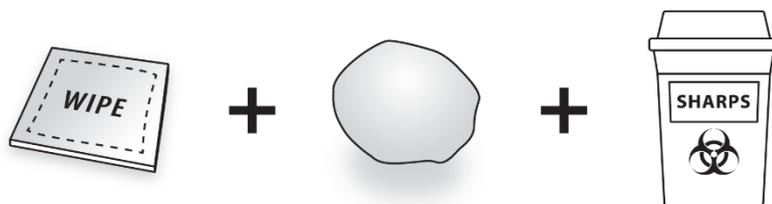

Figure B: items not included in the carton

See “4. **Disposing of used syringes**” at the end of these Instructions for Use.

Before your injection

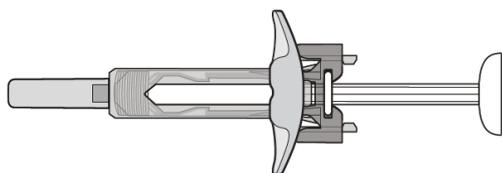

Figure C: needle guard is not activated – the syringe is ready for use

- In this configuration the needle guard is **NOT ACTIVATED**.
- The syringe is ready for use (see Figure C).

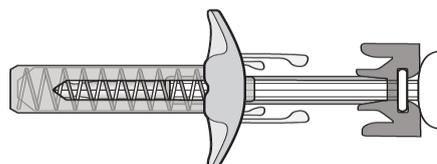

Figure D: needle guard is activated – do not use

- In this configuration the needle guard is **ACTIVATED**.
- **DO NOT USE** the syringe (see Figure D).

Preparing the syringe

- For a more comfortable injection, take the blister containing the syringe out of the refrigerator and leave it unopened on your work surface for about 15 to 30 minutes so that it reaches room temperature.
- Take the syringe out of the blister.
- Look through the viewing window. The solution should be colourless or slightly yellowish as well as clear to slightly opalescent. Do not use if any particulates and/or discolorations are observed. If you are concerned with the appearance of the solution, then contact your pharmacist for assistance.
- Do not use the syringe if it is broken or the needle guard is activated. Return the syringe and the package it came in to the pharmacy.
- Look at the expiry date (EXP) on your syringe. Do not use the syringe if the expiry date has passed.

Contact your pharmacist if the syringe fails any of the above mentioned checks.

1. Choosing your injection site:

- The recommended injection site is the front of your thighs. You may also use the lower abdomen, but not the area 5 cm around your navel (belly button) (see Figure E).
- Choose a different site each time you give yourself an injection.
- Do not inject into areas where the skin is tender, bruised, red, scaly, or hard. Avoid areas with scars or stretch marks. If you have psoriasis, you should NOT inject directly into areas with psoriasis plaques.

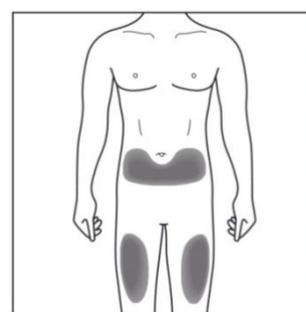

Figure E: choose your injection site

2. Cleaning your injection site:

- Wash your hands well with soap and water.
- Using a circular motion, clean the injection site with an alcohol wipe. Leave it to dry before injecting (*see Figure F*).
- Do not touch the cleaned area before injecting.



Figure F: clean your injection site

3. Giving your injection:

- Carefully pull the needle cap straight off to remove it from the syringe (*see Figure G*).
- Discard the needle cap.
- You may see a drop of liquid at the end of the needle. This is normal.

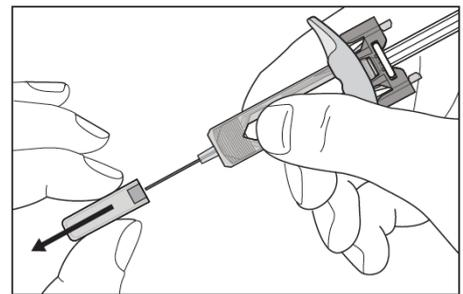

Figure G: pull the needle cap off

- Gently pinch the skin at the injection site (*see Figure H*).
- Insert the needle into your skin as shown.
- Push the needle all the way in to ensure that the medication can be fully administered.

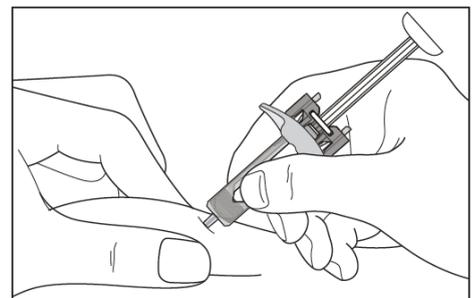

Figure H: insert the needle

- Hold the syringe as shown (see *Figure I*).
- Slowly press down on the plunger as far as it will go, so that the plunger head is completely between the needle guard wings.
- Keep the plunger pressed fully down while you hold the syringe in place for 5 seconds.

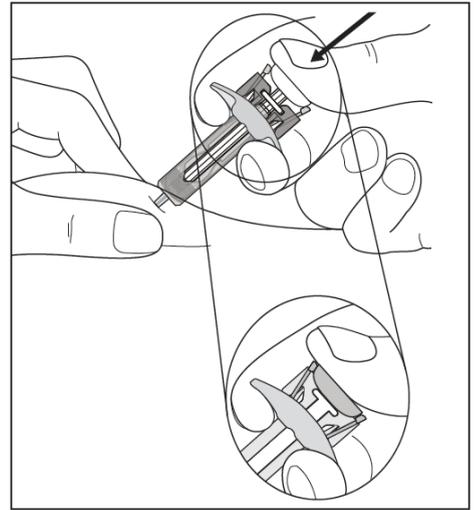

Figure I: hold the syringe

- **Keep the plunger fully pressed down** while you carefully lift the needle straight out from the injection site and let go of your skin (see *Figure J*).

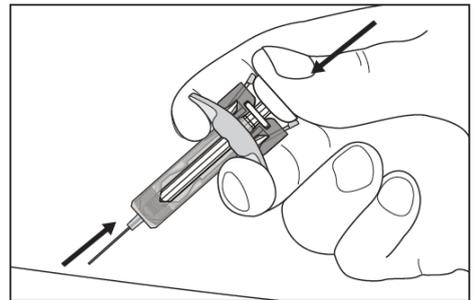

Figure J: lift the needle straight out

- Slowly release the plunger and allow the needle safety guard to automatically cover the exposed needle (see *Figure K*).
- There may be a small amount of blood at the injection site. You can press a cotton ball or gauze onto the injection site and hold it for 10 seconds. Do not rub the injection site. You may cover the injection site with a small adhesive bandage, if needed.

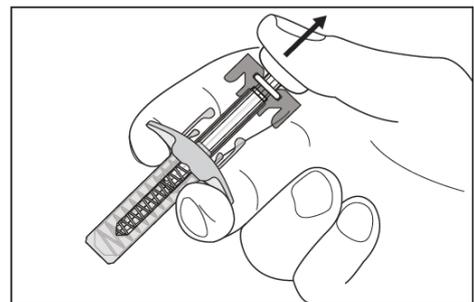
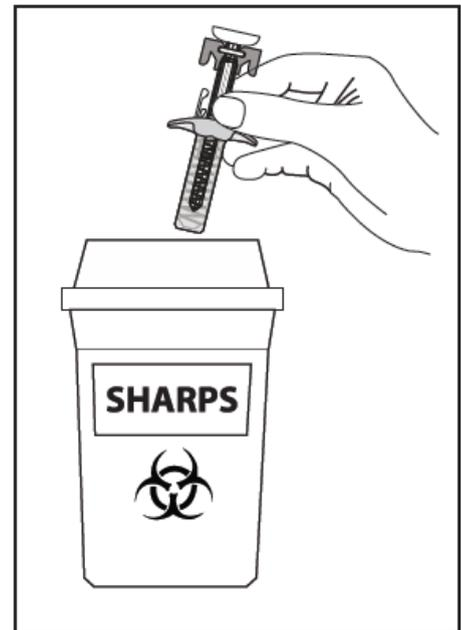

Figure K: slowly release the plunger

4. Disposing of used syringes:

- Dispose of the used syringe in a sharps container (closable, puncture-resistant container). For the safety and health of you and others, needles and used syringes must never be re-used.
- Do not throw away any medicines via wastewater or household waste. Ask your doctor or pharmacist how to throw away medicines you no longer use. These measures will help protect the environment. Any unused product or waste material should be disposed of in accordance with local requirements.



If you have any questions, please talk to a doctor, pharmacist or nurse who is familiar with Hyrimoz.

Package leaflet: Information for the patient

Hyrimoz 20 mg solution for injection in pre-filled syringe adalimumab 20 mg/0.2 ml

Read all of this leaflet carefully before your child starts using this medicine because it contains important information.

- Keep this leaflet. You may need to read it again.
- Your doctor will also give you a **Patient Reminder Card**, which contains important safety information that you need to be aware of before your child begins using Hyrimoz and during treatment with Hyrimoz. Keep this **Patient Reminder Card** with you or your child during your treatment and for 4 months after your child's last injection of Hyrimoz.
- If you have any further questions, please ask your doctor or pharmacist.
- This medicine has been prescribed for your child only. Do not pass it on to others. It may harm them, even if their signs of illness are the same as your child's.
- If your child gets any side effects, talk to your doctor or pharmacist. This includes any possible side effects not listed in this leaflet. See section 4.

What is in this leaflet

1. What Hyrimoz is and what it is used for
2. What you need to know before your child uses Hyrimoz
3. How to use Hyrimoz
4. Possible side effects
5. How to store Hyrimoz
6. Contents of the pack and other information
7. Instructions for use

1. What Hyrimoz is and what it is used for

Hyrimoz contains the active substance adalimumab, a medicine that acts on your body's immune (defence) system.

Hyrimoz is intended for the treatment of the following inflammatory diseases:

- polyarticular juvenile idiopathic arthritis,
- enthesitis-related arthritis
- paediatric plaque psoriasis,
- paediatric Crohn's disease,
- paediatric non-infectious uveitis.

The active substance in Hyrimoz, adalimumab, is a monoclonal antibody. Monoclonal antibodies are proteins that attach to a specific target in the body.

The target of adalimumab is another protein called tumour necrosis factor (TNF α), which is present at increased levels in the inflammatory diseases listed above. By attaching to TNF α , Hyrimoz blocks its action and reduces the inflammation in these diseases.

Polyarticular juvenile idiopathic arthritis

Polyarticular juvenile idiopathic arthritis is an inflammatory disease of the joints.

Hyrimoz is used to treat polyarticular juvenile idiopathic arthritis in children and adolescents aged 2 to 17 years. Patients may first be given other disease-modifying medicines, such as methotrexate. If these medicines do not work well enough, patients will be given Hyrimoz to treat their polyarticular juvenile idiopathic arthritis.

Enthesitis-related arthritis

Enthesitis-related arthritis is an inflammatory disease of the joints and the places where tendons join the bone.

Hyrimoz is used to treat enthesitis-related arthritis in children and adolescents aged 6 to 17 years.

Patients may first be given other disease-modifying medicines, such as methotrexate.

If these medicines do not work well enough, patients will be given Hyrimoz to treat their enthesitis-related arthritis.

Paediatric plaque psoriasis

Plaque psoriasis is an inflammatory skin condition that causes red, flaky, crusty patches of skin covered with silvery scales. Plaque psoriasis can also affect the nails, causing them to crumble, become thickened and lift away from the nail bed which can be painful. Psoriasis is believed to be caused by a problem with the body's immune system that leads to an increased production of skin cells.

Hyrimoz is also used to treat severe plaque psoriasis in children and adolescents aged 4 to 17 years for whom medicines applied to the skin and treatment with UV light have either not worked very well or are not suitable.

Paediatric Crohn's disease

Crohn's disease is an inflammatory disease of the gut.

Hyrimoz is used to treat moderate to severe Crohn's disease in children and adolescents aged 6 to 17 years.

Your child may first be given other medicines. If these medicines do not work well enough, your child will be given Hyrimoz to reduce the signs and symptoms of his/her disease.

Paediatric non-infectious uveitis

Non-infectious uveitis is an inflammatory disease affecting certain parts of the eye. The inflammation leads to a decrease of vision and/or the presence of floaters in the eye (black dots or wispy lines that move across the field of vision). Hyrimoz works by reducing this inflammation.

Hyrimoz is used to treat children from 2 years of age with chronic non-infectious uveitis with inflammation affecting the front of the eye.

Your child may first be given other medicines. If these medicines do not work well enough, your child will be given Hyrimoz to reduce the signs and symptoms of his/her disease.

2. What you need to know before your child uses Hyrimoz

Do not use Hyrimoz

- if your child is allergic to adalimumab or any of the other ingredients of this medicine (listed in section 6).
- if your child has a severe infection, including tuberculosis, sepsis (blood poisoning) or other opportunistic infections (unusual infections associated with a weakened immune system). It is important that you tell your doctor if your child shows symptoms of infections, e.g. fever, wounds, feeling tired, dental problems (see "Warnings and precautions").

- if your child has moderate or severe heart failure. It is important to tell your doctor if your child has had or has a serious heart condition (see “Warnings and precautions”).

Warnings and precautions

Talk to your doctor or pharmacist before using Hyrimoz.

Allergic reaction

- If your child has allergic reactions with symptoms such as chest tightness, wheezing, dizziness, swelling or rash, do not inject more Hyrimoz and contact your doctor immediately, since in rare cases, these reactions can be life-threatening.

Infections

- If your child has an infection, including long-term or localised infection (for example leg ulcer), consult your doctor before starting Hyrimoz. If you are unsure, contact your doctor.
- Your child might get infections more easily while he/she is receiving Hyrimoz treatment. This risk may increase if your child’s lung function is reduced. These infections may be more serious and include tuberculosis, infections caused by viruses, fungi, parasites or bacteria, or other unusual infectious organisms and sepsis (blood poisoning).
- In rare cases, these infections may be life-threatening. It is important to tell your doctor if your child shows symptoms such as fever, wounds, feeling tired or dental problems. Your doctor may recommend temporarily stopping Hyrimoz.

Tuberculosis (TB)

- As cases of tuberculosis have been reported in patients treated with adalimumab, your doctor will check your child for signs and symptoms of tuberculosis before starting Hyrimoz. This will include a thorough medical evaluation including your child’s medical history and screening tests (for example chest X-ray and a tuberculin test). The conduct and results of these tests should be recorded on your child’s **Patient Reminder Card**. It is very important that you tell your doctor if your child has ever had tuberculosis, or if he/she has been in close contact with someone who has had tuberculosis. Tuberculosis can develop during therapy even if your child has had preventative treatment for tuberculosis. If symptoms of tuberculosis (persistent cough, weight loss, lack of energy, mild fever), or any other infection appear during or after therapy tell your doctor immediately.

Travel/recurrent infection

- Tell your doctor if your child has lived or travelled in regions where fungal infections such as histoplasmosis, coccidioidomycosis or blastomycosis are very common.
- Tell your doctor if your child has a history of recurrent infections or other conditions that increase the risk of infections.

Hepatitis B virus

- Tell your doctor if your child is a carrier of the hepatitis B virus (HBV), if he/she has active HBV infection or if you think he/she might be at risk of getting HBV. Your doctor should test your child for HBV. Adalimumab can reactivate HBV infection in people who carry this virus. In some rare cases, especially if your child is taking other medicines that suppress the immune system, reactivation of HBV infection can be life-threatening.

Surgery or dental procedures

- If your child is about to have surgery or dental procedures tell your doctor that your child is taking Hyrimoz. Your doctor may recommend temporarily stopping Hyrimoz.

Demyelinating disease

- If your child has or develops demyelinating disease (a disease that affects the insulating layer around the nerves, such as multiple sclerosis), your doctor will decide if he/she should receive or continue to receive Hyrimoz. Tell your doctor immediately if he/she experiences symptoms like changes in vision, weakness in arms or legs or numbness or tingling in any part of the body.

Vaccine

- Certain vaccines contain living but weakened forms of disease-causing bacteria or viruses and should not be given during treatment with Hyrimoz in case they cause infections. Check with your doctor before your child receives any vaccines. It is recommended that, if possible, children be given all the scheduled vaccinations for their age before they start treatment with Hyrimoz.

If your child receives Hyrimoz while she is pregnant, her baby may be at higher risk for getting an infection for up to about five months after the last dose she received during pregnancy. It is important that you tell her baby's doctors and other health care professionals about your child's Hyrimoz use during her pregnancy so they can decide when her baby should receive any vaccine.

Heart failure

- It is important to tell your doctor if your child has had or has a serious heart condition. If your child has mild heart failure and is being treated with Hyrimoz, the heart failure status must be closely monitored by your doctor. If your child develops new or worsening symptoms of heart failure (e.g. shortness of breath, or swelling of your feet), you must contact your doctor immediately.

Fever, bruising, bleeding or looking pale

- In some patients the body may fail to produce enough of the blood cells that fight off infections or help stop bleeding. If your child develops a fever that does not go away, or he/she bruises or bleeds very easily or looks very pale, call your doctor right away. Your doctor may decide to stop treatment.

Cancer

- There have been very rare cases of certain kinds of cancer in children and adults taking adalimumab or other TNF α blockers. People with more serious rheumatoid arthritis who have had the disease for a long time may have a higher than average risk of getting lymphoma and leukaemia (cancers that affect blood cells and bone marrow). If your child takes Hyrimoz, the risk of getting lymphoma, leukaemia, or other cancers may increase. On rare occasions, a specific and severe type of lymphoma has been observed in patients taking adalimumab. Some of those patients were also treated with the medicines azathioprine or mercaptopurine. Tell your doctor if your child is taking azathioprine or mercaptopurine with Hyrimoz.
- In addition cases of non-melanoma skin cancer have been observed in patients taking adalimumab. If new areas of damaged skin appear during or after treatment or if existing marks or areas of damage change appearance, tell your doctor.
- There have been cases of cancers, other than lymphoma, in patients with a specific type of lung disease called chronic obstructive pulmonary disease (COPD) treated with another

TNF α blocker. If your child has COPD, or is a heavy smoker, you should discuss with your doctor whether treatment with a TNF α blocker is appropriate.

Autoimmune diseases

- On rare occasions, treatment with Hyrimoz could result in lupus-like syndrome. Contact your doctor, if symptoms such as persistent unexplained rash, fever, joint pain or tiredness occur.

Other medicines and Hyrimoz

Tell your doctor or pharmacist if your child is taking, has recently taken or might take any other medicines.

Hyrimoz can be taken together with methotrexate or certain disease-modifying anti-rheumatic agents (sulfasalazine, hydroxychloroquine, leflunomide and injectable gold preparations), corticosteroids or pain medications including non-steroidal anti-inflammatory drugs (NSAIDs).

Your child should not take Hyrimoz with medicines containing the active substances anakinra or abatacept due to increased risk of serious infection. The combination of adalimumab as well as other TNF-antagonists and anakinra or abatacept is not recommended based upon the possible increased risk for infections, including serious infections and other potential pharmacological interactions. If you have questions, please ask your doctor.

Pregnancy and breast-feeding

- Your child should consider the use of adequate contraception to prevent pregnancy and continue its use for at least 5 months after the last Hyrimoz treatment.
- If your child is pregnant, thinks she may be pregnant or is planning to have a baby, ask her doctor for advice before taking this medicine.
- Hyrimoz should only be used during a pregnancy if needed.
- According to a pregnancy study, there was no higher risk of birth defects when the mother had received adalimumab during pregnancy compared with mothers with the same disease who did not receive adalimumab.
- Hyrimoz can be used during breast-feeding.
- If your child receives Hyrimoz during her pregnancy, the baby may have a higher risk for getting an infection.
- It is important that you tell her baby's doctors and other health care professionals about her Hyrimoz use during her pregnancy before the baby receives any vaccine (for more information on vaccines see the "Warnings and precautions" section).

Driving and using machines

Hyrimoz may have a minor influence on the ability to drive, cycle or use machines. Room spinning sensation (vertigo) and vision disturbances may occur after taking Hyrimoz.

Hyrimoz contains sodium

This medicine contains less than 1 mmol of sodium (23 mg) per 0.2 ml dose, that is to say essentially 'sodium-free'.

3. How to use Hyrimoz

Always use this medicine exactly as your doctor or pharmacist has told you. Check with your doctor or

pharmacist if you are not sure.

The recommended doses for Hyrimoz in each of the approved uses are shown in the following table. Your doctor may prescribe another strength of Hyrimoz if your child needs different dose.

Polyarticular juvenile idiopathic arthritis		
Age or body weight	How much and how often to take?	Notes
Children, adolescents and adults from 2 years of age weighing 30 kg or more	40 mg every other week	Not applicable
Children, adolescents from 2 years of age weighing 10 kg to less than 30 kg	20 mg every other week	Not applicable

Enthesitis-related arthritis		
Age or body weight	How much and how often to take?	Notes
Children, adolescents and adults from 6 years of age weighing 30 kg or more	40 mg every other week	Not applicable
Children, adolescents from 6 years of age weighing 15 kg to less than 30 kg	20 mg every other week	Not applicable

Paediatric plaque psoriasis		
Age or body weight	How much and how often to take?	Notes
Children and adolescents from 4 to 17 years of age weighing 30 kg or more	First dose of 40 mg, followed by 40 mg one week later. Thereafter, the usual dose is 40 mg every other week.	Not applicable
Children and adolescents from 4 to 17 years of age weighing 15 kg to less than 30 kg	First dose of 20 mg, followed by 20 mg one week later. Thereafter, the usual dose is 20 mg every other week.	Not applicable

Paediatric Crohn's disease		
Age or body weight	How much and how often to take?	Notes
Children and adolescent from 6 to 17 years of age weighing 40 kg or more	First dose of 80 mg, followed by 40 mg two weeks later. If a faster response is required your doctor may prescribe a first dose of 160 mg, followed by 80 mg two weeks later. Thereafter the usual dose is 40 mg every other week.	If this dose does not work well enough, your child's doctor may increase the dose to 40 mg every week or 80 mg every other week.
Children and adolescents from 6 to 17 years of age weighing less than 40 kg	First dose of 40 mg, followed by 20 mg every other week starting two weeks later.	If this dose does not work well enough, your child's doctor may increase the dose

	<p>If a faster response is required, your doctor may prescribe a first dose of 80 mg, followed by 40 mg two weeks later.</p> <p>Thereafter the usual dose is 20 mg every other week.</p>	frequency to 20 mg every week.
--	--	--------------------------------

Paediatric non-infectious uveitis		
Age or body weight	How much and how often to take?	Notes
Children and adolescents from 2 years of age weighing 30 kg or more	40 mg every other week	Your doctor may also prescribe a first dose of 80 mg which may be administered one week prior to the start of the usual dose of 40 mg every other week. Hyrimoz is recommended for the use in combination with methotrexate.
Children and adolescents from 2 years of age weighing less than 30 kg	20 mg every other week	Your doctor may also prescribe a first dose of 40 mg which may be administered one week prior to the start of the usual dose of 20 mg every other week. Hyrimoz is recommended for the use in combination with methotrexate.

Method and route of administration

Hyrimoz is administered by injection under the skin (by subcutaneous injection).

Detailed instructions on how to inject Hyrimoz are provided in section 7, “**Instructions for use**”.

If you use more Hyrimoz than you should

If you accidentally inject Hyrimoz more frequently than you should, call your doctor or pharmacist and explain that your child has received more medication than required. Always take the outer carton of medicine with you, even if it is empty.

If you forget to use Hyrimoz

If you forget to give your child an injection, you should inject the next dose of Hyrimoz as soon as you remember. Then take your child’s next dose as you would have on the originally scheduled day, had you not forgotten a dose.

If you stop using Hyrimoz

The decision to stop using Hyrimoz should be discussed with your child’s doctor. The symptoms may return upon stopping treatment.

If you have any further questions on the use of this medicine, ask your doctor or pharmacist.

4. Possible side effects

Like all medicines, this medicine can cause side effects, although not everybody gets them. Most side effects are mild to moderate. However, some may be serious and require treatment. Side effects may occur up to 4 months or more after the last Hyrimoz injection.

Seek medical attention urgently, if you notice any of the following signs of allergic reaction or heart failure:

- severe rash, hives;
- swollen face, hands, feet;
- trouble breathing, swallowing;
- shortness of breath with physical activity or upon lying down or swelling of the feet.

Tell your doctor as soon as possible, if you notice any of the following:

- signs and symptoms of infection such as fever, feeling sick, wounds, dental problems, burning on urination, feeling weak or tired or coughing;
- symptoms of nerve problems such as tingling, numbness, double vision or arm or leg weakness;
- signs of skin cancer such as a bump or open sore that doesn't heal;
- signs and symptoms suggestive of blood disorders such as persistent fever, bruising, bleeding, paleness.

The following side effects have been observed with adalimumab:

Very common (may affect more than 1 in 10 people)

- injection site reactions (including pain, swelling, redness or itching);
- respiratory tract infections (including cold, runny nose, sinus infection, pneumonia);
- headache;
- abdominal (belly) pain;
- nausea and vomiting;
- rash;
- pain in the muscles.

Common (may affect up to 1 in 10 people)

- serious infections (including blood poisoning and influenza);
- intestinal infections (including gastroenteritis);
- skin infections (including cellulitis and shingles);
- ear infections;
- mouth infections (including tooth infections and cold sores);
- reproductive tract infections;
- urinary tract infection;
- fungal infections;
- joint infections;
- benign tumours;
- skin cancer;
- allergic reactions (including seasonal allergy);
- dehydration;
- mood swings (including depression);
- anxiety;
- difficulty sleeping;
- sensation disorders such as tingling, prickling or numbness;
- migraine;
- symptoms of nerve root compression (including low back pain and leg pain);
- vision disturbances;

- eye inflammation;
- inflammation of the eye lid and eye swelling;
- vertigo (sensation of room spinning);
- sensation of heart beating rapidly;
- high blood pressure;
- flushing;
- haematoma (a solid swelling with clotted blood);
- cough;
- asthma;
- shortness of breath;
- gastrointestinal bleeding;
- dyspepsia (indigestion, bloating, heart burn);
- acid reflux disease;
- sicca syndrome (including dry eyes and dry mouth);
- itching;
- itchy rash;
- bruising;
- inflammation of the skin (such as eczema);
- breaking of finger nails and toe nails;
- increased sweating;
- hair loss;
- new onset or worsening of psoriasis;
- muscle spasms;
- blood in urine;
- kidney problems;
- chest pain;
- oedema (a build-up of fluid in the body which causes the affected tissue to swell);
- fever;
- reduction in blood platelets which increases risk of bleeding or bruising;
- impaired healing.

Uncommon (may affect up to 1 in 100 people)

- unusual infections (which include tuberculosis and other infections) that occur when resistance to disease is lowered;
- neurological infections (including viral meningitis);
- eye infections;
- bacterial infections;
- diverticulitis (inflammation and infection of the large intestine);
- cancer, including cancer that affects the lymph system (lymphoma) and melanoma (a type of skin cancer);
- immune disorders that could affect the lungs, skin and lymph nodes (most commonly as a condition called sarcoidosis);
- vasculitis (inflammation of blood vessels);
- tremor (shaking);
- neuropathy (nerve damage);
- stroke;
- hearing loss, buzzing;
- sensation of heart beating irregularly such as skipped beats;
- heart problems that can cause shortness of breath or ankle swelling;
- heart attack;
- a sac in the wall of a major artery, inflammation and clot of a vein; blockage of a blood vessel;
- lung diseases causing shortness of breath (including inflammation);
- pulmonary embolism (blockage in an artery of the lung);

- pleural effusion (abnormal collection of fluid in the pleural space);
- inflammation of the pancreas which causes severe pain in the abdomen and back;
- difficulty in swallowing;
- facial oedema (swelling);
- gallbladder inflammation, gallbladder stones;
- fatty liver (build-up of fat in liver cells);
- night sweats;
- scar;
- abnormal muscle breakdown;
- systemic lupus erythematosus (an immune disorder including inflammation of skin, heart, lung, joints and other organ systems);
- sleep interruptions;
- impotence;
- inflammations.

Rare (may affect up to 1 in 1 000 people)

- leukaemia (cancer affecting the blood and bone marrow);
- severe allergic reaction with shock;
- multiple sclerosis;
- nerve disorders (such as inflammation of the optic nerve to the eye, and Guillain-Barré syndrome, a condition that may cause muscle weakness, abnormal sensations, tingling in the arms and upper body);
- heart stops pumping;
- pulmonary fibrosis (scarring of the lung);
- intestinal perforation (hole in the wall of the gut);
- hepatitis (liver inflammation);
- reactivation of hepatitis B infection;
- autoimmune hepatitis (inflammation of the liver caused by the body's own immune system);
- cutaneous vasculitis (inflammation of blood vessels in the skin);
- Stevens-Johnson syndrome (life-threatening reaction with flu-like symptoms and blistering rash);
- facial oedema (swelling) associated with allergic reactions;
- erythema multiforme (inflammatory skin rash);
- lupus-like syndrome;
- angioedema (localised swelling of the skin);
- lichenoid skin reaction (itchy reddish-purple skin rash).

Not known (frequency cannot be estimated from available data)

- hepatosplenic T-cell lymphoma (a rare blood cancer that is often fatal);
- Merkel cell carcinoma (a type of skin cancer);
- Kaposi's sarcoma, a rare cancer related to infection with human herpes virus 8. Kaposi's sarcoma most commonly appears as purple lesions on the skin;
- liver failure;
- worsening of a condition called dermatomyositis (seen as a skin rash accompanying muscle weakness).
- weight gain (for most patients, the weight gain was small)

Some side effects observed with adalimumab may not have symptoms and may only be discovered through blood tests. These include:

Very common (may affect more than 1 in 10 people)

- low blood measurements for white blood cells;

- low blood measurements for red blood cells;
- increased lipids in the blood;
- raised liver enzymes.

Common (may affect up to 1 in 10 people)

- high blood measurements for white blood cells;
- low blood measurements for platelets;
- increased uric acid in the blood;
- abnormal blood measurements for sodium;
- low blood measurements for calcium;
- low blood measurements for phosphate;
- high blood sugar;
- high blood measurements for lactate dehydrogenase;
- autoantibodies present in the blood;
- low blood potassium.

Uncommon (may affect up to 1 in 100 people)

- raised bilirubin measurement (liver blood test).

Rare (may affect up to 1 in 1 000 people)

- low blood measurements for white blood cells, red blood cells and platelet count.

Reporting of side effects

If your child gets any side effects, talk to your doctor or pharmacist. This includes any possible side effects not listed in this leaflet. You can also report side effects directly via the national reporting system listed in [Appendix V](#). By reporting side effects, you can help provide more information on the safety of this medicine.

5. How to store Hyrimoz

Keep this medicine out of the sight and reach of children.

Do not use this medicine after the expiry date which is stated on the label/blister/carton after EXP. The expiry date refers to the last day of that month.

Store in a refrigerator (2°C–8°C). Do not freeze.

Keep the pre-filled syringe in the outer carton in order to protect from light.

Alternative Storage:

When needed (for example when you are travelling), Hyrimoz may be stored at room temperature (up to 25°C) for a maximum period of 42 days – be sure to protect it from light. Once removed from the refrigerator for room temperature storage, your pre-filled syringe **must be used within 42 days or discarded**, even if it is later returned to the refrigerator. You should record the date when your pre-filled syringe is first removed from the refrigerator, and the date after which it should be discarded.

Do not throw away any medicines via wastewater or household waste. Ask your pharmacist how to throw away medicines you no longer use. These measures will help protect the environment.

6. Contents of the pack and other information

What Hyrimoz contains

- The active substance is adalimumab. Each pre-filled syringe contains 20 mg of adalimumab in 0.2 ml of solution.
- The other ingredients are adipic acid, mannitol (E 421), polysorbate 80 (E 433), hydrochloric acid (E 507), sodium hydroxide (E 524) and water for injections (see section 2 “Hyrimoz contains sodium”).

What Hyrimoz looks like and contents of the pack

Hyrimoz 20 mg solution for injection (injection) in pre-filled syringe for paediatric use is supplied as a 0.2 ml clear to slightly opalescent, colourless or slightly yellowish solution.

Hyrimoz is supplied in a single-use clear type I glass syringe with a stainless steel 29 gauge needle with finger flange, rubber needle cap (thermoplastic elastomer) and plastic plunger rod, containing 0.2 ml of solution.

Multipack carton contains 2 (2 packs of 1) pre-filled syringes of Hyrimoz.

Not all pack sizes may be marketed.

Hyrimoz is available as a pre-filled syringe and a pre-filled pen.

Marketing Authorisation Holder

Sandoz GmbH
Biochemiestr. 10
6250 Kundl
Austria

Manufacturer

Sandoz GmbH Schaftenaus
Biochemiestr. 10
6336 Langkampfen
Austria

Novartis Pharmaceutical Manufacturing GmbH
Biochemiestrasse 10
6336 Langkampfen
Austria

For any information about this medicine, please contact the local representative of the Marketing Authorisation Holder:

België/Belgique/Belgien

Sandoz nv/sa
Tél/Tel: +32 2 722 97 97

България

Сандоз България КЧТ
Тел.: +359 2 970 47 47

Lietuva

Sandoz Pharmaceuticals d.d filialas
Tel: +370 5 2636 037

Luxembourg/Luxemburg

Sandoz nv/sa (Belgique/Belgien)
Tél/Tel.: +32 2 722 97 97

Česká republika

Sandoz s.r.o.
Tel: +420 225 775 111

Danmark/Norge/Ísland/Sverige

Sandoz A/S
Tlf./Sími/Tel: +45 63 95 10 00

Deutschland

Hexal AG
Tel: +49 8024 908 0

Eesti

Sandoz d.d. Eesti filiaal
Tel: +372 665 2400

Ελλάδα

SANDOZ HELLAS MONOΠΡΟΣΩΠΗ Α.Ε.
Τηλ: +30 216 600 5000

España

Sandoz Farmacéutica, S.A.
Tel: +34 900 456 856

France

Sandoz SAS
Tél: +33 1 49 64 48 00

Hrvatska

Sandoz d.o.o.
Tel: +385 1 23 53 111

Ireland

Rowex Ltd.
Tel: + 353 27 50077

Italia

Sandoz S.p.A.
Tel: +39 02 96541

Κύπρος

SANDOZ HELLAS MONOΠΡΟΣΩΠΗ Α.Ε.
(Ελλάδα)
Τηλ: +30 216 600 5000

Latvija

Sandoz d.d. Latvia filiāle
Tel: +371 67 892 006

Magyarország

Sandoz Hungária Kft.
Tel.: +36 1 430 2890

Malta

Sandoz Pharmaceuticals d.d.
Tel: +356 99644126

Nederland

Sandoz B.V.
Tel: +31 36 52 41 600

Österreich

Sandoz GmbH
Tel: +43 5338 2000

Polska

Sandoz Polska Sp. z o.o.
Tel.: +48 22 209 70 00

Portugal

Sandoz Farmacêutica Lda.
Tel: +351 21 000 86 00

România

Sandoz Pharmaceuticals SRL
Tel: +40 21 407 51 60

Slovenija

Sandoz farmacevtska družba d.d.
Tel: +386 1 580 29 02

Slovenská republika

Sandoz d.d. - organizačná zložka
Tel: +421 2 48 200 600

Suomi/Finland

Sandoz A/S
Puh/Tel: +358 10 6133 400

United Kingdom (Northern Ireland)

Sandoz GmbH
Tel: +43 5338 2000

This leaflet was last revised in

Other sources of information

Detailed information on this medicine is available on the European Medicines Agency web site:

<https://www.ema.europa.eu>.

7. Instructions for use

To help avoid possible infections and to ensure that you use the medicine correctly, it is important that you follow these instructions.

Be sure that you read, understand, and follow these Instructions for Use before injecting Hyrimoz. Your healthcare provider should show you how to prepare and inject Hyrimoz properly using the single-dose pre-filled syringe before you use it for the first time. Talk to your healthcare provider if you have any questions.

Your Hyrimoz single-use pre-filled syringe

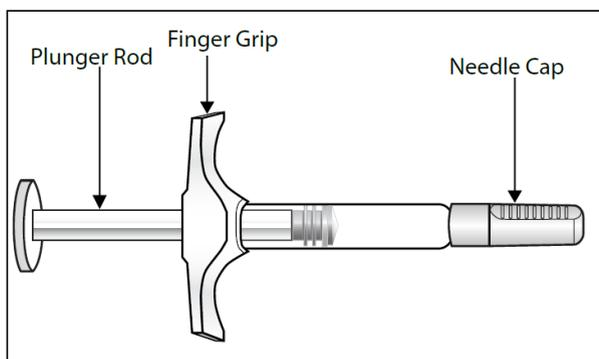

Figure A: Hyrimoz pre-filled syringe

It is important that you:

- **do not use** the pre-filled syringe if the seal of the outer carton is broken, as it may not be safe to use.
- **do not** open the inner carton until you are ready to use the Hyrimoz pre-filled syringe.
- **never** leave the pre-filled syringe unattended where others might tamper with it.
- if you drop your syringe, **do not use** it if it looks damaged, or if you dropped it with the needle cap removed.
- **do not** remove the needle cap until just before you give the injection.
- **Inject Hyrimoz** 15–30 minutes after taking it out of the refrigerator for a more comfortable injection.
- throw away the used syringe right away after use. **Do not re-use a syringe.** See “4. Disposing of used syringes” at the end of these Instructions for Use.
- consult your healthcare provider or nurse for advise on appropriate injection site and injection technique if you are underweight or if you are injecting a child.

How should you store Hyrimoz single-dose pre-filled syringe?

- Store the **Hyrimoz** pre-filled syringe in the original carton to protect from light.
- Store your outer carton of pre-filled syringes in a refrigerator, between 2°C to 8°C.
- If needed (for example if you are travelling), you may store the pre-filled syringe at room temperature up to 25°C for up to 42 days.
- Throw away the pre-filled syringe that has been stored at room temperature after 42 days.
- You should record the date when your pre-filled syringe is first removed from the refrigerator, and the date after which it should be discarded.
- **Do not** store your pre-filled syringe in extreme heat or cold.
- **Do not** freeze your pre-filled syringe.
- **Do not** use your pre-filled syringe after the expiry date shown on the outer carton or syringe label. If it has expired, return the entire pack to the pharmacy.

Keep Hyrimoz and all medicines out of the reach of children.

What do you need for your injection?

Place the following items on a clean, flat surface.

Included in your pre-filled syringe carton is:

- Hyrimoz pre-filled syringe (see **Figure A**). Each pre-filled syringe contains 20 mg/0.2 ml of adalimumab.

Not included in your Hyrimoz pre-filled syringe carton are (see **Figure B**):

- Alcohol wipe
- Cotton ball or gauze
- Sharps disposal container; See “**4. Disposing of used syringes**” at the end of these Instructions for Use.
- Adhesive bandage

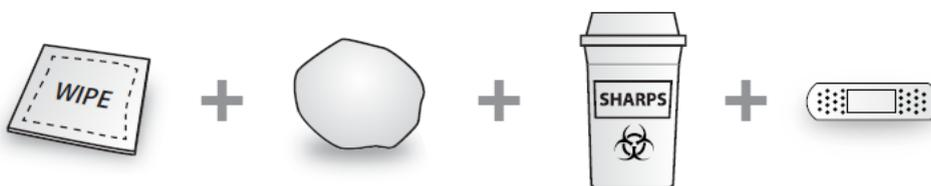

Figure B: items not included in the carton

Preparing the pre-filled syringe

- For a more comfortable injection, take the carton containing the pre-filled syringe out of the refrigerator and leave it **unopened** on your work surface for about 15 to 30 minutes so that it reaches room temperature.
- Remove the pre-filled syringe out of the carton box and inspect it. The solution should be colourless or slightly yellowish as well as clear to slightly opalescent. **Do not use** if any particulates and/or discolorations are observed. If you are concerned with the appearance of the solution, then contact your pharmacist for assistance.
- **Do not** use the pre-filled syringe if it is broken. Return the entire product pack to the pharmacy.
- Look at the expiry date (EXP) on your pre-filled syringe. Do not use your pre-filled syringe if the expiry date has passed.

Contact your pharmacist if the pre-filled syringe fails any of the above mentioned checks.

1. Choosing your injection site:

The injection site is the place on the body where you are going to inject the **Hyrimoz** pre-filled syringe.

- The recommended injection site is the front of the thighs. You may also use the lower abdomen, but not the area 5 cm around your navel (belly button) (see *Figure C*).
- Choose a different site each time you give an injection.
- **Do not** inject into areas where the skin is tender, bruised, red, scaly, or hard. Avoid areas with scars or stretch marks.
- If you have psoriasis, you should **not** inject directly into areas with psoriasis plaques.

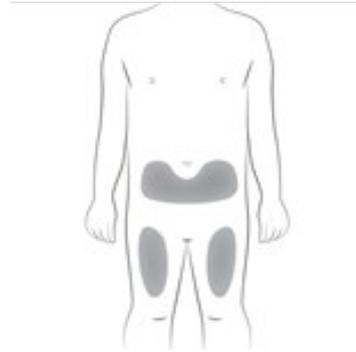

Figure C: choose your injection site

2. Cleaning your injection site:

- When you are ready to use the pre-filled syringe, wash your hands thoroughly with soap and water.
- Using a circular motion, clean the injection site with an alcohol wipe. Let it dry before injecting (see *Figure D*).
- **Do not** touch this area again before giving the injection. Allow the skin to dry before injecting. Do not fan or blow on the clean area.

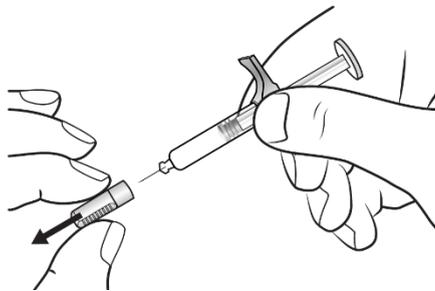
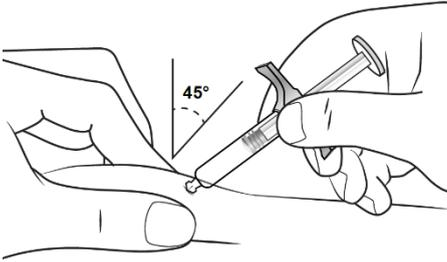
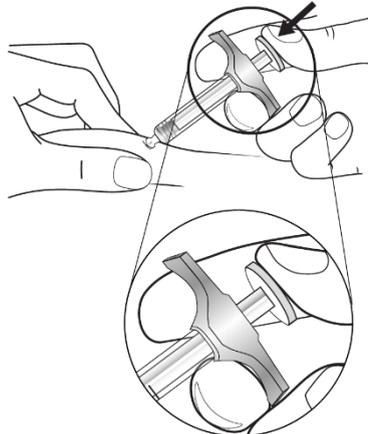

Figure D: clean your injection site

3. Giving your injection:	
<ul style="list-style-type: none"> Carefully pull the needle cap straight off to remove it from the syringe (see <i>Figure E</i>). Throw away (discard) the needle cap. You may see a drop of liquid at the end of the needle. This is normal. 	 <p><i>Figure E: pull the needle cap off</i></p>
<ul style="list-style-type: none"> Gently pinch the skin at the injection site (see <i>Figure F</i>). Insert the needle into the skin at a 45° degree angle, as shown (see <i>Figure F</i>). 	 <p><i>Figure F: insert the needle</i></p>
<ul style="list-style-type: none"> Hold the single-dose pre-filled syringe as shown (see <i>Figure G</i>). Slowly press down on the plunger as far as it will go. Keep the plunger pressed fully down while you hold the syringe in place for 5 seconds. Carefully lift the needle straight out from the injection site and let go of the skin. There may be a small amount of blood at the injection site. You can press a cotton ball or gauze onto the injection site and hold it for 10 seconds. Do not rub the injection site. You may cover the injection site with a small adhesive bandage, if needed. 	 <p><i>Figure G: press down the plunger</i></p>

4. Disposing of used pre-filled syringes:

- Dispose of the used syringe in a sharps container (closable, puncture-resistant container). For the safety and health of you and others, needles and used syringes must never be re-used.
- Do not throw away any medicines via wastewater or household waste. Ask your doctor or pharmacist how to throw away medicines you no longer use. These measures will help protect the environment. Any unused product or waste material should be disposed of in accordance with local requirements.

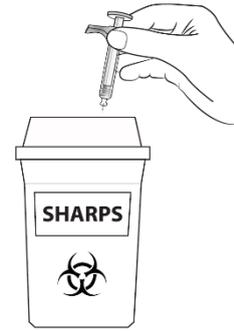

Figure H: dispose of the used Pre-filled syringe

If you have any questions, please talk to a doctor, pharmacist or nurse who is familiar with Hyrimoz.

Package leaflet: Information for the patient

Hyrimoz 40 mg solution for injection in pre-filled syringe adalimumab **40 mg/0.8 ml**

Read all of this leaflet carefully before you start using this medicine because it contains important information for you.

- Keep this leaflet. You may need to read it again.
- Your doctor will also give you a **Patient Reminder Card**, which contains important safety information that you need to be aware of before you are given Hyrimoz and during treatment with Hyrimoz. Keep this **Patient Reminder Card** with you during your treatment and for 4 months after your (or your child's) last injection of Hyrimoz.
- If you have any further questions, please ask your doctor or pharmacist.
- This medicine has been prescribed for you only. Do not pass it on to others. It may harm them, even if their signs of illness are the same as yours.
- If you get any side effects, talk to your doctor or pharmacist. This includes any possible side effects not listed in this leaflet. See section 4.

What is in this leaflet

1. What Hyrimoz is and what it is used for
2. What you need to know before you use Hyrimoz
3. How to use Hyrimoz
4. Possible side effects
5. How to store Hyrimoz
6. Contents of the pack and other information
7. Instructions for use

1. What Hyrimoz is and what it is used for

Hyrimoz contains the active substance adalimumab, a medicine that acts on your body's immune (defence) system.

Hyrimoz is intended for the treatment of the following inflammatory diseases:

- rheumatoid arthritis,
- polyarticular juvenile idiopathic arthritis,
- enthesitis-related arthritis,
- ankylosing spondylitis,
- axial spondyloarthritis without radiographic evidence of ankylosing spondylitis,
- psoriatic arthritis,
- psoriasis,
- hidradenitis suppurativa,
- Crohn's disease,
- ulcerative colitis and
- non-infectious uveitis.

The active substance in Hyrimoz, adalimumab, is a monoclonal antibody. Monoclonal antibodies are proteins that attach to a specific target in the body.

The target of adalimumab is another protein called tumour necrosis factor (TNF α), which is present at increased levels in the inflammatory diseases listed above. By attaching to TNF α , Hyrimoz blocks its action and reduces the inflammation in these diseases.

Rheumatoid arthritis

Rheumatoid arthritis is an inflammatory disease of the joints.

Hyrimoz is used to treat rheumatoid arthritis in adults. If you have moderate to severe active rheumatoid arthritis, you may first be given other disease-modifying medicines, such as methotrexate. If these medicines do not work well enough, you will be given Hyrimoz to treat your rheumatoid arthritis.

Hyrimoz can also be used to treat severe, active and progressive rheumatoid arthritis without previous methotrexate treatment.

Hyrimoz can slow down the damage to the cartilage and bone of the joints caused by the disease and improve physical function.

Usually, Hyrimoz is used with methotrexate. If your doctor considers that methotrexate is inappropriate, Hyrimoz can be given alone.

Polyarticular juvenile idiopathic arthritis and enthesitis-related arthritis

Polyarticular juvenile idiopathic arthritis and enthesitis-related arthritis are inflammatory diseases of the joints that usually first appear in childhood.

Hyrimoz is used to treat polyarticular juvenile idiopathic arthritis in children and adolescents aged 2 to 17 years and enthesitis-related arthritis in children and adolescents aged 6 to 17 years. Patients may first be given other disease-modifying medicines, such as methotrexate. If these medicines do not work well enough, patients will be given Hyrimoz to treat their polyarticular juvenile idiopathic arthritis or enthesitis-related arthritis.

Ankylosing spondylitis and axial spondyloarthritis without radiographic evidence of ankylosing spondylitis

Ankylosing spondylitis and axial spondyloarthritis without radiographic evidence of ankylosing spondylitis are inflammatory diseases of the spine.

Hyrimoz is used in adults to treat these conditions. If you have ankylosing spondylitis or axial spondyloarthritis without radiographic evidence of ankylosing spondylitis, you will first be given other medicines. If these medicines do not work well enough, you will be given Hyrimoz to reduce the signs and symptoms of your disease.

Plaque psoriasis in adults and children

Plaque psoriasis is an inflammatory skin condition that causes red, flaky, crusty patches of skin covered with silvery scales. Plaque psoriasis can also affect the nails, causing them to crumble, become thickened and lift away from the nail bed which can be painful. Psoriasis is believed to be caused by a problem with the body's immune system that leads to an increased production of skin cells.

Hyrimoz is used to treat moderate to severe plaque psoriasis in adults. Hyrimoz is also used to treat severe plaque psoriasis in children and adolescents aged 4 to 17 years for whom medicines applied to the skin and treatment with UV light have either not worked very well or are not suitable.

Psoriatic arthritis

Psoriatic arthritis is an inflammatory disease of the joints associated with psoriasis.

Hyrimoz is used to treat psoriatic arthritis in adults. Hyrimoz can slow down the damage to the cartilage and bone of the joints caused by the disease and improve physical function.

Hidradenitis suppurativa in adults and adolescents

Hidradenitis suppurativa (sometimes called acne inversa) is a long-term and often painful inflammatory skin disease. Symptoms may include tender nodules (lumps) and abscesses (boils) that may leak pus.

It most commonly affects specific areas of the skin, such as under the breasts, the armpits, inner thighs, groin and buttocks. Scarring may also occur in affected areas.

Hyrimoz is used to treat hidradenitis suppurativa in adults and adolescents from 12 years of age. Hyrimoz can reduce the number of nodules and abscesses you have, and the pain that is often associated with the disease. You may first be given other medicines. If these medicines do not work well enough, you will be given Hyrimoz.

Crohn's disease in adults and children

Crohn's disease is an inflammatory disease of the gut.

Hyrimoz is used to treat Crohn's disease in adults and children aged 6 to 17 years. If you have Crohn's disease you will first be given other medicines. If you do not respond well enough to these medicines, you will be given Hyrimoz to reduce the signs and symptoms of your Crohn's disease.

Ulcerative colitis in adults and children

Ulcerative colitis is an inflammatory disease of the large intestine.

Hyrimoz is used to treat moderate to severe ulcerative colitis in adults children aged 6 to 17 years. If you have ulcerative colitis you may first be given other medicines. If these medicines do not work well enough, you will be given Hyrimoz to reduce the signs and symptoms of your disease.

Non-infectious uveitis in adults and children

Non-infectious uveitis is an inflammatory disease affecting certain parts of the eye. The inflammation leads to a decrease of vision and/or the presence of floaters in the eye (black dots or wispy lines that move across the field of vision). Hyrimoz works by reducing this inflammation.

Hyrimoz is used to treat

- adults with non-infectious uveitis with inflammation affecting the back of the eye.
- children from 2 years of age with chronic non-infectious uveitis with inflammation affecting the front of the eye.

2. What you need to know before you use Hyrimoz

Do not use Hyrimoz

- if you are allergic to adalimumab or any of the other ingredients of this medicine (listed in section 6).

- if you have a severe infection, including tuberculosis, sepsis (blood poisoning) or other opportunistic infections (unusual infections associated with a weakened immune system). It is important that you tell your doctor if you have symptoms of infections, e.g. fever, wounds, feeling tired, dental problems (see “Warnings and precautions”).
- if you have moderate or severe heart failure. It is important to tell your doctor if you have had or have a serious heart condition (see “Warnings and precautions”).

Warnings and precautions

Talk to your doctor or pharmacist before using Hyrimoz.

Allergic reaction

- If you have allergic reactions with symptoms such as chest tightness, wheezing, dizziness, swelling or rash, do not inject more Hyrimoz and contact your doctor immediately, since in rare cases, these reactions can be life-threatening.

Infection

- If you have an infection, including long-term or localised infection (for example leg ulcer), consult your doctor before starting Hyrimoz. If you are unsure, contact your doctor.
- You might get infections more easily while you are receiving Hyrimoz treatment. This risk may increase if your lung function is reduced. These infections may be more serious and include tuberculosis, infections caused by viruses, fungi, parasites or bacteria, or other unusual infectious organisms and sepsis (blood poisoning).
- In rare cases, these infections may be life-threatening. It is important to tell your doctor if you get symptoms such as fever, wounds, feeling tired or dental problems. Your doctor may recommend temporarily stopping Hyrimoz.

Tuberculosis (TB)

- As cases of tuberculosis have been reported in patients treated with adalimumab, your doctor will check you for signs and symptoms of tuberculosis before starting Hyrimoz. This will include a thorough medical evaluation including your medical history and screening tests (for example chest X-ray and a tuberculin test). The conduct and results of these tests should be recorded on your Patient Reminder Card. It is very important that you tell your doctor if you have ever had tuberculosis, or if you have been in close contact with someone who has had tuberculosis. Tuberculosis can develop during therapy even if you have had preventative treatment for tuberculosis. If symptoms of tuberculosis (persistent cough, weight loss, listlessness, mild fever), or any other infection appear during or after therapy tell your doctor immediately.

Travel/recurrent infection

- Tell your doctor if you have lived or travelled in regions where fungal infections such as histoplasmosis, coccidioidomycosis or blastomycosis are common.
- Tell your doctor if you have a history of recurrent infections or other conditions that increase the risk of infections.

Hepatitis B virus

- Tell your doctor if you are a carrier of the hepatitis B virus (HBV), if you have active HBV infection or if you think you might be at risk of contracting HBV. Your doctor should test you for HBV. Adalimumab can reactivate HBV infection in people who carry this virus. In some

rare cases, especially if you are taking other medicines that suppress the immune system, reactivation of HBV infection can be life-threatening.

Age over 65 years

- If you are over 65 years you may be more susceptible to infections while taking Hyrimoz. You and your doctor should pay special attention to signs of infection while you are being treated with Hyrimoz. It is important to tell your doctor if you get symptoms of infections, such as fever, wounds, feeling tired or dental problems.

Surgery or dental procedures

- If you are about to have surgery or dental procedures tell your doctor that you are taking Hyrimoz. Your doctor may recommend temporarily stopping Hyrimoz.

Demyelinating disease

- If you have or develop demyelinating disease (a disease that affects the insulating layer around the nerves, such as multiple sclerosis), your doctor will decide if you should receive or continue to receive Hyrimoz. Tell your doctor immediately if you get symptoms like changes in your vision, weakness in your arms or legs or numbness or tingling in any part of your body.

Vaccine

- Certain vaccines contain living but weakened forms of disease-causing bacteria or viruses and should not be given during treatment with Hyrimoz in case they cause infections. Check with your doctor before you receive any vaccines. It is recommended that, if possible, children be given all the scheduled vaccinations for their age before they start treatment with Hyrimoz. If you receive Hyrimoz while you are pregnant, your baby may be at higher risk for getting an infection for up to about five months after the last dose you received during pregnancy. It is important that you tell your baby's doctors and other health care professionals about your Hyrimoz use during your pregnancy so they can decide when your baby should receive any vaccine.

Heart failure

- It is important to tell your doctor if you have had or have a serious heart condition. If you have mild heart failure and you are being treated with Hyrimoz, your heart failure status must be closely monitored by your doctor. If you develop new or worsening symptoms of heart failure (e.g. shortness of breath, or swelling of your feet), you must contact your doctor immediately.

Fever, bruising, bleeding or looking pale

- In some patients the body may fail to produce enough of the blood cells that fight off infections or help you to stop bleeding. If you develop a fever that does not go away, or you bruise or bleed very easily or look very pale, call your doctor right away. Your doctor may decide to stop treatment.

Cancer

- There have been very rare cases of certain kinds of cancer in children and adults taking adalimumab or other TNF α blockers. People with more serious rheumatoid arthritis who have had the disease for a long time may have a higher than average risk of getting lymphoma and leukaemia (cancers that affect blood cells and bone marrow). If you take Hyrimoz the risk of getting lymphoma, leukaemia, or other cancers may increase. On rare occasions, a specific and severe type of lymphoma has been observed in patients taking adalimumab. Some of those

patients were also treated with the medicines azathioprine or mercaptopurine. Tell your doctor if you are taking azathioprine or mercaptopurine with Hyrimoz.

- In addition cases of non-melanoma skin cancer have been observed in patients taking adalimumab. If new areas of damaged skin appear during or after treatment or if existing marks or areas of damage change appearance, tell your doctor.
- There have been cases of cancers, other than lymphoma, in patients with a specific type of lung disease called chronic obstructive pulmonary disease (COPD) treated with another TNF α blocker. If you have COPD, or are a heavy smoker, you should discuss with your doctor whether treatment with a TNF α blocker is appropriate for you.

Autoimmune diseases

- On rare occasions, treatment with Hyrimoz could result in lupus-like syndrome. Contact your doctor, if symptoms such as persistent unexplained rash, fever, joint pain or tiredness occur.

Children and adolescents

- Vaccinations: if possible, children should be up to date with all vaccinations before using Hyrimoz.
- Do not give Hyrimoz to children with polyarticular juvenile idiopathic arthritis below the age of 2 years.

Other medicines and Hyrimoz

Tell your doctor or pharmacist if you are taking, have recently taken or might take any other medicines.

Hyrimoz can be taken together with methotrexate or certain disease-modifying anti-rheumatic agents (sulfasalazine, hydroxychloroquine, leflunomide and injectable gold preparations), corticosteroids or pain medications including non-steroidal anti-inflammatory drugs (NSAIDs).

You should not take Hyrimoz with medicines containing the active substances anakinra or abatacept due to increased risk of serious infection. The combination of adalimumab as well as other TNF-antagonists and anakinra or abatacept is not recommended based upon the possible increased risk for infections, including serious infections and other potential pharmacological interactions. If you have questions, please ask your doctor.

Pregnancy and breast-feeding

- You should consider the use of adequate contraception to prevent pregnancy and continue its use for at least 5 months after the last Hyrimoz treatment.
- If you are pregnant, think you may be pregnant or are planning to have a baby, ask your doctor for advice before taking this medicine.
- Hyrimoz should only be used during a pregnancy if needed.
- According to a pregnancy study, there was no higher risk of birth defects when the mother had received adalimumab during pregnancy compared with mothers with the same disease who did not receive adalimumab.
- Hyrimoz can be used during breast-feeding.
- If you receive Hyrimoz during your pregnancy, your baby may have a higher risk for getting an infection.

- It is important that you tell your baby’s doctors and other health care professionals about your Hyrimoz use during your pregnancy before the baby receives any vaccine (for more information on vaccines see the “Warnings and precautions” section).

Driving and using machines

Hyrimoz may have a minor influence on your ability to drive, cycle or use machines. Room spinning sensation (vertigo) and vision disturbances may occur after taking Hyrimoz.

Hyrimoz contains sodium

This medicine contains less than 1 mmol of sodium (23 mg) per 0.8 ml dose, that is to say essentially ‘sodium-free’.

3. How to use Hyrimoz

Always use this medicine exactly as your doctor or pharmacist has told you. Check with your doctor or pharmacist if you are not sure.

Hyrimoz is available as a 40 mg pen as well as 20 mg and 40 mg pre-filled syringes for patients to administer a full 20 mg or 40 mg dose.

Rheumatoid arthritis, psoriatic arthritis, ankylosing spondylitis or axial spondyloarthritis without radiographic evidence of ankylosing spondylitis		
Age and body weight	How much and how often to take?	Notes
Adults	40 mg every other week as a single dose	In rheumatoid arthritis, methotrexate is continued while using Hyrimoz. If your doctor determines that methotrexate is inappropriate, Hyrimoz can be given alone. If you have rheumatoid arthritis and you do not receive methotrexate with your Hyrimoz therapy, your doctor may decide to give 40 mg Hyrimoz every week or 80 mg every other week.

Polyarticular juvenile idiopathic arthritis		
Age and body weight	How much and how often to take?	Notes
Children, adolescents and adults from 2 years of age weighing 30 kg or more	40 mg every other week	Not applicable
Children, adolescents from 2 years of age weighing 10 kg to less than 30 kg	20 mg every other week	Not applicable

Enthesitis-related arthritis		
Age and body weight	How much and how often to take?	Notes
Children, adolescents and adults from 6 years of age weighing 30 kg or more	40 mg every other week	Not applicable
Children and adolescents from 6 years of age weighing 15 kg to less than 30 kg	20 mg every other week	Not applicable

Psoriasis		
Age and body weight	How much and how often to take?	Notes
Adults	First dose of 80 mg (as two 40 mg injections in one day), followed by 40 mg given every other week starting one week after the first dose.	You should continue to inject Hyrimoz for as long as your doctor has told you. If this dose does not work well enough, your doctor may increase the dose to 40 mg every week or 80 mg every other week.

Paediatric plaque psoriasis		
Age and body weight	How much and how often to take?	Notes
Children and adolescents from 4 to 17 years of age weighing 30 kg or more	First dose of 40 mg, followed by 40 mg one week later. Thereafter, the usual dose is 40 mg every other week.	Not applicable
Children and adolescents from 4 to 17 years of age weighing 15 kg to less than 30 kg	First dose of 20 mg, followed by 20 mg one week later. Thereafter, the usual dose is 20 mg every other week.	Not applicable

Hidradenitis suppurativa		
Age and body weight	How much and how often to take?	Notes
Adults	<p>First dose of 160 mg (as four 40 mg injections in one day or two 40 mg injections per day for two consecutive days), followed by an 80 mg dose (as two 40 mg injections on the same day) two weeks later.</p> <p>After two further weeks, continue with a dose of 40 mg every week or 80 mg every other week, as prescribed by your doctor.</p>	It is recommended that you use an antiseptic wash daily on the affected areas.
Adolescents from 12 to 17 years of age weighing 30 kg or more	First dose of 80 mg (as two 40 mg injections in one day), followed by 40 mg every other week starting one week later.	<p>If this dose does not work well enough, your doctor may increase the dose to 40 mg every week or 80 mg every other week.</p> <p>It is recommended that you use an antiseptic wash daily on the affected areas.</p>

Crohn's disease		
Age and body weight	How much and how often to take?	Notes
Adults	<p>First dose of 80 mg (as two 40 mg injections in one day), followed by 40 mg every other week starting two weeks later.</p> <p>If a faster response is required your doctor may prescribe a first dose of 160 mg (as four 40 mg injections in one day or two 40 mg injections per day for two consecutive days), followed by 80 mg (as two 40 mg injections in one day) two weeks later.</p> <p>Thereafter the usual dose is 40 mg every other week.</p>	If this dose does not work well enough, your doctor may increase the dose to 40 mg every week or 80 mg every other week.

Paediatric Crohn's disease		
Age and body weight	How much and how often to take?	Notes
Children and adolescent from 6 to 17 years of age weighing 40 kg or more	<p>First dose of 80 mg (as two 40 mg injections in one day), followed by 40 mg every other week starting two weeks later.</p> <p>If a faster response is required your doctor may prescribe a first dose of 160 mg (as four 40 mg injections in one day or two 40 mg injections per day for two consecutive days), followed by 80 mg (as two 40 mg injections in one day) two weeks later.</p> <p>Thereafter the usual dose is 40 mg every other week.</p>	If this dose does not work well enough, your child's doctor may increase the dose to 40 mg every week or 80 mg every other week.
Children and adolescents from 6 to 17 years of age weighing less than 40 kg	<p>First dose of 40 mg, followed by 20 mg every other week starting two weeks later.</p> <p>If a faster response is required, your doctor may prescribe a first dose of 80 mg (as two 40 mg injections in one day), followed by 40 mg two weeks later.</p> <p>Thereafter the usual dose is 20 mg every other week.</p>	If this dose does not work well enough, your child's doctor may increase the dose frequency to 20 mg every week.

Ulcerative colitis		
Age and body weight	How much and how often to take?	Notes
Adults	<p>First dose is 160 mg (as four 40 mg injections in one day or as two 40 mg injections per day for two consecutive days), followed by 80 mg (as two 40 mg injections in one day) two weeks later.</p> <p>Thereafter, the usual dose is 40 mg every other week.</p>	If this dose does not work well enough, your doctor may increase the dose to 40 mg every week or 80 mg every other week.

Paediatric ulcerative colitis		
Age and body weight	How much and how often to take?	Notes
Children and adolescents from 6 years of age weighing 40 kg or more	<p>First dose is 160 mg (as four 40 mg injections in one day or two 40 mg injections per day for two consecutive days) initially, followed by 80 mg (as</p>	Patients who turn 18 years of age while on 80 mg every other week, should continue their prescribed dose.

	two 40 mg injections in one day) two weeks later. Thereafter the usual dose is 80 mg every other week (as two 40 mg injections in one day).	
Children and adolescents from 6 years of age weighing less than 40 kg	First dose is 80 mg (as two 40 mg injections in one day) initially followed by 40 mg (as one 40 mg injection) two weeks later. Thereafter, the usual dose is 40 mg every other week.	Patients who turn 18 years of age while on 40 mg every other week, should continue their prescribed dose.

Non-infectious uveitis		
Age and body weight	How much and how often to take?	Notes
Adults	First dose of 80 mg (as two 40 mg injections), followed by 40 mg every other week starting one week after the first dose.	In non-infectious uveitis, corticosteroids or other medicines that influence the immune system may be continued while using Hyrimoz. Hyrimoz can also be given alone. You should continue to inject Hyrimoz for as long as your doctor has told you.
Children and adolescents from 2 years of age weighing 30 kg or more	40 mg every other week with methotrexate.	Your doctor may also prescribe a first dose of 80 mg which may be administered one week prior to the start of the usual dose.
Children and adolescents from 2 years of age weighing less than 30 kg	20 mg every other week with methotrexate.	Your doctor may also prescribe a first dose of 40 mg which may be administered one week prior to the start of the usual dose.

Method and route of administration

Hyrimoz is administered by injection under the skin (by subcutaneous injection).

Detailed instructions on how to inject Hyrimoz are provided in section 7, “**Instructions for use**”.

If you use more Hyrimoz than you should

If you accidentally inject Hyrimoz more frequently than you should, call your doctor or pharmacist and explain that you have taken more than required. Always take the outer carton of medicine with you, even if it is empty.

If you forget to use Hyrimoz

If you forget to give yourself an injection, you should inject the next dose of Hyrimoz as soon as you remember. Then take your next dose as you would have on your originally scheduled day, had you not forgotten a dose.

If you stop using Hyrimoz

The decision to stop using Hyrimoz should be discussed with your doctor. Your symptoms may return upon stopping treatment.

If you have any further questions on the use of this medicine, ask your doctor or pharmacist.

4. Possible side effects

Like all medicines, this medicine can cause side effects, although not everybody gets them. Most side effects are mild to moderate. However, some may be serious and require treatment. Side effects may occur up to 4 months or more after the last Hyrimoz injection.

Seek medical attention urgently, if you notice any of the following signs of allergic reaction or heart failure:

- severe rash, hives;
- swollen face, hands, feet;
- trouble breathing, swallowing;
- shortness of breath with exertion or upon lying down or swelling of the feet.

Tell your doctor as soon as possible, if you notice any of the following:

- signs and symptoms of infection such as fever, feeling sick, wounds, dental problems, burning on urination, feeling weak or tired or coughing;
- symptoms of nerve problems such as tingling, numbness, double vision or arm or leg weakness;
- signs of skin cancer such as a bump or open sore that doesn't heal;
- signs and symptoms suggestive of blood disorders such as persistent fever, bruising, bleeding, paleness.

The following side effects have been observed with adalimumab:

Very common (may affect more than 1 in 10 people)

- injection site reactions (including pain, swelling, redness or itching);
- respiratory tract infections (including cold, runny nose, sinus infection, pneumonia);
- headache;
- abdominal (belly) pain;
- nausea and vomiting;
- rash;
- pain in the muscles.

Common (may affect up to 1 in 10 people)

- serious infections (including blood poisoning and influenza);
- intestinal infections (including gastroenteritis);
- skin infections (including cellulitis and shingles);
- ear infections;
- mouth infections (including tooth infections and cold sores);
- reproductive tract infections;
- urinary tract infection;

- fungal infections;
- joint infections;
- benign tumours;
- skin cancer;
- allergic reactions (including seasonal allergy);
- dehydration;
- mood swings (including depression);
- anxiety;
- difficulty sleeping;
- sensation disorders such as tingling, prickling or numbness;
- migraine;
- symptoms of nerve root compression (including low back pain and leg pain);
- vision disturbances;
- eye inflammation;
- inflammation of the eye lid and eye swelling;
- vertigo (sensation of room spinning);
- sensation of heart beating rapidly;
- high blood pressure;
- flushing;
- haematoma (a solid swelling with clotted blood);
- cough;
- asthma;
- shortness of breath;
- gastrointestinal bleeding;
- dyspepsia (indigestion, bloating, heart burn);
- acid reflux disease;
- sicca syndrome (including dry eyes and dry mouth);
- itching;
- itchy rash;
- bruising;
- inflammation of the skin (such as eczema);
- breaking of finger nails and toe nails;
- increased sweating;
- hair loss;
- new onset or worsening of psoriasis;
- muscle spasms;
- blood in urine;
- kidney problems;
- chest pain;
- oedema (a build-up of fluid in the body which causes the affected tissue to swell);
- fever;
- reduction in blood platelets which increases risk of bleeding or bruising;
- impaired healing.

Uncommon (may affect up to 1 in 100 people)

- unusual infections (which include tuberculosis and other infections) that occur when resistance to disease is lowered;
- neurological infections (including viral meningitis);
- eye infections;
- bacterial infections;
- diverticulitis (inflammation and infection of the large intestine);
- cancer, including cancer that affects the lymph system (lymphoma) and melanoma (a type of skin cancer);

- immune disorders that could affect the lungs, skin and lymph nodes (most commonly as a condition called sarcoidosis);
- vasculitis (inflammation of blood vessels);
- tremor;
- neuropathy (nerve damage);
- stroke;
- double vision;
- hearing loss, buzzing;
- sensation of heart beating irregularly such as skipped beats;
- heart problems that can cause shortness of breath or ankle swelling;
- heart attack;
- a sac in the wall of a major artery, inflammation and clot of a vein; blockage of a blood vessel;
- lung diseases causing shortness of breath (including inflammation);
- pulmonary embolism (blockage in an artery of the lung);
- pleural effusion (abnormal collection of fluid in the pleural space);
- inflammation of the pancreas which causes severe pain in the abdomen and back;
- difficulty in swallowing;
- facial oedema (swelling);
- gallbladder inflammation, gallbladder stones;
- fatty liver (build-up of fat in liver cells);
- night sweats;
- scar;
- abnormal muscle breakdown;
- systemic lupus erythematosus (an immune disorder including inflammation of skin, heart, lung, joints and other organ systems);
- sleep interruptions;
- impotence;
- inflammations.

Rare (may affect up to 1 in 1 000 people)

- leukaemia (cancer affecting the blood and bone marrow);
- severe allergic reaction with shock;
- multiple sclerosis;
- nerve disorders (such as inflammation of the optic nerve to the eye, and Guillain-Barré syndrome, a condition that may cause muscle weakness, abnormal sensations, tingling in the arms and upper body);
- heart stops pumping;
- pulmonary fibrosis (scarring of the lung);
- intestinal perforation (hole in the wall of the gut);
- hepatitis (liver inflammation);
- reactivation of hepatitis B infection;
- autoimmune hepatitis (inflammation of the liver caused by the body's own immune system);
- cutaneous vasculitis (inflammation of blood vessels in the skin);
- Stevens-Johnson syndrome (life-threatening reaction with flu-like symptoms and blistering rash);
- facial oedema (swelling) associated with allergic reactions;
- erythema multiforme (inflammatory skin rash);
- lupus-like syndrome;
- angioedema (localised swelling of the skin);
- lichenoid skin reaction (itchy reddish-purple skin rash).

Not known (frequency cannot be estimated from available data)

- hepatosplenic T-cell lymphoma (a rare blood cancer that is often fatal);
- Merkel cell carcinoma (a type of skin cancer);
- Kaposi's sarcoma, a rare cancer related to infection with human herpes virus 8. Kaposi's sarcoma most commonly appears as purple lesions on the skin;
- liver failure;
- worsening of a condition called dermatomyositis (seen as a skin rash accompanying muscle weakness).
- weight gain (for most patients, the weight gain was small)

Some side effects observed with adalimumab may not have symptoms and may only be discovered through blood tests. These include:

Very common (may affect more than 1 in 10 people)

- low blood measurements for white blood cells;
- low blood measurements for red blood cells;
- increased lipids in the blood;
- raised liver enzymes.

Common (may affect up to 1 in 10 people)

- high blood measurements for white blood cells;
- low blood measurements for platelets;
- increased uric acid in the blood;
- abnormal blood measurements for sodium;
- low blood measurements for calcium;
- low blood measurements for phosphate;
- high blood sugar;
- high blood measurements for lactate dehydrogenase;
- autoantibodies present in the blood;
- low blood potassium.

Uncommon (may affect up to 1 in 100 people)

- raised bilirubin measurement (liver blood test).

Rare (may affect up to 1 in 1 000 people)

- low blood measurements for white blood cells, red blood cells and platelet count.

Reporting of side effects

If you get any side effects, talk to your doctor or pharmacist. This includes any possible side effects not listed in this leaflet. You can also report side effects directly via [the national reporting system listed in Appendix V](#). By reporting side effects, you can help provide more information on the safety of this medicine.

5. How to store Hyrimoz

Keep this medicine out of the sight and reach of children.

Do not use this medicine after the expiry date which is stated on the label/blister/carton after EXP.

The expiry date refers to the last day of that month.

Store in a refrigerator (2°C–8°C). Do not freeze.

Keep the pre-filled syringe in the outer carton in order to protect from light.

Alternative Storage:

When needed (for example when you are travelling), Hyrimoz may be stored at room temperature (up to 25°C) for a maximum period of 21 days – be sure to protect it from light. Once removed from the refrigerator for room temperature storage, your pre-filled syringe **must be used within 21 days or discarded**, even if it is later returned to the refrigerator. You should record the date when your pre-filled syringe is first removed from the refrigerator, and the date after which it should be discarded.

Do not throw away any medicines via wastewater or household waste. Ask your pharmacist how to throw away medicines you no longer use. These measures will help protect the environment.

6. Contents of the pack and other information

What Hyrimoz contains

- The active substance is adalimumab. Each pre-filled syringe contains 40 mg of adalimumab in 0.8 ml of solution.
- The other ingredients are adipic acid, citric acid monohydrate, sodium chloride, mannitol (E 421), polysorbate 80 (E 433), hydrochloric acid (E 507), sodium hydroxide (E 524) and water for injections (see section 2 “Hyrimoz contains sodium”).

What Hyrimoz looks like and contents of the pack

Hyrimoz 40 mg solution for injection (injection) in pre-filled syringe is supplied as a 0.8 ml clear to slightly opalescent, colourless or slightly yellowish solution.

Hyrimoz is supplied in a single-use clear type I glass syringe with a stainless steel 29 gauge needle with a needle guard with finger flange, rubber needle cap (thermoplastic elastomer) and plastic plunger rod, containing 0.8 ml of solution.

Cartons contain 1 and 2 pre-filled syringes of Hyrimoz.

Multipack cartons contain 6 (3 packs of 2) pre-filled syringes of Hyrimoz.

Not all pack sizes may be marketed.

Hyrimoz is available as a pre-filled syringe and a pre-filled pen.

Marketing Authorisation Holder

Sandoz GmbH
Biochemiestr. 10
6250 Kundl
Austria

Manufacturer

Sandoz GmbH Schafteuau
Biochemiestr. 10
6336 Langkampfen
Austria

Novartis Pharmaceutical Manufacturing GmbH
Biochemiestrasse 10
6336 Langkampfen
Austria

For any information about this medicine, please contact the local representative of the Marketing Authorisation Holder:

België/Belgique/Belgien

Sandoz nv/sa
Tél/Tel: +32 2 722 97 97

България

Сандоз България КЧТ
Тел.: +359 2 970 47 47

Česká republika

Sandoz s.r.o.
Tel: +420 225 775 111

Danmark/Norge/Ísland/Sverige

Sandoz A/S
Tlf./Sími/Tel: +45 63 95 10 00

Deutschland

Hexal AG
Tel: +49 8024 908 0

Eesti

Sandoz d.d. Eesti filiaal
Tel: +372 665 2400

Ελλάδα

SANDOZ HELLAS MONOΠΡΟΣΩΠΗ Α.Ε.
Τηλ: +30 216 600 5000

España

Sandoz Farmacéutica, S.A.
Tel: +34 900 456 856

France

Sandoz SAS
Tél: +33 1 49 64 48 00

Hrvatska

Sandoz d.o.o.
Tel: +385 1 23 53 111

Ireland

Rowex Ltd.
Tel: + 353 27 50077

Italia

Sandoz S.p.A.
Tel: +39 02 96541

Lietuva

Sandoz Pharmaceuticals d.d filialas
Tel: +370 5 2636 037

Luxembourg/Luxemburg

Sandoz nv/sa (Belgique/Belgien)
Tél/Tel.: +32 2 722 97 97

Magyarország

Sandoz Hungária Kft.
Tel.: +36 1 430 2890

Malta

Sandoz Pharmaceuticals d.d.
Tel: +356 99644126

Nederland

Sandoz B.V.
Tel: +31 36 52 41 600

Österreich

Sandoz GmbH
Tel: +43 5338 2000

Polska

Sandoz Polska Sp. z o.o.
Tel.: +48 22 209 70 00

Portugal

Sandoz Farmacêutica Lda.
Tel: +351 21 000 86 00

România

Sandoz Pharmaceuticals SRL
Tel: +40 21 407 51 60

Slovenija

Sandoz farmacevtska družba d.d.
Tel: +386 1 580 29 02

Slovenská republika

Sandoz d.d. - organizačná zložka
Tel: +421 2 48 200 600

Suomi/Finland

Sandoz A/S
Puh/Tel: +358 10 6133 400

Κύπρος
SANDOZ HELLAS MONOΠΡΟΣΩΠΗ Α.Ε.
(Ελλάδα)
Τηλ: +30 216 600 5000

Latvija
Sandoz d.d. Latvia filiāle
Tel: +371 67 892 006

United Kingdom (Northern Ireland)
Sandoz GmbH
Tel: +43 5338 2000

This leaflet was last revised in

Other sources of information

Detailed information on this medicine is available on the European Medicines Agency web site:
<https://www.ema.europa.eu>.

7. Instructions for use

To help avoid possible infections and to ensure that you use the medicine correctly, it is important that you follow these instructions.

Be sure that you read, understand, and follow these Instructions for Use before injecting Hyrimoz. Your healthcare provider should show you how to prepare and inject Hyrimoz properly using the pre-filled syringe before you use it for the first time. Talk to your healthcare provider if you have any questions.

Your Hyrimoz single-use pre-filled syringe with needle guard and add-on finger flange

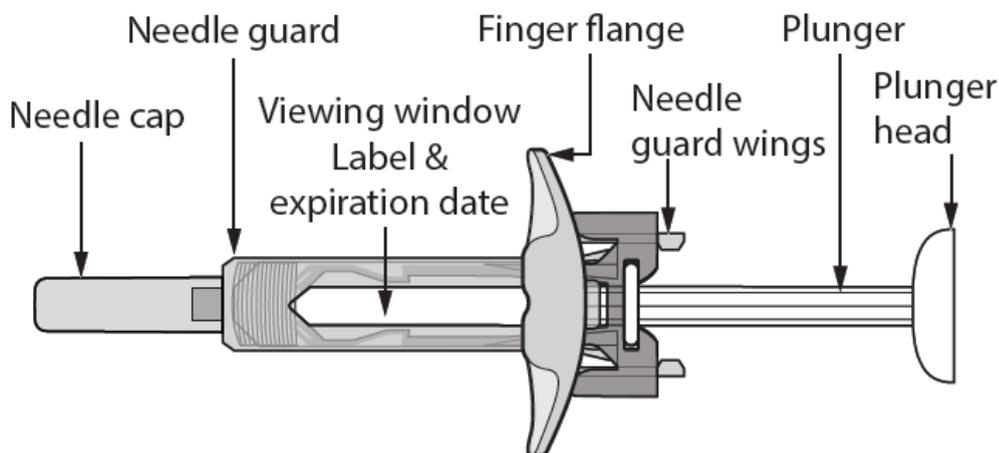

Figure A: Hyrimoz pre-filled syringe with needle guard and add-on finger flange

It is important that you:

- **do not open** the outer box until you are ready to use the syringe.
- **do not use** the syringe if the seals of the blister are broken, as it may not be safe for you to use.
- **never leave** the syringe unattended where others might tamper with it.
- if you drop your syringe, **do not use** it if it looks damaged, or if you dropped it with the needle cap removed.
- **do not remove** the needle cap until just before you give the injection.
- be careful **not to touch** the needle guard wings before use. Touching them may cause the needle guard to be activated too early. **Do not remove** the finger flange before the injection.
- inject Hyrimoz 15–30 minutes after taking it out of the refrigerator for a more comfortable injection.
- throw away the used syringe right away after use. **Do not re-use a syringe.** See “4. Disposing of used syringes” at the end of these Instructions for Use.

How should you store Hyrimoz?

- Store your outer carton of syringes in a refrigerator, between 2°C to 8°C.
- When needed (for example when you are travelling), Hyrimoz may be stored at room temperature (up to 25°C) for a maximum period of 21 days – be sure to protect it from light. Once removed from the refrigerator for room temperature storage, your pre-filled syringe **must be used within 21 days or discarded**, even if it is later returned to the refrigerator. You should record the date when your pre-filled syringe is first removed from the refrigerator, and the date after which it should be discarded.
- Keep the syringes in the original carton until ready to use to protect from light.

- Do not store the syringes in extreme heat or cold.
- Do not freeze the syringes.

Keep Hyrimoz and all medicines out of the reach of children.

What do you need for your injection?

Place the following items on a clean, flat surface.

Included in your carton is:

- Hyrimoz pre-filled syringe/s (see *Figure A*). Each syringe contains 40 mg/0.8 ml of Hyrimoz.

Not included in your carton are (see *Figure B*):

- Alcohol wipe
- Cotton ball or gauze
- Sharps disposal container

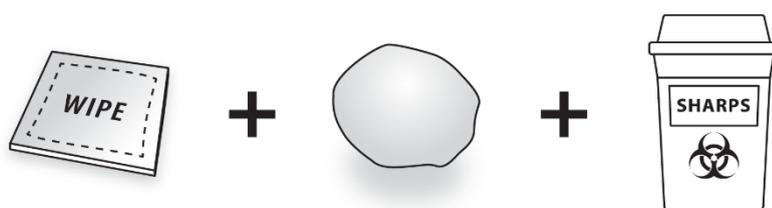

Figure B: items not included in the carton

See “4. **Disposing of used syringes**” at the end of these Instructions for Use.

Before your injection

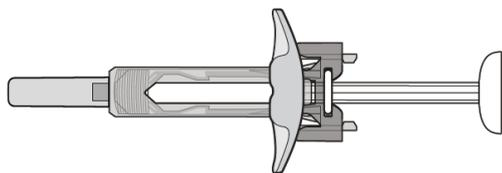

Figure C: needle guard is not activated – the syringe is ready for use

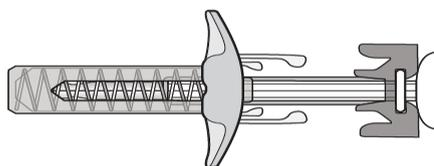

Figure D: needle guard is activated – do not use

- | | |
|--|---|
| <ul style="list-style-type: none"> ○ In this configuration the needle guard is NOT ACTIVATED. ○ The syringe is ready for use (see <i>Figure C</i>). | <ul style="list-style-type: none"> ○ In this configuration the needle guard is ACTIVATED. ○ DO NOT USE the syringe (see <i>Figure D</i>). |
|--|---|

Preparing the syringe

- For a more comfortable injection, take the blister containing the syringe out of the refrigerator and leave it unopened on your work surface for about 15 to 30 minutes so that it reaches room temperature.
- Take the syringe out of the blister.
- Look through the viewing window. The solution should be colourless or slightly yellowish as well as clear to slightly opalescent. Do not use if any particulates and/or discolorations are observed. If you are concerned with the appearance of the solution, then contact your pharmacist for assistance.
- Do not use the syringe if it is broken or the needle guard is activated. Return the syringe and the package it came in to the pharmacy.

- Look at the expiry date (EXP) on your syringe. Do not use the syringe if the expiry date has passed.

Contact your pharmacist if the syringe fails any of the above mentioned checks.

1. Choosing your injection site:

- The recommended injection site is the front of your thighs. You may also use the lower abdomen, but not the area 5 cm around your navel (belly button) (see *Figure E*).
- Choose a different site each time you give yourself an injection.
- Do not inject into areas where the skin is tender, bruised, red, scaly, or hard. Avoid areas with scars or stretch marks. If you have psoriasis, you should NOT inject directly into areas with psoriasis plaques.

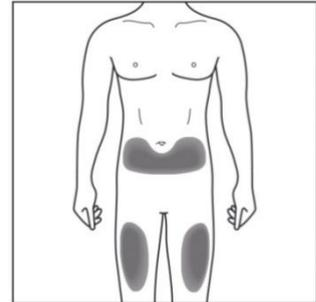

Figure E: choose your injection site

2. Cleaning your injection site:

- Wash your hands well with soap and water.
- Using a circular motion, clean the injection site with an alcohol wipe. Leave it to dry before injecting (see *Figure F*).
- Do not touch the cleaned area before injecting.

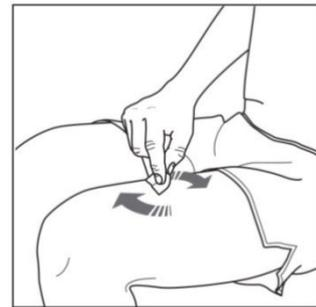

Figure F: clean your injection site

3. Giving your injection:

- Carefully pull the needle cap straight off to remove it from the syringe (see *Figure G*).
- Discard the needle cap.
- You may see a drop of liquid at the end of the needle. This is normal.

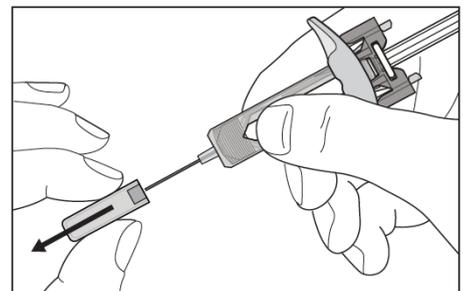

Figure G: pull the needle cap off

- Gently pinch the skin at the injection site (see *Figure H*).
- Insert the needle into your skin as shown.
- Push the needle all the way in to ensure that the medication can be fully administered

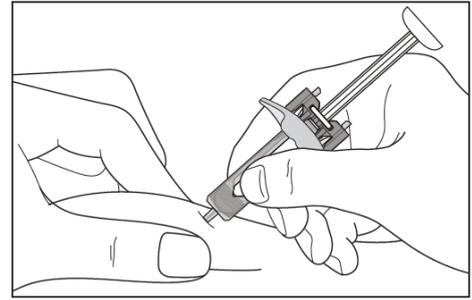

Figure H: insert the needle

- Hold the syringe as shown (see *Figure I*).
- Slowly press down on the plunger as far as it will go, so that the plunger head is completely between the needle guard wings.
- Keep the plunger pressed fully down while you hold the syringe in place for 5 seconds.

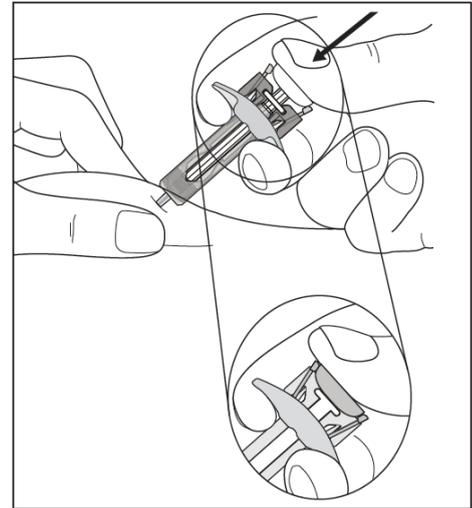

Figure I: hold the syringe

- **Keep the plunger fully pressed down** while you carefully lift the needle straight out from the injection site and let go of your skin (see *Figure J*).

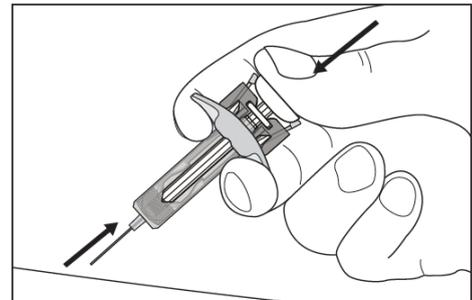

Figure J: lift the needle straight out

- Slowly release the plunger and allow the needle safety guard to automatically cover the exposed needle (see *Figure K*).
- There may be a small amount of blood at the injection site. You can press a cotton ball or gauze onto the injection site and hold it for 10 seconds. Do not rub the injection site. You may cover the injection site with a small adhesive bandage, if needed.

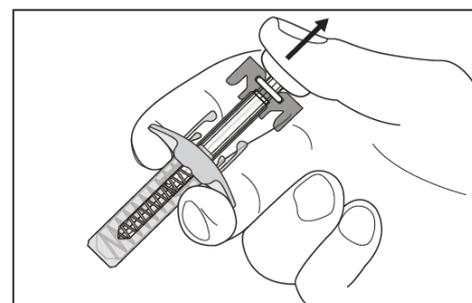
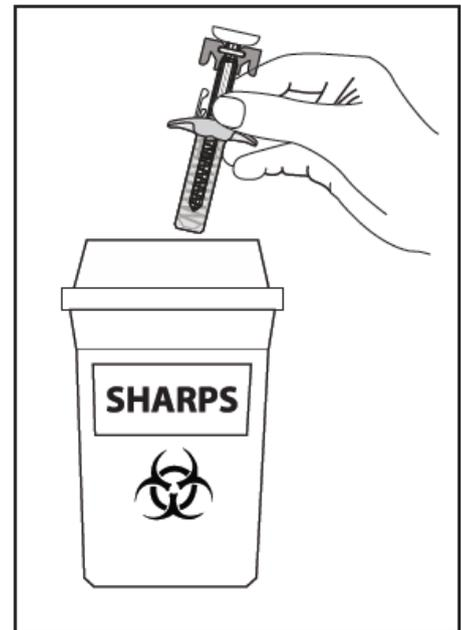

Figure K: slowly release the plunger

4. Disposing of used syringes:

- Dispose of the used syringe in a sharps container (closable, puncture-resistant container). For the safety and health of you and others, needles and used syringes must never be re-used.
- Do not throw away any medicines via wastewater or household waste. Ask your doctor or pharmacist how to throw away medicines you no longer use. These measures will help protect the environment. Any unused product or waste material should be disposed of in accordance with local requirements.



If you have any questions, please talk to a doctor, pharmacist or nurse who is familiar with Hyrimoz.

Package leaflet: Information for the patient

Hyrimoz 40 mg solution for injection in pre-filled pen adalimumab 40 mg/0.8 ml

Read all of this leaflet carefully before you start using this medicine because it contains important information for you.

- Keep this leaflet. You may need to read it again.
- Your doctor will also give you a **Patient Reminder Card**, which contains important safety information that you need to be aware of before you are given Hyrimoz and during treatment with Hyrimoz. Keep this **Patient Reminder Card** with you during your treatment and for 4 months after your (or your child's) last injection of Hyrimoz.
- If you have any further questions, please ask your doctor or pharmacist.
- This medicine has been prescribed for you only. Do not pass it on to others. It may harm them, even if their signs of illness are the same as yours.
- If you get any side effects, talk to your doctor or pharmacist. This includes any possible side effects not listed in this leaflet. See section 4.

What is in this leaflet

1. What Hyrimoz is and what it is used for
2. What you need to know before you use Hyrimoz
3. How to use Hyrimoz
4. Possible side effects
5. How to store Hyrimoz
6. Contents of the pack and other information
7. Instructions for use

1. What Hyrimoz is and what it is used for

Hyrimoz contains the active substance adalimumab, a medicine that acts on your body's immune (defence) system.

Hyrimoz is intended for the treatment of the following inflammatory diseases:

- rheumatoid arthritis,
- polyarticular juvenile idiopathic arthritis,
- enthesitis-related arthritis,
- ankylosing spondylitis,
- axial spondyloarthritis without radiographic evidence of ankylosing spondylitis,
- psoriatic arthritis,
- psoriasis,
- hidradenitis suppurativa,
- Crohn's disease,
- ulcerative colitis and
- non-infectious uveitis.

The active substance in Hyrimoz, adalimumab, is a monoclonal antibody. Monoclonal antibodies are proteins that attach to a specific target in the body.

The target of adalimumab is another protein called tumour necrosis factor (TNF α), which is present at increased levels in the inflammatory diseases listed above. By attaching to TNF α , Hyrimoz blocks its action and reduces the inflammation in these diseases.

Rheumatoid arthritis

Rheumatoid arthritis is an inflammatory disease of the joints.

Hyrimoz is used to treat rheumatoid arthritis in adults. If you have moderate to severe active rheumatoid arthritis, you may first be given other disease-modifying medicines, such as methotrexate. If these medicines do not work well enough, you will be given Hyrimoz to treat your rheumatoid arthritis.

Hyrimoz can also be used to treat severe, active and progressive rheumatoid arthritis without previous methotrexate treatment.

Hyrimoz can slow down the damage to the cartilage and bone of the joints caused by the disease and improve physical function.

Usually, Hyrimoz is used with methotrexate. If your doctor considers that methotrexate is inappropriate, Hyrimoz can be given alone.

Polyarticular juvenile idiopathic arthritis and enthesitis-related arthritis

Polyarticular juvenile idiopathic arthritis and enthesitis-related arthritis are inflammatory diseases of the joints that usually first appear in childhood.

Hyrimoz is used to treat polyarticular juvenile idiopathic arthritis in children and adolescents aged 2 to 17 years and enthesitis-related arthritis in children and adolescents aged 6 to 17 years. Patients may first be given other disease-modifying medicines, such as methotrexate. If these medicines do not work well enough, patients will be given Hyrimoz to treat their polyarticular juvenile idiopathic arthritis or enthesitis-related arthritis.

Ankylosing spondylitis and axial spondyloarthritis without radiographic evidence of ankylosing spondylitis

Ankylosing spondylitis and axial spondyloarthritis without radiographic evidence of ankylosing spondylitis, are inflammatory diseases of the spine.

Hyrimoz is used in adults to treat these conditions. If you have ankylosing spondylitis or axial spondyloarthritis without radiographic evidence of ankylosing spondylitis, you will first be given other medicines. If these medicines do not work well enough, you will be given Hyrimoz to reduce the signs and symptoms of your disease.

Plaque psoriasis in adults and children

Plaque psoriasis is an inflammatory skin condition that causes red, flaky, crusty patches of skin covered with silvery scales. Plaque psoriasis can also affect the nails, causing them to crumble, become thickened and lift away from the nail bed which can be painful. Psoriasis is believed to be caused by a problem with the body's immune system that leads to an increased production of skin cells.

Hyrimoz is used to treat moderate to severe plaque psoriasis in adults. Hyrimoz is also used to treat severe plaque psoriasis in children and adolescents aged 4 to 17 years for whom medicines applied to the skin and treatment with UV light have either not worked very well or are not suitable.

Psoriatic arthritis

Psoriatic arthritis is an inflammatory disease of the joints associated with psoriasis.

Hyrimoz is used to treat psoriatic arthritis in adults. Hyrimoz can slow down the damage to the

cartilage and bone of the joints caused by the disease and improve physical function.

Hidradenitis suppurativa in adults and adolescents

Hidradenitis suppurativa (sometimes called acne inversa) is a long-term and often painful inflammatory skin disease. Symptoms may include tender nodules (lumps) and abscesses (boils) that may leak pus.

It most commonly affects specific areas of the skin, such as under the breasts, the armpits, inner thighs, groin and buttocks. Scarring may also occur in affected areas.

Hyrimoz is used to treat hidradenitis suppurativa in adults and adolescents from 12 years of age. Hyrimoz can reduce the number of nodules and abscesses you have, and the pain that is often associated with the disease. You may first be given other medicines. If these medicines do not work well enough, you will be given Hyrimoz.

Crohn's disease in adults and children

Crohn's disease is an inflammatory disease of the gut.

Hyrimoz is used to treat Crohn's disease in adults and children aged 6 to 17 years. If you have Crohn's disease you will first be given other medicines. If you do not respond well enough to these medicines, you will be given Hyrimoz to reduce the signs and symptoms of your Crohn's disease.

Ulcerative colitis in adults and children

Ulcerative colitis is an inflammatory disease of the large intestine.

Hyrimoz is used to treat moderate to severe ulcerative colitis in adults children aged 6 to 17 years. If you have ulcerative colitis you may first be given other medicines. If these medicines do not work well enough, you will be given Hyrimoz to reduce the signs and symptoms of your disease.

Non-infectious uveitis in adults and children

Non-infectious uveitis is an inflammatory disease affecting certain parts of the eye. The inflammation leads to a decrease of vision and/or the presence of floaters in the eye (black dots or wispy lines that move across the field of vision). Hyrimoz works by reducing this inflammation.

Hyrimoz is used to treat

- adults with non-infectious uveitis with inflammation affecting the back of the eye.
- children from 2 years of age with chronic non-infectious uveitis with inflammation affecting the front of the eye.

2. What you need to know before you use Hyrimoz

Do not use Hyrimoz

- if you are allergic to adalimumab or any of the other ingredients of this medicine (listed in section 6).
- if you have a severe infection, including tuberculosis, sepsis (blood poisoning) or other opportunistic infections (unusual infections associated with a weakened immune system). It is important that you tell your doctor if you have symptoms of infections, e.g. fever, wounds, feeling tired, dental problems (see "Warnings and precautions").
- if you have moderate or severe heart failure. It is important to tell your doctor if you have had or have a serious heart condition (see "Warnings and precautions").

Warnings and precautions

Talk to your doctor or pharmacist before using Hyrimoz.

Allergic reaction

- If you have allergic reactions with symptoms such as chest tightness, wheezing, dizziness, swelling or rash, do not inject more Hyrimoz and contact your doctor immediately, since in rare cases, these reactions can be life-threatening.

Infection

- If you have an infection, including long-term or localised infection (for example leg ulcer), consult your doctor before starting Hyrimoz. If you are unsure, contact your doctor.
- You might get infections more easily while you are receiving Hyrimoz treatment. This risk may increase if your lung function is reduced. These infections may be more serious and include tuberculosis, infections caused by viruses, fungi, parasites or bacteria, or other unusual infectious organisms and sepsis (blood poisoning).
- In rare cases, these infections may be life-threatening. It is important to tell your doctor if you get symptoms such as fever, wounds, feeling tired or dental problems. Your doctor may recommend temporarily stopping Hyrimoz.

Tuberculosis (TB)

- As cases of tuberculosis have been reported in patients treated with adalimumab, your doctor will check you for signs and symptoms of tuberculosis before starting Hyrimoz. This will include a thorough medical evaluation including your medical history and screening tests (for example chest X-ray and a tuberculin test). The conduct and results of these tests should be recorded on your Patient Reminder Card. It is very important that you tell your doctor if you have ever had tuberculosis, or if you have been in close contact with someone who has had tuberculosis. Tuberculosis can develop during therapy even if you have had preventative treatment for tuberculosis. If symptoms of tuberculosis (persistent cough, weight loss, listlessness, mild fever), or any other infection appear during or after therapy tell your doctor immediately.

Travel/recurrent infection

- Tell your doctor if you have lived or travelled in regions where fungal infections such as histoplasmosis, coccidioidomycosis or blastomycosis are common.
- Tell your doctor if you have a history of recurrent infections or other conditions that increase the risk of infections.

Hepatitis B virus

- Tell your doctor if you are a carrier of the hepatitis B virus (HBV), if you have active HBV infection or if you think you might be at risk of contracting HBV. Your doctor should test you for HBV. Adalimumab can reactivate HBV infection in people who carry this virus. In some rare cases, especially if you are taking other medicines that suppress the immune system, reactivation of HBV infection can be life-threatening.

Age over 65 years

- If you are over 65 years you may be more susceptible to infections while taking Hyrimoz. You and your doctor should pay special attention to signs of infection while you are being treated

with Hyrimoz. It is important to tell your doctor if you get symptoms of infections, such as fever, wounds, feeling tired or dental problems.

Surgery or dental procedures

- If you are about to have surgery or dental procedures tell your doctor that you are taking Hyrimoz. Your doctor may recommend temporarily stopping Hyrimoz.

Demyelinating disease

- If you have or develop demyelinating disease (a disease that affects the insulating layer around the nerves, such as multiple sclerosis), your doctor will decide if you should receive or continue to receive Hyrimoz. Tell your doctor immediately if you get symptoms like changes in your vision, weakness in your arms or legs or numbness or tingling in any part of your body.

Vaccine

- Certain vaccines contain living but weakened forms of disease-causing bacteria or viruses and should not be given during treatment with Hyrimoz in case they cause infections. Check with your doctor before you receive any vaccines. It is recommended that, if possible, children be given all the scheduled vaccinations for their age before they start treatment with Hyrimoz.

If you receive Hyrimoz while you are pregnant, your baby may be at higher risk for getting an infection for up to about five months after the last dose you received during pregnancy. It is important that you tell your baby's doctors and other health care professionals about your Hyrimoz use during your pregnancy so they can decide when your baby should receive any vaccine.

Heart failure

- It is important to tell your doctor if you have had or have a serious heart condition. If you have mild heart failure and you are being treated with Hyrimoz, your heart failure status must be closely monitored by your doctor. If you develop new or worsening symptoms of heart failure (e.g. shortness of breath, or swelling of your feet), you must contact your doctor immediately.

Fever, bruising, bleeding or looking pale

- In some patients the body may fail to produce enough of the blood cells that fight off infections or help you to stop bleeding. If you develop a fever that does not go away, or you bruise or bleed very easily or look very pale, call your doctor right away. Your doctor may decide to stop treatment.

Cancer

- There have been very rare cases of certain kinds of cancer in children and adults taking adalimumab or other TNF α blockers. People with more serious rheumatoid arthritis who have had the disease for a long time may have a higher than average risk of getting lymphoma and leukaemia (cancers that affect blood cells and bone marrow). If you take Hyrimoz the risk of getting lymphoma, leukaemia, or other cancers may increase. On rare occasions, a specific and severe type of lymphoma has been observed in patients taking adalimumab. Some of those patients were also treated with the medicines azathioprine or mercaptopurine. Tell your doctor if you are taking azathioprine or mercaptopurine with Hyrimoz.
- In addition cases of non-melanoma skin cancer have been observed in patients taking adalimumab. If new areas of damaged skin appear during or after treatment or if existing marks or areas of damage change appearance, tell your doctor.
- There have been cases of cancers, other than lymphoma, in patients with a specific type of lung disease called chronic obstructive pulmonary disease (COPD) treated with another

TNF α blocker. If you have COPD, or are a heavy smoker, you should discuss with your doctor whether treatment with a TNF α blocker is appropriate for you.

Autoimmune diseases

- On rare occasions, treatment with Hyrimoz could result in lupus-like syndrome. Contact your doctor, if symptoms such as persistent unexplained rash, fever, joint pain or tiredness occur.

Children and adolescents

- Vaccinations: if possible, children should be up to date with all vaccinations before using Hyrimoz.
- Do not give Hyrimoz to children with polyarticular juvenile idiopathic arthritis below the age of 2 years.

Other medicines and Hyrimoz

Tell your doctor or pharmacist if you are taking, have recently taken or might take any other medicines.

Hyrimoz can be taken together with methotrexate or certain disease-modifying anti-rheumatic agents (sulfasalazine, hydroxychloroquine, leflunomide and injectable gold preparations), corticosteroids or pain medications including non-steroidal anti-inflammatory drugs (NSAIDs).

You should not take Hyrimoz with medicines containing the active substances anakinra or abatacept due to increased risk of serious infection. The combination of adalimumab as well as other TNF-antagonists and anakinra or abatacept is not recommended based upon the possible increased risk for infections, including serious infections and other potential pharmacological interactions. If you have questions, please ask your doctor.

Pregnancy and breast-feeding

- You should consider the use of adequate contraception to prevent pregnancy and continue its use for at least 5 months after the last Hyrimoz treatment.
- If you are pregnant, think you may be pregnant or are planning to have a baby, ask your doctor for advice before taking this medicine.
- Hyrimoz should only be used during a pregnancy if needed.
- According to a pregnancy study, there was no higher risk of birth defects when the mother had received adalimumab during pregnancy compared with mothers with the same disease who did not receive adalimumab.
- Hyrimoz can be used during breast-feeding.
- If you receive Hyrimoz during your pregnancy, your baby may have a higher risk for getting an infection.
- It is important that you tell your baby's doctors and other health care professionals about your Hyrimoz use during your pregnancy before the baby receives any vaccine (for more information on vaccines see the "Warnings and precautions" section).

Driving and using machines

Hyrimoz may have a minor influence on your ability to drive, cycle or use machines. Room spinning sensation (vertigo) and vision disturbances may occur after taking Hyrimoz.

Hyrimoz contains sodium

This medicine contains less than 1 mmol of sodium (23 mg) per 0.8 ml dose, that is to say essentially 'sodium-free'.

3. How to use Hyrimoz

Always use this medicine exactly as your doctor or pharmacist has told you. Check with your doctor or pharmacist if you are not sure.

Hyrimoz is available as a 40 mg pen as well as 20 mg and 40 mg pre-filled syringes for patients to administer a full 20 mg or 40 mg dose.

Rheumatoid arthritis, psoriatic arthritis, ankylosing spondylitis or axial spondyloarthritis without radiographic evidence of ankylosing spondylitis		
Age and body weight	How much and how often to take?	Notes
Adults	40 mg every other week as a single dose	In rheumatoid arthritis, methotrexate is continued while using Hyrimoz. If your doctor determines that methotrexate is inappropriate, Hyrimoz can be given alone. If you have rheumatoid arthritis and you do not receive methotrexate with your Hyrimoz therapy, your doctor may decide to give 40 mg Hyrimoz every week or 80 mg every other week.

Polyarticular juvenile idiopathic arthritis		
Age and body weight	How much and how often to take?	Notes
Children, adolescents and adults from 2 years of age weighing 30 kg or more	40 mg every other week	Not applicable
Children, adolescents from 2 years of age weighing 10 kg to less than 30 kg	20 mg every other week	Not applicable

Enthesitis-related arthritis		
Age and body weight	How much and how often to take?	Notes
Children, adolescents and adults from 6 years of age weighing 30 kg or more	40 mg every other week	Not applicable
Children and adolescents from 6 years of age weighing 15 kg to less than 30 kg	20 mg every other week	Not applicable

Psoriasis		
Age and body weight	How much and how often to take?	Notes
Adults	First dose of 80 mg (as two 40 mg injections in one day), followed by 40 mg given every other week starting one week after the first dose.	You should continue to inject Hyrimoz for as long as your doctor has told you. If this dose does not work well enough, your doctor may increase the dose to 40 mg every week or 80 mg every other week.

Plaque psoriasis		
Age and body weight	How much and how often to take?	Notes
Children and adolescents from 4 to 17 years of age weighing 30 kg or more	First dose of 40 mg, followed by 40 mg one week later. Thereafter, the usual dose is 40 mg every other week.	Not applicable
Children and adolescents from 4 to 17 years of age weighing 15 kg to less than 30 kg	First dose of 20 mg, followed by 20 mg one week later. Thereafter, the usual dose is 20 mg every other week.	Not applicable

Hidradenitis suppurativa		
Age and body weight	How much and how often to take?	Notes
Adults	First dose of 160 mg (as four 40 mg injections in one day or two 40 mg injections per day for two consecutive days), followed by an 80 mg dose (as two 40 mg injections on the same day) two weeks later. After two further weeks, continue with a dose of 40 mg every week or 80 mg every other week, as prescribed by your doctor.	It is recommended that you use an antiseptic wash daily on the affected areas.
Adolescents from 12 to 17 years of age weighing 30 kg or more	First dose of 80 mg (as two 40 mg injections in one day), followed by 40 mg every other week starting one week later.	If this dose does not work well enough, your doctor may increase the dose to 40 mg every week or 80 mg every other week. It is recommended that you use an antiseptic wash daily on the affected areas.

Crohn's disease		
Age and body weight	How much and how often to take?	Notes
Adults	<p>First dose of 80 mg (as two 40 mg injections in one day), followed by 40 mg every other week starting two weeks later.</p> <p>If a faster response is required your doctor may prescribe a first dose of 160 mg (as four 40 mg injections in one day or two 40 mg injections per day for two consecutive days), followed by 80 mg (as two 40 mg injections in one day) two weeks later.</p> <p>Thereafter the usual dose is 40 mg every other week.</p>	If this dose does not work well enough, your doctor may increase the dose to 40 mg every week or 80 mg every other week.

Paediatric Crohn's disease		
Age and body weight	How much and how often to take?	Notes
Children and adolescent from 6 to 17 years of age weighing 40 kg or more	<p>First dose of 80 mg (as two 40 mg injections in one day), followed by 40 mg every other week starting two weeks later.</p> <p>If a faster response is required your doctor may prescribe a first dose of 160 mg (as four 40 mg injections in one day or two 40 mg injections per day for two consecutive days), followed by 80 mg (as two 40 mg injections in one day) two weeks later.</p> <p>Thereafter the usual dose is 40 mg every other week.</p>	If this dose does not work well enough, your child's doctor may increase the dose to 40 mg every week or 80 mg every other week.
Children and adolescents from 6 to 17 years of age weighing less than 40 kg	<p>First dose of 40 mg, followed by 20 mg every other week starting two weeks later.</p> <p>If a faster response is required, your doctor may prescribe a first dose of 80 mg (as two 40 mg injections in one day), followed by 40 mg two weeks later.</p> <p>Thereafter the usual dose is 20 mg every other week.</p>	If this dose does not work well enough, your child's doctor may increase the dose frequency to 20 mg every week.

Ulcerative colitis		
Age and body weight	How much and how often to take?	Notes
Adults	<p>First dose is 160 mg (as four 40 mg injections in one day or as two 40 mg injections per day for two consecutive days), followed by 80 mg (as two 40 mg injections in one day) two weeks later.</p> <p>Thereafter, the usual dose is 40 mg every other week.</p>	If this dose does not work well enough, your doctor may increase the dose to 40 mg every week or 80 mg every other week.

Paediatric ulcerative colitis		
Age and body weight	How much and how often to take?	Notes
Children and adolescents from 6 years of age weighing 40 kg or more	<p>First dose is 160 mg (as four 40 mg injections in one day or two 40 mg injections per day for two consecutive days) initially, followed by 80 mg (as two 40 mg injections in one day) two weeks later.</p> <p>Thereafter the usual dose is 80 mg every other week (as two 40 mg injections in one day).</p>	Patients who turn 18 years of age while on 80 mg every other week, should continue their prescribed dose.
Children and adolescents from 6 years of age weighing less than 40 kg	<p>First dose is 80 mg (as two 40 mg injections in one day) initially followed by 40 mg (as one 40 mg injection) two weeks later.</p> <p>Thereafter, the usual dose is 40 mg every other week.</p>	Patients who turn 18 years of age while on 40 mg every other week, should continue their prescribed dose.

Non-infectious uveitis		
Age and body weight	How much and how often to take?	Notes
Adults	First dose of 80 mg (as two 40 mg injections), followed by 40 mg every other week starting one week after the first dose.	<p>In non-infectious uveitis, corticosteroids or other medicines that influence the immune system may be continued while using Hyrimoz. Hyrimoz can also be given alone.</p> <p>You should continue to inject Hyrimoz for as long as your doctor has told you.</p>
Children and adolescents from 2 years of age weighing 30 kg or more	40 mg every other week with methotrexate.	Your doctor may also prescribe a first dose of 80 mg which may be administered

		one week prior to the start of the usual dose.
Children and adolescents from 2 years of age weighing less than 30 kg	20 mg every other week with methotrexate.	Your doctor may also prescribe a first dose of 40 mg which may be administered one week prior to the start of the usual dose.

Method and route of administration

Hyrimoz is administered by injection under the skin (by subcutaneous injection).

Detailed instructions on how to inject Hyrimoz are provided in section 7, “Instructions for use”.

If you use more Hyrimoz than you should

If you accidentally inject Hyrimoz more frequently than you should, call your doctor or pharmacist and explain that you have taken more than required. Always take the outer carton of medicine with you, even if it is empty.

If you forget to use Hyrimoz

If you forget to give yourself an injection, you should inject the next dose of Hyrimoz as soon as you remember. Then take your next dose as you would have on your originally scheduled day, had you not forgotten a dose.

If you stop using Hyrimoz

The decision to stop using Hyrimoz should be discussed with your doctor. Your symptoms may return upon stopping treatment.

If you have any further questions on the use of this medicine, ask your doctor or pharmacist.

4. Possible side effects

Like all medicines, this medicine can cause side effects, although not everybody gets them. Most side effects are mild to moderate. However, some may be serious and require treatment. Side effects may occur up to 4 months or more after the last Hyrimoz injection.

Seek medical attention urgently, if you notice any of the following signs of allergic reaction or heart failure:

- severe rash, hives;
- swollen face, hands, feet;
- trouble breathing, swallowing;
- shortness of breath with exertion or upon lying down or swelling of the feet.

Tell your doctor as soon as possible, if you notice any of the following:

- signs and symptoms of infection such as fever, feeling sick, wounds, dental problems, burning on urination, feeling weak or tired or coughing;
- symptoms of nerve problems such as tingling, numbness, double vision or arm or leg weakness;
- signs of skin cancer such as a bump or open sore that doesn't heal;
- signs and symptoms suggestive of blood disorders such as persistent fever, bruising, bleeding, paleness.

The following side effects have been observed with adalimumab:

Very common (may affect more than 1 in 10 people)

- injection site reactions (including pain, swelling, redness or itching);
- respiratory tract infections (including cold, runny nose, sinus infection, pneumonia);
- headache;
- abdominal (belly) pain;
- nausea and vomiting;
- rash;
- pain in the muscles.

Common (may affect up to 1 in 10 people)

- serious infections (including blood poisoning and influenza);
- intestinal infections (including gastroenteritis);
- skin infections (including cellulitis and shingles);
- ear infections;
- mouth infections (including tooth infections and cold sores);
- reproductive tract infections;
- urinary tract infection;
- fungal infections;
- joint infections;
- benign tumours;
- skin cancer;
- allergic reactions (including seasonal allergy);
- dehydration;
- mood swings (including depression);
- anxiety;
- difficulty sleeping;
- sensation disorders such as tingling, prickling or numbness;
- migraine;
- symptoms of nerve root compression (including low back pain and leg pain);
- vision disturbances;
- eye inflammation;
- inflammation of the eye lid and eye swelling;
- vertigo (sensation of room spinning);
- sensation of heart beating rapidly;
- high blood pressure;
- flushing;
- haematoma (a solid swelling with clotted blood);
- cough;
- asthma;
- shortness of breath;
- gastrointestinal bleeding;
- dyspepsia (indigestion, bloating, heart burn);
- acid reflux disease;
- sicca syndrome (including dry eyes and dry mouth);
- itching;
- itchy rash;
- bruising;
- inflammation of the skin (such as eczema);
- breaking of finger nails and toe nails;
- increased sweating;

- hair loss;
- new onset or worsening of psoriasis;
- muscle spasms;
- blood in urine;
- kidney problems;
- chest pain;
- oedema (a build-up of fluid in the body which causes the affected tissue to swell);
- fever;
- reduction in blood platelets which increases risk of bleeding or bruising;
- impaired healing.

Uncommon (may affect up to 1 in 100 people)

- unusual infections (which include tuberculosis and other infections) that occur when resistance to disease is lowered;
- neurological infections (including viral meningitis);
- eye infections;
- bacterial infections;
- diverticulitis (inflammation and infection of the large intestine);
- cancer, including cancer that affects the lymph system (lymphoma) and melanoma (a type of skin cancer);
- immune disorders that could affect the lungs, skin and lymph nodes (most commonly as a condition called sarcoidosis);
- vasculitis (inflammation of blood vessels);
- tremor;
- neuropathy (nerve damage);
- stroke;
- double vision;
- hearing loss, buzzing;
- sensation of heart beating irregularly such as skipped beats;
- heart problems that can cause shortness of breath or ankle swelling;
- heart attack;
- a sac in the wall of a major artery, inflammation and clot of a vein; blockage of a blood vessel;
- lung diseases causing shortness of breath (including inflammation);
- pulmonary embolism (blockage in an artery of the lung);
- pleural effusion (abnormal collection of fluid in the pleural space);
- inflammation of the pancreas which causes severe pain in the abdomen and back;
- difficulty in swallowing;
- facial oedema (swelling);
- gallbladder inflammation, gallbladder stones;
- fatty liver (build-up of fat in liver cells);
- night sweats;
- scar;
- abnormal muscle breakdown;
- systemic lupus erythematosus (an immune disorder including inflammation of skin, heart, lung, joints and other organ systems);
- sleep interruptions;
- impotence;
- inflammations.

Rare (may affect up to 1 in 1 000 people)

- leukaemia (cancer affecting the blood and bone marrow);
- severe allergic reaction with shock;

- multiple sclerosis;
- nerve disorders (such as inflammation of the optic nerve to the eye, and Guillain-Barré syndrome, a condition that may cause muscle weakness, abnormal sensations, tingling in the arms and upper body);
- heart stops pumping;
- pulmonary fibrosis (scarring of the lung);
- intestinal perforation (hole in the wall of the gut);
- hepatitis (liver inflammation);
- reactivation of hepatitis B infection;
- autoimmune hepatitis (inflammation of the liver caused by the body's own immune system);
- cutaneous vasculitis (inflammation of blood vessels in the skin);
- Stevens-Johnson syndrome (life-threatening reaction with flu-like symptoms and blistering rash);
- facial oedema (swelling) associated with allergic reactions;
- erythema multiforme (inflammatory skin rash);
- lupus-like syndrome;
- angioedema (localised swelling of the skin);
- lichenoid skin reaction (itchy reddish-purple skin rash).

Not known (frequency cannot be estimated from available data)

- hepatosplenic T-cell lymphoma (a rare blood cancer that is often fatal);
- Merkel cell carcinoma (a type of skin cancer);
- Kaposi's sarcoma, a rare cancer related to infection with human herpes virus 8. Kaposi's sarcoma most commonly appears as purple lesions on the skin;
- liver failure;
- worsening of a condition called dermatomyositis (seen as a skin rash accompanying muscle weakness).
- weight gain (for most patients, the weight gain was small)

Some side effects observed with adalimumab may not have symptoms and may only be discovered through blood tests. These include:

Very common (may affect more than 1 in 10 people)

- low blood measurements for white blood cells;
- low blood measurements for red blood cells;
- increased lipids in the blood;
- raised liver enzymes.

Common (may affect up to 1 in 10 people)

- high blood measurements for white blood cells;
- low blood measurements for platelets;
- increased uric acid in the blood;
- abnormal blood measurements for sodium;
- low blood measurements for calcium;
- low blood measurements for phosphate;
- high blood sugar;
- high blood measurements for lactate dehydrogenase;
- autoantibodies present in the blood;
- low blood potassium.

Uncommon (may affect up to 1 in 100 people)

- raised bilirubin measurement (liver blood test).

Rare (may affect up to 1 in 1 000 people)

- low blood measurements for white blood cells, red blood cells and platelet count.

Reporting of side effects

If you get any side effects, talk to your doctor or pharmacist. This includes any possible side effects not listed in this leaflet. You can also report side effects directly via [the national reporting system](#) listed in [Appendix V](#). By reporting side effects, you can help provide more information on the safety of this medicine.

5. How to store Hyrimoz

Keep this medicine out of the sight and reach of children.

Do not use this medicine after the expiry date which is stated on the label/blister/carton after EXP. The expiry date refers to the last day of that month.

Store in a refrigerator (2°C–8°C). Do not freeze.

Keep the pre-filled pen in the outer carton in order to protect from light.

Alternative Storage:

When needed (for example when you are travelling), Hyrimoz may be stored at room temperature (up to 25°C) for a maximum period of 21 days – be sure to protect it from light. Once removed from the refrigerator for room temperature storage, your pre-filled pen **must be used within 21 days or discarded**, even if it is later returned to the refrigerator. You should record the date when your pre-filled pen is first removed from the refrigerator, and the date after which it should be discarded.

Do not throw away any medicines via wastewater or household waste. Ask your pharmacist how to throw away medicines you no longer use. These measures will help protect the environment.

6. Contents of the pack and other information

What Hyrimoz contains

- The active substance is adalimumab. Each pre-filled pen contains 40 mg of adalimumab in 0.8 ml of solution.
- The other ingredients are adipic acid, citric acid monohydrate, sodium chloride, mannitol (E 421), polysorbate 80 (E 433), hydrochloric acid (E 507), sodium hydroxide (E 524) and water for injections (see section 2 “Hyrimoz contains sodium”).

What Hyrimoz looks like and contents of the pack

Hyrimoz 40 mg solution for injection (injection) in pre-filled pen is supplied as a 0.8 ml clear to slightly opalescent, colourless or slightly yellowish solution.

Hyrimoz is supplied in a single-use pre-filled syringe assembled into a triangular-shaped pen with transparent window and label. The syringe inside the pen is made of type I glass with a stainless steel

29 gauge needle and an inner rubber needle cap (thermoplastic elastomer), containing 0.8 ml of solution.

Cartons contain 1 and 2 pre-filled pens of Hyrimoz.
Multipack cartons contain 6 (3 packs of 2) pre-filled pens of Hyrimoz.

Not all pack sizes may be marketed.
Hyrimoz is available as a pre-filled syringe and a pre-filled pen.

Marketing Authorisation Holder

Sandoz GmbH
Biochemiestr. 10
6250 Kundl
Austria

Manufacturer

Sandoz GmbH Schafteuau
Biochemiestr. 10
6336 Langkampfen
Austria

Novartis Pharmaceutical Manufacturing GmbH
Biochemiestrasse 10
6336 Langkampfen
Austria

For any information about this medicine, please contact the local representative of the Marketing Authorisation Holder:

België/Belgique/Belgien

Sandoz nv/sa
Tél/Tel: +32 2 722 97 97

Lietuva

Sandoz Pharmaceuticals d.d filialas
Tel: +370 5 2636 037

България

Сандоз България КЧТ
Тел.: +359 2 970 47 47

Luxembourg/Luxemburg

Sandoz nv/sa (Belgique/Belgien)
Tél/Tel.: +32 2 722 97 97

Česká republika

Sandoz s.r.o.
Tel: +420 225 775 111

Magyarország

Sandoz Hungária Kft.
Tel.: +36 1 430 2890

Danmark/Norge/Ísland/Sverige

Sandoz A/S
Tlf./Sími/Tel: +45 63 95 10 00

Malta

Sandoz Pharmaceuticals d.d.
Tel: +356 99644126

Deutschland

Hexal AG
Tel: +49 8024 908 0

Nederland

Sandoz B.V.
Tel: +31 36 52 41 600

Eesti

Sandoz d.d. Eesti filiaal
Tel: +372 665 2400

Ελλάδα

SANDOZ HELLAS MONOΠΡΟΣΩΠΗ Α.Ε.
Τηλ: +30 216 600 5000

España

Sandoz Farmacéutica, S.A.
Tel: +34 900 456 856

France

Sandoz SAS
Tél: +33 1 49 64 48 00

Hrvatska

Sandoz d.o.o.
Tel: +385 1 23 53 111

Ireland

Rowex Ltd.
Tel: + 353 27 50077

Italia

Sandoz S.p.A.
Tel: +39 02 96541

Κύπρος

SANDOZ HELLAS MONOΠΡΟΣΩΠΗ Α.Ε.
(Ελλάδα)
Τηλ: +30 216 600 5000

Latvija

Sandoz d.d. Latvia filiāle
Tel: +371 67 892 006

Österreich

Sandoz GmbH
Tel: +43 5338 2000

Polska

Sandoz Polska Sp. z o.o.
Tel.: +48 22 209 70 00

Portugal

Sandoz Farmacêutica Lda.
Tel: +351 21 000 86 00

România

Sandoz Pharmaceuticals SRL
Tel: +40 21 407 51 60

Slovenija

Sandoz farmacevtska družba d.d.
Tel: +386 1 580 29 02

Slovenská republika

Sandoz d.d. - organizačná zložka
Tel: +421 2 48 200 600

Suomi/Finland

Sandoz A/S
Puh/Tel: +358 10 6133 400

United Kingdom (Northern Ireland)

Sandoz GmbH
Tel: +43 5338 2000

This leaflet was last revised in

Other sources of information

Detailed information on this medicine is available on the European Medicines Agency web site:
<https://www.ema.europa.eu>.

7. Instructions for use

To help avoid possible infections and to ensure that you use the medicine correctly, it is important that you follow these instructions.

Be sure that you read, understand, and follow these Instructions for use before injecting Hyrimoz. Your healthcare provider should show you how to prepare and inject Hyrimoz properly using the pre-filled pen before you use it for the first time. Talk to your healthcare provider if you have any questions.

Your Hyrimoz single-use pre-filled pen

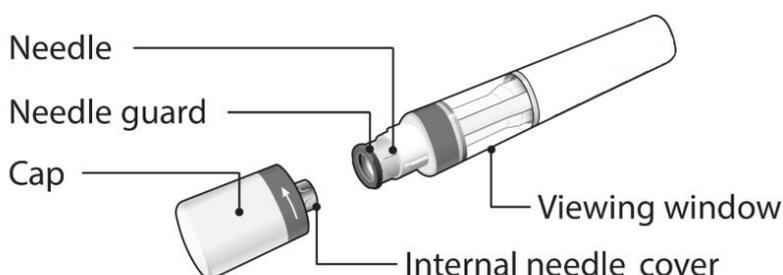

Figure A: Hyrimoz pen parts

In *Figure A*, the pen is shown with the cap removed. **Do not** remove the cap until you are ready to inject.

It is important that you:

- **do not open** the outer box until you are ready to use the pen.
- **do not use** the pen if either the seal on the outer carton or the safety seal on the pen is broken.
- **never leave** the pen unattended where others might tamper with it.
- if you drop your pen, **do not use** it if it looks damaged, or if you dropped it with the cap removed.
- inject Hyrimoz 15–30 minutes after taking it out of the refrigerator for a more comfortable injection.
- throw away the used pen right away after use. **Do not re-use the pen.** See “8. Disposing of used pens” at the end of this Instructions for Use.

How should you store your pen?

- Store your pen within the carton in a refrigerator, between 2°C to 8°C.
- When needed (for example when you are travelling), Hyrimoz may be stored at room temperature (up to 25°C) for a maximum period of 21 days – be sure to protect it from light. Once removed from the refrigerator for room temperature storage, your pre-filled pen **must be used within 21 days or discarded**, even if it is later returned to the refrigerator. You should record the date when your pre-filled pen is first removed from the refrigerator, and the date after which it should be discarded.
- Keep your pen in the original carton until ready to use to protect from light.
- Do not store your pen in extreme heat or cold.
- Do not freeze your pen.

Keep Hyrimoz and all medicines out of the reach of children.

What do you need for your injection?

Place the following items on a clean, flat surface.

Included in your carton is:

- Hyrimoz pre-filled pen/s (see *Figure A*). Each pen contains 40 mg/0.8 ml of Hyrimoz.

Not included in your carton are (see *Figure B*):

- Alcohol wipe
- Cotton ball or gauze
- Sharps disposal container

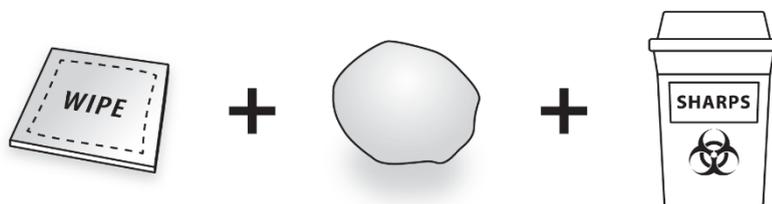

Figure B: items not included in the carton

See “8. **Disposing of used pens**” at the end of these Instructions for Use.

Before your injection

Preparing the pen

- For a more comfortable injection, take your pen out of the refrigerator 15 to 30 minutes before injecting Hyrimoz to allow it to reach room temperature.
- Look through the viewing window. The solution should be colourless or slightly yellowish as well as clear to slightly opalescent. **Do not use** if any particulates and/or discolorations are observed. If you are concerned with the appearance of the solution, then contact your pharmacist for assistance.

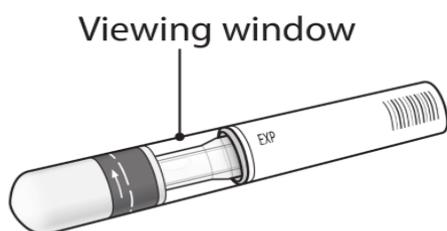

Figure C: Safety Checks before injection

- Look at the expiry date (EXP) on your pen. Do not use your pen if the expiry date has passed.
- Do not use if the safety seal has been broken.

Contact your pharmacist if the pen fails any of the above mentioned checks.

1. Choosing your injection site:

- The recommended injection site is the front of your thighs. You may also use the lower abdomen, but not the area 5 cm around your navel (belly button) (see *Figure D*).
- Choose a different site each time you give yourself an injection.
- Do not inject into areas where the skin is tender, bruised, red, scaly, or hard. Avoid areas with scars or stretch marks. If you have psoriasis, you should NOT inject directly into areas with psoriasis plaques.

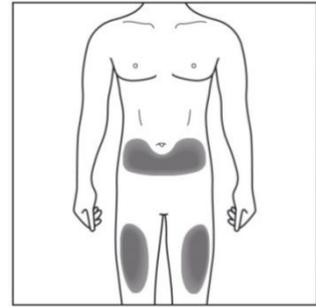

Figure D: choose your injection site

2. Cleaning your injection site:

- Wash your hands well with soap and water.
- Using a circular motion, clean the injection site with an alcohol wipe. Leave it to dry before injecting (see *Figure E*).
- Do not touch the cleaned area again before injecting.

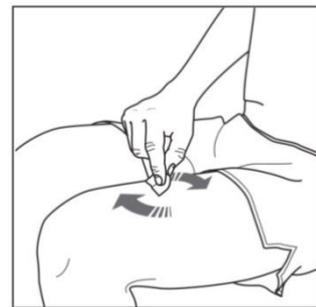

Figure E: clean your injection site

3. Removing the cap of the pen:

- Only remove the cap when you are ready to use the pen.
- Twist off the cap in the direction of the arrows (see *Figure F*).
- Once removed, throw away the cap. **Do not try to re-attach the cap.**
- Use your pen within 5 minutes of removing the cap.
- You may see a few drops of liquid come out of the needle. This is normal.

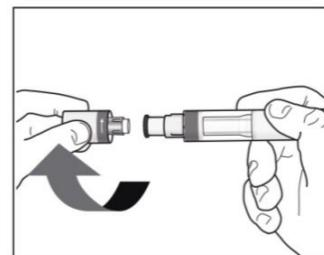

Figure F: remove the cap

4. Holding the pen:

- Hold your pen at 90 degrees to the cleaned injection site (see *Figure G*).

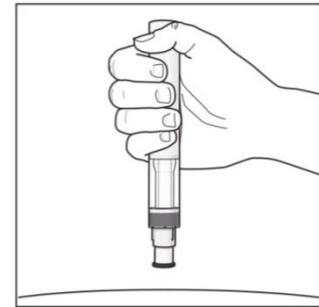
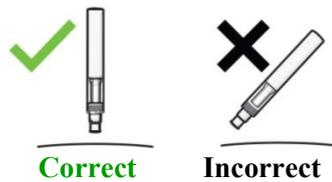

Figure G: hold your pen

Your injection

You must read this before injecting

During the injection you will hear **2 loud clicks**:

- The **1st click** indicates that the injection has **started**.
- Several seconds later a **2nd click** will indicate that the injection is **almost** finished.

You must keep holding your pen firmly against your skin until you see a **green indicator** fill the window and stop moving.

5. Starting your injection:

- Press your pen firmly against the skin to start the injection (see *Figure H*).
- The **1st click** indicates the injection has started.
- **Keep holding** your pen firmly against your skin.
- The **green indicator** shows the progress of the injection.

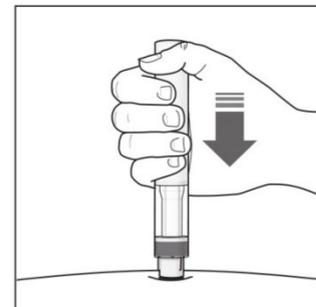

Figure H: start your injection

6. Completing your injection:

- Listen for the **2nd click**. This indicates the injection is **almost** complete.
- Check the **green indicator** fills the window and has stopped moving (see *Figure I*).
- The pen can now be removed.

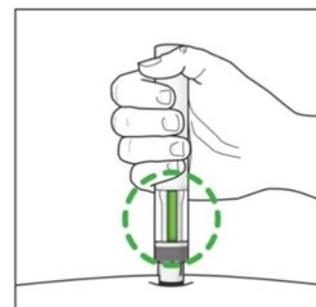

Figure I: complete your injection

After your injection

7. Check the green indicator fills the window (see *Figure J*):

- This means the medicine has been delivered. Contact your doctor if the green indicator is not visible.
- There may be a small amount of blood at the injection site. You can press a cotton ball or gauze over the injection site and hold it for 10 seconds. Do not rub the injection site. You may cover the injection site with a small adhesive bandage, if needed.

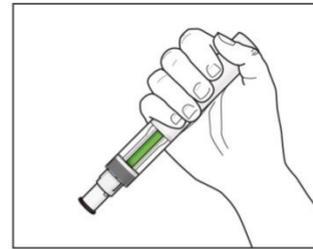
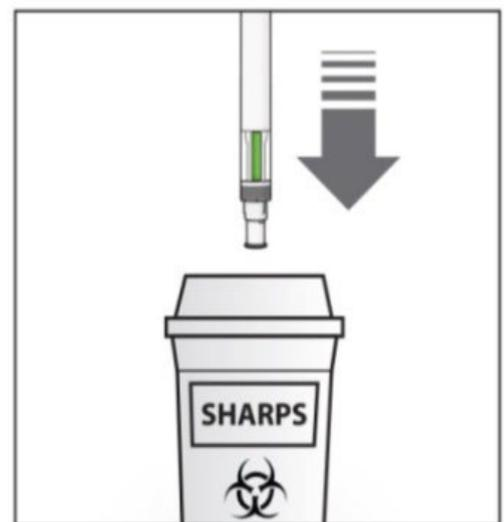

Figure J: check the green indicator

8. Disposing of used pens:

- Dispose of the used pens in a sharps container (closable, puncture-resistant container). For the safety and health of you and others, the pens must never be re-used.
- Do not throw away any medicines via wastewater or household waste. Ask your doctor or pharmacist how to throw away medicines you no longer use. These measures will help protect the environment. Any unused product or waste material should be disposed of in accordance with local requirements.



If you have any questions, please talk to a doctor, pharmacist or nurse who is familiar with Hyrimoz.

Package leaflet: Information for the patient

Hyrimoz 40 mg solution for injection in pre-filled syringe adalimumab 40 mg/0.4 ml

Read all of this leaflet carefully before you start using this medicine because it contains important information for you.

- Keep this leaflet. You may need to read it again.
- Your doctor will also give you a **Patient Reminder Card**, which contains important safety information that you need to be aware of before you are given Hyrimoz and during treatment with Hyrimoz. Keep this **Patient Reminder Card** with you during your treatment and for 4 months after your (or your child's) last injection of Hyrimoz.
- If you have any further questions, please ask your doctor or pharmacist.
- This medicine has been prescribed for you only. Do not pass it on to others. It may harm them, even if their signs of illness are the same as yours.
- If you get any side effects, talk to your doctor or pharmacist. This includes any possible side effects not listed in this leaflet. See section 4.

What is in this leaflet

1. What Hyrimoz is and what it is used for
2. What you need to know before you use Hyrimoz
3. How to use Hyrimoz
4. Possible side effects
5. How to store Hyrimoz
6. Contents of the pack and other information
7. Instructions for use

1. What Hyrimoz is and what it is used for

Hyrimoz contains the active substance adalimumab, a medicine that acts on your body's immune (defence) system.

Hyrimoz is intended for the treatment of the following inflammatory diseases:

- rheumatoid arthritis,
- polyarticular juvenile idiopathic arthritis,
- enthesitis-related arthritis,
- ankylosing spondylitis,
- axial spondyloarthritis without radiographic evidence of ankylosing spondylitis,
- psoriatic arthritis,
- plaque psoriasis,
- hidradenitis suppurativa,
- Crohn's disease,
- ulcerative colitis,
- non-infectious uveitis.

The active substance in Hyrimoz, adalimumab, is a monoclonal antibody. Monoclonal antibodies are proteins that attach to a specific target in the body.

The target of adalimumab is another protein called tumour necrosis factor (TNF α), which is present at increased levels in the inflammatory diseases listed above. By attaching to TNF α , Hyrimoz blocks its action and reduces the inflammation in these diseases.

Rheumatoid arthritis

Rheumatoid arthritis is an inflammatory disease of the joints.

Hyrimoz is used to treat rheumatoid arthritis in adults. If you have moderate to severe active rheumatoid arthritis, you may first be given other disease-modifying medicines, such as methotrexate. If these medicines do not work well enough, you will be given Hyrimoz to treat your rheumatoid arthritis.

Hyrimoz can also be used to treat severe, active and progressive rheumatoid arthritis without previous methotrexate treatment.

Hyrimoz can slow down the damage to the cartilage and bone of the joints caused by the disease and improve physical function.

Usually, Hyrimoz is used with methotrexate. If your doctor considers that methotrexate is inappropriate, Hyrimoz can be given alone.

Polyarticular juvenile idiopathic arthritis

Polyarticular juvenile idiopathic arthritis is an inflammatory disease of the joints.

Hyrimoz is used to treat polyarticular juvenile idiopathic arthritis in children and adolescents aged 2 to 17 years. Patients may first be given other disease-modifying medicines, such as methotrexate. If these medicines do not work well enough, patients will be given Hyrimoz.

Enthesitis-related arthritis

Enthesitis-related arthritis is an inflammatory disease of the joints and the places where tendons join the bone. Hyrimoz is used to treat enthesitis-related arthritis in patients from 6 years of age.

Patients may first be given other disease-modifying medicines, such as methotrexate.

If these medicines do not work well enough, patients will be given Hyrimoz.

Ankylosing spondylitis and axial spondyloarthritis without radiographic evidence of ankylosing spondylitis

Ankylosing spondylitis and axial spondyloarthritis without radiographic evidence of ankylosing spondylitis, are inflammatory diseases of the spine.

Hyrimoz is used in adults to treat these conditions. If you have ankylosing spondylitis or axial spondyloarthritis without radiographic evidence of ankylosing spondylitis, you will first be given other medicines. If these medicines do not work well enough, you will be given Hyrimoz to reduce the signs and symptoms of your disease.

Plaque psoriasis in adults and children

Plaque psoriasis is an inflammatory skin condition that causes red, flaky, crusty patches of skin covered with silvery scales. Plaque psoriasis can also affect the nails, causing them to crumble, become thickened and lift away from the nail bed which can be painful. Psoriasis is believed to be caused by a problem with the body's immune system that leads to an increased production of skin cells.

Hyrimoz is used to treat moderate to severe plaque psoriasis in adults. Hyrimoz is also used to treat severe plaque psoriasis in children and adolescents aged 4 to 17 years for whom medicines applied to the skin and treatment with UV light have either not worked very well or are not suitable.

Psoriatic arthritis

Psoriatic arthritis is an inflammatory disease of the joints associated with psoriasis.

Hyrimoz is used to treat psoriatic arthritis in adults. Hyrimoz can slow down the damage to the cartilage and bone of the joints caused by the disease and improve physical function.

Hidradenitis suppurativa in adults and adolescents

Hidradenitis suppurativa (sometimes called acne inversa) is a long-term and often painful inflammatory skin disease. Symptoms may include tender nodules (lumps) and abscesses (boils) that may leak pus.

It most commonly affects specific areas of the skin, such as under the breasts, the armpits, inner thighs, groin and buttocks. Scarring may also occur in affected areas.

Hyrimoz is used to treat

- moderate to severe hidradenitis suppurativa in adults and
- moderate to severe hidradenitis suppurativa in adolescents aged 12 to 17 years.

Hyrimoz can reduce the number of nodules and abscesses you have, and the pain that is often associated with the disease. You may first be given other medicines. If these medicines do not work well enough, you will be given Hyrimoz.

Crohn's disease in adults and children

Crohn's disease is an inflammatory disease of the gut.

Hyrimoz is used to treat

- moderate to severe Crohn's disease in adults and
- moderate to severe Crohn's disease in children and adolescents aged 6 to 17 years.

If you have Crohn's disease you will first be given other medicines. If you do not respond well enough to these medicines, you will be given Hyrimoz to reduce the signs and symptoms of your Crohn's disease.

Ulcerative colitis in adults and children

Ulcerative colitis is an inflammatory disease of the large intestine.

Hyrimoz is used to treat

- moderate to severe ulcerative colitis in adults and
- moderate to severe ulcerative colitis in children and adolescents aged 6 to 17 years.

If you have ulcerative colitis you may first be given other medicines. If these medicines do not work well enough, you will be given Hyrimoz to reduce the signs and symptoms of your ulcerative colitis.

Non-infectious uveitis in adults and children

Non-infectious uveitis is an inflammatory disease affecting certain parts of the eye. The inflammation leads to a decrease of vision and/or the presence of floaters in the eye (black dots or wispy lines that move across the field of vision). Hyrimoz works by reducing this inflammation.

Hyrimoz is used to treat

- adults with non-infectious uveitis with inflammation affecting the back of the eye.
- children from 2 years of age with chronic non-infectious uveitis with inflammation affecting the front of the eye.

You may first be given other medicines. If you do not respond well enough to these medicines, you will be given Hyrimoz.

2. What you need to know before you use Hyrimoz

Do not use Hyrimoz

- if you are allergic to adalimumab or any of the other ingredients of this medicine (listed in section 6).
- if you have a severe infection, including tuberculosis, sepsis (blood poisoning) or other opportunistic infections (unusual infections associated with a weakened immune system). It is important that you tell your doctor if you have symptoms of infections, e.g. fever, wounds, feeling tired, dental problems (see “Warnings and precautions”).
- if you have moderate or severe heart failure. It is important to tell your doctor if you have had or have a serious heart condition (see “Warnings and precautions”).

Warnings and precautions

Talk to your doctor or pharmacist before using Hyrimoz.

Allergic reaction

- If you have allergic reactions with symptoms such as chest tightness, wheezing, dizziness, swelling or rash, do not inject more Hyrimoz and contact your doctor immediately, since in rare cases, these reactions can be life-threatening.

Infections

- If you have an infection, including long-term or localised infection (for example leg ulcer), consult your doctor before starting Hyrimoz. If you are unsure, contact your doctor.
- You might get infections more easily while you are receiving Hyrimoz treatment. This risk may increase if your lung function is reduced. These infections may be more serious and include tuberculosis, infections caused by viruses, fungi, parasites or bacteria, or other unusual infectious organisms and sepsis (blood poisoning).
- In rare cases, these infections may be life-threatening. It is important to tell your doctor if you get symptoms such as fever, wounds, feeling tired or dental problems. Your doctor may recommend temporarily stopping Hyrimoz.

Tuberculosis (TB)

- As cases of tuberculosis have been reported in patients treated with adalimumab, your doctor will check you for signs and symptoms of tuberculosis before starting Hyrimoz. This will include a thorough medical evaluation including your medical history and screening tests (for example chest X-ray and a tuberculin test). The conduct and results of these tests should be recorded on your **Patient Reminder Card**. It is very important that you tell your doctor if you have ever had tuberculosis, or if you have been in close contact with someone who has had tuberculosis. Tuberculosis can develop during therapy even if you have had preventative treatment for tuberculosis. If symptoms of tuberculosis (persistent cough, weight loss, lack of energy, mild fever), or any other infection appear during or after therapy tell your doctor immediately.

Travel/recurrent infection

- Tell your doctor if you have lived or travelled in regions where fungal infections such as histoplasmosis, coccidioidomycosis or blastomycosis are very common.
- Tell your doctor if you have a history of recurrent infections or other conditions that increase the risk of infections.

Hepatitis B virus

- Tell your doctor if you are a carrier of the hepatitis B virus (HBV), if you have active HBV infection or if you think you might be at risk of getting HBV. Your doctor should test you for HBV. Adalimumab can reactivate HBV infection in people who carry this virus. In some rare cases, especially if you are taking other medicines that suppress the immune system, reactivation of HBV infection can be life-threatening.

Age over 65 years

- If you are over 65 years you may be more susceptible to infections while taking Hyrimoz. You and your doctor should pay special attention to signs of infection while you are being treated with Hyrimoz. It is important to tell your doctor if you get symptoms of infections, such as fever, wounds, feeling tired or dental problems.

Surgery or dental procedures

- If you are about to have surgery or dental procedures tell your doctor that you are taking Hyrimoz. Your doctor may recommend temporarily stopping Hyrimoz.

Demyelinating disease

- If you have or develop demyelinating disease (a disease that affects the insulating layer around the nerves, such as multiple sclerosis), your doctor will decide if you should receive or continue to receive Hyrimoz. Tell your doctor immediately if you get symptoms like changes in your vision, weakness in your arms or legs or numbness or tingling in any part of your body.

Vaccine

- Certain vaccines contain living but weakened forms of disease-causing bacteria or viruses and should not be given during treatment with Hyrimoz in case they cause infections. Check with your doctor before you receive any vaccines. It is recommended that, if possible, children be given all the scheduled vaccinations for their age before they start treatment with Hyrimoz. If you receive Hyrimoz while you are pregnant, your baby may be at higher risk for getting an infection for up to about five months after the last dose you received during pregnancy. It is important that you tell your baby's doctors and other health care professionals about your Hyrimoz use during your pregnancy so they can decide when your baby should receive any vaccine.

Heart failure

- It is important to tell your doctor if you have had or have a serious heart condition. If you have mild heart failure and you are being treated with Hyrimoz, your heart failure status must be closely monitored by your doctor. If you develop new or worsening symptoms of heart failure (e.g. shortness of breath, or swelling of your feet), you must contact your doctor immediately.

Fever, bruising, bleeding or looking pale

- In some patients the body may fail to produce enough of the blood cells that fight off infections or help you to stop bleeding. If you develop a fever that does not go away, or you bruise or bleed very easily or look very pale, call your doctor right away. Your doctor may decide to stop treatment.

Cancer

- There have been very rare cases of certain kinds of cancer in children and adults taking adalimumab or other TNF α blockers. People with more serious rheumatoid arthritis who have had the disease for a long time may have a higher than average risk of getting lymphoma and leukaemia (cancers that affect blood cells and bone marrow). If you take Hyrimoz the risk of getting lymphoma, leukaemia, or other cancers may increase. On rare occasions, a specific and severe type of lymphoma has been observed in patients taking adalimumab. Some of those patients were also treated with the medicines azathioprine or mercaptopurine. Tell your doctor if you are taking azathioprine or mercaptopurine with Hyrimoz.
- In addition cases of non-melanoma skin cancer have been observed in patients taking adalimumab. If new areas of damaged skin appear during or after treatment or if existing marks or areas of damage change appearance, tell your doctor.
- There have been cases of cancers, other than lymphoma, in patients with a specific type of lung disease called chronic obstructive pulmonary disease (COPD) treated with another TNF α blocker. If you have COPD, or are a heavy smoker, you should discuss with your doctor whether treatment with a TNF α blocker is appropriate for you.

Autoimmune diseases

- On rare occasions, treatment with Hyrimoz could result in lupus-like syndrome. Contact your doctor, if symptoms such as persistent unexplained rash, fever, joint pain or tiredness occur.

Children and adolescents

- Vaccinations: if possible, children should be up to date with all vaccinations before using Hyrimoz.

Other medicines and Hyrimoz

Tell your doctor or pharmacist if you are taking, have recently taken or might take any other medicines.

Hyrimoz can be taken together with methotrexate or certain disease-modifying anti-rheumatic agents (sulfasalazine, hydroxychloroquine, leflunomide and injectable gold preparations), corticosteroids or pain medications including non-steroidal anti-inflammatory drugs (NSAIDs).

You should not take Hyrimoz with medicines containing the active substances anakinra or abatacept due to increased risk of serious infection. The combination of adalimumab as well as other TNF-antagonists and anakinra or abatacept is not recommended based upon the possible increased risk for infections, including serious infections and other potential pharmacological interactions. If you have questions, please ask your doctor.

Pregnancy and breast-feeding

- You should consider the use of adequate contraception to prevent pregnancy and continue its use for at least 5 months after the last Hyrimoz treatment.

- If you are pregnant, think you may be pregnant or are planning to have a baby, ask your doctor for advice before taking this medicine.
- Hyrimoz should only be used during a pregnancy if needed.
- According to a pregnancy study, there was no higher risk of birth defects when the mother had received adalimumab during pregnancy compared with mothers with the same disease who did not receive adalimumab.
- Hyrimoz can be used during breast-feeding.
- If you receive Hyrimoz during your pregnancy, your baby may have a higher risk for getting an infection.
- It is important that you tell your baby’s doctors and other health care professionals about your Hyrimoz use during your pregnancy before the baby receives any vaccine (for more information on vaccines see the “Warnings and precautions” section).

Driving and using machines

Hyrimoz may have a minor influence on your ability to drive, cycle or use machines. Room spinning sensation (vertigo) and vision disturbances may occur after taking Hyrimoz.

Hyrimoz contains sodium

This medicine contains less than 1 mmol of sodium (23 mg) per 0.4 ml dose, that is to say essentially ‘sodium-free’.

3. How to use Hyrimoz

Always use this medicine exactly as your doctor or pharmacist has told you. Check with your doctor or pharmacist if you are not sure.

The recommended doses for Hyrimoz in each of the approved uses are shown in the following table. Your doctor may prescribe another strength of Hyrimoz if you need a different dose.

Rheumatoid arthritis, psoriatic arthritis, ankylosing spondylitis or axial spondyloarthritis without radiographic evidence of ankylosing spondylitis		
Age or body weight	How much and how often to take?	Notes
Adults	40 mg every other week as a single dose	<p>In rheumatoid arthritis, methotrexate is continued while using Hyrimoz. If your doctor determines that methotrexate is inappropriate, Hyrimoz can be given alone.</p> <p>If you have rheumatoid arthritis and you do not receive methotrexate with your Hyrimoz therapy, your doctor may decide to give 40 mg Hyrimoz every week or 80 mg every other week.</p>

Polyarticular juvenile idiopathic arthritis		
Age or body weight	How much and how often to take?	Notes
Children, adolescents and adults from 2 years of age weighing 30 kg or more	40 mg every other week	Not applicable
Children, adolescents from 2 years of age weighing 10 kg to less than 30 kg	20 mg every other week	Not applicable

Enthesitis-related arthritis		
Age or body weight	How much and how often to take?	Notes
Children, adolescents and adults from 6 years of age weighing 30 kg or more	40 mg every other week	Not applicable
Children and adolescents from 6 years of age weighing 15 kg to less than 30 kg	20 mg every other week	Not applicable

Plaque Psoriasis		
Age or body weight	How much and how often to take?	Notes
Adults	First dose of 80 mg (as two 40 mg injections in one day), followed by 40 mg given every other week starting one week after the first dose.	You should continue to inject Hyrimoz for as long as your doctor has told you. If this dose does not work well enough, your doctor may increase the dose to 40 mg every week or 80 mg every other week.

Paediatric plaque psoriasis		
Age or body weight	How much and how often to take?	Notes
Children and adolescents from 4 to 17 years of age weighing 30 kg or more	First dose of 40 mg, followed by 40 mg one week later. Thereafter, the usual dose is 40 mg every other week.	Not applicable
Children and adolescents from 4 to 17 years of age weighing 15 kg to less than 30 kg	First dose of 20 mg, followed by 20 mg one week later. Thereafter, the usual dose is 20 mg every other week.	Not applicable

Hidradenitis suppurativa		
Age or body weight	How much and how often to take?	Notes
Adults	<p>First dose of 160 mg (as four 40 mg injections in one day or two 40 mg injections per day for two consecutive days), followed by an 80 mg dose (as two 40 mg injections on the same day) two weeks later.</p> <p>After two further weeks, continue with a dose of 40 mg every week or 80 mg every other week, as prescribed by your doctor.</p>	It is recommended that you use an antiseptic wash daily on the affected areas.
Adolescents from 12 to 17 years of age weighing 30 kg or more	First dose of 80 mg (as two 40 mg injections in one day), followed by 40 mg every other week starting one week later.	<p>If this dose does not work well enough, your doctor may increase the dose to 40 mg every week or 80 mg every other week.</p> <p>It is recommended that you use an antiseptic wash daily on the affected areas.</p>

Crohn's disease		
Age or body weight	How much and how often to take?	Notes
Adults	<p>First dose of 80 mg (as two 40 mg injections in one day), followed by 40 mg every other week starting two weeks later.</p> <p>If a faster response is required your doctor may prescribe a first dose of 160 mg (as four 40 mg injections in one day or two 40 mg injections per day for two consecutive days), followed by 80 mg (as two 40 mg injections in one day) two weeks later.</p> <p>Thereafter the usual dose is 40 mg every other week.</p>	If this dose does not work well enough, your doctor may increase the dose to 40 mg every week or 80 mg every other week.

Paediatric Crohn's disease		
Age or body weight	How much and how often to take?	Notes
Children and adolescent from 6 to 17 years of age weighing 40 kg or more	<p>First dose of 80 mg (as two 40 mg injections in one day), followed by 40 mg every other week starting two weeks later.</p> <p>If a faster response is required your doctor may prescribe a first dose of 160 mg (as four 40 mg injections in one day or two 40 mg injections per day for two consecutive days), followed by 80 mg (as two 40 mg injections in one day) two weeks later.</p> <p>Thereafter the usual dose is 40 mg every other week.</p>	If this dose does not work well enough, your child's doctor may increase the dose to 40 mg every week or 80 mg every other week.
Children and adolescents from 6 to 17 years of age weighing less than 40 kg	<p>First dose of 40 mg, followed by 20 mg every other week starting two weeks later.</p> <p>If a faster response is required, your doctor may prescribe a first dose of 80 mg (as two 40 mg injections in one day), followed by 40 mg two weeks later.</p> <p>Thereafter the usual dose is 20 mg every other week.</p>	If this dose does not work well enough, your child's doctor may increase the dose frequency to 20 mg every week.

Ulcerative colitis		
Age or body weight	How much and how often to take?	Notes
Adults	<p>First dose is 160 mg (as four 40 mg injections in one day or as two 40 mg injections per day for two consecutive days), followed by 80 mg (as two 40 mg injections in one day) two weeks later.</p> <p>Thereafter, the usual dose is 40 mg every other week.</p>	If this dose does not work well enough, your doctor may increase the dose to 40 mg every week or 80 mg every other week.

Paediatric ulcerative colitis		
Age or body weight	How much and how often to take?	Notes
Children and adolescents from 6 years of age weighing 40 kg or more	<p>First dose is 160 mg (as four 40 mg injections in one day or two 40 mg injections per day for two consecutive days) initially, followed by 80 mg (as</p>	Patients who turn 18 years of age while on 80 mg every other week, should continue their prescribed dose.

	two 40 mg injections in one day) two weeks later. Thereafter the usual dose is 80 mg every other week.	
Children and adolescents from 6 years of age weighing less than 40 kg	First dose is 80 mg (as two 40 mg injections in one day) initially followed by 40 mg (as one 40 mg injection) two weeks later. Thereafter, the usual dose is 40 mg every other week.	Patients who turn 18 years of age while on 40 mg every other week, should continue their prescribed dose.

Non-infectious uveitis		
Age or body weight	How much and how often to take?	Notes
Adults	First dose of 80 mg (as two 40 mg injections), followed by 40 mg every other week starting one week after the first dose.	In non-infectious uveitis, corticosteroids or other medicines that influence the immune system may be continued while using Hyrimoz. Hyrimoz can also be given alone. You should continue to inject Hyrimoz for as long as your doctor has told you.
Children and adolescents from 2 years of age weighing 30 kg or more	40 mg every other week.	Your doctor may also prescribe a first dose of 80 mg which may be administered one week prior to the start of the usual dose of 40 mg every other week. Hyrimoz is recommended for the use in combination with methotrexate.
Children and adolescents from 2 years of age weighing less than 30 kg	20 mg every other week.	Your doctor may also prescribe a first dose of 40 mg which may be administered one week prior to the start of the usual dose of 20 mg every other week. Hyrimoz is recommended for the use in combination with methotrexate.

Method and route of administration

Hyrimoz is administered by injection under the skin (by subcutaneous injection).

Detailed instructions on how to inject Hyrimoz are provided in section 7, “**Instructions for use**”.

If you use more Hyrimoz than you should

If you accidentally inject Hyrimoz more frequently than you should, call your doctor or pharmacist and explain that you have taken more than required. Always take the outer carton of medicine with you, even if it is empty.

If you forget to use Hyrimoz

If you forget to give yourself an injection, you should inject the next dose of Hyrimoz as soon as you remember. Then take your next dose as you would have on your originally scheduled day, had you not forgotten a dose.

If you stop using Hyrimoz

The decision to stop using Hyrimoz should be discussed with your doctor. Your symptoms may return upon stopping treatment.

If you have any further questions on the use of this medicine, ask your doctor or pharmacist.

4. Possible side effects

Like all medicines, this medicine can cause side effects, although not everybody gets them. Most side effects are mild to moderate. However, some may be serious and require treatment. Side effects may occur up to 4 months or more after the last Hyrimoz injection.

Seek medical attention urgently, if you notice any of the following signs of allergic reaction or heart failure:

- severe rash, hives;
- swollen face, hands, feet;
- trouble breathing, swallowing;
- shortness of breath with physical activity or upon lying down or swelling of the feet.

Tell your doctor as soon as possible, if you notice any of the following:

- signs and symptoms of infection such as fever, feeling sick, wounds, dental problems, burning on urination, feeling weak or tired or coughing;
- symptoms of nerve problems such as tingling, numbness, double vision or arm or leg weakness;
- signs of skin cancer such as a bump or open sore that doesn't heal;
- signs and symptoms suggestive of blood disorders such as persistent fever, bruising, bleeding, paleness.

The following side effects have been observed with adalimumab:

Very common (may affect more than 1 in 10 people)

- injection site reactions (including pain, swelling, redness or itching);
- respiratory tract infections (including cold, runny nose, sinus infection, pneumonia);
- headache;
- abdominal (belly) pain;
- nausea and vomiting;
- rash;
- pain in the muscles.

Common (may affect up to 1 in 10 people)

- serious infections (including blood poisoning and influenza);
- intestinal infections (including gastroenteritis);
- skin infections (including cellulitis and shingles);
- ear infections;
- mouth infections (including tooth infections and cold sores);
- reproductive tract infections;
- urinary tract infection;
- fungal infections;
- joint infections;
- benign tumours;
- skin cancer;
- allergic reactions (including seasonal allergy);
- dehydration;
- mood swings (including depression);
- anxiety;
- difficulty sleeping;
- sensation disorders such as tingling, prickling or numbness;
- migraine;
- symptoms of nerve root compression (including low back pain and leg pain);
- vision disturbances;
- eye inflammation;
- inflammation of the eye lid and eye swelling;
- vertigo (sensation of room spinning);
- sensation of heart beating rapidly;
- high blood pressure;
- flushing;
- haematoma (a solid swelling with clotted blood);
- cough;
- asthma;
- shortness of breath;
- gastrointestinal bleeding;
- dyspepsia (indigestion, bloating, heart burn);
- acid reflux disease;
- sicca syndrome (including dry eyes and dry mouth);
- itching;
- itchy rash;
- bruising;
- inflammation of the skin (such as eczema);
- breaking of finger nails and toe nails;
- increased sweating;
- hair loss;
- new onset or worsening of psoriasis;
- muscle spasms;
- blood in urine;
- kidney problems;
- chest pain;
- oedema (a build-up of fluid in the body which causes the affected tissue to swell);
- fever;
- reduction in blood platelets which increases risk of bleeding or bruising;
- impaired healing.

Uncommon (may affect up to 1 in 100 people)

- unusual infections (which include tuberculosis and other infections) that occur when resistance to disease is lowered;
- neurological infections (including viral meningitis);
- eye infections;
- bacterial infections;
- diverticulitis (inflammation and infection of the large intestine);
- cancer, including cancer that affects the lymph system (lymphoma) and melanoma (a type of skin cancer);
- immune disorders that could affect the lungs, skin and lymph nodes (most commonly as a condition called sarcoidosis);
- vasculitis (inflammation of blood vessels);
- tremor (shaking);
- neuropathy (nerve damage);
- stroke;
- hearing loss, buzzing;
- sensation of heart beating irregularly such as skipped beats;
- heart problems that can cause shortness of breath or ankle swelling;
- heart attack;
- a sac in the wall of a major artery, inflammation and clot of a vein; blockage of a blood vessel;
- lung diseases causing shortness of breath (including inflammation);
- pulmonary embolism (blockage in an artery of the lung);
- pleural effusion (abnormal collection of fluid in the pleural space);
- inflammation of the pancreas which causes severe pain in the abdomen and back;
- difficulty in swallowing;
- facial oedema (swelling);
- gallbladder inflammation, gallbladder stones;
- fatty liver (build-up of fat in liver cells);
- night sweats;
- scar;
- abnormal muscle breakdown;
- systemic lupus erythematosus (an immune disorder including inflammation of skin, heart, lung, joints and other organ systems);
- sleep interruptions;
- impotence;
- inflammations.

Rare (may affect up to 1 in 1 000 people)

- leukaemia (cancer affecting the blood and bone marrow);
- severe allergic reaction with shock;
- multiple sclerosis;
- nerve disorders (such as inflammation of the optic nerve to the eye, and Guillain-Barré syndrome, a condition that may cause muscle weakness, abnormal sensations, tingling in the arms and upper body);
- heart stops pumping;
- pulmonary fibrosis (scarring of the lung);
- intestinal perforation (hole in the wall of the gut);
- hepatitis (liver inflammation);
- reactivation of hepatitis B infection;
- autoimmune hepatitis (inflammation of the liver caused by the body's own immune system);
- cutaneous vasculitis (inflammation of blood vessels in the skin);

- Stevens-Johnson syndrome (life-threatening reaction with flu-like symptoms and blistering rash);
- facial oedema (swelling) associated with allergic reactions;
- erythema multiforme (inflammatory skin rash);
- lupus-like syndrome;
- angioedema (localised swelling of the skin);
- lichenoid skin reaction (itchy reddish-purple skin rash).

Not known (frequency cannot be estimated from available data)

- hepatosplenic T-cell lymphoma (a rare blood cancer that is often fatal);
- Merkel cell carcinoma (a type of skin cancer);
- Kaposi's sarcoma, a rare cancer related to infection with human herpes virus 8. Kaposi's sarcoma most commonly appears as purple lesions on the skin;
- liver failure;
- worsening of a condition called dermatomyositis (seen as a skin rash accompanying muscle weakness).
- weight gain (for most patients, the weight gain was small)

Some side effects observed with adalimumab may not have symptoms and may only be discovered through blood tests. These include:

Very common (may affect more than 1 in 10 people)

- low blood measurements for white blood cells;
- low blood measurements for red blood cells;
- increased lipids in the blood;
- raised liver enzymes.

Common (may affect up to 1 in 10 people)

- high blood measurements for white blood cells;
- low blood measurements for platelets;
- increased uric acid in the blood;
- abnormal blood measurements for sodium;
- low blood measurements for calcium;
- low blood measurements for phosphate;
- high blood sugar;
- high blood measurements for lactate dehydrogenase;
- autoantibodies present in the blood;
- low blood potassium.

Uncommon (may affect up to 1 in 100 people)

- raised bilirubin measurement (liver blood test).

Rare (may affect up to 1 in 1 000 people)

- low blood measurements for white blood cells, red blood cells and platelet count.

Reporting of side effects

If you get any side effects, talk to your doctor or pharmacist. This includes any possible side effects not listed in this leaflet. You can also report side effects directly via [the national reporting system listed in Appendix V](#). By reporting side effects, you can help provide more information on the safety

of this medicine.

5. How to store Hyrimoz

Keep this medicine out of the sight and reach of children.

Do not use this medicine after the expiry date which is stated on the label/blister/carton after EXP. The expiry date refers to the last day of that month.

Store in a refrigerator (2°C–8°C). Do not freeze.

Keep the pre-filled syringe in the outer carton in order to protect from light.

Alternative Storage:

When needed (for example when you are travelling), Hyrimoz may be stored at room temperature (up to 25°C) for a maximum period of 42 days – be sure to protect it from light. Once removed from the refrigerator for room temperature storage, your pre-filled syringe **must be used within 42 days or discarded**, even if it is later returned to the refrigerator. You should record the date when your pre-filled syringe is first removed from the refrigerator, and the date after which it should be discarded.

Do not throw away any medicines via wastewater or household waste. Ask your pharmacist how to throw away medicines you no longer use. These measures will help protect the environment.

6. Contents of the pack and other information

What Hyrimoz contains

- The active substance is adalimumab. Each pre-filled syringe contains 40 mg of adalimumab in 0.4 ml of solution.
- The other ingredients are adipic acid, mannitol (E 421), polysorbate 80 (E 433), hydrochloric acid (E 507), sodium hydroxide (E 524) and water for injections (see section 2 “Hyrimoz contains sodium”).

What Hyrimoz looks like and contents of the pack

Hyrimoz 40 mg solution for injection (injection) in pre-filled syringe is supplied as a 0.4 ml clear to slightly opalescent, colourless or slightly yellowish solution.

Hyrimoz is supplied in a single-use clear type I glass syringe with a stainless steel 29 gauge needle with a needle guard with finger flange, rubber needle cap (thermoplastic elastomer) and plastic plunger rod, containing 0.4 ml of solution.

Cartons contain 1 and 2 pre-filled syringes of Hyrimoz.

Multipack cartons contain 6 (3 packs of 2) pre-filled syringes of Hyrimoz.

Not all pack sizes may be marketed.

Hyrimoz is available as a pre-filled syringe and a pre-filled pen.

Marketing Authorisation Holder

Sandoz GmbH
Biochemiestr. 10
6250 Kundl
Austria

Manufacturer

Sandoz GmbH Schaftenu
Biochemiestr. 10
6336 Langkampfen
Austria

Novartis Pharmaceutical Manufacturing GmbH
Biochemiestrasse 10
6336 Langkampfen
Austria

For any information about this medicine, please contact the local representative of the Marketing Authorisation Holder:

België/Belgique/Belgien

Sandoz nv/sa
Tél/Tel: +32 2 722 97 97

Lietuva

Sandoz Pharmaceuticals d.d filialas
Tel: +370 5 2636 037

България

Сандоз България КЧТ
Тел.: +359 2 970 47 47

Luxembourg/Luxemburg

Sandoz nv/sa (Belgique/Belgien)
Tél/Tel.: +32 2 722 97 97

Česká republika

Sandoz s.r.o.
Tel: +420 225 775 111

Magyarország

Sandoz Hungária Kft.
Tel.: +36 1 430 2890

Danmark/Norge/Ísland/Sverige

Sandoz A/S
Tlf./Sími/Tel: +45 63 95 10 00

Malta

Sandoz Pharmaceuticals d.d.
Tel: +356 99644126

Deutschland

Hexal AG
Tel: +49 8024 908 0

Nederland

Sandoz B.V.
Tel: +31 36 52 41 600

Eesti

Sandoz d.d. Eesti filiaal
Tel: +372 665 2400

Österreich

Sandoz GmbH
Tel: +43 5338 2000

Ελλάδα

SANDOZ HELLAS ΜΟΝΟΠΡΟΣΩΠΗ Α.Ε.
Τηλ: +30 216 600 5000

Polska

Sandoz Polska Sp. z o.o.
Tel.: +48 22 209 70 00

España

Sandoz Farmacéutica, S.A.
Tel: +34 900 456 856

Portugal

Sandoz Farmacêutica Lda.
Tel: +351 21 000 86 00

France

Sandoz SAS
Tél: +33 1 49 64 48 00

România

Sandoz Pharmaceuticals SRL
Tel: +40 21 407 51 60

Hrvatska

Sandoz d.o.o.
Tel: +385 1 23 53 111

Ireland

Rowex Ltd.
Tel: + 353 27 50077

Italia

Sandoz S.p.A.
Tel: +39 02 96541

Κόπος

SANDOZ HELLAS MONOΠΡΟΣΩΠΗ Α.Ε.
(Ελλάδα)
Τηλ: +30 216 600 5000

Latvija

Sandoz d.d. Latvia filiāle
Tel: +371 67 892 006

Slovenija

Sandoz farmacevtska družba d.d.
Tel: +386 1 580 29 02

Slovenská republika

Sandoz d.d. - organizačná zložka
Tel: +421 2 48 200 600

Suomi/Finland

Sandoz A/S
Puh/Tel: +358 10 6133 400

United Kingdom (Northern Ireland)

Sandoz GmbH
Tel: +43 5338 2000

This leaflet was last revised in

Other sources of information

Detailed information on this medicine is available on the European Medicines Agency web site:
<https://www.ema.europa.eu>.

7. Instructions for use

To help avoid possible infections and to ensure that you use the medicine correctly, it is important that you follow these instructions.

Be sure that you read, understand, and follow these Instructions for Use before injecting Hyrimoz. Your healthcare provider should show you how to prepare and inject Hyrimoz properly using the single-dose pre-filled syringe before you use it for the first time. Talk to your healthcare provider if you have any questions.

Your Hyrimoz single-use pre-filled syringe with needle guard and add-on finger flange

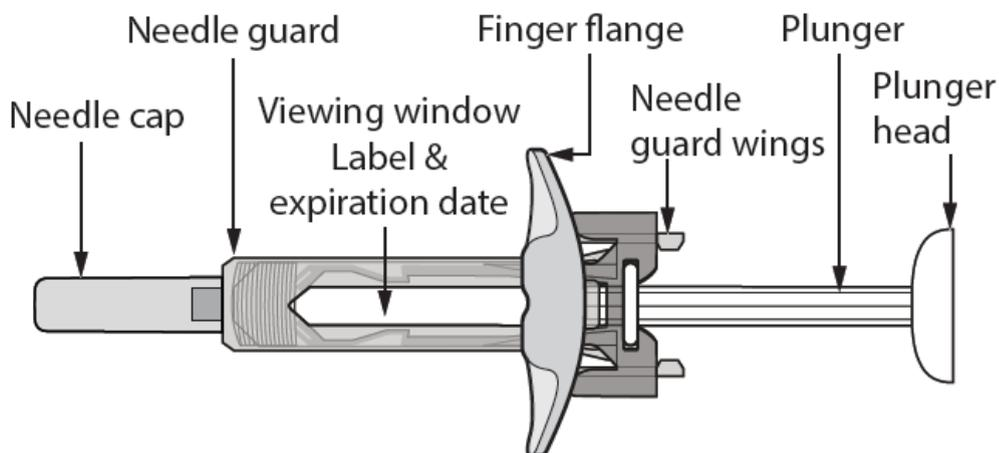

Figure A: Hyrimoz pre-filled syringe with needle guard and finger flange

It is important that you:

- **do not use** the pre-filled syringe if the seals of the blister are broken, as it may not be safe for you to use.
- **do not open** the outer box until you are ready to use the pre-filled syringe.
- **never leave** the pre-filled syringe unattended where others might tamper with it.
- if you drop your syringe, **do not use** it if it looks damaged, or if you dropped it with the needle cap removed.
- **do not remove** the needle cap until just before you give the injection.
- **be careful not to touch the needle guard wings** before use. Touching them may cause the needle guard to be activated too early.
- **do not remove** the finger flange before the injection.
- **inject** Hyrimoz 15–30 minutes after taking it out of the refrigerator for a more comfortable injection.
- throw away the used syringe right away after use. **Do not re-use a pre-filled syringe.** See “4. Disposing of used pre-filled syringes” at the end of these Instructions for Use.

How should you store Hyrimoz single-dose pre-filled syringe?

- Store your outer carton of pre-filled syringes in a refrigerator, between 2°C to 8°C.
 - When needed (for example when you are travelling), Hyrimoz may be stored at room temperature (up to 25°C) for a maximum period of 42 days – be sure to protect it from light. Once removed from the refrigerator for room temperature storage, your pre-filled syringe **must be used within 42 days or discarded**, even if it is later returned to the refrigerator. You should record the date when your pre-filled syringe is first removed from the refrigerator, and the date after which it should be discarded.
 - Keep your pre-filled syringes in the original carton until ready to use to protect from light.
 - Do not store the pre-filled syringes in extreme heat or cold.
 - Do not freeze the pre-filled syringes.
- Keep Hyrimoz and all medicines out of the reach of children.**

What do you need for your injection?

Place the following items on a clean, flat surface.

Included in your pre-filled syringe carton are:

- Hyrimoz pre-filled syringe/s (see **Figure A**). Each pre-filled syringe contains 40 mg/0.4 ml of adalimumab.

Not included in your HYRIMOZ pre-filled syringe carton are (see **Figure B**):

- Alcohol wipe
- Cotton ball or gauze
- Sharps disposal container. See “4. Disposing of used pre-filled syringes” at the end of this Instructions for Use.
- Adhesive bandage

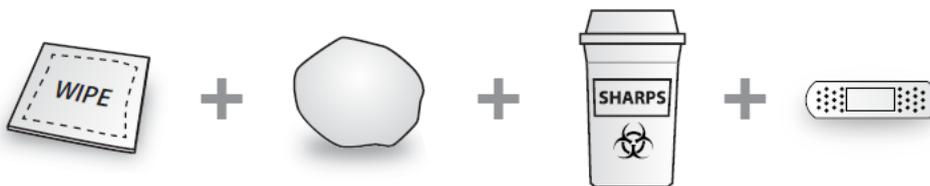

Figure B: items **not** included in the carton

Before your injection

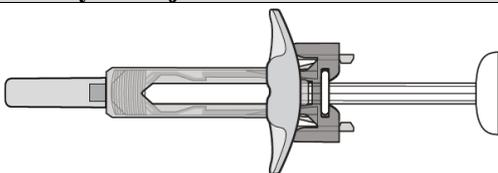

Figure C: needle guard is not activated – the syringe is ready for use

- In this configuration the needle guard is **NOT ACTIVATED**.
- The syringe is ready for use (see **Figure C**).

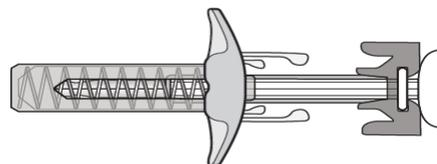

Figure D: needle guard is activated – do not use

- In this configuration the needle guard is **ACTIVATED**.
- **DO NOT USE** the syringe (see **Figure D**).

Preparing the syringe

- For a more comfortable injection, take the carton containing the pre-filled syringe out of the refrigerator and leave it **unopened** on your work surface for about 15 to 30 minutes to allow it to reach room temperature.
- Take the pre-filled syringe out of the blister.
- Look through the viewing window. The solution should be colourless or slightly yellowish as well as clear to slightly opalescent. Do not use if any particulates and/or discolorations are observed. If you are concerned with the appearance of the solution, then contact your pharmacist for assistance.
- **Do not use** the pre-filled syringe if it is broken or the needle guard is activated. Return the pre-filled syringe and the package it came in to the pharmacy.
- Look at the expiry date (EXP) on your pre-filled syringe. Do not use your pre-filled syringe if the expiry date has passed.

Contact your pharmacist if the syringe fails any of the above mentioned checks.

1. Choosing your injection site:

- The recommended injection site is the front of your thighs. You may also use the lower abdomen, but not the area 5 cm around your navel (belly button) (see *Figure E*).
- Choose a different site each time you give yourself an injection.
- **Do not** inject into areas where the skin is tender, bruised, red, scaly, or hard. Avoid areas with scars or stretch marks. If you have psoriasis, you should NOT inject directly into areas with psoriasis plaques.

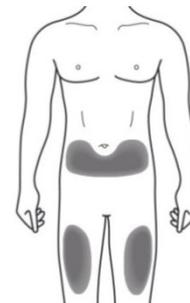

Figure E: choose your injection site

2. Cleaning your injection site:

- Wash your hands well with soap and water.
- Using a circular motion, clean the injection site with an alcohol wipe. Let it dry before injecting (see *Figure F*).
- **Do not** touch the cleaned area before injecting.

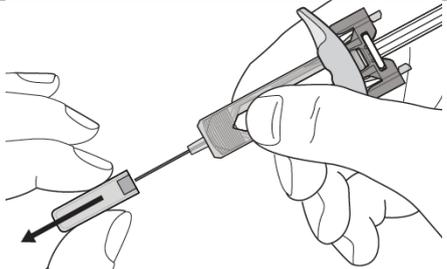
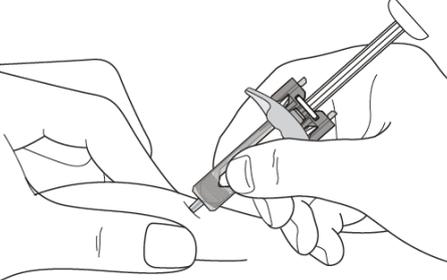
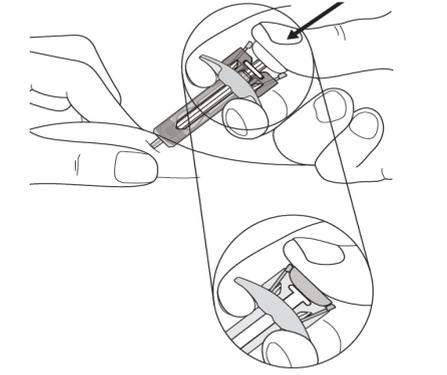
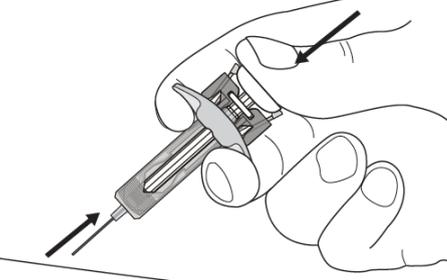
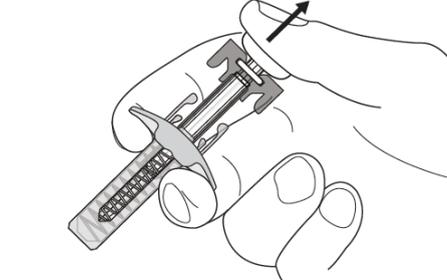

Figure F: clean your injection site

<p>3. Giving your injection:</p> <ul style="list-style-type: none"> Carefully pull the needle cap straight off to remove it from the pre-filled syringe (see Figure G). Discard the needle cap. You may see a drop of liquid at the end of the needle. This is normal. 	 <p>Figure G: pull the needle cap off</p>
<ul style="list-style-type: none"> Gently pinch the skin at the injection site (see Figure H). Insert the needle into your skin as shown. Push the needle all the way in to ensure that the medicine can be fully administered Use your syringe within 5 minutes of removing the cap. 	 <p>Figure H: insert the needle</p>
<ul style="list-style-type: none"> Hold the pre-filled syringe as shown (see Figure I). Slowly press down on the plunger as far as it will go, so that the plunger head is completely between the needle guard wings. Keep the plunger pressed fully down while you hold the syringe in place for 5 seconds. 	 <p>Figure I: hold the syringe</p>
<ul style="list-style-type: none"> Keep the plunger fully pressed down while you carefully lift the needle straight out from the injection site and let go of your skin (see Figure J). 	 <p>Figure J: lift the needle straight out</p>
<ul style="list-style-type: none"> Slowly release the plunger and allow the needle safety guard to automatically cover the exposed needle (see Figure K). There may be a small amount of blood at the injection site. You can press a cotton ball or gauze onto the injection site and hold it for 10 seconds. Do not rub the injection site. You may cover the injection site with a small adhesive bandage, if needed. 	 <p>Figure K: slowly release the plunger</p>

4. Disposing of used syringes:

- Dispose of the used syringe in a sharps container (closable, puncture-resistant container, see *Figure L*). For the safety and health of you and others, needles and used syringes must never be re-used.
- Do not throw away any medicines via wastewater or household waste. Ask your doctor or pharmacist how to throw away medicines you no longer use. These measures will help protect the environment. Any unused product or waste material should be disposed of in accordance with local requirements.



Figure L: dispose of your used syringe

If you have any questions, please talk to a doctor, pharmacist or nurse who is familiar with Hyrimoz.

Package leaflet: Information for the patient

Hyrimoz 40 mg solution for injection in pre-filled pen adalimumab 40 mg/0.4 ml

Read all of this leaflet carefully before you start using this medicine because it contains important information for you.

- Keep this leaflet. You may need to read it again.
- Your doctor will also give you a **Patient Reminder Card**, which contains important safety information that you need to be aware of before you are given Hyrimoz and during treatment with Hyrimoz. Keep this **Patient Reminder Card** with you during your treatment and for 4 months after your (or your child's) last injection of Hyrimoz.
- If you have any further questions, please ask your doctor or pharmacist.
- This medicine has been prescribed for you only. Do not pass it on to others. It may harm them, even if their signs of illness are the same as yours.
- If you get any side effects, talk to your doctor or pharmacist. This includes any possible side effects not listed in this leaflet. See section 4.

What is in this leaflet

1. What Hyrimoz is and what it is used for
2. What you need to know before you use Hyrimoz
3. How to use Hyrimoz
4. Possible side effects
5. How to store Hyrimoz
6. Contents of the pack and other information
7. Instructions for use

1. What Hyrimoz is and what it is used for

Hyrimoz contains the active substance adalimumab, a medicine that acts on your body's immune (defence) system.

Hyrimoz is intended for the treatment of the following inflammatory diseases:

- rheumatoid arthritis,
- polyarticular juvenile idiopathic arthritis,
- enthesitis-related arthritis,
- ankylosing spondylitis,
- axial spondyloarthritis without radiographic evidence of ankylosing spondylitis,
- psoriatic arthritis,
- plaque psoriasis,
- hidradenitis suppurativa,
- Crohn's disease,
- ulcerative colitis,
- non-infectious uveitis.

The active substance in Hyrimoz, adalimumab, is a monoclonal antibody. Monoclonal antibodies are proteins that attach to a specific target in the body.

The target of adalimumab is another protein called tumour necrosis factor (TNF α), which is present at increased levels in the inflammatory diseases listed above. By attaching to TNF α , Hyrimoz blocks its action and reduces the inflammation in these diseases.

Rheumatoid arthritis

Rheumatoid arthritis is an inflammatory disease of the joints.

Hyrimoz is used to treat rheumatoid arthritis in adults. If you have moderate to severe active rheumatoid arthritis, you may first be given other disease-modifying medicines, such as methotrexate. If these medicines do not work well enough, you will be given Hyrimoz to treat your rheumatoid arthritis.

Hyrimoz can also be used to treat severe, active and progressive rheumatoid arthritis without previous methotrexate treatment.

Hyrimoz can slow down the damage to the cartilage and bone of the joints caused by the disease and improve physical function.

Usually, Hyrimoz is used with methotrexate. If your doctor considers that methotrexate is inappropriate, Hyrimoz can be given alone.

Polyarticular juvenile idiopathic arthritis

Polyarticular juvenile idiopathic arthritis is an inflammatory disease of the joints that usually first appear in childhood.

Hyrimoz is used to treat polyarticular juvenile idiopathic arthritis in children and adolescents aged 2 to 17 years. Patients may first be given other disease-modifying medicines, such as methotrexate. If these medicines do not work well enough, patients will be given Hyrimoz.

Enthesitis-related arthritis

Enthesitis-related arthritis is an inflammatory disease of the joints and the places where tendons join the bone. Hyrimoz is used to treat enthesitis-related arthritis in patients from 6 years of age.

Patients may first be given other disease-modifying medicines, such as methotrexate.

If these medicines do not work well enough, patients will be given Hyrimoz.

Ankylosing spondylitis and axial spondyloarthritis without radiographic evidence of ankylosing spondylitis

Ankylosing spondylitis and axial spondyloarthritis without radiographic evidence of ankylosing spondylitis, are inflammatory diseases of the spine.

Hyrimoz is used in adults to treat these conditions. If you have ankylosing spondylitis or axial spondyloarthritis without radiographic evidence of ankylosing spondylitis, you will first be given other medicines. If these medicines do not work well enough, you will be given Hyrimoz to reduce the signs and symptoms of your disease.

Plaque psoriasis in adults and children

Plaque psoriasis is an inflammatory skin condition that causes red, flaky, crusty patches of skin covered with silvery scales. Plaque psoriasis can also affect the nails, causing them to crumble, become thickened and lift away from the nail bed which can be painful. Psoriasis is believed to be caused by a problem with the body's immune system that leads to an increased production of skin cells.

Hyrimoz is used to treat moderate to severe plaque psoriasis in adults. Hyrimoz is also used to treat severe plaque psoriasis in children and adolescents aged 4 to 17 years for whom medicines applied to the skin and treatment with UV light have either not worked very well or are not suitable.

Psoriatic arthritis

Psoriatic arthritis is an inflammatory disease of the joints associated with psoriasis.

Hyrimoz is used to treat psoriatic arthritis in adults. Hyrimoz can slow down the damage to the cartilage and bone of the joints caused by the disease and improve physical function.

Hidradenitis suppurativa in adults and adolescents

Hidradenitis suppurativa (sometimes called acne inversa) is a long-term and often painful inflammatory skin disease. Symptoms may include tender nodules (lumps) and abscesses (boils) that may leak pus.

It most commonly affects specific areas of the skin, such as under the breasts, the armpits, inner thighs, groin and buttocks. Scarring may also occur in affected areas.

Hyrimoz is used to treat

- moderate to severe hidradenitis suppurativa in adults and
- moderate to severe hidradenitis suppurativa in adolescents aged 12 to 17 years.

Hyrimoz can reduce the number of nodules and abscesses you have, and the pain that is often associated with the disease. You may first be given other medicines. If these medicines do not work well enough, you will be given Hyrimoz.

Crohn's disease in adults and children

Crohn's disease is an inflammatory disease of the gut.

Hyrimoz is used to treat

- moderate to severe Crohn's disease in adults
- moderate to severe Crohn's disease in children and adolescents aged 6 to 17 years.

If you have Crohn's disease you will first be given other medicines. If you do not respond well enough to these medicines, you will be given Hyrimoz to reduce the signs and symptoms of your Crohn's disease.

Ulcerative colitis in adults and children

Ulcerative colitis is an inflammatory disease of large intestine.

Hyrimoz is used to treat

- moderate to severe ulcerative colitis in adults and
- moderate to severe ulcerative colitis in children and adolescents aged 6 to 17 years.

If you have ulcerative colitis you may first be given other medicines. If these medicines do not work well enough, you will be given Hyrimoz to reduce the signs and symptoms of your ulcerative colitis.

Non-infectious uveitis in adults and children

Non-infectious uveitis is an inflammatory disease affecting certain parts of the eye. The inflammation leads to a decrease of vision and/or the presence of floaters in the eye (black dots or wispy lines that move across the field of vision). Hyrimoz works by reducing this inflammation.

Hyrimoz is used to treat

- adults with non-infectious uveitis with inflammation affecting the back of the eye.
- children from 2 years of age with chronic non-infectious uveitis with inflammation affecting the front of the eye.

You may first be given other medicines. If you do not respond well enough to these medicines, you will be given Hyrimoz.

2. What you need to know before you use Hyrimoz

Do not use Hyrimoz

- if you are allergic to adalimumab or any of the other ingredients of this medicine (listed in section 6).
- if you have a severe infection, including tuberculosis, sepsis (blood poisoning) or other opportunistic infections (unusual infections associated with a weakened immune system). It is important that you tell your doctor if you have symptoms of infections, e.g. fever, wounds, feeling tired, dental problems (see “Warnings and precautions”).
- if you have moderate or severe heart failure. It is important to tell your doctor if you have had or have a serious heart condition (see “Warnings and precautions”).

Warnings and precautions

Talk to your doctor or pharmacist before using Hyrimoz.

Allergic reaction

- If you have allergic reactions with symptoms such as chest tightness, wheezing, dizziness, swelling or rash, do not inject more Hyrimoz and contact your doctor immediately, since in rare cases, these reactions can be life-threatening.

Infections

- If you have an infection, including long-term or localised infection (for example leg ulcer), consult your doctor before starting Hyrimoz. If you are unsure, contact your doctor.
- You might get infections more easily while you are receiving Hyrimoz treatment. This risk may increase if your lung function is reduced. These infections may be more serious and include tuberculosis, infections caused by viruses, fungi, parasites or bacteria, or other unusual infectious organisms and sepsis (blood poisoning).
- In rare cases, these infections may be life-threatening. It is important to tell your doctor if you get symptoms such as fever, wounds, feeling tired or dental problems. Your doctor may recommend temporarily stopping Hyrimoz.

Tuberculosis (TB)

- As cases of tuberculosis have been reported in patients treated with adalimumab, your doctor will check you for signs and symptoms of tuberculosis before starting Hyrimoz. This will include a thorough medical evaluation including your medical history and screening tests (for example chest X-ray and a tuberculin test). The conduct and results of these tests should be recorded on your **Patient Reminder Card**. It is very important that you tell your doctor if you have ever had tuberculosis, or if you have been in close contact with someone who has had tuberculosis. Tuberculosis can develop during therapy even if you have had preventative treatment for tuberculosis. If symptoms of tuberculosis (persistent cough, weight loss, lack of energy, mild fever), or any other infection appear during or after therapy tell your doctor immediately.

Travel/recurrent infection

- Tell your doctor if you have lived or travelled in regions where fungal infections such as histoplasmosis, coccidioidomycosis or blastomycosis are very common.
- Tell your doctor if you have a history of recurrent infections or other conditions that increase the risk of infections.

Hepatitis B virus

- Tell your doctor if you are a carrier of the hepatitis B virus (HBV), if you have active HBV infection or if you think you might be at risk of getting HBV. Your doctor should test you for HBV. Adalimumab can reactivate HBV infection in people who carry this virus. In some rare cases, especially if you are taking other medicines that suppress the immune system, reactivation of HBV infection can be life-threatening.

Age over 65 years

- If you are over 65 years you may be more susceptible to infections while taking Hyrimoz. You and your doctor should pay special attention to signs of infection while you are being treated with Hyrimoz. It is important to tell your doctor if you get symptoms of infections, such as fever, wounds, feeling tired or dental problems.

Surgery or dental procedures

- If you are about to have surgery or dental procedures tell your doctor that you are taking Hyrimoz. Your doctor may recommend temporarily stopping Hyrimoz.

Demyelinating disease

- If you have or develop demyelinating disease (a disease that affects the insulating layer around the nerves, such as multiple sclerosis), your doctor will decide if you should receive or continue to receive Hyrimoz. Tell your doctor immediately if you get symptoms like changes in your vision, weakness in your arms or legs or numbness or tingling in any part of your body.

Vaccine

- Certain vaccines contain living but weakened forms of disease-causing bacteria or viruses and should not be given during treatment with Hyrimoz in case they cause infections. Check with your doctor before you receive any vaccines. It is recommended that, if possible, children be given all the scheduled vaccinations for their age before they start treatment with Hyrimoz.

If you receive Hyrimoz while you are pregnant, your baby may be at higher risk for getting an infection for up to about five months after the last dose you received during pregnancy. It is important that you tell your baby's doctors and other health care professionals about your Hyrimoz use during your pregnancy so they can decide when your baby should receive any vaccine.

Heart failure

- It is important to tell your doctor if you have had or have a serious heart condition. If you have mild heart failure and you are being treated with Hyrimoz, your heart failure status must be closely monitored by your doctor. If you develop new or worsening symptoms of heart failure (e.g. shortness of breath, or swelling of your feet), you must contact your doctor immediately.

Fever, bruising, bleeding or looking pale

- In some patients the body may fail to produce enough of the blood cells that fight off infections or help you to stop bleeding. If you develop a fever that does not go away, or you bruise or bleed very easily or look very pale, call your doctor right away. Your doctor may decide to stop treatment.

Cancer

- There have been very rare cases of certain kinds of cancer in children and adults taking adalimumab or other TNF α blockers. People with more serious rheumatoid arthritis who have had the disease for a long time may have a higher than average risk of getting lymphoma and leukaemia (cancers that affect blood cells and bone marrow). If you take Hyrimoz the risk of getting lymphoma, leukaemia, or other cancers may increase. On rare occasions, a specific and severe type of lymphoma has been observed in patients taking adalimumab. Some of those patients were also treated with the medicines azathioprine or mercaptopurine. Tell your doctor if you are taking azathioprine or mercaptopurine with Hyrimoz.
- In addition cases of non-melanoma skin cancer have been observed in patients taking adalimumab. If new areas of damaged skin appear during or after treatment or if existing marks or areas of damage change appearance, tell your doctor.
- There have been cases of cancers, other than lymphoma, in patients with a specific type of lung disease called chronic obstructive pulmonary disease (COPD) treated with another TNF α blocker. If you have COPD, or are a heavy smoker, you should discuss with your doctor whether treatment with a TNF α blocker is appropriate for you.

Autoimmune diseases

- On rare occasions, treatment with Hyrimoz could result in lupus-like syndrome. Contact your doctor, if symptoms such as persistent unexplained rash, fever, joint pain or tiredness occur.

Children and adolescents

- Vaccinations: if possible, children should be up to date with all vaccinations before using Hyrimoz.

Other medicines and Hyrimoz

Tell your doctor or pharmacist if you are taking, have recently taken or might take any other medicines.

Hyrimoz can be taken together with methotrexate or certain disease-modifying anti-rheumatic agents (sulfasalazine, hydroxychloroquine, leflunomide and injectable gold preparations), corticosteroids or pain medications including non-steroidal anti-inflammatory drugs (NSAIDs).

You should not take Hyrimoz with medicines containing the active substances anakinra or abatacept due to increased risk of serious infection. The combination of adalimumab as well as other TNF-antagonists and anakinra or abatacept is not recommended based upon the possible increased risk for infections, including serious infections and other potential pharmacological interactions. If you have questions, please ask your doctor.

Pregnancy and breast-feeding

- You should consider the use of adequate contraception to prevent pregnancy and continue its use for at least 5 months after the last Hyrimoz treatment.
- If you are pregnant, think you may be pregnant or are planning to have a baby, ask your doctor for advice before taking this medicine.
- Hyrimoz should only be used during a pregnancy if needed.
- According to a pregnancy study, there was no higher risk of birth defects when the mother had received adalimumab during pregnancy compared with mothers with the same disease who did not receive adalimumab.
- Hyrimoz can be used during breast-feeding.
- If you receive Hyrimoz during your pregnancy, your baby may have a higher risk for getting an infection.
- It is important that you tell your baby's doctors and other health care professionals about your Hyrimoz use during your pregnancy before the baby receives any vaccine (for more information on vaccines see the "Warnings and precautions" section).

Driving and using machines

Hyrimoz may have a minor influence on your ability to drive, cycle or use machines. Room spinning sensation (vertigo) and vision disturbances may occur after taking Hyrimoz.

Hyrimoz contains sodium

This medicine contains less than 1 mmol of sodium (23 mg) per 0.4 ml dose, that is to say essentially 'sodium-free'.

3. How to use Hyrimoz

Always use this medicine exactly as your doctor or pharmacist has told you. Check with your doctor or pharmacist if you are not sure.

The recommended doses for Hyrimoz in each of the approved uses are shown in the following table. Your doctor may prescribe another strength of Hyrimoz if you need a different dose.

Rheumatoid arthritis, psoriatic arthritis, ankylosing spondylitis or axial spondyloarthritis without radiographic evidence of ankylosing spondylitis		
Age or body weight	How much and how often to take?	Notes
Adults	40 mg every other week as a single dose.	<p>In rheumatoid arthritis, methotrexate is continued while using Hyrimoz. If your doctor determines that methotrexate is inappropriate, Hyrimoz can be given alone.</p> <p>If you have rheumatoid arthritis and you do not receive methotrexate with your Hyrimoz therapy, your doctor may decide to give 40 mg Hyrimoz every week or 80 mg every other week.</p>

Polyarticular juvenile idiopathic arthritis		
Age or body weight	How much and how often to take?	Notes
Children, adolescents and adults from 2 years of age weighing 30 kg or more	40 mg every other week	Not applicable
Children, adolescents from 2 years of age weighing 10 kg to less than 30 kg	20 mg every other week	Not applicable

Enthesitis-related arthritis		
Age or body weight	How much and how often to take?	Notes
Children, adolescents and adults from 6 years of age weighing 30 kg or more	40 mg every other week	Not applicable
Children and adolescents from 6 years of age weighing 15 kg to less than 30 kg	20 mg every other week	Not applicable

Plaque Psoriasis		
Age or body weight	How much and how often to take?	Notes
Adults	First dose of 80 mg (as two 40 mg injections in one day), followed by 40 mg given every other week starting one week after the first dose.	You should continue to inject Hyrimoz for as long as your doctor has told you. If this dose does not work well enough, your doctor may increase the dose to 40 mg every week or 80 mg every other week.

Paediatric plaque psoriasis		
Age or body weight	How much and how often to take?	Notes
Children and adolescents from 4 to 17 years of age weighing 30 kg or more	First dose of 40 mg, followed by 40 mg one week later. Thereafter, the usual dose is 40 mg every other week.	Not applicable
Children and adolescents from 4 to 17 years of age weighing 15 kg to less than 30 kg	First dose of 20 mg, followed by 20 mg one week later. Thereafter, the usual dose is 20 mg every other week.	Not applicable

Hidradenitis suppurativa		
Age or body weight	How much and how often to take?	Notes
Adults	<p>First dose of 160 mg (as four 40 mg injections in one day or two 40 mg injections per day for two consecutive days), followed by an 80 mg dose (as two 40 mg injections on the same day) two weeks later.</p> <p>After two further weeks, continue with a dose of 40 mg every week or 80 mg every other week, as prescribed by your doctor.</p>	It is recommended that you use an antiseptic wash daily on the affected areas.
Adolescents from 12 to 17 years of age weighing 30 kg or more	First dose of 80 mg (as two 40 mg injections in one day), followed by 40 mg every other week starting one week later.	<p>If this dose does not work well enough, your doctor may increase the dose to 40 mg every week or 80 mg every other week.</p> <p>It is recommended that you use an antiseptic wash daily on the affected areas.</p>

Crohn's disease		
Age or body weight	How much and how often to take?	Notes
Adults	<p>First dose of 80 mg (as two 40 mg injections in one day), followed by 40 mg every other week starting two weeks later.</p> <p>If a faster response is required your doctor may prescribe a first dose of 160 mg (as four 40 mg injections in one day or two 40 mg injections per day for two consecutive days), followed by 80 mg (as two 40 mg injections in one day) two weeks later.</p> <p>Thereafter the usual dose is 40 mg every other week.</p>	If this dose does not work well enough, your doctor may increase the dose to 40 mg every week or 80 mg every other week.

Paediatric Crohn's disease		
Age or body weight	How much and how often to take?	Notes
Children and adolescent from 6 to 17 years of age weighing 40 kg or more	<p>First dose of 80 mg (as two 40 mg injections in one day), followed by 40 mg every other week starting two weeks later.</p> <p>If a faster response is required your doctor may prescribe a first dose of 160 mg (as four 40 mg injections in one day or two 40 mg injections per day for two consecutive days), followed by 80 mg (as two 40 mg injections in one day) two weeks later.</p> <p>Thereafter the usual dose is 40 mg every other week.</p>	If this dose does not work well enough, your child's doctor may increase the dose to 40 mg every week or 80 mg every other week.
Children and adolescents from 6 to 17 years of age weighing less than 40 kg	<p>First dose of 40 mg, followed by 20 mg every other week starting two weeks later.</p> <p>If a faster response is required, your doctor may prescribe a first dose of 80 mg (as two 40 mg injections in one day), followed by 40 mg two weeks later.</p> <p>Thereafter the usual dose is 20 mg every other week.</p>	If this dose does not work well enough, your child's doctor may increase the dose frequency to 20 mg every week.

Ulcerative colitis		
Age or body weight	How much and how often to take?	Notes
Adults	<p>First dose is 160 mg (as four 40 mg injections in one day or as two 40 mg injections per day for two consecutive days), followed by 80 mg (as two 40 mg injections in one day) two weeks later.</p> <p>Thereafter, the usual dose is 40 mg every other week.</p>	If this dose does not work well enough, your doctor may increase the dose to 40 mg every week or 80 mg every other week.

Paediatric ulcerative colitis		
Age or body weight	How much and how often to take?	Notes
Children and adolescents from 6 years of age weighing 40 kg or more	<p>First dose is 160 mg (as four 40 mg injections in one day or two 40 mg injections per day for two consecutive days) initially, followed by 80 mg (as</p>	Patients who turn 18 years of age while on 80 mg every other week, should continue their prescribed dose.

	two 40 mg injections in one day) two weeks later. Thereafter the usual dose is 80 mg every other week.	
Children and adolescents from 6 years of age weighing less than 40 kg	First dose is 80 mg (as two 40 mg injections in one day) initially followed by 40 mg (as one 40 mg injection) two weeks later. Thereafter, the usual dose is 40 mg every other week.	Patients who turn 18 years of age while on 40 mg every other week, should continue their prescribed dose.

Non-infectious uveitis		
Age or body weight	How much and how often to take?	Notes
Adults	First dose of 80 mg (as two 40 mg injections), followed by 40 mg every other week starting one week after the first dose.	In non-infectious uveitis, corticosteroids or other medicines that influence the immune system may be continued while using Hyrimoz. Hyrimoz can also be given alone. You should continue to inject Hyrimoz for as long as your doctor has told you.
Children and adolescents from 2 years of age weighing 30 kg or more	40 mg every other week.	Your doctor may also prescribe a first dose of 80 mg which may be administered one week prior to the start of the usual dose of 40mg every other week. Hyrimoz is recommended for the use in combination with methotrexate.
Children and adolescents from 2 years of age weighing less than 30 kg	20 mg every other week.	Your doctor may also prescribe a first dose of 40 mg which may be administered one week prior to the start of the usual dose of 20 mg every other week. Hyrimoz is recommended for the use in combination with methotrexate.

Method and route of administration

Hyrimoz is administered by injection under the skin (by subcutaneous injection).

Detailed instructions on how to inject Hyrimoz are provided in section 7, “**Instructions for use**”.

If you use more Hyrimoz than you should

If you accidentally inject Hyrimoz more frequently than you should, call your doctor or pharmacist

and explain that you have taken more than required. Always take the outer carton of medicine with you, even if it is empty.

If you forget to use Hyrimoz

If you forget to give yourself an injection, you should inject the next dose of Hyrimoz as soon as you remember. Then take your next dose as you would have on your originally scheduled day, had you not forgotten a dose.

If you stop using Hyrimoz

The decision to stop using Hyrimoz should be discussed with your doctor. Your symptoms may return upon stopping treatment.

If you have any further questions on the use of this medicine, ask your doctor or pharmacist.

4. Possible side effects

Like all medicines, this medicine can cause side effects, although not everybody gets them. Most side effects are mild to moderate. However, some may be serious and require treatment. Side effects may occur up to 4 months or more after the last Hyrimoz injection.

Seek medical attention urgently, if you notice any of the following signs of allergic reaction or heart failure:

- severe rash, hives;
- swollen face, hands, feet;
- trouble breathing, swallowing;
- shortness of breath with physical activity or upon lying down or swelling of the feet.

Tell your doctor as soon as possible, if you notice any of the following:

- signs and symptoms of infection such as fever, feeling sick, wounds, dental problems, burning on urination, feeling weak or tired or coughing;
- symptoms of nerve problems such as tingling, numbness, double vision or arm or leg weakness;
- signs of skin cancer such as a bump or open sore that doesn't heal;
- signs and symptoms suggestive of blood disorders such as persistent fever, bruising, bleeding, paleness.

The following side effects have been observed with adalimumab:

Very common (may affect more than 1 in 10 people)

- injection site reactions (including pain, swelling, redness or itching);
- respiratory tract infections (including cold, runny nose, sinus infection, pneumonia);
- headache;
- abdominal (belly) pain;
- nausea and vomiting;
- rash;
- pain in the muscles.

Common (may affect up to 1 in 10 people)

- serious infections (including blood poisoning and influenza);
- intestinal infections (including gastroenteritis);

- skin infections (including cellulitis and shingles);
- ear infections;
- mouth infections (including tooth infections and cold sores);
- reproductive tract infections;
- urinary tract infection;
- fungal infections;
- joint infections;
- benign tumours;
- skin cancer;
- allergic reactions (including seasonal allergy);
- dehydration;
- mood swings (including depression);
- anxiety;
- difficulty sleeping;
- sensation disorders such as tingling, prickling or numbness;
- migraine;
- symptoms of nerve root compression (including low back pain and leg pain);
- vision disturbances;
- eye inflammation;
- inflammation of the eye lid and eye swelling;
- vertigo (sensation of room spinning);
- sensation of heart beating rapidly;
- high blood pressure;
- flushing;
- haematoma (a solid swelling with clotted blood);
- cough;
- asthma;
- shortness of breath;
- gastrointestinal bleeding;
- dyspepsia (indigestion, bloating, heart burn);
- acid reflux disease;
- sicca syndrome (including dry eyes and dry mouth);
- itching;
- itchy rash;
- bruising;
- inflammation of the skin (such as eczema);
- breaking of finger nails and toe nails;
- increased sweating;
- hair loss;
- new onset or worsening of psoriasis;
- muscle spasms;
- blood in urine;
- kidney problems;
- chest pain;
- oedema (a build-up of fluid in the body which causes the affected tissue to swell);
- fever;
- reduction in blood platelets which increases risk of bleeding or bruising;
- impaired healing.

Uncommon (may affect up to 1 in 100 people)

- unusual infections (which include tuberculosis and other infections) that occur when resistance to disease is lowered;
- neurological infections (including viral meningitis);

- eye infections;
- bacterial infections;
- diverticulitis (inflammation and infection of the large intestine);
- cancer, including cancer that affects the lymph system (lymphoma) and melanoma (a type of skin cancer);
- immune disorders that could affect the lungs, skin and lymph nodes (most commonly as a condition called sarcoidosis);
- vasculitis (inflammation of blood vessels);
- tremor (shaking);
- neuropathy (nerve damage);
- stroke;
- hearing loss, buzzing;
- sensation of heart beating irregularly such as skipped beats;
- heart problems that can cause shortness of breath or ankle swelling;
- heart attack;
- a sac in the wall of a major artery, inflammation and clot of a vein; blockage of a blood vessel;
- lung diseases causing shortness of breath (including inflammation);
- pulmonary embolism (blockage in an artery of the lung);
- pleural effusion (abnormal collection of fluid in the pleural space);
- inflammation of the pancreas which causes severe pain in the abdomen and back;
- difficulty in swallowing;
- facial oedema (swelling);
- gallbladder inflammation, gallbladder stones;
- fatty liver (build-up of fat in liver cells);
- night sweats;
- scar;
- abnormal muscle breakdown;
- systemic lupus erythematosus (an immune disorder including inflammation of skin, heart, lung, joints and other organ systems);
- sleep interruptions;
- impotence;
- inflammations.

Rare (may affect up to 1 in 1 000 people)

- leukaemia (cancer affecting the blood and bone marrow);
- severe allergic reaction with shock;
- multiple sclerosis;
- nerve disorders (such as inflammation of the optic nerve to the eye, and Guillain-Barré syndrome, a condition that may cause muscle weakness, abnormal sensations, tingling in the arms and upper body);
- heart stops pumping;
- pulmonary fibrosis (scarring of the lung);
- intestinal perforation (hole in the wall of the gut);
- hepatitis (liver inflammation);
- reactivation of hepatitis B infection;
- autoimmune hepatitis (inflammation of the liver caused by the body's own immune system);
- cutaneous vasculitis (inflammation of blood vessels in the skin);
- Stevens-Johnson syndrome (life-threatening reaction with flu-like symptoms and blistering rash);
- facial oedema (swelling) associated with allergic reactions;
- erythema multiforme (inflammatory skin rash);
- lupus-like syndrome;
- angioedema (localised swelling of the skin);

- lichenoid skin reaction (itchy reddish-purple skin rash).

Not known (frequency cannot be estimated from available data)

- hepatosplenic T-cell lymphoma (a rare blood cancer that is often fatal);
- Merkel cell carcinoma (a type of skin cancer);
- Kaposi's sarcoma, a rare cancer related to infection with human herpes virus 8. Kaposi's sarcoma most commonly appears as purple lesions on the skin;
- liver failure;
- worsening of a condition called dermatomyositis (seen as a skin rash accompanying muscle weakness).
- weight gain (for most patients, the weight gain was small)

Some side effects observed with adalimumab may not have symptoms and may only be discovered through blood tests. These include:

Very common (may affect more than 1 in 10 people)

- low blood measurements for white blood cells;
- low blood measurements for red blood cells;
- increased lipids in the blood;
- raised liver enzymes.

Common (may affect up to 1 in 10 people)

- high blood measurements for white blood cells;
- low blood measurements for platelets;
- increased uric acid in the blood;
- abnormal blood measurements for sodium;
- low blood measurements for calcium;
- low blood measurements for phosphate;
- high blood sugar;
- high blood measurements for lactate dehydrogenase;
- autoantibodies present in the blood;
- low blood potassium.

Uncommon (may affect up to 1 in 100 people)

- raised bilirubin measurement (liver blood test).

Rare (may affect up to 1 in 1 000 people)

- low blood measurements for white blood cells, red blood cells and platelet count.

Reporting of side effects

If you get any side effects, talk to your doctor or pharmacist. This includes any possible side effects not listed in this leaflet. You can also report side effects directly via [the national reporting system listed in Appendix V](#). By reporting side effects, you can help provide more information on the safety of this medicine.

5. How to store Hyrimoz

Keep this medicine out of the sight and reach of children.

Do not use this medicine after the expiry date which is stated on the label/blister/carton after EXP. The expiry date refers to the last day of that month.

Store in a refrigerator (2°C–8°C). Do not freeze.

Keep the pre-filled pen in the outer carton in order to protect from light.

Alternative Storage:

When needed (for example when you are travelling), Hyrimoz may be stored at room temperature (up to 25°C) for a maximum period of 42 days – be sure to protect it from light. Once removed from the refrigerator for room temperature storage, your pre-filled pen **must be used within 42 days or discarded**, even if it is later returned to the refrigerator. You should record the date when your pre-filled pen is first removed from the refrigerator, and the date after which it should be discarded.

Do not throw away any medicines via wastewater or household waste. Ask your pharmacist how to throw away medicines you no longer use. These measures will help protect the environment.

6. Contents of the pack and other information

What Hyrimoz contains

- The active substance is adalimumab. Each pre-filled pen contains 40 mg of adalimumab in 0.4 ml of solution.

• The other ingredients are adipic acid, mannitol (E 421), polysorbate 80 (E 433), hydrochloric acid (E 507), sodium hydroxide (E 524) and water for injections (see section 2 “Hyrimoz contains sodium”).

What Hyrimoz looks like and contents of the pack

Hyrimoz 40 mg solution for injection (injection) in pre-filled pen is supplied as a 0.4 ml clear to slightly opalescent, colourless or slightly yellowish solution.

Hyrimoz is supplied in a single-use pre-filled syringe assembled into a triangular-shaped pen with transparent window and label. The syringe inside the pen is made of type I glass with a stainless steel 29 gauge needle and an inner rubber needle cap (thermoplastic elastomer), containing 0.4 ml of solution.

Cartons contain 1, 2 and 4 pre-filled pens of Hyrimoz.

Multipack cartons contain 6 (3 packs of 2) pre-filled pens of Hyrimoz.

Not all pack sizes may be marketed.

Hyrimoz is available as a pre-filled syringe and a pre-filled pen.

Marketing Authorisation Holder

Sandoz GmbH
Biochemiestr. 10
6250 Kundl
Austria

Manufacturer

Sandoz GmbH Schafftenau
Biochemiestr. 10
6336 Langkampfen
Austria

Novartis Pharmaceutical Manufacturing GmbH
Biochemiestrasse 10
6336 Langkampfen
Austria

For any information about this medicine, please contact the local representative of the Marketing Authorisation Holder:

België/Belgique/Belgien

Sandoz nv/sa
Tél/Tel: +32 2 722 97 97

Lietuva

Sandoz Pharmaceuticals d.d filialas
Tel: +370 5 2636 037

България

Сандоз България КЧТ
Тел.: +359 2 970 47 47

Luxembourg/Luxemburg

Sandoz nv/sa (Belgique/Belgien)
Tél/Tel.: +32 2 722 97 97

Česká republika

Sandoz s.r.o.
Tel: +420 225 775 111

Magyarország

Sandoz Hungária Kft.
Tel.: +36 1 430 2890

Danmark/Norge/Ísland/Sverige

Sandoz A/S
Tlf./Sími/Tel: +45 63 95 10 00

Malta

Sandoz Pharmaceuticals d.d.
Tel: +356 99644126

Deutschland

Hexal AG
Tel: +49 8024 908 0

Nederland

Sandoz B.V.
Tel: +31 36 52 41 600

Eesti

Sandoz d.d. Eesti filiaal
Tel: +372 665 2400

Österreich

Sandoz GmbH
Tel: +43 5338 2000

Ελλάδα

SANDOZ HELLAS ΜΟΝΟΠΡΟΣΩΠΗ Α.Ε.
Τηλ: +30 216 600 5000

Polska

Sandoz Polska Sp. z o.o.
Tel.: +48 22 209 70 00

España

Sandoz Farmacéutica, S.A.
Tel: +34 900 456 856

Portugal

Sandoz Farmacêutica Lda.
Tel: +351 21 000 86 00

France

Sandoz SAS
Tél: +33 1 49 64 48 00

România

Sandoz Pharmaceuticals SRL
Tel: +40 21 407 51 60

Hrvatska

Sandoz d.o.o.
Tel: +385 1 23 53 111

Ireland

Rowex Ltd.
Tel: + 353 27 50077

Italia

Sandoz S.p.A.
Tel: +39 02 96541

Κόσπος

SANDOZ HELLAS MONOΠΡΟΣΩΠΗ Α.Ε.
(Ελλάδα)
Τηλ: +30 216 600 5000

Latvija

Sandoz d.d. Latvia filiāle
Tel: +371 67 892 006

Slovenija

Sandoz farmacevtska družba d.d.
Tel: +386 1 580 29 02

Slovenská republika

Sandoz d.d. - organizačná zložka
Tel: +421 2 48 200 600

Suomi/Finland

Sandoz A/S
Puh/Tel: +358 10 6133 400

United Kingdom (Northern Ireland)

Sandoz GmbH
Tel: +43 5338 2000

This leaflet was last revised in

Other sources of information

Detailed information on this medicine is available on the European Medicines Agency web site:
<https://www.ema.europa.eu>.

7. Instructions for use

To help avoid possible infections and to ensure that you use Hyrimoz correctly, it is important that you follow these instructions.

Be sure that you read, understand, and follow these Instructions for use before injecting Hyrimoz. Your healthcare provider should show you how to prepare and inject Hyrimoz properly using the Hyrimoz single-dose pre-filled pen before you use it for the first time. Talk to your healthcare provider if you have any questions.

Your Hyrimoz single-use pre-filled pen

Figure A: Hyrimoz pen parts

In **Figure A**, the pen is shown with the cap removed. **Do not remove** the cap until you are ready to inject.

It is important that you:

- **do not use** the pen if either the seal on the outer carton or the safety seal on the pen is broken.
- keep your pen in the sealed outer carton until you are ready to use it.
- **never leave** the pen unattended where others might tamper with it.
- **do not use** your pen, if you dropped it, it looks damaged, or if you dropped it with the cap removed.
- **inject** Hyrimoz 15–30 minutes after taking it out of the refrigerator for a more comfortable injection.
- throw away the used pen right away after use. **Do not re-use the pen.** See “8. Disposing of used pens” at the end of this Instructions for Use.

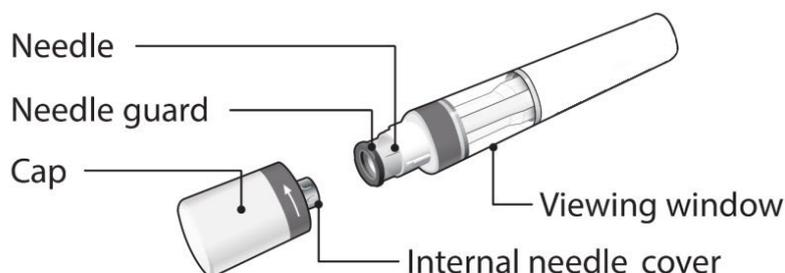
How should you store your pen?

- Store your pen carton in a refrigerator, between 2°C to 8°C.
- When needed, for example when you are travelling, Hyrimoz may be stored at room temperature (up to 25°C) for a maximum period of 42 days. – be sure to protect it from light. Once removed from the refrigerator for room temperature storage, your pre-filled pen **must be used within 42 days or discarded**, even if it is later returned to the refrigerator.
- You should record the date when your pre-filled pen is first removed from the refrigerator, and the date after which it should be discarded.
- Keep your pen in the original carton until ready to use to protect from light.
- Do not store your pen in extreme heat or cold.
- Do not freeze your pen.

Keep Hyrimoz and all medicines out of the reach of children.

What do you need for your injection?

Place the following items on a clean, flat surface.

Included in your carton are:

- Hyrimoz pre-filled pen/s (see *Figure A*). Each pen contains 40 mg/0.4 ml of adalimumab.

Not included in your pen carton are (see *Figure B*):

- Alcohol wipe
- Cotton ball or gauze
- Sharps disposal container See “8. Disposing of used pens” at the end of these Instructions for Use
- Adhesive bandage.

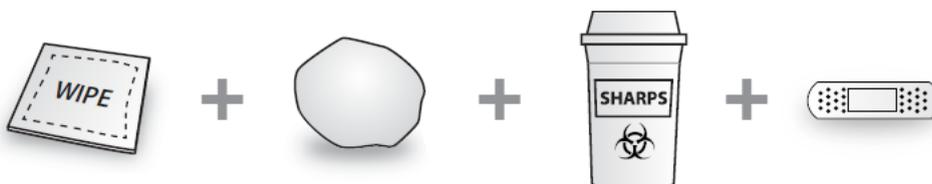
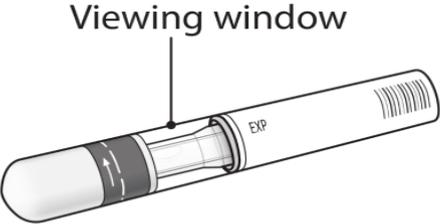
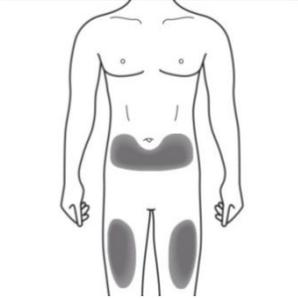
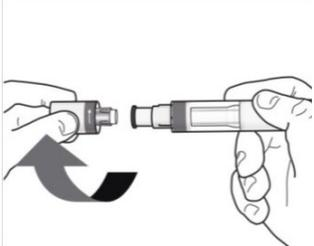

Figure B: items not included in the carton

<p>Before your injection</p> <p>Preparing the pen</p>	
<ul style="list-style-type: none"> • For a more comfortable injection, take your pen out of the refrigerator 15 to 30 minutes before injecting Hyrimoz to allow it to reach room temperature. • Look through the viewing window. The solution should be colourless or slightly yellowish as well as clear to slightly opalescent. Do not use if any particulates and/or discolorations are observed. You may see small air bubbles, which is normal. If you are concerned with the appearance of the solution, then contact your pharmacist for assistance. • Look at the expiry date (EXP) on your pen (see Figure C). Do not use your pen if the expiry date has passed. • Do not use if the safety seal has been broken. <p>Contact your pharmacist if the pen fails any of the above mentioned checks.</p>	 <p>Figure C: Safety Checks before injection</p>

<p>1. Choosing your injection site:</p>	
<ul style="list-style-type: none"> • The recommended injection site is the front of your thighs. You may also use the lower abdomen, but not the area 5 cm around your navel (belly button) (see Figure D). • Choose a different site each time you give yourself an injection. • Do not inject into areas where the skin is tender, bruised, red, scaly, or hard. Avoid areas with scars or stretch marks. • If you have psoriasis, you should NOT inject directly into areas with psoriasis plaques. 	 <p>Figure D: choose your injection site</p>

<p>2. Cleaning your injection site:</p>	
<ul style="list-style-type: none"> • Wash your hands well with soap and water. • Using a circular motion, clean the injection site with an alcohol wipe. Let it dry before injecting (see Figure E). • Do not touch the cleaned area again before injecting. 	 <p>Figure E: clean your injection site</p>

3. Removing the cap of your pen:	
<ul style="list-style-type: none"> • Only remove the cap when you are ready to use the pen. • Twist off the cap in the direction of the arrows (see <i>Figure F</i>). • Once removed, throw away the cap. Do not try to re-attach the cap. • Use your pen within 5 minutes of removing the cap. • You may see a few drops of liquid come out of the needle. This is normal. 	 <p><i>Figure F:</i> remove the cap</p>

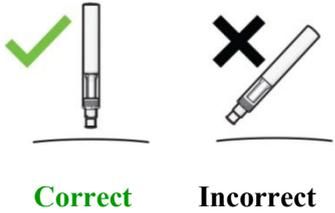
4. Holding the pen:	
<ul style="list-style-type: none"> • Hold your pen at 90 degrees to the cleaned injection site (see <i>Figure G</i>). 	
 <p>Correct Incorrect</p>	 <p><i>Figure G:</i> hold your pen</p>

Your injection

You must read this before injecting

During the injection you will hear **2 loud clicks**:

- The **first click** indicates that the injection has **started**.
- Several seconds later a **second click** will indicate that the injection is **almost** finished.

You **must** keep holding your pen firmly against your skin until you see a **green indicator** fill the window and stop moving.

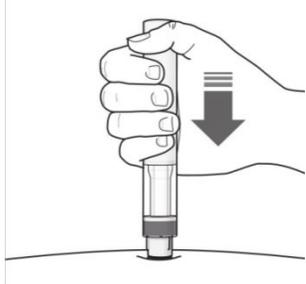
5. Starting your injection:	
<ul style="list-style-type: none"> • Press your pen firmly against the skin to start the injection (see <i>Figure H</i>). • The first click indicates the injection has started. • Keep holding your pen firmly against your skin. • The green indicator shows the progress of the injection. 	 <p><i>Figure H:</i> start your injection</p>

<p>6. Completing your injection:</p>	
<ul style="list-style-type: none"> • Listen for the second click. This indicates the injection is almost complete. • Check the green indicator fills the window and has stopped moving (see <i>Figure I</i>). • The pen can now be removed. 	 <p><i>Figure I:</i> complete your injection</p>

<p>After your injection</p>	
<p>7. Check the green indicator fills the window (see <i>Figure J</i>):</p>	
<ul style="list-style-type: none"> • This means the medicine has been delivered. Contact your doctor if the green indicator is not visible. • There may be a small amount of blood at the injection site. You can press a cotton ball or gauze over the injection site and hold it for 10 seconds. Do not rub the injection site. You may cover the injection site with a small adhesive bandage, if needed. 	 <p><i>Figure J:</i> check the green indicator</p>

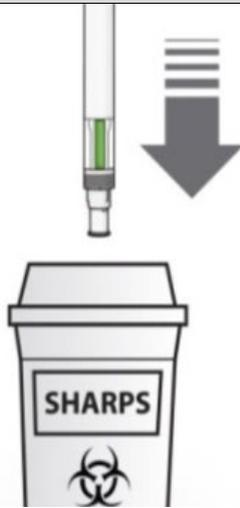
<p>8. Disposing of used pens:</p>	
<ul style="list-style-type: none"> • Dispose of the used pens in a sharps container (closable, puncture-resistant container, see <i>Figure K</i>). For the safety and health of you and others, the pens must never be re-used. • Do not throw away any medicines via wastewater or household waste. Ask your doctor or pharmacist how to throw away medicines you no longer use. These measures will help protect the environment. Any unused product or waste material should be disposed of in accordance with local requirements. 	 <p><i>Figure K:</i> dispose of your used pen</p>

If you have any questions, please talk to a doctor, pharmacist or nurse who is familiar with Hyrimoz.

Package leaflet: Information for the patient

Hyrimoz 80 mg solution for injection in pre-filled syringe adalimumab

Read all of this leaflet carefully before you start using this medicine because it contains important information for you.

- Keep this leaflet. You may need to read it again.
- Your doctor will also give you a **Patient Reminder Card**, which contains important safety information that you need to be aware of before you are given Hyrimoz and during treatment with Hyrimoz. Keep this **Patient Reminder Card** with you during your treatment and for 4 months after your (or your child's) last injection of Hyrimoz.
- If you have any further questions, please ask your doctor or pharmacist.
- This medicine has been prescribed for you only. Do not pass it on to others. It may harm them, even if their signs of illness are the same as yours.
- If you get any side effects, talk to your doctor or pharmacist. This includes any possible side effects not listed in this leaflet. See section 4.

What is in this leaflet

1. What Hyrimoz is and what it is used for
2. What you need to know before you use Hyrimoz
3. How to use Hyrimoz
4. Possible side effects
5. How to store Hyrimoz
6. Contents of the pack and other information
7. Instructions for use

1. What Hyrimoz is and what it is used for

Hyrimoz contains the active substance adalimumab, a medicine that acts on your body's immune (defence) system.

Hyrimoz is intended for the treatment of the following inflammatory diseases:

- rheumatoid arthritis,
- plaque psoriasis,
- hidradenitis suppurativa,
- Crohn's disease,
- ulcerative colitis,
- non-infectious uveitis.

The active substance in Hyrimoz, adalimumab, is a monoclonal antibody. Monoclonal antibodies are proteins that attach to a specific target in the body.

The target of adalimumab is another protein called tumour necrosis factor (TNF α), which is present at increased levels in the inflammatory diseases listed above. By attaching to TNF α , Hyrimoz blocks its action and reduces the inflammation in these diseases.

Rheumatoid arthritis

Rheumatoid arthritis is an inflammatory disease of the joints.

Hyrimoz is used to treat rheumatoid arthritis in adults. If you have moderate to severe active rheumatoid arthritis, you may first be given other disease-modifying medicines, such as methotrexate. If these medicines do not work well enough, you will be given Hyrimoz to treat your rheumatoid arthritis.

Hyrimoz can also be used to treat severe, active and progressive rheumatoid arthritis without previous methotrexate treatment.

Hyrimoz can slow down the damage to the cartilage and bone of the joints caused by the disease and improve physical function.

Usually, Hyrimoz is used with methotrexate. If your doctor considers that methotrexate is inappropriate, Hyrimoz can be given alone.

Plaque psoriasis

Plaque psoriasis is an inflammatory skin condition that causes red, flaky, crusty patches of skin covered with silvery scales. Plaque psoriasis can also affect the nails, causing them to crumble, become thickened and lift away from the nail bed which can be painful. Psoriasis is believed to be caused by a problem with the body's immune system that leads to an increased production of skin cells.

Hyrimoz is used to treat moderate to severe plaque psoriasis in adults.

Hidradenitis suppurativa in adults and adolescents

Hidradenitis suppurativa (sometimes called acne inversa) is a long-term and often painful inflammatory skin disease. Symptoms may include tender nodules (lumps) and abscesses (boils) that may leak pus.

It most commonly affects specific areas of the skin, such as under the breasts, the armpits, inner thighs, groin and buttocks. Scarring may also occur in affected areas.

Hyrimoz is used to treat

- moderate to severe hidradenitis suppurativa in adults and
- moderate to severe hidradenitis suppurativa in adolescents aged 12 to 17 years.

Hyrimoz can reduce the number of nodules and abscesses you have, and the pain that is often associated with the disease. You may first be given other medicines. If these medicines do not work well enough, you will be given Hyrimoz.

Crohn's disease in adults and children

Crohn's disease is an inflammatory disease of the gut.

Hyrimoz is used to treat

- moderate to severe Crohn's disease in adults and
- moderate to severe Crohn's disease in children and adolescents aged 6 to 17 years.

If you have Crohn's disease you will first be given other medicines. If you do not respond well enough to these medicines, you will be given Hyrimoz to reduce the signs and symptoms of your Crohn's disease.

Ulcerative colitis in adults and children

Ulcerative colitis is an inflammatory disease of the large intestine.

Hyrimoz is used to treat

- moderate to severe ulcerative colitis in adults and
- moderate to severe ulcerative colitis in children and adolescents aged 6 to 17 years.

If you have ulcerative colitis you may first be given other medicines. If these medicines do not work

well enough, you will be given Hyrimoz to reduce the signs and symptoms of your ulcerative colitis.

Non-infectious uveitis in adults and children

Non-infectious uveitis is an inflammatory disease affecting certain parts of the eye. The inflammation leads to a decrease of vision and/or the presence of floaters in the eye (black dots or wispy lines that move across the field of vision). Hyrimoz works by reducing this inflammation.

Hyrimoz is used to treat

- adults with non-infectious uveitis with inflammation affecting the back of the eye.
- children from 2 years of age with chronic non-infectious uveitis with inflammation affecting the front of the eye.

You may first be given other medicines. If you do not respond well enough to these medicines, you will be given Hyrimoz.

2. What you need to know before you use Hyrimoz

Do not use Hyrimoz

- if you are allergic to adalimumab or any of the other ingredients of this medicine (listed in section 6).
- if you have a severe infection, including tuberculosis, sepsis (blood poisoning) or other opportunistic infections (unusual infections associated with a weakened immune system). It is important that you tell your doctor if you have symptoms of infections, e.g. fever, wounds, feeling tired, dental problems (see “Warnings and precautions”).
- if you have moderate or severe heart failure. It is important to tell your doctor if you have had or have a serious heart condition (see “Warnings and precautions”).

Warnings and precautions

Talk to your doctor or pharmacist before using Hyrimoz.

Allergic reaction

- If you have allergic reactions with symptoms such as chest tightness, wheezing, dizziness, swelling or rash, do not inject more Hyrimoz and contact your doctor immediately, since in rare cases, these reactions can be life-threatening.

Infections

- If you have an infection, including long-term or localised infection (for example leg ulcer), consult your doctor before starting Hyrimoz. If you are unsure, contact your doctor.
- You might get infections more easily while you are receiving Hyrimoz treatment. This risk may increase if your lung function is reduced. These infections may be more serious and include tuberculosis, infections caused by viruses, fungi, parasites or bacteria, or other unusual infectious organisms and sepsis (blood poisoning).
- In rare cases, these infections may be life-threatening. It is important to tell your doctor if you get symptoms such as fever, wounds, feeling tired or dental problems. Your doctor may recommend temporarily stopping Hyrimoz.

Tuberculosis (TB)

- As cases of tuberculosis have been reported in patients treated with adalimumab, your doctor will check you for signs and symptoms of tuberculosis before starting Hyrimoz. This will include a thorough medical evaluation including your medical history and screening tests (for example chest X-ray and a tuberculin test). The conduct and results of these tests should be recorded on your **Patient Reminder Card**. It is very important that you tell your doctor if you have ever had tuberculosis, or if you have been in close contact with someone who has had tuberculosis. Tuberculosis can develop during therapy even if you have had preventative treatment for tuberculosis. If symptoms of tuberculosis (persistent cough, weight loss, lack of energy, mild fever), or any other infection appear during or after therapy tell your doctor immediately.

Travel/recurrent infection

- Tell your doctor if you have lived or travelled in regions where fungal infections such as histoplasmosis, coccidioidomycosis or blastomycosis are very common.
- Tell your doctor if you have a history of recurrent infections or other conditions that increase the risk of infections.

Hepatitis B virus

- Tell your doctor if you are a carrier of the hepatitis B virus (HBV), if you have active HBV infection or if you think you might be at risk of getting HBV. Your doctor should test you for HBV. Adalimumab can reactivate HBV infection in people who carry this virus. In some rare cases, especially if you are taking other medicines that suppress the immune system, reactivation of HBV infection can be life-threatening.

Age over 65 years

- If you are over 65 years you may be more susceptible to infections while taking Hyrimoz. You and your doctor should pay special attention to signs of infection while you are being treated with Hyrimoz. It is important to tell your doctor if you get symptoms of infections, such as fever, wounds, feeling tired or dental problems.

Surgery or dental procedures

- If you are about to have surgery or dental procedures tell your doctor that you are taking Hyrimoz. Your doctor may recommend temporarily stopping Hyrimoz.

Demyelinating disease

- If you have or develop demyelinating disease (a disease that affects the insulating layer around the nerves, such as multiple sclerosis), your doctor will decide if you should receive or continue to receive Hyrimoz. Tell your doctor immediately if you get symptoms like changes in your vision, weakness in your arms or legs or numbness or tingling in any part of your body.

Vaccine

- Certain vaccines contain living but weakened forms of disease-causing bacteria or viruses and should not be given during treatment with Hyrimoz in case they cause infections. Check with your doctor before you receive any vaccines. It is recommended that, if possible, children be given all the scheduled vaccinations for their age before they start treatment with Hyrimoz. If you receive Hyrimoz while you are pregnant, your baby may be at higher risk for getting an infection for up to about five months after the last dose you received during pregnancy. It is important that you tell your baby's doctors and other health care professionals about your

Hyrimoz use during your pregnancy so they can decide when your baby should receive any vaccine.

Heart failure

- It is important to tell your doctor if you have had or have a serious heart condition. If you have mild heart failure and you are being treated with Hyrimoz, your heart failure status must be closely monitored by your doctor. If you develop new or worsening symptoms of heart failure (e.g. shortness of breath, or swelling of your feet), you must contact your doctor immediately.

Fever, bruising, bleeding or looking pale

- In some patients the body may fail to produce enough of the blood cells that fight off infections or help you to stop bleeding. If you develop a fever that does not go away, or you bruise or bleed very easily or look very pale, call your doctor right away. Your doctor may decide to stop treatment.

Cancer

- There have been very rare cases of certain kinds of cancer in children and adults taking adalimumab or other TNF α blockers. People with more serious rheumatoid arthritis who have had the disease for a long time may have a higher than average risk of getting lymphoma and leukaemia (cancers that affect blood cells and bone marrow). If you take Hyrimoz the risk of getting lymphoma, leukaemia, or other cancers may increase. On rare occasions, a specific and severe type of lymphoma has been observed in patients taking adalimumab. Some of those patients were also treated with the medicines azathioprine or mercaptopurine. Tell your doctor if you are taking azathioprine or mercaptopurine with Hyrimoz.
- In addition cases of non-melanoma skin cancer have been observed in patients taking adalimumab. If new areas of damaged skin appear during or after treatment or if existing marks or areas of damage change appearance, tell your doctor.
- There have been cases of cancers, other than lymphoma, in patients with a specific type of lung disease called chronic obstructive pulmonary disease (COPD) treated with another TNF α blocker. If you have COPD, or are a heavy smoker, you should discuss with your doctor whether treatment with a TNF α blocker is appropriate for you.

Autoimmune diseases

- On rare occasions, treatment with Hyrimoz could result in lupus-like syndrome. Contact your doctor, if symptoms such as persistent unexplained rash, fever, joint pain or tiredness occur.

Children and adolescents

- Vaccinations: if possible, children should be up to date with all vaccinations before using Hyrimoz.

Other medicines and Hyrimoz

Tell your doctor or pharmacist if you are taking, have recently taken or might take any other medicines.

Hyrimoz can be taken together with methotrexate or certain disease-modifying anti-rheumatic agents (sulfasalazine, hydroxychloroquine, leflunomide and injectable gold preparations), corticosteroids or pain medications including non-steroidal anti-inflammatory drugs (NSAIDs).

You should not take Hyrimoz with medicines containing the active substances anakinra or abatacept

due to increased risk of serious infection. The combination of adalimumab as well as other TNF-antagonists and anakinra or abatacept is not recommended based upon the possible increased risk for infections, including serious infections and other potential pharmacological interactions. If you have questions, please ask your doctor.

Pregnancy and breast-feeding

- You should consider the use of adequate contraception to prevent pregnancy and continue its use for at least 5 months after the last Hyrimoz treatment.
- If you are pregnant, think you may be pregnant or are planning to have a baby, ask your doctor for advice before taking this medicine.
- Hyrimoz should only be used during a pregnancy if needed.
- According to a pregnancy study, there was no higher risk of birth defects when the mother had received adalimumab during pregnancy compared with mothers with the same disease who did not receive adalimumab.
- Hyrimoz can be used during breast-feeding.
- If you receive Hyrimoz during your pregnancy, your baby may have a higher risk for getting an infection.
- It is important that you tell your baby's doctors and other health care professionals about your Hyrimoz use during your pregnancy before the baby receives any vaccine (for more information on vaccines see the "Warnings and precautions" section).

Driving and using machines

Hyrimoz may have a minor influence on your ability to drive, cycle or use machines. Room spinning sensation (vertigo) and vision disturbances may occur after taking Hyrimoz.

Hyrimoz contains sodium

This medicine contains less than 1 mmol of sodium (23 mg) per 0.8 ml dose, that is to say essentially 'sodium-free'.

3. How to use Hyrimoz

Always use this medicine exactly as your doctor or pharmacist has told you. Check with your doctor or pharmacist if you are not sure.

The recommended doses for Hyrimoz in each of the approved uses are shown in the following table. Your doctor may prescribe another strength of Hyrimoz if you need a different dose.

Rheumatoid arthritis, psoriatic arthritis, ankylosing spondylitis or axial spondyloarthritis without radiographic evidence of ankylosing spondylitis		
Age or body weight	How much and how often to take?	Notes
Adults	40 mg every other week as a single dose.	In rheumatoid arthritis, methotrexate is continued while using Hyrimoz. If your doctor determines that methotrexate is inappropriate, Hyrimoz can be given alone. If you have rheumatoid arthritis and you do not receive methotrexate with your Hyrimoz therapy, your doctor may decide to give 40 mg Hyrimoz every week or 80 mg every other week.

Plaque Psoriasis		
Age or body weight	How much and how often to take?	Notes
Adults	First dose of 80 mg (one 80 mg injection), followed by 40 mg given every other week starting one week after the first dose.	You should continue to inject Hyrimoz for as long as your doctor has told you. If this dose does not work well enough, your doctor may increase the dose to 40 mg every week or 80 mg every other week.

Hidradenitis suppurativa		
Age or body weight	How much and how often to take?	Notes
Adults	First dose of 160 mg (two 80 mg injections in one day or one 80 mg injection per day for two consecutive days), followed by an 80 mg dose (one 80 mg injection) two weeks later. After two further weeks, continue with a dose of 40 mg every week or 80 mg every other week, as prescribed by your doctor.	It is recommended that you use an antiseptic wash daily on the affected areas.
Adolescents from 12 to 17 years of age weighing 30 kg or more	First dose of 80 mg (one 80 mg injection), followed by 40 mg every other week starting one week later.	If this dose does not work well enough, your doctor may increase the dose to 40 mg every week or 80 mg every other week. It is recommended that you use an antiseptic wash daily on the affected areas.

Crohn's disease		
Age or body weight	How much and how often to take?	Notes
Children, adolescents and adults weighing 40 kg or more	<p>First dose of 80 mg (one 80 mg injections), followed by 40 mg every other week starting two weeks later.</p> <p>If a faster response is required your doctor may prescribe a first dose of 160 mg (two 80 mg injections in one day or one 80 mg injection per day for two consecutive days), followed by 80 mg (one 80 mg injection) two weeks later.</p> <p>Thereafter the usual dose is 40 mg every other week.</p>	If this dose does not work well enough, your doctor may increase the dose to 40 mg every week or 80 mg every other week.

Paediatric Crohn's disease		
Age or body weight	How much and how often to take?	Notes
Children and adolescents from 6 to 17 years of age weighing less than 40 kg	<p>First dose of 40 mg, followed by 20 mg every other week starting two weeks later.</p> <p>If a faster response is required, your doctor may prescribe a first dose of 80 mg (one 80 mg injections), followed by 40 mg two weeks later.</p> <p>Thereafter the usual dose is 20 mg every other week.</p>	If this dose does not work well enough, your child's doctor may increase the dose frequency to 20 mg every week.

Ulcerative colitis		
Age or body weight	How much and how often to take?	Notes
Adults	<p>First dose is 160 mg (two 80 mg injections in one day or as one 80 mg injection per day for two consecutive days), followed by 80 mg (one 80 mg injection) two weeks later.</p> <p>Thereafter, the usual dose is 40 mg every other week.</p>	If this dose does not work well enough, your doctor may increase the dose to 40 mg every week or 80 mg every other week.

Paediatric ulcerative colitis		
Age and body weight	How much and how often to take?	Notes
Children and adolescents from 6 years of age weighing 40 kg or more	<p>First dose is 160 mg (two 80 mg injections in one day or one 80 mg injection per day for two consecutive days) initially,</p>	Patients who turn 18 years of age while on 80 mg every other week, should continue their prescribed dose.

	followed by 80 mg (one 80 mg injection) two weeks later. Thereafter the usual dose is 80 mg every other week.	
Children and adolescents from 6 years of age weighing less than 40 kg	First dose is 80 mg (one 80 mg injection) initially followed by 40 mg (as one 40 mg injection) two weeks later. Thereafter, the usual dose is 40 mg every other week.	Patients who turn 18 years of age while on 40 mg every other week, should continue their prescribed dose.

Non-infectious uveitis		
Age or body weight	How much and how often to take?	Notes
Adults	First dose of 80 mg (one 80 mg injection), followed by 40 mg every other week starting one week after the first dose.	In non-infectious uveitis, corticosteroids or other medicines that influence the immune system may be continued while using Hyrimoz. Hyrimoz can also be given alone. You should continue to inject Hyrimoz for as long as your doctor has told you.
Children and adolescents from 2 years of age weighing 30 kg or more	40 mg every other week.	Your doctor may also prescribe a first dose of 80 mg which may be administered one week prior to the start of the usual dose of 40mg every other week. Hyrimoz is recommended for the use in combination with methotrexate.
Children and adolescents from 2 years of age weighing less than 30 kg	20 mg every other week.	Your doctor may also prescribe a first dose of 40 mg which may be administered one week prior to the start of the usual dose of 20 mg every other week. Hyrimoz is recommended for the use in combination with methotrexate.

Method and route of administration

Hyrimoz is administered by injection under the skin (by subcutaneous injection).

Detailed instructions on how to inject Hyrimoz are provided in section 7, “**Instructions for use**”.

If you use more Hyrimoz than you should

If you accidentally inject Hyrimoz more frequently than you should, call your doctor or pharmacist and explain that you have taken more than required. Always take the outer carton of medicine with you, even if it is empty.

If you forget to use Hyrimoz

If you forget to give yourself an injection, you should inject the next dose of Hyrimoz as soon as you remember. Then take your next dose as you would have on your originally scheduled day, had you not forgotten a dose.

If you stop using Hyrimoz

The decision to stop using Hyrimoz should be discussed with your doctor. Your symptoms may return upon stopping treatment.

If you have any further questions on the use of this medicine, ask your doctor or pharmacist.

4. Possible side effects

Like all medicines, this medicine can cause side effects, although not everybody gets them. Most side effects are mild to moderate. However, some may be serious and require treatment. Side effects may occur up to 4 months or more after the last Hyrimoz injection.

Seek medical attention urgently, if you notice any of the following signs of allergic reaction or heart failure:

- severe rash, hives;
- swollen face, hands, feet;
- trouble breathing, swallowing;
- shortness of breath with physical activity or upon lying down or swelling of the feet.

Tell your doctor as soon as possible, if you notice any of the following:

- signs and symptoms of infection such as fever, feeling sick, wounds, dental problems, burning on urination, feeling weak or tired or coughing;
- symptoms of nerve problems such as tingling, numbness, double vision or arm or leg weakness;
- signs of skin cancer such as a bump or open sore that doesn't heal;
- signs and symptoms suggestive of blood disorders such as persistent fever, bruising, bleeding, paleness.

The following side effects have been observed with adalimumab:

Very common (may affect more than 1 in 10 people)

- injection site reactions (including pain, swelling, redness or itching);
- respiratory tract infections (including cold, runny nose, sinus infection, pneumonia);
- headache;
- abdominal (belly) pain;
- nausea and vomiting;
- rash;
- pain in the muscles.

Common (may affect up to 1 in 10 people)

- serious infections (including blood poisoning and influenza);
- intestinal infections (including gastroenteritis);
- skin infections (including cellulitis and shingles);
- ear infections;

- mouth infections (including tooth infections and cold sores);
- reproductive tract infections;
- urinary tract infection;
- fungal infections;
- joint infections;
- benign tumours;
- skin cancer;
- allergic reactions (including seasonal allergy);
- dehydration;
- mood swings (including depression);
- anxiety;
- difficulty sleeping;
- sensation disorders such as tingling, prickling or numbness;
- migraine;
- symptoms of nerve root compression (including low back pain and leg pain);
- vision disturbances;
- eye inflammation;
- inflammation of the eye lid and eye swelling;
- vertigo (sensation of room spinning);
- sensation of heart beating rapidly;
- high blood pressure;
- flushing;
- haematoma (a solid swelling with clotted blood);
- cough;
- asthma;
- shortness of breath;
- gastrointestinal bleeding;
- dyspepsia (indigestion, bloating, heart burn);
- acid reflux disease;
- sicca syndrome (including dry eyes and dry mouth);
- itching;
- itchy rash;
- bruising;
- inflammation of the skin (such as eczema);
- breaking of finger nails and toe nails;
- increased sweating;
- hair loss;
- new onset or worsening of psoriasis;
- muscle spasms;
- blood in urine;
- kidney problems;
- chest pain;
- oedema (a build-up of fluid in the body which causes the affected tissue to swell);
- fever;
- reduction in blood platelets which increases risk of bleeding or bruising;
- impaired healing.

Uncommon (may affect up to 1 in 100 people)

- unusual infections (which include tuberculosis and other infections) that occur when resistance to disease is lowered;
- neurological infections (including viral meningitis);
- eye infections;
- bacterial infections;

- diverticulitis (inflammation and infection of the large intestine);
- cancer, including cancer that affects the lymph system (lymphoma) and melanoma (a type of skin cancer);
- immune disorders that could affect the lungs, skin and lymph nodes (most commonly as a condition called sarcoidosis);
- vasculitis (inflammation of blood vessels);
- tremor (shaking);
- neuropathy (nerve damage);
- stroke;
- hearing loss, buzzing;
- sensation of heart beating irregularly such as skipped beats;
- heart problems that can cause shortness of breath or ankle swelling;
- heart attack;
- a sac in the wall of a major artery, inflammation and clot of a vein; blockage of a blood vessel;
- lung diseases causing shortness of breath (including inflammation);
- pulmonary embolism (blockage in an artery of the lung);
- pleural effusion (abnormal collection of fluid in the pleural space);
- inflammation of the pancreas which causes severe pain in the abdomen and back;
- difficulty in swallowing;
- facial oedema (swelling);
- gallbladder inflammation, gallbladder stones;
- fatty liver (build-up of fat in liver cells);
- night sweats;
- scar;
- abnormal muscle breakdown;
- systemic lupus erythematosus (an immune disorder including inflammation of skin, heart, lung, joints and other organ systems);
- sleep interruptions;
- impotence;
- inflammations.

Rare (may affect up to 1 in 1 000 people)

- leukaemia (cancer affecting the blood and bone marrow);
- severe allergic reaction with shock;
- multiple sclerosis;
- nerve disorders (such as inflammation of the optic nerve to the eye, and Guillain-Barré syndrome, a condition that may cause muscle weakness, abnormal sensations, tingling in the arms and upper body);
- heart stops pumping;
- pulmonary fibrosis (scarring of the lung);
- intestinal perforation (hole in the wall of the gut);
- hepatitis (liver inflammation);
- reactivation of hepatitis B infection;
- autoimmune hepatitis (inflammation of the liver caused by the body's own immune system);
- cutaneous vasculitis (inflammation of blood vessels in the skin);
- Stevens-Johnson syndrome (life-threatening reaction with flu-like symptoms and blistering rash);
- facial oedema (swelling) associated with allergic reactions;
- erythema multiforme (inflammatory skin rash);
- lupus-like syndrome;
- angioedema (localised swelling of the skin);
- lichenoid skin reaction (itchy reddish-purple skin rash).

Not known (frequency cannot be estimated from available data)

- hepatosplenic T-cell lymphoma (a rare blood cancer that is often fatal);
- Merkel cell carcinoma (a type of skin cancer);
- Kaposi's sarcoma, a rare cancer related to infection with human herpes virus 8. Kaposi's sarcoma most commonly appears as purple lesions on the skin;
- liver failure;
- worsening of a condition called dermatomyositis (seen as a skin rash accompanying muscle weakness).
- weight gain (for most patients, the weight gain was small)

Some side effects observed with adalimumab may not have symptoms and may only be discovered through blood tests. These include:

Very common (may affect more than 1 in 10 people)

- low blood measurements for white blood cells;
- low blood measurements for red blood cells;
- increased lipids in the blood;
- raised liver enzymes.

Common (may affect up to 1 in 10 people)

- high blood measurements for white blood cells;
- low blood measurements for platelets;
- increased uric acid in the blood;
- abnormal blood measurements for sodium;
- low blood measurements for calcium;
- low blood measurements for phosphate;
- high blood sugar;
- high blood measurements for lactate dehydrogenase;
- autoantibodies present in the blood;
- low blood potassium.

Uncommon (may affect up to 1 in 100 people)

- raised bilirubin measurement (liver blood test).

Rare (may affect up to 1 in 1 000 people)

- low blood measurements for white blood cells, red blood cells and platelet count.

Reporting of side effects

If you get any side effects, talk to your doctor or pharmacist. This includes any possible side effects not listed in this leaflet. You can also report side effects directly via **the national reporting system** listed in [Appendix V](#). By reporting side effects, you can help provide more information on the safety of this medicine.

5. How to store Hyrimoz

Keep this medicine out of the sight and reach of children.

Do not use this medicine after the expiry date which is stated on the label/blister/carton after EXP. The expiry date refers to the last day of that month.

Store in a refrigerator (2°C–8°C). Do not freeze.

Keep the pre-filled syringe in the outer carton in order to protect from light.

Alternative Storage:

When needed (for example when you are travelling), Hyrimoz may be stored at room temperature (up to 25°C) for a maximum period of 42 days – be sure to protect it from light. Once removed from the refrigerator for room temperature storage, your pre-filled syringe **must be used within 42 days or discarded**, even if it is later returned to the refrigerator. You should record the date when your pre-filled syringe is first removed from the refrigerator, and the date after which it should be discarded.

Do not throw away any medicines via wastewater or household waste. Ask your pharmacist how to throw away medicines you no longer use. These measures will help protect the environment.

6. Contents of the pack and other information

What Hyrimoz contains

- The active substance is adalimumab. Each pre-filled syringe contains 80 mg of adalimumab in 0.8 ml of solution.
- The other ingredients are adipic acid, mannitol (E 421), polysorbate 80 (E 433), hydrochloric acid (E 507), sodium hydroxide (E 524) and water for injections (see section 2 “Hyrimoz contains sodium”).

What Hyrimoz looks like and contents of the pack

Hyrimoz 80 mg solution for injection (injection) in pre-filled syringe is supplied as a 0.8 ml clear to slightly opalescent, colourless or slightly yellowish solution.

Hyrimoz is supplied in a single-use clear type I glass syringe with a stainless steel 29 gauge needle with a needle guard with finger flange, rubber needle cap (thermoplastic elastomer) and plastic plunger rod, containing 0.8 ml of solution.

Cartons contain 1 and 2 pre-filled syringes of Hyrimoz.

Not all pack sizes may be marketed.

Hyrimoz is available as a pre-filled syringe and a pre-filled pen.

Marketing Authorisation Holder

Sandoz GmbH
Biochemiestr. 10
6250 Kundl
Austria

Manufacturer

Sandoz GmbH Schafftenau
Biochemiestr. 10
6336 Langkampfen
Austria

Novartis Pharmaceutical Manufacturing GmbH
Biochemiestrasse 10
6336 Langkampfen
Austria

For any information about this medicine, please contact the local representative of the Marketing Authorisation Holder:

België/Belgique/Belgien

Sandoz nv/sa
Tél/Tel: +32 2 722 97 97

България

Сандоз България КЧТ
Тел.: +359 2 970 47 47

Česká republika

Sandoz s.r.o.
Tel: +420 225 775 111

Danmark/Norge/Ísland/Sverige

Sandoz A/S
Tlf./Sími/Tel: +45 63 95 10 00

Deutschland

Hexal AG
Tel: +49 8024 908 0

Eesti

Sandoz d.d. Eesti filiaal
Tel: +372 665 2400

Ελλάδα

SANDOZ HELLAS MONOΠΡΟΣΩΠΗ Α.Ε.
Τηλ: +30 216 600 5000

España

Sandoz Farmacéutica, S.A.
Tel: +34 900 456 856

France

Sandoz SAS
Tél: +33 1 49 64 48 00

Hrvatska

Sandoz d.o.o.
Tel: +385 1 23 53 111

Ireland

Rowex Ltd.
Tel: + 353 27 50077

Italia

Sandoz S.p.A.
Tel: +39 02 96541

Lietuva

Sandoz Pharmaceuticals d.d filialas
Tel: +370 5 2636 037

Luxembourg/Luxemburg

Sandoz nv/sa (Belgique/Belgien)
Tél/Tel.: +32 2 722 97 97

Magyarország

Sandoz Hungária Kft.
Tel.: +36 1 430 2890

Malta

Sandoz Pharmaceuticals d.d.
Tel: +356 99644126

Nederland

Sandoz B.V.
Tel: +31 36 52 41 600

Österreich

Sandoz GmbH
Tel: +43 5338 2000

Polska

Sandoz Polska Sp. z o.o.
Tel.: +48 22 209 70 00

Portugal

Sandoz Farmacêutica Lda.
Tel: +351 21 000 86 00

România

Sandoz Pharmaceuticals SRL
Tel: +40 21 407 51 60

Slovenija

Sandoz farmacevtska družba d.d.
Tel: +386 1 580 29 02

Slovenská republika

Sandoz d.d. - organizačná zložka
Tel: +421 2 48 200 600

Suomi/Finland

Sandoz A/S
Puh/Tel: +358 10 6133 400

Κύπρος
SANDOZ HELLAS MONOΠΡΟΣΩΠΗ Α.Ε.
(Ελλάδα)
Τηλ: +30 216 600 5000

Latvija
Sandoz d.d. Latvia filiāle
Tel: +371 67 892 006

United Kingdom (Northern Ireland)
Sandoz GmbH
Tel: +43 5338 2000

This leaflet was last revised in

Other sources of information

Detailed information on this medicine is available on the European Medicines Agency web site:
<https://www.ema.europa.eu>.

7. Instructions for use

To help avoid possible infections and to ensure that you use the medicine correctly, it is important that you follow these instructions.

Be sure that you read, understand, and follow these Instructions for Use before injecting Hyrimoz. Your healthcare provider should show you how to prepare and inject Hyrimoz properly using the single-dose pre-filled syringe before you use it for the first time. Talk to your healthcare provider if you have any questions.

Your Hyrimoz single-use pre-filled syringe with needle guard and add-on finger flange

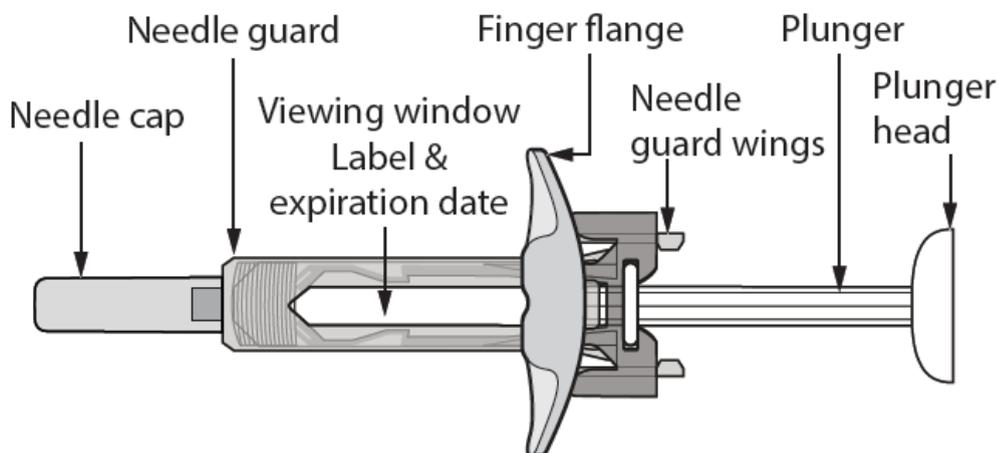

Figure A: Hyrimoz pre-filled syringe with needle guard and finger flange

It is important that you:

- **do not use** the pre-filled syringe if the seals of the blister are broken, as it may not be safe for you to use
- **do not open** the outer box until you are ready to use the pre-filled syringe.
- **never leave** the pre-filled syringe unattended where others might tamper with it.
- if you drop your syringe, **do not use** it if it looks damaged, or if you dropped it with the needle cap removed.
- **do not remove** the needle cap until just before you give the injection.
- **be careful not to touch the needle guard wings** before use. Touching them may cause the needle guard to be activated too early.
- **do not remove** the finger flange before the injection.
- **inject** Hyrimoz 15–30 minutes after taking it out of the refrigerator for a more comfortable injection.
- throw away the used syringe right away after use. **Do not re-use a pre-filled syringe.** See “4. Disposing of used pre-filled syringes” at the end of these Instructions for Use.

How should you store Hyrimoz single-dose pre-filled syringe?

- Store your outer carton of pre-filled syringes in a refrigerator, between 2°C to 8°C.
- When needed (for example when you are travelling), Hyrimoz may be stored at room temperature (up to 25°C) for a maximum period of 42 days – be sure to protect it from light. Once removed from the refrigerator for room temperature storage, your pre-filled syringe **must be used within 42 days or discarded**, even if it is later returned to the refrigerator. You should record the date when your pre-filled syringe is first removed from the refrigerator, and the date after which it should be discarded.
- Keep your pre-filled syringes in the original carton until ready to use to protect from light.
- Do not store the pre-filled syringes in extreme heat or cold.
- Do not freeze the pre-filled syringes.

Keep Hyrimoz and all medicines out of the reach of children.

What do you need for your injection?

Place the following items on a clean, flat surface.

Included in your pre-filled syringe carton are:

- Hyrimoz pre-filled syringe/s (see **Figure A**). Each pre-filled syringe contains 80 mg/0.8 ml of adalimumab.

Not included in your HYRIMOZ pre-filled syringe carton are (see **Figure B**):

- Alcohol wipe
- Cotton ball or gauze
- Sharps disposal container. See “4. Disposing of used pre-filled syringes” at the end of this Instructions for Use.
- Adhesive bandage

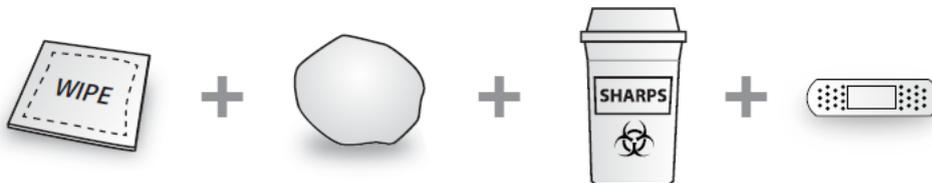

Figure B: items **not** included in the carton

Before your injection

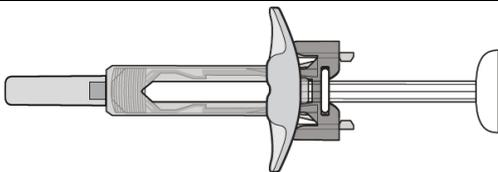

Figure C: needle guard is not activated – the single-dose pre-filled syringe is ready for use

- In this configuration the needle guard is **not activated**.
- The syringe is ready for use (see **Figure C**).

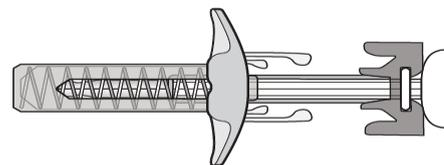

Figure D: needle guard is activated – **do not use**

- In this configuration the needle guard of your pre-filled syringe is **activated**.
- **Do not use** the syringe (see **Figure D**).

Preparing the syringe

- For a more comfortable injection, take the carton containing the pre-filled syringe out of the refrigerator and leave it **unopened** on your work surface for about 15 to 30 minutes to allow it to reach room temperature.
- Take the pre-filled syringe out of the blister.
- Look through the viewing window. The solution should be colourless or slightly yellowish as well as clear to slightly opalescent. Do not use if any particulates and/or discolorations are observed. If you are concerned with the appearance of the solution, then contact your pharmacist for assistance.
- **Do not use** the pre-filled syringe if it is broken or the needle guard is activated. Return the pre-filled syringe and the package it came in to the pharmacy.
- Look at the expiry date (EXP) on your pre-filled syringe. Do not use your pre-filled syringe if the expiry date has passed.

Contact your pharmacist if the syringe fails any of the above mentioned checks.

1. Choosing your injection site:

- The recommended injection site is the front of your thighs. You may also use the lower abdomen, but not the area 5 cm around your navel (belly button) (see *Figure E*).
- Choose a different site each time you give yourself an injection.
- **Do not** inject into areas where the skin is tender, bruised, red, scaly, or hard. Avoid areas with scars or stretch marks. If you have psoriasis, you should NOT inject directly into areas with psoriasis plaques.

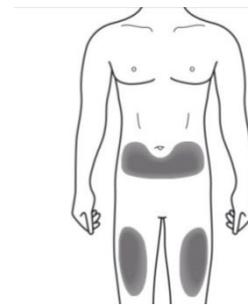

Figure E: choose your injection site

2. Cleaning your injection site:

- Wash your hands well with soap and water.
- Using a circular motion, clean the injection site with an alcohol wipe. Let it dry before injecting (see *Figure F*).
- **Do not** touch the cleaned area before injecting.

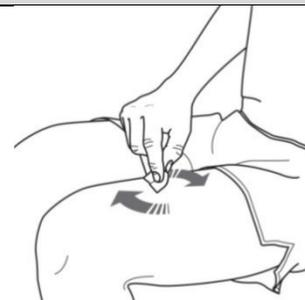
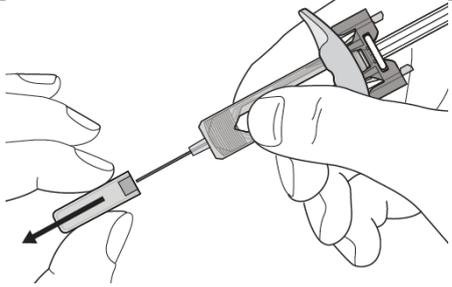
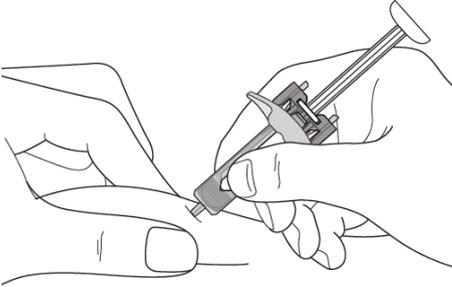
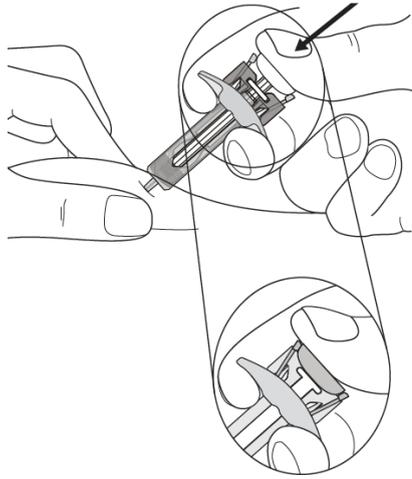
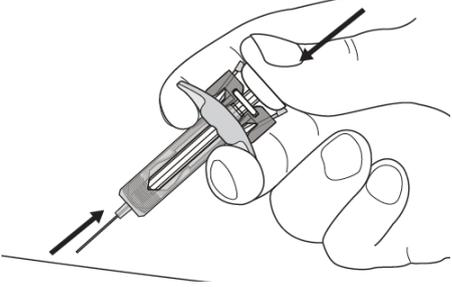

Figure F: clean your injection site

<p>3. Giving your injection:</p> <ul style="list-style-type: none"> Carefully pull the needle cap straight off to remove it from the pre-filled syringe (see Figure G). Discard the needle cap. You may see a drop of liquid at the end of the needle. This is normal. 	 <p>Figure G: pull the needle cap off</p>
<ul style="list-style-type: none"> Gently pinch the skin at the injection site (see Figure H). Insert the needle into your skin as shown. Push the needle all the way in to ensure that the medicine can be fully administered. Use your syringe within 5 minutes of removing the cap 	 <p>Figure H: insert the needle</p>
<ul style="list-style-type: none"> Hold the pre-filled syringe as shown (see Figure I). Slowly press down on the plunger as far as it will go, so that the plunger head is completely between the needle guard wings. Keep the plunger pressed fully down while you hold the syringe in place for 5 seconds. 	 <p>Figure I: hold the syringe</p>
<ul style="list-style-type: none"> Keep the plunger fully pressed down while you carefully lift the needle straight out from the injection site and let go of your skin (see Figure J). 	 <p>Figure J: lift the needle straight out</p>

- Slowly release the plunger and allow the needle safety guard to automatically cover the exposed needle (see *Figure K*).
- There may be a small amount of blood at the injection site. You can press a cotton ball or gauze onto the injection site and hold it for 10 seconds. Do not rub the injection site. You may cover the injection site with a small adhesive bandage, if needed.

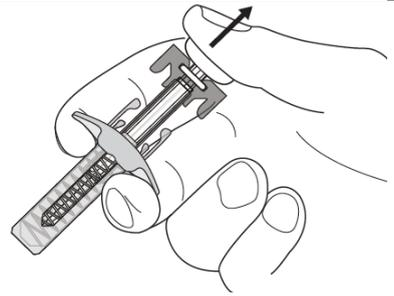

Figure K: slowly release the plunger

4. Disposing of used syringes:

- Dispose of the used syringe in a sharps container (closable, puncture-resistant container, see *Figure L*). For the safety and health of you and others, needles and used syringes must never be re-used.
- Do not throw away any medicines via wastewater or household waste. Ask your doctor or pharmacist how to throw away medicines you no longer use. These measures will help protect the environment. Any unused product or waste material should be disposed of in accordance with local requirements.



Figure L: dispose of your used syringe

If you have any questions, please talk to a doctor, pharmacist or nurse who is familiar with Hyrimoz

Package leaflet: Information for the patient

Hyrimoz 80 mg solution for injection in pre-filled pen adalimumab

Read all of this leaflet carefully before you start using this medicine because it contains important information for you.

- Keep this leaflet. You may need to read it again.
- Your doctor will also give you a **Patient Reminder Card**, which contains important safety information that you need to be aware of before you are given Hyrimoz and during treatment with Hyrimoz. Keep this **Patient Reminder Card** with you during your treatment and for 4 months after your (or your child's) last injection of Hyrimoz.
- If you have any further questions, please ask your doctor or pharmacist.
- This medicine has been prescribed for you only. Do not pass it on to others. It may harm them, even if their signs of illness are the same as yours.
- If you get any side effects, talk to your doctor or pharmacist. This includes any possible side effects not listed in this leaflet. See section 4.

What is in this leaflet

1. What Hyrimoz is and what it is used for
2. What you need to know before you use Hyrimoz
3. How to use Hyrimoz
4. Possible side effects
5. How to store Hyrimoz
6. Contents of the pack and other information
7. Instructions for use

1. What Hyrimoz is and what it is used for

Hyrimoz contains the active substance adalimumab, a medicine that acts on your body's immune (defence) system.

Hyrimoz is intended for the treatment of the following inflammatory diseases:

- rheumatoid arthritis,
- plaque psoriasis,
- hidradenitis suppurativa,
- Crohn's disease,
- ulcerative colitis,
- non-infectious uveitis.

The active substance in Hyrimoz, adalimumab, is a monoclonal antibody. Monoclonal antibodies are proteins that attach to a specific target in the body.

The target of adalimumab is another protein called tumour necrosis factor (TNF α), which is present at increased levels in the inflammatory diseases listed above. By attaching to TNF α , Hyrimoz blocks its action and reduces the inflammation in these diseases.

Rheumatoid arthritis

Rheumatoid arthritis is an inflammatory disease of the joints.

Hyrimoz is used to treat rheumatoid arthritis in adults. If you have moderate to severe active rheumatoid arthritis, you may first be given other disease-modifying medicines, such as methotrexate. If these medicines do not work well enough, you will be given Hyrimoz to treat your rheumatoid

arthritis.

Hyrimoz can also be used to treat severe, active and progressive rheumatoid arthritis without previous methotrexate treatment.

Hyrimoz can slow down the damage to the cartilage and bone of the joints caused by the disease and improve physical function.

Usually, Hyrimoz is used with methotrexate. If your doctor considers that methotrexate is inappropriate, Hyrimoz can be given alone.

Plaque psoriasis

Plaque psoriasis is an inflammatory skin condition that causes red, flaky, crusty patches of skin covered with silvery scales. Plaque psoriasis can also affect the nails, causing them to crumble, become thickened and lift away from the nail bed which can be painful. Psoriasis is believed to be caused by a problem with the body's immune system that leads to an increased production of skin cells.

Hyrimoz is used to treat moderate to severe plaque psoriasis in adults.

Hidradenitis suppurativa in adults and adolescents

Hidradenitis suppurativa (sometimes called acne inversa) is a long-term and often painful inflammatory skin disease. Symptoms may include tender nodules (lumps) and abscesses (boils) that may leak pus.

It most commonly affects specific areas of the skin, such as under the breasts, the armpits, inner thighs, groin and buttocks. Scarring may also occur in affected areas.

Hyrimoz is used to treat

- moderate to severe hidradenitis suppurativa in adults and
- moderate to severe hidradenitis suppurativa in adolescents aged 12 to 17 years.

Hyrimoz can reduce the number of nodules and abscesses you have, and the pain that is often associated with the disease. You may first be given other medicines. If these medicines do not work well enough, you will be given Hyrimoz.

Crohn's disease in adults and children

Crohn's disease is an inflammatory disease of the gut.

Hyrimoz is used to treat

- moderate to severe Crohn's disease in adults and
- moderate to severe Crohn's disease in children and adolescents aged 6 to 17 years.

If you have Crohn's disease you will first be given other medicines. If you do not respond well enough to these medicines, you will be given Hyrimoz to reduce the signs and symptoms of your Crohn's disease.

Ulcerative colitis in adults and children

Ulcerative colitis is an inflammatory disease of large intestine.

Hyrimoz is used to treat

- moderate to severe ulcerative colitis in adults and
- moderate to severe ulcerative colitis in children and adolescents aged 6 to 17 years.

If you have ulcerative colitis you may first be given other medicines. If these medicines do not work well enough, you will be given Hyrimoz to reduce the signs and symptoms of your disease.

Non-infectious uveitis in adults and children

Non-infectious uveitis is an inflammatory disease affecting certain parts of the eye. The inflammation leads to a decrease of vision and/or the presence of floaters in the eye (black dots or wispy lines that move across the field of vision). Hyrimoz works by reducing this inflammation.

Hyrimoz is used to treat

- adults with non-infectious uveitis with inflammation affecting the back of the eye.
- children from 2 years of age with chronic non-infectious uveitis with inflammation affecting the front of the eye.

You may first be given other medicines. If you do not respond well enough to these medicines, you will be given Hyrimoz.

2. What you need to know before you use Hyrimoz

Do not use Hyrimoz

- if you are allergic to adalimumab or any of the other ingredients of this medicine (listed in section 6).
- if you have a severe infection, including tuberculosis, sepsis (blood poisoning) or other opportunistic infections (unusual infections associated with a weakened immune system). It is important that you tell your doctor if you have symptoms of infections, e.g. fever, wounds, feeling tired, dental problems (see “Warnings and precautions”).
- if you have moderate or severe heart failure. It is important to tell your doctor if you have had or have a serious heart condition (see “Warnings and precautions”).

Warnings and precautions

Talk to your doctor or pharmacist before using Hyrimoz.

Allergic reaction

- If you have allergic reactions with symptoms such as chest tightness, wheezing, dizziness, swelling or rash, do not inject more Hyrimoz and contact your doctor immediately, since in rare cases, these reactions can be life-threatening.

Infections

- If you have an infection, including long-term or localised infection (for example leg ulcer), consult your doctor before starting Hyrimoz. If you are unsure, contact your doctor.
- You might get infections more easily while you are receiving Hyrimoz treatment. This risk may increase if your lung function is reduced. These infections may be more serious and include tuberculosis, infections caused by viruses, fungi, parasites or bacteria, or other unusual infectious organisms and sepsis (blood poisoning).
- In rare cases, these infections may be life-threatening. It is important to tell your doctor if you get symptoms such as fever, wounds, feeling tired or dental problems. Your doctor may recommend temporarily stopping Hyrimoz.

Tuberculosis (TB)

- As cases of tuberculosis have been reported in patients treated with adalimumab, your doctor will check you for signs and symptoms of tuberculosis before starting Hyrimoz. This will include a thorough medical evaluation including your medical history and screening tests (for example chest X-ray and a tuberculin test). The conduct and results of these tests should be recorded on your **Patient Reminder Card**. It is very important that you tell your doctor if you have ever had tuberculosis, or if you have been in close contact with someone who has had tuberculosis. Tuberculosis can develop during therapy even if you have had preventative treatment for tuberculosis. If symptoms of tuberculosis (persistent cough, weight loss, lack of energy, mild fever), or any other infection appear during or after therapy tell your doctor immediately.

Travel/recurrent infection

- Tell your doctor if you have lived or travelled in regions where fungal infections such as histoplasmosis, coccidioidomycosis or blastomycosis are very common.
- Tell your doctor if you have a history of recurrent infections or other conditions that increase the risk of infections.

Hepatitis B virus

- Tell your doctor if you are a carrier of the hepatitis B virus (HBV), if you have active HBV infection or if you think you might be at risk of getting HBV. Your doctor should test you for HBV. Adalimumab can reactivate HBV infection in people who carry this virus. In some rare cases, especially if you are taking other medicines that suppress the immune system, reactivation of HBV infection can be life-threatening.

Age over 65 years

- If you are over 65 years you may be more susceptible to infections while taking Hyrimoz. You and your doctor should pay special attention to signs of infection while you are being treated with Hyrimoz. It is important to tell your doctor if you get symptoms of infections, such as fever, wounds, feeling tired or dental problems.

Surgery or dental procedures

- If you are about to have surgery or dental procedures tell your doctor that you are taking Hyrimoz. Your doctor may recommend temporarily stopping Hyrimoz.

Demyelinating disease

- If you have or develop demyelinating disease (a disease that affects the insulating layer around the nerves, such as multiple sclerosis), your doctor will decide if you should receive or continue to receive Hyrimoz. Tell your doctor immediately if you get symptoms like changes in your vision, weakness in your arms or legs or numbness or tingling in any part of your body.

Vaccine

- Certain vaccines contain living but weakened forms of disease-causing bacteria or viruses and should not be given during treatment with Hyrimoz in case they cause infections. Check with your doctor before you receive any vaccines. It is recommended that, if possible, children be given all the scheduled vaccinations for their age before they start treatment with Hyrimoz.

If you receive Hyrimoz while you are pregnant, your baby may be at higher risk for getting an infection for up to about five months after the last dose you received during pregnancy. It is important that you tell your baby's doctors and other health care professionals about your

Hyrimoz use during your pregnancy so they can decide when your baby should receive any vaccine.

Heart failure

- It is important to tell your doctor if you have had or have a serious heart condition. If you have mild heart failure and you are being treated with Hyrimoz, your heart failure status must be closely monitored by your doctor. If you develop new or worsening symptoms of heart failure (e.g. shortness of breath, or swelling of your feet), you must contact your doctor immediately.

Fever, bruising, bleeding or looking pale

- In some patients the body may fail to produce enough of the blood cells that fight off infections or help you to stop bleeding. If you develop a fever that does not go away, or you bruise or bleed very easily or look very pale, call your doctor right away. Your doctor may decide to stop treatment.

Cancer

- There have been very rare cases of certain kinds of cancer in children and adults taking adalimumab or other TNF α blockers. People with more serious rheumatoid arthritis who have had the disease for a long time may have a higher than average risk of getting lymphoma and leukaemia (cancers that affect blood cells and bone marrow). If you take Hyrimoz the risk of getting lymphoma, leukaemia, or other cancers may increase. On rare occasions, a specific and severe type of lymphoma has been observed in patients taking adalimumab. Some of those patients were also treated with the medicines azathioprine or mercaptopurine. Tell your doctor if you are taking azathioprine or mercaptopurine with Hyrimoz.
- In addition cases of non-melanoma skin cancer have been observed in patients taking adalimumab. If new areas of damaged skin appear during or after treatment or if existing marks or areas of damage change appearance, tell your doctor.
- There have been cases of cancers, other than lymphoma, in patients with a specific type of lung disease called chronic obstructive pulmonary disease (COPD) treated with another TNF α blocker. If you have COPD, or are a heavy smoker, you should discuss with your doctor whether treatment with a TNF α blocker is appropriate for you.

Autoimmune diseases

- On rare occasions, treatment with Hyrimoz could result in lupus-like syndrome. Contact your doctor, if symptoms such as persistent unexplained rash, fever, joint pain or tiredness occur.

Children and adolescents

- Vaccinations: if possible, children should be up to date with all vaccinations before using Hyrimoz.

Other medicines and Hyrimoz

Tell your doctor or pharmacist if you are taking, have recently taken or might take any other medicines.

Hyrimoz can be taken together with methotrexate or certain disease-modifying anti-rheumatic agents (sulfasalazine, hydroxychloroquine, leflunomide and injectable gold preparations), corticosteroids or pain medications including non-steroidal anti-inflammatory drugs (NSAIDs).

You should not take Hyrimoz with medicines containing the active substances anakinra or abatacept due to increased risk of serious infection. The combination of adalimumab as well as other TNF-

antagonists and anakinra or abatacept is not recommended based upon the possible increased risk for infections, including serious infections and other potential pharmacological interactions. If you have questions, please ask your doctor.

Pregnancy and breast-feeding

- You should consider the use of adequate contraception to prevent pregnancy and continue its use for at least 5 months after the last Hyrimoz treatment.
- If you are pregnant, think you may be pregnant or are planning to have a baby, ask your doctor for advice before taking this medicine.
- Hyrimoz should only be used during a pregnancy if needed.
- According to a pregnancy study, there was no higher risk of birth defects when the mother had received adalimumab during pregnancy compared with mothers with the same disease who did not receive adalimumab.
- Hyrimoz can be used during breast-feeding.
- If you receive Hyrimoz during your pregnancy, your baby may have a higher risk for getting an infection.
- It is important that you tell your baby's doctors and other health care professionals about your Hyrimoz use during your pregnancy before the baby receives any vaccine (for more information on vaccines see the "Warnings and precautions" section).

Driving and using machines

Hyrimoz may have a minor influence on your ability to drive, cycle or use machines. Room spinning sensation (vertigo) and vision disturbances may occur after taking Hyrimoz.

Hyrimoz contains sodium

This medicine contains less than 1 mmol of sodium (23 mg) per 0.8 ml dose, that is to say essentially 'sodium-free'.

3. How to use Hyrimoz

Always use this medicine exactly as your doctor or pharmacist has told you. Check with your doctor or pharmacist if you are not sure.

The recommended doses for Hyrimoz in each of the approved uses are shown in the following table. Your doctor may prescribe another strength of Hyrimoz if you need a different dose.

Rheumatoid arthritis, psoriatic arthritis, ankylosing spondylitis or axial spondyloarthritis without radiographic evidence of ankylosing spondylitis		
Age or body weight	How much and how often to take?	Notes
Adults	40 mg every other week as a single dose.	In rheumatoid arthritis, methotrexate is continued while using Hyrimoz. If your doctor determines that methotrexate is inappropriate, Hyrimoz can be given alone. If you have rheumatoid arthritis and you do not receive methotrexate with your Hyrimoz therapy, your doctor may decide to give 40 mg Hyrimoz every week or 80 mg every other week.

Plaque Psoriasis		
Age or body weight	How much and how often to take?	Notes
Adults	First dose of 80 mg (one 80 mg injection), followed by 40 mg given every other week starting one week after the first dose.	You should continue to inject Hyrimoz for as long as your doctor has told you. If this dose does not work well enough, your doctor may increase the dose to 40 mg every week or 80 mg every other week.

Hidradenitis suppurativa		
Age or body weight	How much and how often to take?	Notes
Adults	First dose of 160 mg (two 80 mg injections in one day or one 80 mg injection per day for two consecutive days), followed by an 80 mg dose (one 80 mg injection) two weeks later. After two further weeks, continue with a dose of 40 mg every week or 80 mg every other week, as prescribed by your doctor.	It is recommended that you use an antiseptic wash daily on the affected areas.
Adolescents from 12 to 17 years of age weighing 30 kg or more	First dose of 80 mg (one 80 mg injection), followed by 40 mg every other week starting one week later.	If this dose does not work well enough, your doctor may increase the dose to 40 mg every week or 80 mg every other week. It is recommended that you use an antiseptic wash daily on the affected areas.

Crohn's disease		
Age or body weight	How much and how often to take?	Notes
Children, adolescents and adults weighing 40 kg or more	<p>First dose of 80 mg (one 80 mg injections), followed by 40 mg every other week starting two weeks later.</p> <p>If a faster response is required your doctor may prescribe a first dose of 160 mg (two 80 mg injections in one day or one 80 mg injections per day for two consecutive days), followed by 80 mg (one 80 mg injection in one day) two weeks later.</p> <p>Thereafter the usual dose is 40 mg every other week.</p>	If this dose does not work well enough, your doctor may increase the dose to 40 mg every week or 80 mg every other week.

Paediatric Crohn's disease		
Age or body weight	How much and how often to take?	Notes
Children and adolescents from 6 to 17 years of age weighing less than 40 kg	<p>First dose of 40 mg, followed by 20 mg every other week starting two weeks later.</p> <p>If a faster response is required, your doctor may prescribe a first dose of 80 mg (one 80 mg injections in one day), followed by 40 mg two weeks later.</p> <p>Thereafter the usual dose is 20 mg every other week.</p>	If this dose does not work well enough, your child's doctor may increase the dose frequency to 20 mg every week.

Ulcerative colitis		
Age or body weight	How much and how often to take?	Notes
Adults	<p>First dose is 160 mg (two 80 mg injections in one day or one 80 mg injection per day for two consecutive days), followed by 80 mg (one 80 mg injection) two weeks later.</p> <p>Thereafter, the usual dose is 40 mg every other week.</p>	If this dose does not work well enough, your doctor may increase the dose to 40 mg every week or 80 mg every other week.

Paediatric ulcerative colitis		
Age and body weight	How much and how often to take?	Notes
Children and adolescents from	First dose is 160 mg (two 80 mg injections in one day or	Patients who turn 18 years of age while on 80 mg every

6 years of age weighing 40 kg or more	one 80 mg injection per day for two consecutive days) initially, followed by 80 mg (one 80 mg injection in one day) two weeks later. Thereafter the usual dose is 80 mg every other week.	other week, should continue their prescribed dose.
Children and adolescents from 6 years of age weighing less than 40 kg	First dose is 80 mg (one 80 mg injection) initially followed by 40 mg (as one 40 mg injection) two weeks later. Thereafter, the usual dose is 40 mg every other week.	Patients who turn 18 years of age while on 40 mg every other week, should continue their prescribed dose.
Non-infectious uveitis		
Age or body weight	How much and how often to take?	Notes
Adults	First dose of 80 mg (one 80 mg injection), followed by 40 mg every other week starting one week after the first dose.	In non-infectious uveitis, corticosteroids or other medicines that influence the immune system may be continued while using Hyrimoz. Hyrimoz can also be given alone. You should continue to inject Hyrimoz for as long as your doctor has told you.
Children and adolescents from 2 years of age weighing 30 kg or more	40 mg every other week.	Your doctor may also prescribe a first dose of 80 mg which may be administered one week prior to the start of the usual dose of 40mg every other week. Hyrimoz is recommended for the use in combination with methotrexate.
Children and adolescents from 2 years of age weighing less than 30 kg	20 mg every other week.	Your doctor may also prescribe a first dose of 40 mg which may be administered one week prior to the start of the usual dose of 20 mg every other week. Hyrimoz is recommended for the use in combination with methotrexate.

Method and route of administration

Hyrimoz is administered by injection under the skin (by subcutaneous injection).

Detailed instructions on how to inject Hyrimoz are provided in section 7, “Instructions for use”.

If you use more Hyrimoz than you should

If you accidentally inject Hyrimoz more frequently than you should, call your doctor or pharmacist and explain that you have taken more than required. Always take the outer carton of medicine with you, even if it is empty.

If you forget to use Hyrimoz

If you forget to give yourself an injection, you should inject the next dose of Hyrimoz as soon as you remember. Then take your next dose as you would have on your originally scheduled day, had you not forgotten a dose.

If you stop using Hyrimoz

The decision to stop using Hyrimoz should be discussed with your doctor. Your symptoms may return upon stopping treatment.

If you have any further questions on the use of this medicine, ask your doctor or pharmacist.

4. Possible side effects

Like all medicines, this medicine can cause side effects, although not everybody gets them. Most side effects are mild to moderate. However, some may be serious and require treatment. Side effects may occur up to 4 months or more after the last Hyrimoz injection.

Seek medical attention urgently, if you notice any of the following signs of allergic reaction or heart failure:

- severe rash, hives;
- swollen face, hands, feet;
- trouble breathing, swallowing;
- shortness of breath with physical activity or upon lying down or swelling of the feet.

Tell your doctor as soon as possible, if you notice any of the following:

- signs and symptoms of infection such as fever, feeling sick, wounds, dental problems, burning on urination, feeling weak or tired or coughing;
- symptoms of nerve problems such as tingling, numbness, double vision or arm or leg weakness;
- signs of skin cancer such as a bump or open sore that doesn't heal;
- signs and symptoms suggestive of blood disorders such as persistent fever, bruising, bleeding, paleness.

The following side effects have been observed with adalimumab:

Very common (may affect more than 1 in 10 people)

- injection site reactions (including pain, swelling, redness or itching);
- respiratory tract infections (including cold, runny nose, sinus infection, pneumonia);
- headache;
- abdominal (belly) pain;
- nausea and vomiting;
- rash;
- pain in the muscles.

Common (may affect up to 1 in 10 people)

- serious infections (including blood poisoning and influenza);

- intestinal infections (including gastroenteritis);
- skin infections (including cellulitis and shingles);
- ear infections;
- mouth infections (including tooth infections and cold sores);
- reproductive tract infections;
- urinary tract infection;
- fungal infections;
- joint infections;
- benign tumours;
- skin cancer;
- allergic reactions (including seasonal allergy);
- dehydration;
- mood swings (including depression);
- anxiety;
- difficulty sleeping;
- sensation disorders such as tingling, prickling or numbness;
- migraine;
- symptoms of nerve root compression (including low back pain and leg pain);
- vision disturbances;
- eye inflammation;
- inflammation of the eye lid and eye swelling;
- vertigo (sensation of room spinning);
- sensation of heart beating rapidly;
- high blood pressure;
- flushing;
- haematoma (a solid swelling with clotted blood);
- cough;
- asthma;
- shortness of breath;
- gastrointestinal bleeding;
- dyspepsia (indigestion, bloating, heart burn);
- acid reflux disease;
- sicca syndrome (including dry eyes and dry mouth);
- itching;
- itchy rash;
- bruising;
- inflammation of the skin (such as eczema);
- breaking of finger nails and toe nails;
- increased sweating;
- hair loss;
- new onset or worsening of psoriasis;
- muscle spasms;
- blood in urine;
- kidney problems;
- chest pain;
- oedema (a build-up of fluid in the body which causes the affected tissue to swell);
- fever;
- reduction in blood platelets which increases risk of bleeding or bruising;
- impaired healing.

Uncommon (may affect up to 1 in 100 people)

- unusual infections (which include tuberculosis and other infections) that occur when resistance to disease is lowered;

- neurological infections (including viral meningitis);
- eye infections;
- bacterial infections;
- diverticulitis (inflammation and infection of the large intestine);
- cancer, including cancer that affects the lymph system (lymphoma) and melanoma (a type of skin cancer);
- immune disorders that could affect the lungs, skin and lymph nodes (most commonly as a condition called sarcoidosis);
- vasculitis (inflammation of blood vessels);
- tremor (shaking);
- neuropathy (nerve damage);
- stroke;
- hearing loss, buzzing;
- sensation of heart beating irregularly such as skipped beats;
- heart problems that can cause shortness of breath or ankle swelling;
- heart attack;
- a sac in the wall of a major artery, inflammation and clot of a vein; blockage of a blood vessel;
- lung diseases causing shortness of breath (including inflammation);
- pulmonary embolism (blockage in an artery of the lung);
- pleural effusion (abnormal collection of fluid in the pleural space);
- inflammation of the pancreas which causes severe pain in the abdomen and back;
- difficulty in swallowing;
- facial oedema (swelling);
- gallbladder inflammation, gallbladder stones;
- fatty liver (build-up of fat in liver cells);
- night sweats;
- scar;
- abnormal muscle breakdown;
- systemic lupus erythematosus (an immune disorder including inflammation of skin, heart, lung, joints and other organ systems);
- sleep interruptions;
- impotence;
- inflammations.

Rare (may affect up to 1 in 1 000 people)

- leukaemia (cancer affecting the blood and bone marrow);
- severe allergic reaction with shock;
- multiple sclerosis;
- nerve disorders (such as inflammation of the optic nerve to the eye, and Guillain-Barré syndrome, a condition that may cause muscle weakness, abnormal sensations, tingling in the arms and upper body);
- heart stops pumping;
- pulmonary fibrosis (scarring of the lung);
- intestinal perforation (hole in the wall of the gut);
- hepatitis (liver inflammation);
- reactivation of hepatitis B infection;
- autoimmune hepatitis (inflammation of the liver caused by the body's own immune system);
- cutaneous vasculitis (inflammation of blood vessels in the skin);
- Stevens-Johnson syndrome (life-threatening reaction with flu-like symptoms and blistering rash);
- facial oedema (swelling) associated with allergic reactions;
- erythema multiforme (inflammatory skin rash);
- lupus-like syndrome;

- angioedema (localised swelling of the skin);
- lichenoid skin reaction (itchy reddish-purple skin rash).

Not known (frequency cannot be estimated from available data)

- hepatosplenic T-cell lymphoma (a rare blood cancer that is often fatal);
- Merkel cell carcinoma (a type of skin cancer);
- Kaposi's sarcoma, a rare cancer related to infection with human herpes virus 8. Kaposi's sarcoma most commonly appears as purple lesions on the skin;
- liver failure;
- worsening of a condition called dermatomyositis (seen as a skin rash accompanying muscle weakness);
- weight gain (for most patients, the weight gain was small)

Some side effects observed with adalimumab may not have symptoms and may only be discovered through blood tests. These include:

Very common (may affect more than 1 in 10 people)

- low blood measurements for white blood cells;
- low blood measurements for red blood cells;
- increased lipids in the blood;
- raised liver enzymes.

Common (may affect up to 1 in 10 people)

- high blood measurements for white blood cells;
- low blood measurements for platelets;
- increased uric acid in the blood;
- abnormal blood measurements for sodium;
- low blood measurements for calcium;
- low blood measurements for phosphate;
- high blood sugar;
- high blood measurements for lactate dehydrogenase;
- autoantibodies present in the blood;
- low blood potassium.

Uncommon (may affect up to 1 in 100 people)

- raised bilirubin measurement (liver blood test).

Rare (may affect up to 1 in 1 000 people)

- low blood measurements for white blood cells, red blood cells and platelet count.

Reporting of side effects

If you get any side effects, talk to your doctor or pharmacist. This includes any possible side effects not listed in this leaflet. You can also report side effects directly via [the national reporting system listed in Appendix V](#). By reporting side effects, you can help provide more information on the safety of this medicine.

5. How to store Hyrimoz

Keep this medicine out of the sight and reach of children.

Do not use this medicine after the expiry date which is stated on the label/blister/carton after EXP. The expiry date refers to the last day of that month.

Store in a refrigerator (2°C–8°C). Do not freeze.

Keep the pre-filled pen in the outer carton in order to protect from light.

Alternative Storage:

When needed (for example when you are travelling), Hyrimoz may be stored at room temperature (up to 25°C) for a maximum period of 42 days – be sure to protect it from light. Once removed from the refrigerator for room temperature storage, your pre-filled pen **must be used within 42 days or discarded**, even if it is later returned to the refrigerator. You should record the date when your pre-filled pen is first removed from the refrigerator, and the date after which it should be discarded.

Do not throw away any medicines via wastewater or household waste. Ask your pharmacist how to throw away medicines you no longer use. These measures will help protect the environment.

6. Contents of the pack and other information

What Hyrimoz contains

- The active substance is adalimumab. Each pre-filled pen contains 80 mg of adalimumab in 0.8 ml of solution.

The other ingredients are adipic acid, mannitol (E 421) , polysorbate 80 (E 433), hydrochloric acid (E 507), sodium hydroxide (E 524) and water for injections (see section 2 “Hyrimoz contains sodium”).

What Hyrimoz looks like and contents of the pack

Hyrimoz 80 mg solution for injection (injection) in pre-filled pen is supplied as a 0.8 ml clear to slightly opalescent, colourless or slightly yellowish solution.

Hyrimoz is supplied in a single-use pre-filled syringe assembled into a triangular-shaped pen with transparent window and label. The syringe inside the pen is made of type I glass with a stainless steel 29 gauge needle and an inner rubber needle cap (thermoplastic elastomer), containing 0.8 ml of solution.

Cartons contain 1, 2 and 3 pre-filled pens of Hyrimoz.

Not all pack sizes may be marketed.

Hyrimoz is available as a pre-filled syringe and a pre-filled pen .

Marketing Authorisation Holder

Sandoz GmbH
Biochemiestr. 10
6250 Kundl
Austria

Manufacturer

Sandoz GmbH Schafteuau
Biochemiestr. 10
6336 Langkampfen
Austria

Novartis Pharmaceutical Manufacturing GmbH
Biochemiestrasse 10
6336 Langkampfen
Austria

For any information about this medicine, please contact the local representative of the Marketing Authorisation Holder:

België/Belgique/Belgien

Sandoz nv/sa
Tél/Tel: +32 2 722 97 97

Lietuva

Sandoz Pharmaceuticals d.d filialas
Tel: +370 5 2636 037

България

Сандоз България КЧТ
Тел.: +359 2 970 47 47

Luxembourg/Luxemburg

Sandoz nv/sa (Belgique/Belgien)
Tél/Tel.: +32 2 722 97 97

Česká republika

Sandoz s.r.o.
Tel: +420 225 775 111

Magyarország

Sandoz Hungária Kft.
Tel.: +36 1 430 2890

Danmark/Norge/Ísland/Sverige

Sandoz A/S
Tlf./Sími/Tel: +45 63 95 10 00

Malta

Sandoz Pharmaceuticals d.d.
Tel: +356 99644126

Deutschland

Hexal AG
Tel: +49 8024 908 0

Nederland

Sandoz B.V.
Tel: +31 36 52 41 600

Eesti

Sandoz d.d. Eesti filiaal
Tel: +372 665 2400

Österreich

Sandoz GmbH
Tel: +43 5338 2000

Ελλάδα

SANDOZ HELLAS ΜΟΝΟΠΡΟΣΩΠΗ Α.Ε.
Τηλ: +30 216 600 5000

Polska

Sandoz Polska Sp. z o.o.
Tel.: +48 22 209 70 00

España

Sandoz Farmacéutica, S.A.
Tel: +34 900 456 856

Portugal

Sandoz Farmacêutica Lda.
Tel: +351 21 000 86 00

France

Sandoz SAS
Tél: +33 1 49 64 48 00

România

Sandoz Pharmaceuticals SRL
Tel: +40 21 407 51 60

Hrvatska

Sandoz d.o.o.
Tel: +385 1 23 53 111

Ireland

Rowex Ltd.
Tel: + 353 27 50077

Italia

Sandoz S.p.A.
Tel: +39 02 96541

Κόπος

SANDOZ HELLAS MONOΠΡΟΣΩΠΗ Α.Ε.
(Ελλάδα)
Τηλ: +30 216 600 5000

Latvija

Sandoz d.d. Latvia filiāle
Tel: +371 67 892 006

Slovenija

Sandoz farmacevtska družba d.d.
Tel: +386 1 580 29 02

Slovenská republika

Sandoz d.d. - organizačná zložka
Tel: +421 2 48 200 600

Suomi/Finland

Sandoz A/S
Puh/Tel: +358 10 6133 400

United Kingdom (Northern Ireland)

Sandoz GmbH
Tel: +43 5338 2000

This leaflet was last revised in

Other sources of information

Detailed information on this medicine is available on the European Medicines Agency web site:
<https://www.ema.europa.eu>.

7. Instructions for use

To help avoid possible infections and to ensure that you use the Hyrimoz correctly, it is important that you follow these instructions.

Be sure that you read, understand, and follow these Instructions for use before injecting Hyrimoz. Your healthcare provider should show you how to prepare and inject Hyrimoz properly using the Hyrimoz single-dose pre-filled pen before you use it for the first time. Talk to your healthcare provider if you have any questions.

Your Hyrimoz single-use pre-filled pen

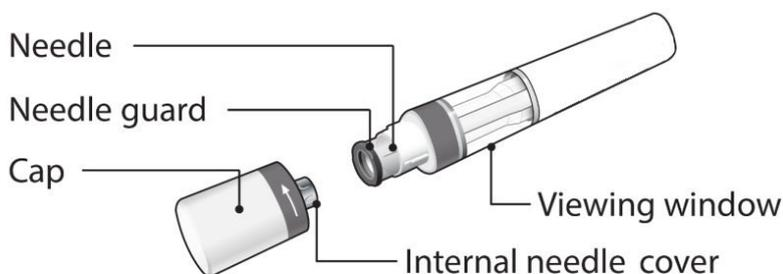

Figure A: Hyrimoz pen parts

In *Figure A*, the pen is shown with the cap removed. **Do not remove** the cap until you are ready to inject.

It is important that you:

- **do not use** the pen if either the seal on the outer carton or the safety seal on the pen is broken.
- Keep your pen in the sealed outer carton until you are ready to use it.
- **never leave** the pen unattended where others might tamper with it.
- **do not use** your pen, if you dropped it, it looks damaged, or if you dropped it with the cap removed.
- **inject** Hyrimoz 15–30 minutes after taking it out of the refrigerator for a more comfortable injection.
- throw away the used pen right away after use. **Do not re-use the pen.** See “8. Disposing of used pens” at the end of this Instructions for Use.

How should you store your pen?

- Store your pen carton in a refrigerator, between 2°C to 8°C.
- When needed, for example when you are travelling, Hyrimoz may be stored at room temperature (up to 25°C) for a maximum period of 42 days. – be sure to protect it from light. Once removed from the refrigerator for room temperature storage, your pre-filled pen **must be used within 42 days or discarded**, even if it is later returned to the refrigerator.
- You should record the date when your pre-filled pen is first removed from the refrigerator, and the date after which it should be discarded.
- Keep your pen in the original carton until ready to use to protect from light.
- Do not store your pen in extreme heat or cold.
- Do not freeze your pen.

Keep Hyrimoz and all medicines out of the reach of children.

What do you need for your injection?

Place the following items on a clean, flat surface.

Included in your carton are:

- Hyrimoz pre-filled pen/s (see **Figure A**). Each pen contains 80 mg/0.8 ml of adalimumab.

Not included in your pen carton are (see **Figure B**):

- Alcohol wipe
- Cotton ball or gauze
- Sharps disposal container See “8. Disposing of used pens” at the end of these Instructions for Use
- Adhesive bandage.

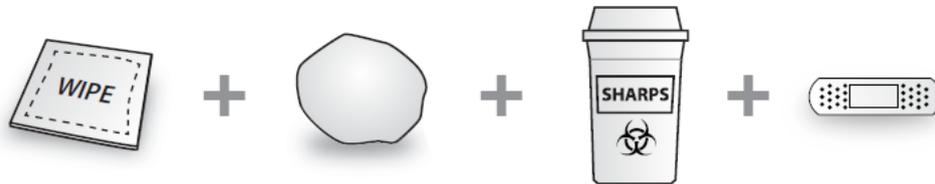

Figure B: items not included in the carton

Before your injection

Preparing the pen

- For a more comfortable injection, take your pen out of the refrigerator 15 to 30 minutes before injecting Hyrimoz to allow it to reach room temperature.
- Look through the viewing window. The solution should be colourless or slightly yellowish as well as clear to slightly opalescent. **Do not use** if any particulates and/or discolorations are observed. You may see small air bubbles, which is normal. If you are concerned with the appearance of the solution, then contact your pharmacist for assistance
- Look at the expiry date (EXP) on your pen (see **Figure C**). Do not use your pen if the expiry date has passed.
- Do not use if the safety seal has been broken.

Contact your pharmacist if the pen fails any of the above mentioned checks.

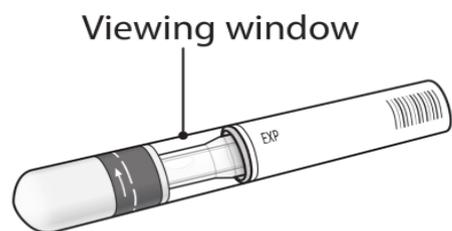
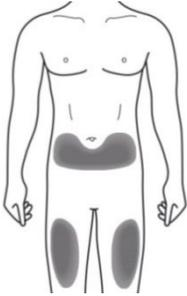
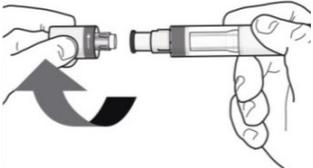
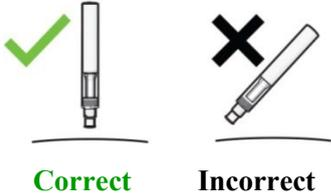

Figure C: safety checks before injection

<p>1. Choosing your injection site:</p> <ul style="list-style-type: none"> • The recommended injection site is the front of your thighs. You may also use the lower abdomen, but not the area 5 cm around your navel (belly button) (see <i>Figure D</i>). • Choose a different site each time you give yourself an injection. • Do not inject into areas where the skin is tender, bruised, red, scaly, or hard. Avoid areas with scars or stretch marks. If you have psoriasis, you should NOT inject directly into areas with psoriasis plaques. 	 <p><i>Figure D:</i> choose your injection site</p>
--	--

<p>2. Cleaning your injection site:</p> <ul style="list-style-type: none"> • Wash your hands well with soap and water. • Using a circular motion, clean the injection site with an alcohol wipe. Let it dry before injecting (see <i>Figure E</i>). • Do not touch the cleaned area again before injecting. 	 <p><i>Figure E:</i> clean your injection site</p>
---	--

<p>3. Removing the cap of your pen:</p> <ul style="list-style-type: none"> • Only remove the cap when you are ready to use the pen. • Twist off the cap in the direction of the arrows (see <i>Figure F</i>). • Once removed, throw away the cap. Do not try to re-attach the cap. • Use your pen within 5 minutes of removing the cap. • You may see a few drops of liquid come out of the needle. This is normal. 	 <p><i>Figure F:</i> remove the cap</p>
--	---

<p>4. Holding the pen:</p>	
<ul style="list-style-type: none"> • Hold your pen at 90 degrees to the cleaned injection site (see <i>Figure G</i>). 	 <p><i>Figure G:</i> hold your pen</p>

Your injection

You must read this before injecting

During the injection you will hear **2 loud clicks**:

- The **first click** indicates that the injection has **started**.
- Several seconds later a **second click** will indicate that the injection is **almost finished**.

You must keep holding your pen firmly against your skin until you see a **green indicator** fill the window and stop moving.

5. Starting your injection:

- Press your pen firmly against the skin to start the injection (see *Figure H*).
- The **first click** indicates the injection has started.
- **Keep holding** your pen firmly against your skin.
- The **green indicator** shows the progress of the injection.

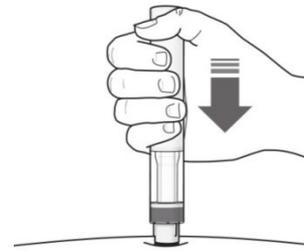

Figure H: start your injection

6. Completing your injection:

- Listen for the **second click**. This indicates the injection is **almost complete**.
- Check the **green indicator** fills the window and has stopped moving (see *Figure I*).
- The pen can now be removed.



Figure I: complete your injection

After your injection

7. Check the green indicator fills the window (see *Figure J*):

- This means the medicine has been delivered. Contact your doctor if the green indicator is not visible.
- There may be a small amount of blood at the injection site. You can press a cotton ball or gauze over the injection site and hold it for 10 seconds. Do not rub the injection site. You may cover the injection site with a small adhesive bandage, if needed.



Figure J: check the green indicator

8. Disposing of used pens:

- Dispose of the used pens in a sharps container (closable, puncture-resistant container, see *Figure K*). For the safety and health of you and others, the pens must never be re-used.
- Do not throw away any medicines via wastewater or household waste. Ask your doctor or pharmacist how to throw away medicines you no longer use. These measures will help protect the environment. Any unused product or waste material should be disposed of in accordance with local requirements.

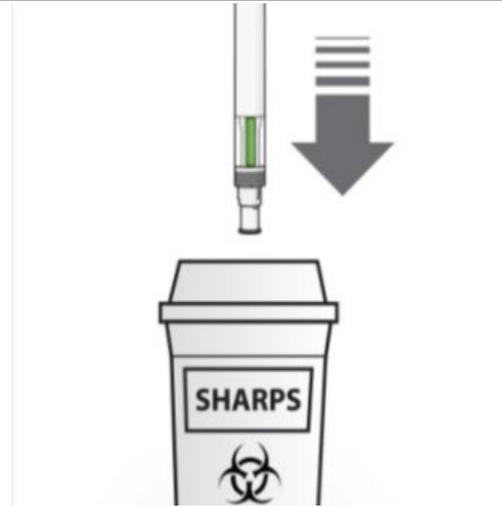

Figure K: dispose of your used pen

If you have any questions, please talk to a doctor, pharmacist or nurse who is familiar with Hyrimoz.