

ANNEX I
SUMMARY OF PRODUCT CHARACTERISTICS

1. NAME OF THE MEDICINAL PRODUCT

CAMCEVI 42 mg prolonged-release suspension for injection

2. QUALITATIVE AND QUANTITATIVE COMPOSITION

Each pre-filled syringe with prolonged-release suspension for injection contains leuporelin mesilate equivalent to 42 mg leuporelin.

For the full list of excipients, see section 6.1.

3. PHARMACEUTICAL FORM

Prolonged-release suspension for injection.

Pre-filled syringe with off-white to pale yellow viscous and opalescent suspension.

4. CLINICAL PARTICULARS

4.1 Therapeutic indications

CAMCEVI is indicated for the treatment of hormone dependent advanced prostate cancer and for the treatment of high-risk localised and locally advanced hormone dependent prostate cancer in combination with radiotherapy.

4.2 Posology and method of administration

Posology

Adult prostate cancer patients

CAMCEVI should be administered under the direction of a healthcare professional having available the appropriate expertise for monitoring the response to treatment.

CAMCEVI 42 mg is administered as a single subcutaneous injection every six months. The injected suspension forms a solid medicinal product delivery depot and provides continuous release of leuporelin over a six-month period.

As a rule, therapy of advanced prostate cancer with leuporelin entails long-term treatment and therapy should not be discontinued when remission or improvement occurs.

Leuporelin may be used as neoadjuvant or adjuvant therapy in combination with radiotherapy in high-risk localised and locally advanced prostate cancer.

Response to leuporelin should be monitored by clinical parameters and by measuring prostate specific antigen (PSA) serum levels. Clinical studies have shown that testosterone levels increased during the first 3 days of treatment in the majority of non-orchietomised patients and then decreased to below medical castration levels within 3 to 4 weeks. Once attained, castrate levels were maintained as long as leuporelin therapy continued (<1% testosterone breakthroughs). In case the patient's response appears to be sub-optimal, it should be confirmed that serum testosterone levels have reached or are remaining at castrate levels.

In patients with metastatic castration resistant prostate cancer not surgically castrated receiving a gonadotropin-releasing hormone (GnRH) agonist, such as leuporelin, and eligible for

treatment with androgen biosynthesis inhibitors or androgen receptor inhibitors, treatment with a GnRH agonist may be continued.

Special populations

Renal/hepatic impairment

No clinical studies were performed in patients having either renal or hepatic impairment.

Paediatric population

The safety and efficacy of leuprorelin in children aged 0 to 18 years have not been established (see also section 4.3). No data are available.

Method of administration

CAMCEVI should be administered subcutaneously only by healthcare professionals who are familiar with these procedures. For instructions on administration of the medicinal product, see section 6.6.

Intra-arterial or intravenous injection, respectively, has to be strictly avoided.

As with other medicinal products administered by subcutaneous injection, the injection site should be varied periodically.

4.3 Contraindications

CAMCEVI is contraindicated in women and paediatric patients.

Hypersensitivity to the active substance, to other GnRH agonists or to any of the excipients listed in section 6.1.

Patients who previously underwent orchiectomy (as with other GnRH agonists, leuprorelin does not result in further decrease of serum testosterone in case of surgical castration).

As sole treatment in prostate cancer patients with spinal cord compression or evidence of spinal metastases (see also section 4.4).

4.4 Special warnings and precautions for use

Androgen deprivation therapy may prolong the QT interval

In patients with a history of or risk factors for QT prolongation and in patients receiving concomitant medicinal products that might prolong the QT interval (see section 4.5) physicians should assess the benefit/risk ratio including the potential for Torsade de pointes prior to initiating leuprorelin. Periodic monitoring of electrocardiograms and electrolytes should be considered.

Cardiovascular diseases

Increased risk of developing myocardial infarction, sudden cardiac death and stroke has been reported in association with use of GnRH agonists in men. The risk appears low based on the reported odds ratios, and should be evaluated carefully along with cardiovascular risk factors when determining a treatment for patients with prostate cancer. Patients receiving GnRH agonists should be monitored for symptoms and signs suggestive of development of cardiovascular disease and be managed according to current clinical practice.

Transient testosterone flare

Leuporelin, like other GnRH agonists, causes a transient increase in serum concentrations of testosterone, dihydrotestosterone and acid phosphatase during the first week of treatment. Patients may experience worsening of symptoms or onset of new symptoms, including bone pain, neuropathy, haematuria, or ureteral or bladder outlet obstruction (see section 4.8). These symptoms usually subside on continuation of therapy.

Additional administration of an appropriate antiandrogen should be considered beginning 3 days prior to leuporelin therapy and continuing for the first two to three weeks of treatment. This has been reported to prevent the sequelae of an initial rise in serum testosterone.

Following surgical castration, leuporelin does not lead to a further decrease in serum testosterone levels in male patients.

Bone density

Decreased bone density has been reported in the medical literature in men who have had orchiectomy or who have been treated with GnRH agonists (see section 4.8).

Antiandrogen therapy significantly increases the risk for fractures owing to osteoporosis. Only limited data is available on this issue. Fractures owing to osteoporosis were observed in 5% of patients following 22 months of pharmacological androgen deprivation therapy and in 4% of patients following 5 to 10 years of treatment. The risk for fractures owing to osteoporosis is generally higher than the risk for pathological fractures.

Apart from long lasting testosterone deficiency, increased age, smoking and consumption of alcoholic beverages, obesity and insufficient exercise may have an influence on the development of osteoporosis.

Pituitary apoplexy

During post-marketing surveillance, rare cases of pituitary apoplexy (a clinical syndrome secondary to infarction of the pituitary gland) have been reported after the administration of GnRH agonists, with a majority occurring within 2 weeks of the first dose, and some within the first hour. In these cases, pituitary apoplexy was presented as sudden headache, vomiting, visual changes, ophthalmoplegia, altered mental status, and sometimes cardiovascular collapse. Immediate medical attention is required.

Hyperglycemia and diabetes

Hyperglycemia and an increased risk of developing diabetes have been reported in men receiving GnRH agonists. Hyperglycemia may represent development of diabetes mellitus or worsening of glycemic control in patients with diabetes. Blood glucose and/or glycosylated haemoglobin (HbA1c) should be monitored periodically in patients receiving a GnRH agonist and patients should be managed with current practice for treatment of hyperglycemia or diabetes.

Convulsions

Post-marketing reports of convulsions have been observed in patients on leuporelin with or without a history of predisposing factors (see section 4.8). Convulsions are to be managed according to the current clinical practice.

Idiopathic intracranial hypertension:

Idiopathic intracranial hypertension (pseudotumor cerebri) has been reported in patients receiving leuporelin. Patients should be warned for signs and symptoms of idiopathic

intracranial hypertension, including severe or recurrent headache, vision disturbances and tinnitus. If idiopathic intracranial hypertension occurs, discontinuation of leuprorelin should be considered.

Other events

Cases of ureteral obstruction and spinal cord compression, which may contribute to paralysis with or without fatal complications, have been reported with GnRH agonists. If spinal cord compression or renal impairment develops, standard treatment of these complications should be instituted.

Patients with vertebral and/or brain metastases as well as patients with urinary tract obstruction should be closely monitored during the first few weeks of therapy.

4.5 Interaction with other medicinal products and other forms of interaction

No pharmacokinetic drug-drug interaction studies have been performed. There have been no reports of any interactions of leuprorelin with other medicinal products.

Since androgen deprivation treatment may prolong the QT interval, the concomitant use of leuprorelin with medicinal products known to prolong the QT interval or medicinal products able to induce Torsade de pointes such as class IA (e.g. quinidine, disopyramide) or class III (e.g. amiodarone, sotalol, dofetilide, ibutilide) antiarrhythmic medicinal products, methadone, moxifloxacin, antipsychotics, etc. should be carefully evaluated (see section 4.4).

4.6 Fertility, pregnancy and lactation

CAMCEVI is contraindicated in women.

Based on findings in animals and mechanism of action, leuprorelin may impair fertility in males of reproductive potential (see section 5.3).

4.7 Effects on ability to drive and use machines

Leuprorelin-containing medicinal products have minor influence on the ability to drive and use machines. The administration of this medicinal product can cause fatigue, dizziness and visual disturbances (see sections 4.8). Patients should be advised not to drive or operate machinery if these adverse reactions occur.

4.8 Undesirable effects

Summary of the safety profile

Adverse reactions seen with leuprorelin-containing medicinal products are mainly subject to the specific pharmacological action of leuprorelin, namely increases and decreases in certain hormone levels. The most commonly reported adverse reactions are hot flashes, nausea, malaise and fatigue and transient local irritation at the site of injection. Mild or moderate hot flashes occur in approximately 58% of patients.

Tabulated list of adverse reactions

The following undesirable effects were reported during clinical studies with leuprorelin-containing medicinal products for injection in patients with advanced prostate carcinoma. Undesirable effects are classified, by frequency, as very common ($\geq 1/10$), common ($\geq 1/100$, $< 1/10$), uncommon ($\geq 1/1,000$, $< 1/100$), rare ($\geq 1/10,000$, $< 1/1,000$) and very rare ($< 1/10,000$), not known (cannot be estimated from the available data).

Table 1: Undesirable effects reported for leuprorelin-containing medicinal products for injection

Infections and infestations	
common	nasopharyngitis
uncommon	urinary tract infection, local skin infection
Blood and lymphatic system disorders	
common	haematology changes, anaemia
Metabolism and nutrition disorders	
uncommon	aggravated diabetes mellitus
Psychiatric disorders	
uncommon	abnormal dreams, depression, decreased libido
Nervous system disorders	
uncommon	dizziness, headache, hypoaesthesia, insomnia, taste disturbance, smell disturbance, vertigo
rare	abnormal involuntary movements
not known	idiopathic intracranial hypertension (pseudotumor cerebri) (see section 4.4)
Cardiac disorders	
uncommon	QT prolongation (see sections 4.4 and 4.5), myocardial infarction (see section 4.4)
Vascular disorders	
very common	hot flashes
uncommon	hypertension, hypotension
rare	syncope, collapse
Respiratory, thoracic and mediastinal disorders	
uncommon	rhinorrhoea, dyspnoea
not known	interstitial lung disease
Gastrointestinal disorders	
common	nausea, diarrhoea, gastroenteritis/colitis
uncommon	constipation, dry mouth, dyspepsia, vomiting
rare	flatulence, eructation
Skin and subcutaneous tissue disorders	
very common	ecchymoses, erythema
common	pruritus, night sweats
uncommon	clamminess, increased sweating
rare	alopecia, skin eruption
Musculoskeletal and connective tissues disorders	
common	arthralgia, limb pain, myalgia, rigors, weakness
uncommon	back pain, muscle cramps
Renal and urinary disorders	
common	urinary infrequency, difficulty in micturation, dysuria, nocturia, oliguria
uncommon	bladder spasm, haematuria, aggravated urinary frequency, urinary retention
Reproductive system and breast disorders	
common	breast tenderness, testicular atrophy, testicular pain, infertility, breast hypertrophy, erectile dysfunction, reduced penis size
uncommon	gynaecomastia, impotence, testicular disorder

rare	breast pain
General disorders and administration site conditions	
very common	fatigue, injection site burning, injection site paraesthesia
common	malaise, injection site pain, injection site bruising, injection site stinging
uncommon	injection site pruritus, injection site induration, lethargy, pain, pyrexia
rare	injection site ulceration
very rare	injection site necrosis
Investigations	
common	increased blood creatinine phosphokinase, prolonged coagulation time
uncommon	increased alanine aminotransferase, increased blood triglycerides, prolonged prothrombin time, increased weight

Description of selected adverse reactions

Other undesirable effects which have been reported in general to occur with leuprorelin treatment include peripheral oedema, pulmonary embolism, palpitations, myalgia, an alteration in the skin sensation, muscle weakness, chills, rash, amnesia, and visual disturbances. Muscular atrophy has been observed with long-term use of medicinal products in this class. Infarction of pre-existing pituitary adenoma has been reported rarely after administration of both short and long acting GnRH agonists. There have been rare reports of thrombocytopenia and leucopenia. Changes in glucose tolerance have been reported.

Convulsions have been reported after GnRH agonist analogue administration (see section 4.4).

Local adverse reactions reported after injection of leuprorelin-containing medicinal products are similar to the local adverse reactions associated with similar subcutaneously injected medicinal products. Generally, these localised adverse reactions following subcutaneous injection are mild and described as being of brief duration.

Anaphylactic/anaphylactoid reactions have been reported rarely after GnRH agonist analogue administration.

Changes in bone density

Decreased bone density has been reported in the medical literature in men who have had orchiectomy or who have been treated with a GnRH analogue. It can be anticipated that long periods of treatment with leuprorelin may show increasing signs of osteoporosis. Regarding the increased risk for fractures owing to osteoporosis (see section 4.4).

Exacerbation of signs and symptoms of the disease

Treatment with leuprorelin can cause exacerbations of signs and symptoms of the disease during the first few weeks. If conditions such as vertebral metastases and/or urinary obstruction or haematuria are aggravated, neurological problems, such as weakness and/or paraesthesia of the lower limbs or worsening of urinary symptoms may occur.

Clinical experience on local skin tolerability with CAMCEVI

Local skin tolerability of CAMCEVI was assessed in the main study FP01C-13-001 per four aspects: itchiness, erythema, burning, and stinging sensation. Of the 137 subjects receiving subcutaneous injections of CAMCEVI, most subjects showed no to mild skin irritation after the injection. Generally, the reported localised events were mild to moderate and resolved.

Reporting of suspected adverse reactions

Reporting suspected adverse reactions after authorisation of the medicinal product is important. It allows continued monitoring of the benefit/risk balance of the medicinal product. Healthcare professionals are asked to report any suspected adverse reactions via the national reporting system listed in [Appendix V](#).

4.9 Overdose

Leuprorelin does not have the potential for abuse, and deliberate overdose is unlikely. There are no reports of abuse or overdose having occurred in clinical practice with leuprorelin, but in the event that excessive exposure becomes a reality, observation and symptomatic supportive treatment are recommended.

5. PHARMACOLOGICAL PROPERTIES

5.1 Pharmacodynamic properties

Pharmacotherapeutic group: Endocrine therapy, gonadotropin releasing hormone analogues;
ATC code: L02AE02

Mechanism of action

Leuprorelin mesilate is a synthetic nonapeptide agonist of naturally occurring GnRH that, when given continuously, inhibits pituitary gonadotropin secretion and suppresses testicular steroidogenesis in males. This effect is reversible upon discontinuation of medicinal product therapy. However, the agonist possesses greater potency than the natural hormone and the time to recovery of testosterone levels may vary between patients.

Pharmacodynamic effects

Administration of leuprorelin results in an initial increase in circulating levels of luteinising hormone (LH) and follicle stimulating hormone (FSH), leading to a transient increase in levels of the gonadal steroids, testosterone and dihydrotestosterone in males. Continuous administration of leuprorelin results in decreased levels of LH and FSH. In males, testosterone is reduced to below castrate threshold (≤ 50 ng/dL).

Following the first dose of leuprorelin, mean serum testosterone concentrations transiently increased, then fell to below castrate threshold levels (≤ 50 ng/dL) within 3-4 weeks, and were maintained below castrate threshold with 6-monthly administration of the medicinal product (Figure 1 below). Long-term studies on leuprorelin have shown that continuation of therapy maintains testosterone below the castrate level for up to seven years, and presumably indefinitely.

Tumour size was not measured directly during the clinical trial programme, but there was an indirect beneficial tumour response as shown by a 97% reduction in mean PSA for leuprorelin.

In a phase III randomised clinical study including 970 patients with locally advanced prostate cancer (mainly T2c-T4 with some T1c to T2b patients with pathological regional nodal disease) of whom 483 were assigned to short-term androgen suppression (6 months) in combination with radiation therapy and 487 to long-term therapy (3 years), a non-inferiority analysis compared the short-term to long-term concomitant and adjuvant hormonal treatment with GnRH agonist (triptorelin or goserelin). The 5-year overall mortality was 19.0% and 15.2%, in the short-term and long-term groups, respectively. The observed hazard ratio (HR) of 1.42 with an upper one-sided 95.71% CI of 1.79 or two-sided 95.71% CI of 1.09; 1.85 ($p=0.65$ for non-inferiority), demonstrate that the combination of radiotherapy plus 6 months of androgen deprivation

therapy provides inferior survival as compared with radiotherapy plus 3 years of androgen deprivation therapy. Overall survival at 5 years of long-term treatment and short-term treatment shows 84.8% and 81.0% survival, respectively. Overall quality of life using QLQ -C30 did not differ significantly between the two groups ($p=0.37$). Results are dominated by the population of patients with locally advanced tumours.

Evidence for the indication of high-risk localised prostate cancer is based on published studies of radiotherapy combined with GnRH analogues, including leuprorelin. Clinical data from five published studies were analysed (EORTC 22863, RTOG 85-31, RTOG 92-02, RTOG 8610, and D'Amico et al., JAMA, 2004), which all demonstrate a benefit for the combination of GnRH analogue with radiotherapy. Clear differentiation of the respective study populations for the indications locally advanced prostate cancer and high-risk localised prostate cancer was not possible in the published studies.

Clinical data have shown that radiotherapy followed by 3 years of androgen deprivation therapy is preferable to radiotherapy followed by 6 months of androgen deprivation therapy. The recommended duration of androgen deprivation therapy in medical guidelines for T3-T4 patients receiving radiotherapy is 2-3 years.

Clinical experience on efficacy with CAMCEVI

The multicentre, single-arm, open-label, 48-week phase 3 study of leuprorelin included 137 male patients with high-risk localised and locally advanced prostate cancer in need for androgen deprivation therapy. The efficacy of the medicinal product (two doses administered 24 weeks apart) was evaluated by the percentage of subjects with serum testosterone concentrations suppressed to castrate threshold levels, the effect on serum LH levels as measure for testosterone level control, and the effect on serum PSA levels.

The percentage of patients with serum testosterone levels below the castrate threshold (≤ 50 ng/dL) by day 28 was 98.5% (135 out of 137 patients; intent-to-treat) and 99.2% (123 out of 124 subjects; per protocol), respectively (Figure 1).

Figure 1: Mean serum testosterone concentration over time with CAMCEVI (n=124; per protocol population)

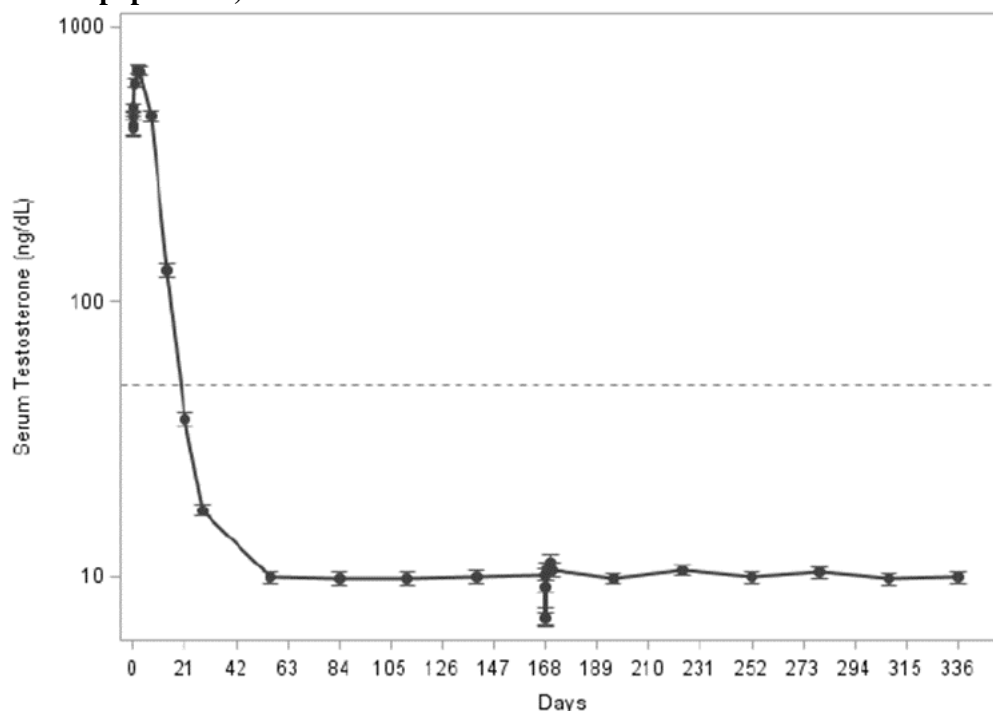

Dotted line indicates the castrate level (50 ng/dL) of serum testosterone.

Mean serum LH levels were significantly reduced after the first injection, and this effect remained until the end of the study (decrease versus baseline by 98% [day 336]). Tumour size was not directly measured in this study, but an indirect beneficial tumour response can be presumed for leuporelin as shown by a significant reduction in mean PSA levels over time after injection of the medicinal product (mean of 70 ng/mL at baseline decreased to a mean minimum of 2.6 ng/mL [per-protocol population] at Day 168).

Paediatric population

The European Medicines Agency has waived the obligation to submit the results of studies with the reference medicinal product containing leuporelin in all subsets of the paediatric population in prostate carcinoma (see section 4.2 for information on paediatric use).

5.2 Pharmacokinetic properties

Absorption

Following the first and the second doses of leuporelin, an initial rapid increase of serum leuporelin concentration was observed, followed by a rapid decline over the first 3 days post-dose: after an initial “burst” phase characterised by mean serum leuporelin concentrations of 99.7 and 93.7 ng/mL after approximately 3.7 and 3.8 hours post dosing, respectively, mean serum leuporelin levels maintained relatively constant over each 24-week dosing interval, with leuporelin being continuously released by the third day after dosing with steady serum concentrations (“plateau” phase) through the 24-week (approximately 6-month) dosing interval (mean concentration: 0.37 to 2.97 ng/mL). There is no indication of significant accumulation with repeated leuporelin dosing at 24-week intervals.

The initial acute increase of leuporelin concentrations after CAMCEVI are followed by a rapid decline to a steady state levels.

The pharmacokinetics/pharmacodynamics (as per serum testosterone level) profiles of leuporelin versus serum testosterone level observed after initial injection of CAMCEVI (first dose) and at 24 weeks (second dose) is shown in Figure 2 (study FP01C-13-001; Part II).

Figure 2: Pharmacokinetic/pharmacodynamic response to CAMCEVI

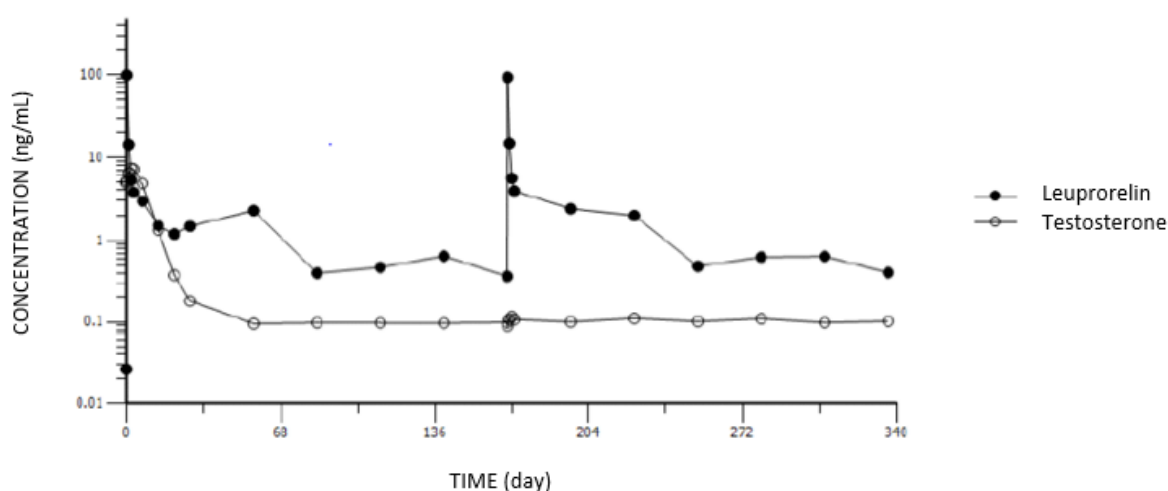

Distribution

The mean steady-state volume of distribution of leuporelin following intravenous bolus administration to healthy male volunteers was 27 litres. *In-vitro* binding to human plasma proteins ranged from 43% to 49%.

Metabolism

No metabolism study was conducted with leuprorelin.

Elimination

In healthy male volunteers, a 1 mg bolus of leuprorelin administered intravenously revealed that the mean systemic clearance was 8.34 L/h, with a terminal elimination half- life of approximately 3 hours based on a two-compartment model.

No excretion studies have been conducted with leuprorelin.

5.3 Preclinical safety data

Preclinical studies with leuprorelin revealed in both sexes effects on the reproductive system, which were expected from the known pharmacological properties. These effects were shown to be reversible after discontinuation of the treatment and an appropriate period of regeneration. Leuprorelin did not show teratogenicity. Embryotoxicity/lethality was observed in rabbits, in line with the pharmacological effects of leuprorelin on the reproductive system.

Consistent with the GnRH agonistic effects of leuprorelin hyperplasia and adenoma were observed in the anterior pituitary of rats.

Carcinogenicity studies were performed in rats and mice over 24 months. In rats, a dose-related increase in pituitary apoplexy was observed after subcutaneous administration at doses of 0.6 to 4 mg/kg/day. No such effect was observed in mice.

Leuprorelin was not mutagenic in a set of *in-vitro* and *in-vivo* assays.

6. PHARMACEUTICAL PARTICULARS

6.1 List of excipients

Poly(D,L-lactide)
N-methylpyrrolidone

6.2 Incompatibilities

Not applicable.

6.3 Shelf life

2 years.

6.4 Special precautions for storage

Store in a refrigerator (2°C – 8°C).
Store in the original package in order to protect from light.

6.5 Nature and contents of container

One pack contains:
1 pre-filled syringe (cyclic olefin copolymer, closed with bromobutyl elastomeric grey tip cap, plunger and finger grip), 1 needle (18 gauge, 5/8 inch) and 1 Point-Lok needle protection device.

6.6 Special precautions for disposal and other handling

Follow the instructions as directed to ensure proper preparation of CAMCEVI prior to administration.

Important: Prior to use allow CAMCEVI to reach room temperature (15 °C to 25 °C). The use of gloves is recommended during administration.

CAMCEVI contains:

- One blister with:
 - One sterile pre-filled syringe;
 - One sterile needle.
- One Point-Lok needle protection device (non-sterile).

Assembled pre-filled syringe, including Point-Lok:

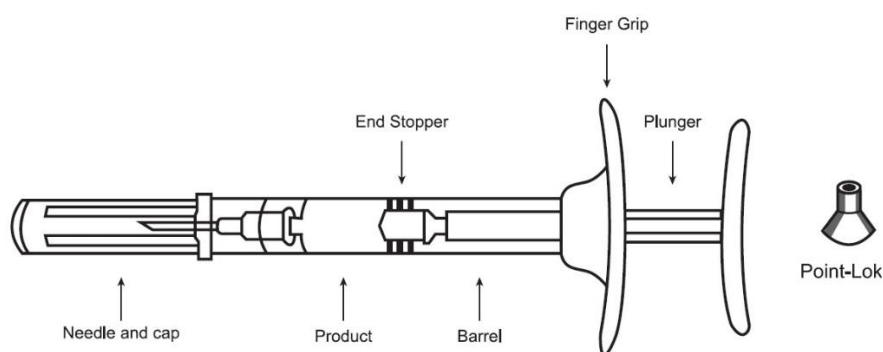

Step 1 - Prepare the medicinal product:

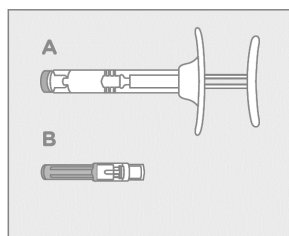

Allow to reach room temperature and inspect contents

- Remove CAMCEVI from refrigerator.
- Prior to use allow CAMCEVI to reach room temperature (15 °C to 25 °C). This takes approximately 15 to 20 minutes.
- On a flat, clean and dry surface open carton and remove pre-filled CAMCEVI syringe (A) and needle protected with a cap (B) from the blister container. Examine all contents of the package. Do not use if any component is damaged.
- Place the Point-Lok needle protection device, supplied within the CAMCEVI, on a secured flat surface.
- Check the expiry date on the syringe. Do not use if the expiry date has passed.
- Visually inspect the medicine prior to use. The pre-filled syringe should contain off-white to pale yellow viscous and opalescent suspension. Do not use if foreign particles are noticed inside the syringe barrel.

Step 2 - Syringe assembly:

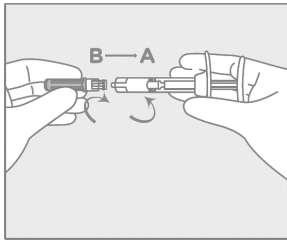
<p>Attach the needle</p> 	<ul style="list-style-type: none"> • Remove the grey cap from the syringe (A). • Twist the clear cap off the bottom of the needle (B). • Attach the needle (B) to the end of the syringe (A) by pushing and turning until firmly connected. Do not over twist the needle and strip the threading to avoid possible breakage and drug leakage. Discard pre-filled CAMCEVI syringe if over-twist causes syringe breakage.
---	--

Step 3 - Administration procedure:

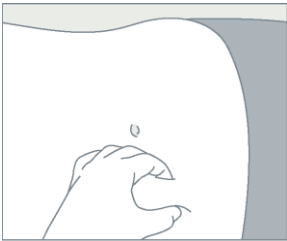
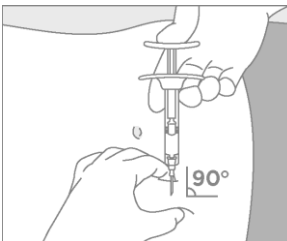
<p>Prepare the injection site</p>  <p>Administer treatment</p> 	<ul style="list-style-type: none"> • Choose an injection site on the upper- or mid-abdominal area with sufficient soft or loose subcutaneous tissue that has not recently been used. The injection site should be varied periodically. • Clean the injection site with an alcohol swab. Do NOT inject in areas with brawny or fibrous subcutaneous tissue or locations that can be rubbed or compressed (i.e., with a belt or clothing waistband). • Pull the blue cover off the needle (B). Grab and bunch the skin around the injection site with one hand. Insert the needle at a 90° angle, then release the bunched skin. • Inject the full contents of the syringe with a slow and steady push, then withdraw the needle at the same 90° angle used for insertion. <p>Intra-arterial or intravenous injection have to be strictly avoided.</p>
---	---

Step 4 - Discard needle and pre-filled syringe

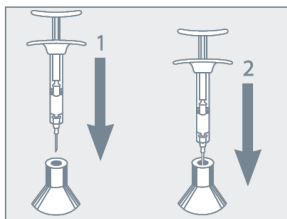
<p>Needle Protection</p> 	<ul style="list-style-type: none"> • Do not remove the needle from the syringe. Use the enclosed Point-Lok device to prevent needle sticks. • Immediately after use of the needle, gently insert the exposed needle into the Point-Lok device opening at top of the device. • Push needle into the top opening until it is firmly inserted into the Point-Lok device. This action will seal the needle tip and lock the needle firmly into the device. • After use, place the used syringe with needle protected in a suitable sharps container. <p>Any unused medicinal product or waste material should be disposed of in accordance with local requirements.</p>
---	---

7. MARKETING AUTHORISATION HOLDER

Accord Healthcare S.L.U.
World Trade Center,
Moll de Barcelona, s/n,
Edifici Est 6^a planta,
08039, Barcelona,
Spain

8. MARKETING AUTHORISATION NUMBER(S)

EU/1/22/1647/001

9. DATE OF FIRST AUTHORISATION/RENEWAL OF THE AUTHORISATION

Date of first authorisation: 24 May 2022

10. DATE OF REVISION OF THE TEXT

Detailed information on this medicinal product is available on the website of the European Medicines Agency <http://www.ema.europa.eu>.

ANNEX II

- A. MANUFACTURER(S) RESPONSIBLE FOR BATCH RELEASE**
- B. CONDITIONS OR RESTRICTIONS REGARDING SUPPLY AND USE**
- C. OTHER CONDITIONS AND REQUIREMENTS OF THE MARKETING AUTHORISATION**
- D. CONDITIONS OR RESTRICTIONS WITH REGARD TO THE SAFE AND EFFECTIVE USE OF THE MEDICINAL PRODUCT**

A. MANUFACTURER(S) RESPONSIBLE FOR BATCH RELEASE

Name and address of the manufacturer(s) responsible for batch release

Accord Healthcare Polska Sp. z.o.o.
Ul. Lutomska 50
95-200, Pabianice
Poland

B. CONDITIONS OR RESTRICTIONS REGARDING SUPPLY AND USE

Medicinal product subject to medical prescription.

C. OTHER CONDITIONS AND REQUIREMENTS OF THE MARKETING AUTHORISATION

- **Periodic safety update reports (PSURs)**

The requirements for submission of PSURs for this medicinal product are set out in the list of Union reference dates (EURD list) provided for under Article 107c(7) of Directive 2001/83/EC and any subsequent updates published on the European medicines web-portal.

D. CONDITIONS OR RESTRICTIONS WITH REGARD TO THE SAFE AND EFFECTIVE USE OF THE MEDICINAL PRODUCT

- **Risk management plan (RMP)**

The marketing authorisation holder (MAH) shall perform the required pharmacovigilance activities and interventions detailed in the agreed RMP presented in Module 1.8.2 of the marketing authorisation and any agreed subsequent updates of the RMP.

An updated RMP should be submitted:

- At the request of the European Medicines Agency;
- Whenever the risk management system is modified, especially as the result of new information being received that may lead to a significant change to the benefit/risk profile or as the result of an important (pharmacovigilance or risk minimisation) milestone being reached.

ANNEX III
LABELLING AND PACKAGE LEAFLET

A. LABELLING

PARTICULARS TO APPEAR ON THE OUTER PACKAGING

CARTON

1. NAME OF THE MEDICINAL PRODUCT

CAMCEVI 42 mg prolonged-release suspension for injection
leuprorelin

2. STATEMENT OF ACTIVE SUBSTANCE(S)

One pre-filled syringe contains leuprorelin mesilate equivalent to 42 mg leuprorelin.

3. LIST OF EXCIPIENTS

Excipients: Poly(D,L-lactide) and N-methylpyrrolidone. See leaflet for further information.

4. PHARMACEUTICAL FORM AND CONTENTS

Prolonged-release suspension for injection

This pack contains:

- One pre-filled syringe
- One needle
- One needle protection device

5. METHOD AND ROUTE(S) OF ADMINISTRATION

Read the package leaflet before use.

Single use only.

Use every 6 months

Subcutaneous use.

6. SPECIAL WARNING THAT THE MEDICINAL PRODUCT MUST BE STORED OUT OF THE SIGHT AND REACH OF CHILDREN

Keep out of the sight and reach of children.

7. OTHER SPECIAL WARNING(S), IF NECESSARY

8. EXPIRY DATE

EXP

9. SPECIAL STORAGE CONDITIONS

Store in a refrigerator.
Store in the original package in order to protect from light.

10. SPECIAL PRECAUTIONS FOR DISPOSAL OF UNUSED MEDICINAL PRODUCTS OR WASTE MATERIALS DERIVED FROM SUCH MEDICINAL PRODUCTS, IF APPROPRIATE

11. NAME AND ADDRESS OF THE MARKETING AUTHORISATION HOLDER

Accord Healthcare S.L.U.
World Trade Center,
Moll de Barcelona, s/n,
Edifici Est 6^a planta,
08039, Barcelona,
Spain

12. MARKETING AUTHORISATION NUMBER(S)

EU/1/22/1647/001

13. BATCH NUMBER

Lot

14. GENERAL CLASSIFICATION FOR SUPPLY

15. INSTRUCTIONS ON USE

16. INFORMATION IN BRAILLE

Camcevi

17. UNIQUE IDENTIFIER – 2D BARCODE

2D barcode carrying the unique identifier included.

18. UNIQUE IDENTIFIER – HUMAN READABLE DATA

PC
SN
NN

MINIMUM PARTICULARS TO APPEAR ON BLISTERS OR STRIPS

SYRINGE BLISTER

1. NAME OF THE MEDICINAL PRODUCT

CAMCEVI 42 mg prolonged-release suspension for injection
leuprorelin
SC

2. NAME OF THE MARKETING AUTHORISATION HOLDER

accord

3. EXPIRY DATE

EXP

4. BATCH NUMBER

Lot

5. OTHER

**MINIMUM PARTICULARS TO APPEAR ON SMALL IMMEDIATE PACKAGING UNITS
SYRINGE LABEL**

1. NAME OF THE MEDICINAL PRODUCT AND ROUTE(S) OF ADMINISTRATION

CAMCEVI 42 mg prolonged-release suspension for injection
leuprorelin
SC

2. METHOD OF ADMINISTRATION

Subcutaneous use

3. EXPIRY DATE

EXP

4. BATCH NUMBER

Lot

5. CONTENTS BY WEIGHT, BY VOLUME OR BY UNIT

6. OTHER

B. PACKAGE LEAFLET

Package leaflet: Information for the user

CAMCEVI 42 mg prolonged-release suspension for injection leuprorelin

Read all of this leaflet carefully before you start using this medicine because it contains important information for you.

- Keep this leaflet. You may need to read it again.
- If you have any further questions, ask your doctor, pharmacist or nurse.
- If you get any side effects, talk to your doctor, pharmacist or nurse. This includes any possible side effects not listed in this leaflet. See section 4.

What is in this leaflet

1. What CAMCEVI is and what it is used for
2. What you need to know before you are given CAMCEVI
3. How you will be given CAMCEVI
4. Possible side effects
5. How to store CAMCEVI
6. Contents of the pack and other information

1. What CAMCEVI is and what it is used for

The active substance of CAMCEVI is leuprorelin which is a GnRH-agonist (a synthetic version of a natural hormone called gonadotropin releasing hormone) and acts in the same way as the natural hormone to lower the level of the sex hormone testosterone in the body.

Prostate cancer is sensitive to hormones such as testosterone, and reducing testosterone levels helps control the growth of the cancer.

CAMCEVI is used to treat adult men who have:

- hormone dependent metastatic prostate cancer and
- high-risk non-metastatic hormone dependent prostate cancer in combination with radiotherapy.

2. What you need to know before you are given CAMCEVI

DO NOT use CAMCEVI:

- if you are a **woman or a child under the age of 18**;
- if you are **allergic** to leuprorelin, or to similar medicines that affect your sex hormones (GnRH agonists); your doctor will help you identify these if necessary,
- if you are allergic to any of the other ingredients of this medicine (listed in section 6);
- following **surgical removal of your testicles**. This medicine cannot further help to lower your testosterone levels once you have no testicles;
- as the only treatment if you suffer from symptoms related to pressure on the spinal cord or a tumour in the spinal column. In this case, CAMCEVI may only be used in combination with other medicines for prostate cancer.

Warnings and precautions

Seek urgent medical attention if you develop:

- sudden headache;
- vomiting;
- loss of, or double vision;
- loss of the ability to move the muscles in, or around, your eye;

- altered mental state;
- early symptoms of heart failure including
 - o fatigue
 - o swelling in your ankles;
 - o increased need to urinate at night;
 - o more severe symptoms such as rapid breathing, chest pain, and fainting.

These may be signs of a condition called pituitary apoplexy, involving bleeding into, or impaired blood supply to the pituitary gland found at the base of the brain. Pituitary apoplexy can occur due to a tumor of the pituitary and can emerge rarely after starting treatment. Most cases occur within 2 weeks of the first dose, and some within the first hour.

Talk to your doctor, pharmacist or nurse before using CAMCEVI if you

- develop cardiovascular signs and symptoms such as fast chaotic heartbeats. These rapid heartbeats might cause you to faint or have fits (seizures);
- have heart or blood vessel conditions, including heart rhythm problems (arrhythmia), or are taking medicines for these conditions. The risk of these heart rhythm problems may get worse when using CAMCEVI. Your doctor may monitor your heart using an electrocardiogram (ECG);
- have prostate cancer which has spread into your spine or brain. Your doctor will monitor you more closely during first few weeks of treatment;
- suffer from diabetes mellitus (high blood sugar levels). CAMCEVI can make existing diabetes worse and therefore people with diabetes need more frequent testing of blood glucose levels.

Talk to your doctor, pharmacist or nurse during treatment with CAMCEVI if you

- experience a heart attack. Symptoms include chest pain, shortness of breath, dizziness and sweating;
- suffer from a stroke. Symptoms include your face dropping on one side, not being able to lift your arms and slurred speech;
- develop a bone fracture. Treatment with CAMCEVI can increase the risk for fractures due to osteoporosis (decrease in bone density);
- have a fit (convulsions);
- notice your blood sugar levels go up. Your doctor will monitor your blood glucose levels during treatment;
- have difficulty urinating. There could be a blockage in your urinary tube. Your doctor will closely monitor you during the first weeks of treatment;
- develop symptoms of spinal compression such as pain, numbness, or weakness in the arms, hands, legs, or feet. Your doctor will closely monitor you during your first few weeks of treatment.

Problems you may experience during the first weeks of treatment

During the first weeks of treatment, there is generally a brief increase in the male sex hormone testosterone in the blood. This can lead to a temporary worsening in disease-related symptoms and also to new symptoms that you may not have experienced before. These especially include:

- bone pain;
- problems with urinating, pain, numbness, or weakness in the arms, hands, legs, or feet, or loss of bladder or bowel control as a result of spinal compression;
- blood in your urine.

These symptoms usually lessen with ongoing treatment. If not, you should contact your doctor.

You may be given another medicine before starting CAMCEVI to help lessen the initial rise of testosterone in your blood. You may remain on this other medicine for a few weeks of CAMCEVI treatment.

If CAMCEVI does not help

Some patients have tumours, that are not sensitive to lower levels of testosterone. Please talk to your

doctor if you think that the effect of CAMCEVI is too weak.

Other medicines and CAMCEVI

Tell your doctor or pharmacist if you are taking, have recently taken or might take any other medicines.

CAMCEVI might interfere with some medicines used to treat heart rhythm problems (e.g. quinidine, procainamide, amiodarone, sotalol, dofetilide and ibutilide) or might increase the risk of heart rhythm problems when used with some other medicines, such as methadone (used for pain relief and used as heroin substitute when treating drug addicts), moxifloxacin (an antibiotic), and antipsychotic medicines used for serious mental illnesses.

Pregnancy and breast-feeding

This medicine is not intended for women.

Driving and using machines

Tiredness, dizziness and visual disturbances may occur in people being treated with CAMCEVI. If you suffer from any of these side effects, do not drive, use tools or operate machines.

3. How you will be given CAMCEVI

You will be given CAMCEVI as a single injection under your skin (subcutaneous), once every 6 months, by your doctor or nurse.

This medicine should only be given to you by your doctor or a nurse, who will ensure it is injected properly under the skin and not into a vein.

After injection the medicine becomes solid, and then slowly releases leuprorelin into your body over a 6-month period.

In combination with radiotherapy

This medicine can be used before or at the same time as radiotherapy treatment for high-risk localised and locally advanced prostate cancer. High-risk localised means that the cancer is likely to spread beyond the prostate gland to nearby tissues, becoming locally advanced. Locally advanced means that the cancer has spread beyond the pelvis to nearby tissues such as lymph nodes.

Monitoring your treatment

Your doctor will monitor your response to treatment with blood tests, including prostate-specific antigen (PSA).

If you receive more CAMCEVI than you should

Since the injection is given to you by your doctor or appropriately trained staff, an overdose is unlikely. If you inadvertently receive too much medicine, your doctor will monitor you and give you additional treatment as required.

If a dose of CAMCEVI is forgotten

Talk to your doctor if you believe that your six monthly dose of CAMCEVI has been forgotten.

Effects when treatment with CAMCEVI is stopped

As a general rule, the therapy for prostate cancer with CAMCEVI requires long-term treatment. Therefore, therapy should not be stopped too soon, even if you see your symptoms improve or if they disappear completely. If the treatment is stopped too early, your symptoms may return. Do not stop the treatment early without talking with your doctor first.

If you have any further questions on the use of this medicine, ask your doctor, pharmacist or nurse.

4. Possible side effects

Like all medicines, this medicine can cause side effects, although not everybody gets them.

Seek urgent medical attention if you develop:

- sudden headache;
- vomiting;
- loss of, or double vision;
- loss of the ability to move the muscles in, or around, your eye;
- altered mental state;
- early symptoms of heart failure including
 - o fatigue
 - o swelling in your ankles;
 - o increased need to urinate at night;
 - o more severe symptoms such as rapid breathing, chest pain, and fainting.

These may be signs of a condition called pituitary apoplexy, involving bleeding into, or impaired blood supply to the pituitary gland found at the base of the brain. Pituitary apoplexy can occur due to a tumor of the pituitary and can emerge rarely after starting treatment. Most cases occur within 2 weeks of the first dose, and some within the first hour.

Initial side effects

During the first week of treatment, there is generally a brief increase in the male sex hormone testosterone in the blood. This can lead to a temporary worsening in the disease-related symptoms and also to new symptoms that you may not have experienced before. These especially include:

- bone pain;
- problems with urinating, pain, numbness, or weakness in the arms, hands, legs, or feet, or loss of bladder or bowel control, which may be symptoms of spinal compression;
- blood in your urine.

Your doctor may give you another medicine at the beginning of the treatment to reduce some of these initial side effects (See also section 2 Problems you may experience during first weeks of treatment).

Side effects at injection site

You may experience the following side effects around the injection site, after your injection:

- mild burning and numbness immediately after the injection (very common: may affect more than 1 in 10 people)
- pain, bruising and stinging after the injection (common: may affect up to 1 in 10 people)
- itchiness and hardening of skin around injection site (uncommon: may affect up to 1 in 100 people)
- damage or sore on the skin at injection site (rare: may affect up to 1 in 1,000 people);
dead tissue at injection site (very rare, may affect up to 1 in 10,000 people).

These side effects are mild and do not last very long. They only occur at the time of your injection. If you get any of these side effects, talk to your doctor.

Very common side effects (may affect more than 1 in 10 people)

- hot flashes;
- bruising and/or redness of the skin;
- tiredness.

Common side effects (may affect up to 1 in 10 people)

- symptoms of common cold (nasopharyngitis)
- feeling sick (nausea), diarrhoea, inflammation of the stomach and intestines (gastroenteritis/colitis)
- itching
- night sweats
- joint pain, pain in arms and legs, muscle aches and pains

- needing to urinate more than normal, including during the night, difficulty in urinating, pain when urinating, not urinating enough or needing to urinate less frequently;
- tenderness and/or swelling of the breast, shrinking of testicles, pain in testicles, infertility, erectile dysfunction, reduced penis size;
- episodes of exaggerated shaking with high fever (rigors), weakness, generally feeling unwell (malaise)
- changes in blood laboratory results (prolonged bleeding time, changes in blood values, decreased red blood cells/low red blood cell count).

Uncommon side effects (may affect up to 1 in 100 people)

- urinary tract infection (UTI), local skin infection
- worsening of diabetes mellitus
- abnormal dreams, depression, decreased libido (sexual desire)
- dizziness, headache, partial or total loss of sensation in a part of your body, insomnia, abnormal change in taste and/or smell
- light-headedness and loss of balance (vertigo)
- changes in electrocardiogram (ECG) (QT prolongation)
- heart attack. Symptoms include chest pain, shortness of breath, dizziness and sweating
- high or low blood pressure;
- runny nose shortness of breath
- constipation, dry mouth, disturbed digestion, with symptoms as full stomach, pain in the stomach, belching, nausea, vomiting, burning feeling in the stomach (dyspepsia), being sick (vomiting)
- feeling clammy and sweaty;
- back pain, muscle cramps;
- bladder spasms, blood in urine, over-active bladder (need to urinate before your bladder is full), unable to urinate;
- enlarged breasts, impotence, problems with testicles (e.g. swollen, red or warm scrotum, pain or discomfort in pelvic area)
- sleepiness (lethargy), pain, fever
- changes in blood laboratory tests weight gain

Rare side effects (may affect up to 1 in 1,000 people)

- body moves in an uncontrollable and unintended way;
- fainting, collapsing;
- passing wind and burping;
- hair loss, pimples on skin;
- breast pain

Not known (frequency cannot be estimated from the available data)

- inflammation of lungs (interstitial lung disease)
- idiopathic intracranial hypertension (increased intracranial pressure around the brain characterised by headache, double vision and other visual symptoms and ringing or buzzing in one or both ears).

The following serious allergic reactions have been reported with medicines in the same group of medicines as CAMCEVI

- difficulty in breathing or dizziness (rarely).

The following side effects have been reported with other medicines containing leuprorelin

- swelling of hands and feet (oedema);
- symptoms of a pulmonary embolism (a blood clot in the vessels supplying the lungs), including chest pain, breathlessness, difficulty breathing and coughing up blood;
- a noticeably rapid, strong, or irregular heartbeat;
- weak muscles;

- chills;
- rash;
- impaired memory;
- impaired vision;
- muscle wasting/loss of muscle tissue after prolonged use.
- medical condition in which the bones become brittle and fragile called osteoporosis, and therefore there is a higher risk of bone fractures.

The following side effect has been reported with medicines in the same group of medicines as CAMCEVI

- seizures.

Reporting of side effects

If you get any side effects, talk to your doctor, pharmacist or nurse. This includes any possible side effects not listed in this leaflet. You can also report side effects directly via the national reporting system listed in [Appendix V](#). By reporting side effects, you can help provide more information on the safety of this medicine.

5. How to store CAMCEVI

Keep this medicine out of the sight and reach of children.

Do not use this medicine after the expiry date which is stated on the outer packaging after EXP. The expiry date refers to the last day of that month.

Store in a refrigerator (2°C – 8°C).

Store in the original package in order to protect from light.

Prior to use allow CAMCEVI to reach room temperature (15 °C to 25 °C). This takes approximately 15 to 20 minutes.

Do not throw away any medicines via wastewater or household waste. Ask your pharmacist how to throw away medicines you no longer use. These measures will help protect the environment.

6. Contents of the pack and other information

What CAMCEVI contains

- The active substance is leuprorelin. One pre-filled syringe with prolonged-release suspension for injection contains leuprorelin mesilate equivalent to 42 mg leuprorelin.
- The other ingredients are Poly(D,L-lactide) and N-methylpyrrolidone.

What CAMCEVI looks like and contents of the pack

CAMCEVI is a prolonged-release suspension for injection. The pre-filled syringe has an off-white to pale yellow viscous and opalescent suspension.

CAMCEVI is available in a pack containing: 1 pre-filled syringe, 1 needle and 1 Point-Lok needle protection device.

Marketing Authorisation Holder

Accord Healthcare S.L.U.
World Trade Center,
Moll de Barcelona, s/n,
Edifici Est 6^a planta,
08039, Barcelona,
Spain

Manufacturer

Accord Healthcare Polska Sp. z o.o.
Ul. Lutomska 50
95-200, Pabianice
Poland

This leaflet was last revised in

Detailed information on this medicine is available on the European Medicines Agency web site:
<http://www.ema.europa.eu>.

The following information is intended for healthcare professionals only:

Follow the instructions as directed to ensure proper preparation of CAMCEVI prior to administration.

Important: Prior to use allow CAMCEVI to reach room temperature (15 °C to 25 °C). The use of gloves is recommended during administration.

CAMCEVI contains:

- One blister with:
 - One sterile pre-filled syringe;
 - One sterile needle.
- One Point-Lok needle protection device (non-sterile).

Assembled pre-filled syringe, including Point-Lok:

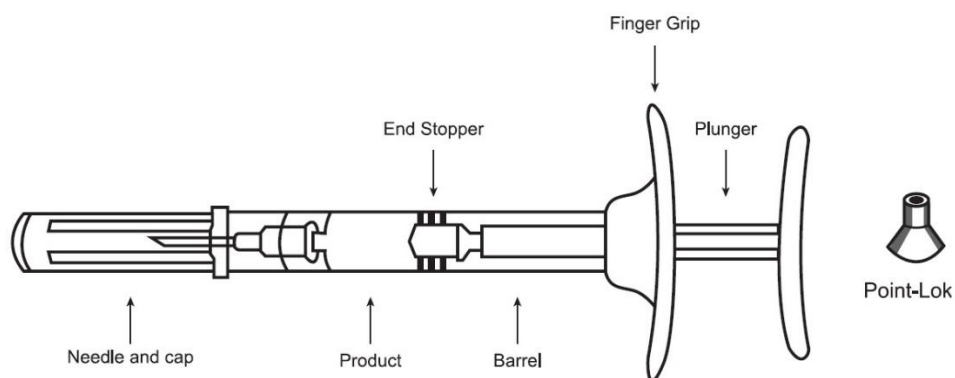

Step 1 - Prepare the medicinal product:

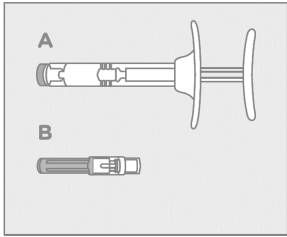
	<p>Allow to reach room temperature and inspect contents</p> <ul style="list-style-type: none">• Remove CAMCEVI from refrigerator.• Prior to use allow CAMCEVI to reach room temperature (15 °C to 25 °C). This takes approximately 15 to 20 minutes.• On a flat, clean and dry surface open carton and remove pre-filled CAMCEVI syringe (A) and needle protected with a cap (B) from the blister container. Examine all contents of the package. Do not use if any component is damaged.• Place the Point-Lok needle protection device, supplied within the CAMCEVI, on a secured flat surface.• Check the expiry date on the syringe. Do not use if the expiry date has passed.• Visually inspect the medicine prior to use. The pre-filled syringe should contain off-white to pale yellow viscous and opalescent suspension. Do not use if foreign particle is noticed inside the syringe barrel.
---	---

Step 2 - Syringe assembly:

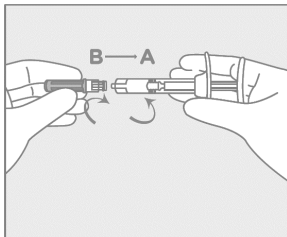
<p>Attach the needle</p> 	<ul style="list-style-type: none">• Remove the grey cap from the syringe (A).• Twist the clear cap off the bottom of the needle (B).• Attach the needle (B) to the end of the syringe (A) by pushing and turning until firmly connected. Do not over twist the needle and strip the threading to avoid possible breakage and drug leakage. Discard pre-filled CAMCEVI syringe if over-twist causes syringe breakage.
---	--

Step 3 - Administration procedure:

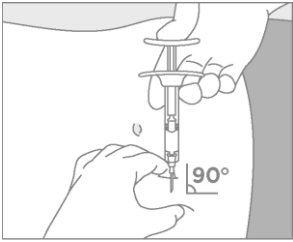
<p>Prepare the injection site</p>  <p>Administer treatment</p> 	<ul style="list-style-type: none">• Choose an injection site on the upper- or mid-abdominal area with sufficient soft or loose subcutaneous tissue that has not recently been used. The injection site should be varied periodically.• Clean the injection site with an alcohol swab. Do NOT inject in areas with brawny or fibrous subcutaneous tissue or locations that can be rubbed or compressed (i.e., with a belt or clothing waistband).• Pull the blue cover off the needle (B). Grab and bunch the skin around the injection site with one hand. Insert the needle at a 90° angle, then release the bunched skin.• Inject the full contents of the syringe with a slow and steady push, then withdraw the needle at the same 90° angle used for insertion. <p>Intra-arterial or intravenous injection have to be strictly avoided.</p>
---	--

Step 4 - Discard needle and pre-filled syringe

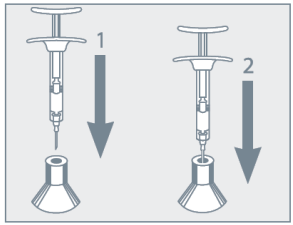
<p>Needle Protection</p> 	<ul style="list-style-type: none">• Do not remove the needle from the syringe. Use the enclosed Point-Lok device to prevent needle sticks.• Immediately after use of the needle, gently insert the exposed needle into the Point-Lok device opening at top of the device.• Push needle into the top opening until it is firmly inserted into the Point-Lok device. This action will seal the needle tip and lock the needle firmly into the device.• After use, place the used syringe with needle protected in a suitable sharps container. <p>Any unused medicinal product or waste material should be disposed of in accordance with local requirements.</p>
---	--