

ANNEX I
SUMMARY OF PRODUCT CHARACTERISTICS

1. NAME OF THE MEDICINAL PRODUCT

NovoRapid 100 units/ml solution for injection in vial
NovoRapid Penfill 100 units/ml solution for injection in cartridge
NovoRapid FlexPen 100 units/ml solution for injection in pre-filled pen
NovoRapid InnoLet 100 units/ml solution for injection in pre-filled pen
NovoRapid FlexTouch 100 units/ml solution for injection in pre-filled pen
NovoRapid PumpCart 100 units/ml solution for injection in cartridge

2. QUALITATIVE AND QUANTITATIVE COMPOSITION

NovoRapid vial

1 vial contains 10 ml equivalent to 1,000 units. 1 ml solution contains 100 units insulin aspart* (equivalent to 3.5 mg).

NovoRapid Penfill

1 cartridge contains 3 ml equivalent to 300 units. 1 ml solution contains 100 units insulin aspart* (equivalent to 3.5 mg).

NovoRapid FlexPen/NovoRapid InnoLet/NovoRapid FlexTouch

1 pre-filled pen contains 3 ml equivalent to 300 units. 1 ml solution contains 100 units insulin aspart* (equivalent to 3.5 mg).

NovoRapid PumpCart

1 cartridge contains 1.6 ml equivalent to 160 units. 1 ml solution contains 100 units insulin aspart* (equivalent to 3.5 mg).

*Insulin aspart is produced in *Saccharomyces cerevisiae* by recombinant DNA technology.

For the full list of excipients, see section 6.1.

3. PHARMACEUTICAL FORM

Solution for injection.

The solution is clear, colourless and aqueous.

4. CLINICAL PARTICULARS

4.1 Therapeutic indications

NovoRapid is indicated for treatment of diabetes mellitus in adults, adolescents and children aged 1 year and above.

4.2 Posology and method of administration

Posology

The potency of insulin analogues, including insulin aspart, is expressed in units, whereas the potency of human insulin is expressed in international units.

NovoRapid dosing is individual and determined in accordance with the needs of the patient. It should normally be used in combination with intermediate-acting or long-acting insulin.

Moreover NovoRapid vial and NovoRapid PumpCart can be used for continuous subcutaneous insulin infusion (CSII) in pump systems.

NovoRapid vial can also be used if intravenous administration of insulin aspart, by physicians or other healthcare staff, is applicable.

Blood glucose monitoring and insulin dose adjustments are recommended to achieve optimal glycaemic control.

The individual insulin requirement in adults and children is usually between 0.5 and 1.0 unit/kg/day. In a basal-bolus treatment regimen 50–70% of this requirement may be provided by NovoRapid and the remainder by intermediate-acting or long-acting insulin.

Adjustment of dose may be necessary if patients undertake increased physical activity, change their usual diet or during concomitant illness.

Special populations

Elderly (≥ 65 years old)

NovoRapid can be used in elderly patients.

In elderly patients, glucose monitoring should be intensified and the insulin aspart dose adjusted on an individual basis.

Renal and hepatic impairment

Renal or hepatic impairment may reduce the patient's insulin requirements.

In patients with renal or hepatic impairment, glucose monitoring should be intensified and the insulin aspart dose adjusted on an individual basis.

Paediatric population

NovoRapid can be used in children and adolescents aged 1 year and above in preference to soluble human insulin when a rapid onset of action might be beneficial, for example, in the timing of the injections in relation to meals (see sections 5.1 and 5.2).

The safety and efficacy of NovoRapid in children below 1 year of age have not been established. No data are available.

Transfer from other insulin medicinal products

When transferring from other insulin medicinal products, adjustment of the NovoRapid dose and the dose of the basal insulin may be necessary. NovoRapid has a faster onset and a shorter duration of action than soluble human insulin. When injected subcutaneously into the abdominal wall, the onset of action will occur within 10–20 minutes of injection. The maximum effect is exerted between 1 and 3 hours after the injection. The duration of action is 3 to 5 hours.

Close glucose monitoring is recommended during the transfer and in the initial weeks thereafter (see section 4.4).

Method of administration

NovoRapid is a rapid-acting insulin analogue.

NovoRapid is administered subcutaneously by injection in the abdominal wall, the thigh, the upper arm, the deltoid region or the gluteal region. Injection sites should always be rotated within the same region in order to reduce the risk of lipodystrophy and cutaneous amyloidosis (see sections 4.4 and 4.8). Subcutaneous injection in the abdominal wall ensures a faster absorption than other injection sites. Compared to soluble human insulin the faster onset of action of NovoRapid is maintained regardless of the injection site. The duration of action will vary according to the dose, injection site, blood flow, temperature and level of physical activity.

Due to the faster onset of action, NovoRapid should generally be given immediately before a meal. When necessary NovoRapid can be given soon after a meal.

NovoRapid vial/NovoRapid PumpCart

Continuous Subcutaneous Insulin Infusion (CSII)

NovoRapid may be used for CSII in pump systems suitable for insulin infusion. CSII should be administered in the abdominal wall. Infusion sites should be rotated.

When used with an insulin infusion pump, NovoRapid should not be mixed with any other insulin medicinal products.

Patients using CSII should be comprehensively instructed in the use of the pump system and use the correct reservoir and tubing for the pump (see section 6.6). The infusion set (tubing and cannula) should be changed in accordance with the instructions in the product information supplied with the infusion set.

Patients administering NovoRapid by CSII must have an alternative insulin delivery method available in case of pump system failure.

NovoRapid vial

Intravenous use

If necessary, NovoRapid can be administered intravenously which should be carried out by physicians or other healthcare staff.

For intravenous use, infusion systems with NovoRapid 100 units/ml at concentrations from 0.05 unit/ml to 1.0 unit/ml insulin aspart in the infusion fluids 0.9% sodium chloride, 5% dextrose or 10% dextrose including 40 mmol/l potassium chloride using polypropylene infusion bags, are stable at room temperature for 24 hours.

Although stable over time, a certain amount of insulin will be initially adsorbed to the material of the infusion bag. Monitoring of blood glucose is necessary during insulin infusion.

Mixing two types of insulins

NovoRapid can only be mixed with NPH (Neutral Protamine Hagedorn) insulin in a syringe for subcutaneous use. When NovoRapid is mixed with NPH insulin, NovoRapid should be drawn into the syringe first, and the mixture should be injected immediately after mixing. Insulin mixtures should not be administered intravenously or used with a subcutaneous insulin infusion pump.

Administration with a syringe

NovoRapid vials are for use with insulin syringes with the corresponding unit scale. See also section 6.2.

NovoRapid Penfill

Administration with an insulin delivery system

NovoRapid Penfill is designed to be used with Novo Nordisk insulin delivery systems and NovoFine or NovoTwist needles. NovoRapid Penfill is only suitable for subcutaneous injections from a reusable pen. If administration by syringe or intravenous injection is necessary, a vial should be used. If administration by infusion pump is necessary, a vial or NovoRapid PumpCart should be used.

NovoRapid FlexPen

Administration with FlexPen

NovoRapid FlexPen is a pre-filled pen (colour-coded) designed to be used with NovoFine or NovoTwist disposable needles up to a length of 8 mm. FlexPen delivers 1–60 units in increments of 1 unit. NovoRapid FlexPen is only suitable for subcutaneous injections. If administration by syringe or intravenous injection is necessary, a vial should be used. If administration by infusion pump is necessary, a vial or NovoRapid PumpCart should be used.

NovoRapid InnoLet

Administration with InnoLet

NovoRapid InnoLet is a pre-filled pen designed to be used with NovoFine or NovoTwist disposable needles up to a length of 8 mm. InnoLet delivers 1–50 units in increments of 1 unit. NovoRapid InnoLet is only suitable for subcutaneous injections. If administration by syringe or intravenous injection is necessary, a vial should be used. If administration by infusion pump is necessary, a vial or NovoRapid PumpCart should be used.

NovoRapid FlexTouch

Administration with FlexTouch

NovoRapid FlexTouch is a pre-filled pen (colour-coded) designed to be used with NovoFine or NovoTwist disposable needles up to a length of 8 mm. FlexTouch delivers 1–80 units in increments of 1 unit. NovoRapid FlexTouch is only suitable for subcutaneous injections. If administration by syringe or intravenous injection is necessary, a vial should be used. If administration by infusion pump is necessary, a vial or NovoRapid PumpCart should be used.

NovoRapid PumpCart

Administration via Continuous Subcutaneous Insulin Infusion (CSII)

NovoRapid PumpCart is only for use with an insulin infusion pump system designed to be used with this cartridge, such as the Accu-Chek Insight and YpsoPump insulin pumps.

CSII should be administered in the abdominal wall. Infusion sites should be rotated. NovoRapid PumpCart is only suitable for CSII in pump systems suitable for insulin infusion. If administration by syringe or intravenous injection is necessary, a vial should be used.

For detailed user instructions, please refer to the package leaflet.

4.3 Contraindications

Hypersensitivity to the active substance or to any of the excipients (see section 6.1).

4.4 Special warnings and precautions for use

Before travelling between different time zones, the patient should seek the doctor's advice since this may mean that the patient has to take the insulin and meals at different times.

NovoRapid PumpCart

Misuse of NovoRapid PumpCart

NovoRapid PumpCart is only for use with an insulin infusion pump system designed to be used with this cartridge, such as the Accu-Chek Insight and YpsoPump insulin pumps. It must not be used with other devices not designed for NovoRapid PumpCart, as this may result in incorrect insulin dosing and subsequent hyper- or hypoglycaemia.

Hyperglycaemia

Inadequate dosing or discontinuation of treatment, especially in type 1 diabetes, may lead to hyperglycaemia and diabetic ketoacidosis. Usually the first symptoms of hyperglycaemia develop gradually over a period of hours or days. They include thirst, increased frequency of urination, nausea, vomiting, drowsiness, flushed dry skin, dry mouth, loss of appetite as well as acetone odour of breath. In type 1 diabetes, untreated hyperglycaemic events eventually lead to diabetic ketoacidosis, which is potentially lethal.

Hypoglycaemia

Omission of a meal or unplanned, strenuous physical exercise may lead to hypoglycaemia. Especially in children, care should be taken to match insulin doses (especially in basal-bolus regimens) with food intake, physical activities and current blood glucose level in order to minimise the risk of hypoglycaemia.

Hypoglycaemia may occur if the insulin dose is too high in relation to the insulin requirement. In case of hypoglycaemia or if hypoglycaemia is suspected NovoRapid must not be injected. After stabilisation of patient's blood glucose adjustment of the dose should be considered (see sections 4.8 and 4.9).

Patients whose blood glucose control is greatly improved, e.g. by intensified insulin therapy, may experience a change in their usual warning symptoms of hypoglycaemia, and should be advised accordingly. Usual warning symptoms may disappear in patients with longstanding diabetes.

A consequence of the pharmacodynamics of rapid-acting insulin analogues is that if hypoglycaemia occurs, it may occur earlier after an injection when compared with soluble human insulin.

Since NovoRapid should be administered in immediate relation to a meal, the rapid onset of action should be considered in patients with concomitant diseases or treatment where a delayed absorption of food might be expected.

Concomitant illness, especially infections and feverish conditions, usually increases the patient's insulin requirements. Concomitant diseases in the kidney, liver or affecting the adrenal, pituitary or thyroid gland can require changes in the insulin dose.

When patients are transferred between different types of insulin medicinal products, the early warning symptoms of hypoglycaemia may change or become less pronounced than those experienced with their previous insulin.

Transfer from other insulin medicinal products

Transferring a patient to another type or brand of insulin should be done under strict medical supervision. Changes in strength, brand (manufacturer), type, origin (animal, human insulin or human insulin analogue) and/or method of manufacture (recombinant DNA versus animal source insulin) may result in the need for a change in dose. Patients transferred to NovoRapid from another type of insulin may require an increased number of daily injections or a change in dose from that used with their usual insulin medicinal products. If an adjustment is needed, it may occur with the first dose or during the first few weeks or months.

Injection site reactions

As with any insulin therapy, injection site reactions may occur and include pain, redness, hives, inflammation, bruising, swelling and itching. Continuous rotation of the injection site within a given area reduces the risk of developing these reactions. Reactions usually resolve in a few days to a few weeks. On rare occasions, injection site reactions may require discontinuation of NovoRapid.

Skin and subcutaneous tissue disorders

Patients must be instructed to perform continuous rotation of the injection site to reduce the risk of developing lipodystrophy and cutaneous amyloidosis. There is a potential risk of delayed insulin absorption and worsened glycaemic control following insulin injections at sites with these reactions. A sudden change in the injection site to an unaffected area has been reported to result in hypoglycaemia. Blood glucose monitoring is recommended after the change in the injection site from an affected to an unaffected area, and dose adjustment of antidiabetic medications may be considered.

Combination of NovoRapid with pioglitazone

Cases of cardiac failure have been reported when pioglitazone was used in combination with insulin, especially in patients with risk factors for development of cardiac heart failure. This should be kept in mind if treatment with the combination of pioglitazone and NovoRapid is considered. If the combination is used, patients should be observed for signs and symptoms of heart failure, weight gain and oedema. Pioglitazone should be discontinued if any deterioration in cardiac symptoms occurs.

Avoidance of accidental mix-ups/medication errors

Patients must be instructed to always check the insulin label before each injection to avoid accidental mix-ups between NovoRapid and other insulin products.

Insulin antibodies

Insulin administration may cause insulin antibodies to form. In rare cases, the presence of such insulin antibodies may necessitate adjustment of the insulin dose in order to correct a tendency to hyper- or hypoglycaemia.

Traceability

In order to improve the traceability of biological medicinal products, the name and the batch number of the administered product should be clearly recorded.

4.5 Interaction with other medicinal products and other forms of interaction

A number of medicinal products are known to interact with the glucose metabolism.

The following substances may reduce the patient's insulin requirements:

Oral antidiabetic medicinal products, monoamine oxidase inhibitors (MAOI), beta-blockers, angiotensin converting enzyme (ACE) inhibitors, salicylates, anabolic steroids and sulphonamides.

The following substances may increase the patient's insulin requirements:

Oral contraceptives, thiazides, glucocorticoids, thyroid hormones, sympathomimetics, growth hormone and danazol.

Beta-blockers may mask the symptoms of hypoglycaemia.

Octreotide/lanreotide may either increase or decrease the insulin requirement.

Alcohol may intensify or reduce the hypoglycaemic effect of insulin.

4.6 Fertility, pregnancy and lactation

Pregnancy

NovoRapid (insulin aspart) can be used in pregnancy. Data from two randomised controlled clinical trials (322 and 27 exposed pregnancies) do not indicate any adverse effect of insulin aspart on pregnancy or on the health of the foetus/newborn when compared to human insulin (see section 5.1).

Intensified blood glucose control and monitoring of pregnant women with diabetes (type 1 diabetes, type 2 diabetes or gestational diabetes) are recommended throughout pregnancy and when contemplating pregnancy. Insulin requirements usually fall in the first trimester and increase subsequently during the second and third trimester. After delivery, insulin requirements normally return rapidly to pre-pregnancy values.

Breast-feeding

There are no restrictions on treatment with NovoRapid during breast-feeding. Insulin treatment of the nursing mother presents no risk to the baby. However, the NovoRapid dose may need to be adjusted.

Fertility

Animal reproduction studies have not revealed any differences between insulin aspart and human insulin regarding fertility.

4.7 Effects on ability to drive and use machines

The patient's ability to concentrate and react may be impaired as a result of hypoglycaemia. This may constitute a risk in situations where these abilities are of special importance (e.g. driving a car or operating machinery).

Patients should be advised to take precautions to avoid hypoglycaemia while driving. This is particularly important in those who have reduced or absent awareness of the warning signs of hypoglycaemia or have frequent episodes of hypoglycaemia. The advisability of driving should be considered in these circumstances.

4.8 Undesirable effects

Summary of the safety profile

Adverse reactions observed in patients using NovoRapid are mainly due to the pharmacologic effect of insulin.

The most frequently reported adverse reaction during treatment is hypoglycaemia. The frequencies of hypoglycaemia vary with patient population, dose regimens and level of glycaemic control (see section 4.8, Description of selected adverse reactions).

At the beginning of the insulin treatment, refraction anomalies, oedema and injection site reactions (pain, redness, hives, inflammation, bruising, swelling and itching at the injection site) may occur. These reactions are usually of transitory nature. Fast improvement in blood glucose control may be associated with acute painful neuropathy, which is usually reversible. Intensification of insulin therapy with abrupt improvement in glycaemic control may be associated with temporary worsening of diabetic retinopathy, while long-term improved glycaemic control decreases the risk of progression of diabetic retinopathy.

Tabulated list of adverse reactions

Adverse reactions listed below are based on clinical trial data and classified according to MedDRA frequency and System Organ Class. Frequency categories are defined according to the following convention: Very common ($\geq 1/10$); common ($\geq 1/100$ to $< 1/10$); uncommon ($\geq 1/1,000$ to $< 1/100$); rare ($\geq 1/10,000$ to $< 1/1,000$); very rare ($< 1/10,000$); not known (cannot be estimated from the available data).

Immune system disorders	Uncommon – Urticaria, rash, eruptions
	Very rare – Anaphylactic reactions*
Metabolism and nutrition disorders	Very common – Hypoglycaemia*
Nervous system disorders	Rare – Peripheral neuropathy (painful neuropathy)

Eye disorders	Uncommon – Refraction disorders
	Uncommon – Diabetic retinopathy
Skin and subcutaneous tissue disorders	Uncommon – Lipodystrophy*
	Not known – Cutaneous amyloidosis*†
General disorders and administration site conditions	Uncommon – Injection site reactions
	Uncommon – Oedema

* see section 4.8, Description of selected adverse reactions.

† ADR from postmarketing sources.

Description of selected adverse reactions

Anaphylactic reactions:

The occurrence of generalised hypersensitivity reactions (including generalised skin rash, itching, sweating, gastrointestinal upset, angioneurotic oedema, difficulties in breathing, palpitation and reduction in blood pressure) is very rare but can potentially be life threatening.

Hypoglycaemia:

The most frequently reported adverse reaction is hypoglycaemia. It may occur if the insulin dose is too high in relation to the insulin requirement. Severe hypoglycaemia may lead to unconsciousness and/or convulsions and may result in temporary or permanent impairment of brain function or even death.

The symptoms of hypoglycaemia usually occur suddenly. They may include cold sweats, cool pale skin, fatigue, nervousness or tremor, anxiousness, unusual tiredness or weakness, confusion, difficulty in concentration, drowsiness, excessive hunger, vision changes, headache, nausea and palpitation.

In clinical trials, the frequency of hypoglycaemia varied with patient population, dose regimens and level of glycaemic control. During clinical trials the overall rates of hypoglycaemia did not differ between patients treated with insulin aspart compared to human insulin.

Skin and subcutaneous tissue disorders:

Lipodystrophy (including lipohypertrophy, lipoatrophy) and cutaneous amyloidosis may occur at the injection site and delay local insulin absorption. Continuous rotation of the injection site within the given injection area may help to reduce or prevent these reactions (see section 4.4).

Paediatric population

Based on post-marketing sources and clinical trials, the frequency, type and severity of adverse reactions observed in the paediatric population do not indicate any differences to the broader experience in the general population.

Other special populations

Based on post-marketing sources and clinical trials, the frequency, type and severity of adverse reactions observed in the elderly patients and in patients with renal or hepatic impairment do not indicate any differences to the broader experience in the general population.

Reporting of suspected adverse reactions

Reporting suspected adverse reactions after authorisation of the medicinal product is important. It allows continued monitoring of the benefit/risk balance of the medicinal product. Healthcare professionals are asked to report any suspected adverse reactions via [the national reporting system listed in Appendix V](#).

4.9 Overdose

A specific overdose for insulin cannot be defined, however, hypoglycaemia may develop over sequential stages if too high doses relative to the patient's requirement are administered:

- Mild hypoglycaemic episodes can be treated by oral administration of glucose or sugary products. It is therefore recommended that the diabetic patient always carries sugar-containing products.
- Severe hypoglycaemic episodes, where the patient has become unconscious, can be treated with glucagon (0.5 to 1 mg) given intramuscularly or subcutaneously by a trained person, or with glucose given intravenously by physicians or other healthcare staff. Glucose must be given intravenously, if the patient does not respond to glucagon within 10 to 15 minutes. Upon regaining consciousness, administration of oral carbohydrates is recommended for the patient in order to prevent a relapse.

5. PHARMACOLOGICAL PROPERTIES

5.1 Pharmacodynamic properties

Pharmacotherapeutic group: Drugs used in diabetes. Insulins and analogues for injection, fast-acting.
ATC code: A10AB05.

Mechanism of action and pharmacodynamic effects

The blood glucose lowering effect of insulin aspart is due to the facilitated uptake of glucose following binding of insulin to receptors on muscle and fat cells and to the simultaneous inhibition of glucose output from the liver.

NovoRapid produces a more rapid onset of action compared to soluble human insulin, together with a lower glucose concentration, as assessed within the first four hours after a meal. NovoRapid has a shorter duration of action compared to soluble human insulin after subcutaneous injection.

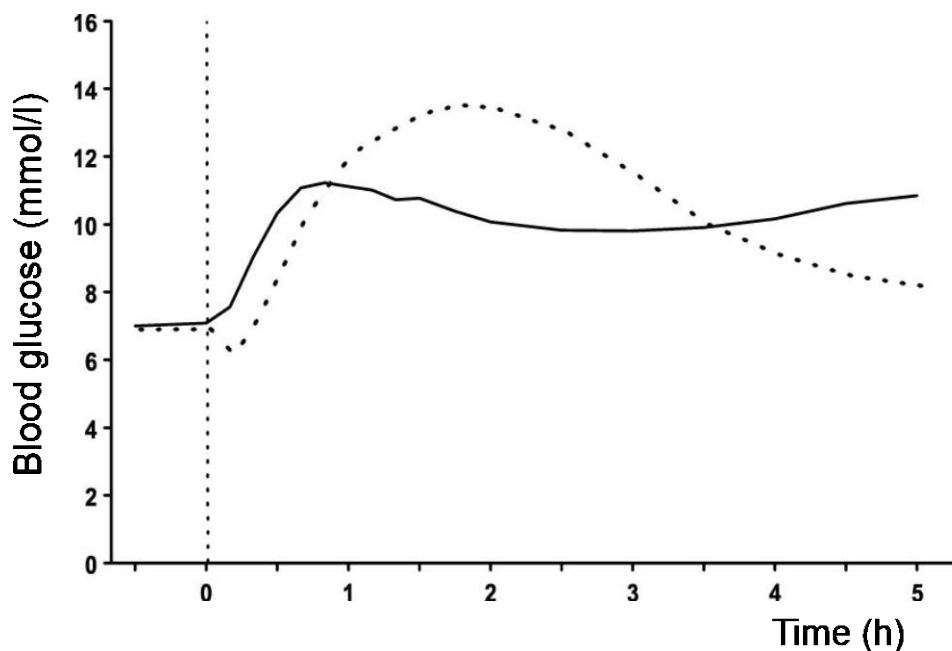

Fig. I. Blood glucose concentrations following a single pre-meal dose of NovoRapid injected immediately before a meal (solid curve) or soluble human insulin administered 30 minutes before a meal (hatched curve) in patients with type 1 diabetes mellitus.

When NovoRapid is injected subcutaneously, the onset of action will occur within 10 to 20 minutes of injection. The maximum effect is exerted between 1 and 3 hours after injection. The duration of action is 3 to 5 hours.

Clinical efficacy

Clinical trials in patients with type 1 diabetes have demonstrated a lower postprandial blood glucose with NovoRapid compared to soluble human insulin (Fig. I). In two long-term open label trials in patients with type 1 diabetes comprising 1070 and 884 patients, respectively, NovoRapid reduced glycated haemoglobin by 0.12 [95% C.I. 0.03; 0.22] percentage points and by 0.15 [95% C.I. 0.05; 0.26] percentage points compared to human insulin; a difference of limited clinical significance.

Clinical trials in patients with type 1 diabetes have demonstrated a reduced risk of nocturnal hypoglycaemia with insulin aspart compared with soluble human insulin. The risk of daytime hypoglycaemia was not significantly increased.

Insulin aspart is equipotent to soluble human insulin on a molar basis.

Special populations

Elderly (≥ 65 years old)

A randomised, double-blind cross-over PK/PD trial comparing insulin aspart with soluble human insulin was performed in elderly patients with type 2 diabetes (19 patients aged 65–83 years, mean age 70 years). The relative differences in the pharmacodynamic properties (GIR_{max} , $AUC_{GIR, 0-120 \text{ min}}$) between insulin aspart and soluble human insulin in the elderly were similar to those seen in healthy subjects and in younger patients with diabetes.

Paediatric population

A clinical trial comparing preprandial soluble human insulin with postprandial insulin aspart was performed in small children (20 patients aged 2 to less than 6 years, studied for 12 weeks, among those four were younger than 4 years old) and a single dose PK/PD trial was performed in children (6–12 years) and adolescents (13–17 years). The pharmacodynamic profile of insulin aspart in children was similar to that seen in adults.

The efficacy and safety of NovoRapid given as bolus insulin in combination with either insulin detemir or insulin degludec as basal insulin has been studied for up to 12 months, in two randomised controlled clinical trials in adolescents and children aged 1 to less than 18 years ($n=712$). The trials included 167 children aged 1–5 years, 260 aged 6–11 and 285 aged 12–17. The observed improvements in HbA1c and the safety profiles were comparable between all age groups.

Pregnancy

A clinical trial comparing safety and efficacy of insulin aspart vs. human insulin in the treatment of pregnant women with type 1 diabetes (322 exposed pregnancies (insulin aspart: 157; human insulin: 165)) did not indicate any adverse effect of insulin aspart on pregnancy or on the health of the foetus/newborn.

In addition the data from a clinical trial including 27 women with gestational diabetes randomised to treatment with insulin aspart vs. human insulin (insulin aspart: 14; human insulin: 13) showed similar safety profiles between treatments.

5.2 Pharmacokinetic properties

Absorption, distribution and elimination

In NovoRapid substitution of amino acid proline with aspartic acid at position B28 reduces the tendency to form hexamers as observed with soluble human insulin. NovoRapid is therefore more rapidly absorbed from the subcutaneous layer compared to soluble human insulin.

The time to maximum concentration is, on average, half of that for soluble human insulin. A mean maximum plasma concentration of 492 ± 256 pmol/l was reached 40 (interquartile range: 30–40) minutes after a subcutaneous dose of 0.15 unit/kg bodyweight in type 1 diabetic patients. The insulin concentrations returned to baseline about 4 to 6 hours after dose. The absorption rate was somewhat slower in type 2 diabetic patients, resulting in a lower C_{\max} (352 ± 240 pmol/l) and later t_{\max} (60 (interquartile range: 50–90) minutes). The intra-individual variability in time to maximum concentration is significantly less for NovoRapid than for soluble human insulin, whereas the intra-individual variability in C_{\max} for NovoRapid is larger.

Special populations

Elderly (≥ 65 years old)

The relative differences in pharmacokinetic properties between insulin aspart and soluble human insulin in elderly patients (65–83 years, mean age 70 years) with type 2 diabetes were similar to those observed in healthy subjects and in younger patients with diabetes. A decreased absorption rate was observed in elderly patients, resulting in a later t_{\max} (82 (interquartile range: 60–120) minutes), whereas C_{\max} was similar to that observed in younger patients with type 2 diabetes and slightly lower than in patients with type 1 diabetes.

Hepatic impairment

A single dose pharmacokinetic study of insulin aspart was performed in 24 subjects with hepatic function ranging from normal to severely impaired. In patients with hepatic impairment, absorption rate was decreased and more variable, resulting in delayed t_{\max} from about 50 min in subjects with normal hepatic function to about 85 min in patients with moderate and severe hepatic impairment. AUC, C_{\max} and CL/F were similar in patients with reduced hepatic function compared with subjects with normal hepatic function.

Renal impairment

A single dose pharmacokinetic study of insulin aspart in 18 subjects with renal function ranging from normal to severely impaired was performed. No apparent effect of creatinine clearance values on AUC, C_{\max} , CL/F and t_{\max} of insulin aspart was found. Data were limited in patients with moderate and severe renal impairment. Patients with renal failure necessitating dialysis treatment were not investigated.

Paediatric population

The pharmacokinetic and pharmacodynamic properties of NovoRapid were investigated in children (6–12 years) and adolescents (13–17 years) with type 1 diabetes. Insulin aspart was rapidly absorbed in both age groups, with similar t_{\max} as in adults. However, C_{\max} differed between the age groups, stressing the importance of the individual titration of NovoRapid.

5.3 Preclinical safety data

Non-clinical data reveal no special hazard for humans based on conventional studies of safety pharmacology, repeated dose toxicity, genotoxicity and toxicity to reproduction and development.

In *in vitro* tests, including binding to insulin and IGF-1 receptor sites and effects on cell growth, insulin aspart behaved in a manner that closely resembled human insulin. Studies also demonstrate that the dissociation of binding to the insulin receptor of insulin aspart is equivalent to human insulin.

6. PHARMACEUTICAL PARTICULARS

6.1 List of excipients

Glycerol
Phenol
Metacresol
Zinc chloride
Disodium phosphate dihydrate
Sodium chloride
Hydrochloric acid (for pH adjustment)
Sodium hydroxide (for pH adjustment)
Water for injections

6.2 Incompatibilities

Substances added to NovoRapid may cause degradation of insulin aspart.
This medicinal product must not be diluted or mixed with other medicinal products except for mixing with NPH (Neutral Protamine Hagedorn) insulin in a syringe for subcutaneous use, or with infusion fluids as described in section 4.2.

6.3 Shelf life

Before opening: 30 months.

NovoRapid vial/NovoRapid Penfill/NovoRapid FlexPen/NovoRapid InnoLet/NovoRapid FlexTouch
During use or when carried as a spare: The product must be stored for a maximum of 4 weeks. Store below 30°C.

NovoRapid PumpCart

During use or when carried as a spare: NovoRapid PumpCart carried as a spare can be kept for up to 2 weeks below 30°C. Thereafter it can be used for up to 7 days below 37°C in an insulin infusion pump system designed to be used with this cartridge, such as the Accu-Chek Insight and YpsoPump insulin pumps.

6.4 Special precautions for storage

For storage conditions of the medicinal product, see section 6.3.

Before opening: Store in a refrigerator (2°C – 8°C). Do not freeze.

NovoRapid vial/NovoRapid Penfill

During use or when carried as a spare: Store below 30°C. Do not refrigerate. Do not freeze.
Keep the vial/cartridge in the outer carton in order to protect from light.

NovoRapid FlexPen/NovoRapid FlexTouch

During use or when carried as a spare: Store below 30°C. Can be stored in a refrigerator (2°C – 8°C).
Do not freeze.
Keep the pen cap on the pen in order to protect from light.

NovoRapid InnoLet

During use or when carried as a spare: Store below 30°C. Do not refrigerate. Do not freeze.
Keep the pen cap on the pen in order to protect from light.

NovoRapid PumpCart

During use or when carried as a spare: Store below 37°C (in use) or store below 30°C (carried as a spare). Do not refrigerate. Do not freeze.

Keep the cartridge in the outer carton in order to protect from light.

6.5 Nature and contents of container

NovoRapid vial

10 ml solution in vial (type 1 glass) closed with a disc (bromobutyl/polyisoprene rubber) and a protective tamper-proof plastic cap.

Pack sizes of 1 or 5 vials of 10 ml or a multipack containing 5 packs of 1 x 10 ml vial. Not all pack sizes may be marketed.

NovoRapid Penfill

3 ml solution in cartridge (type 1 glass) with a plunger (bromobutyl) and a rubber closure (bromobutyl/polyisoprene).

Pack sizes of 5 and 10 cartridges. Not all pack sizes may be marketed.

NovoRapid FlexPen

3 ml solution in cartridge (type 1 glass) with a plunger (bromobutyl) and a rubber closure (bromobutyl/polyisoprene) contained in a pre-filled multidose disposable pen made of polypropylene.

Pack sizes of 1 (with or without needles), 5 (without needles) and 10 (without needles) pre-filled pens. Not all pack sizes may be marketed.

NovoRapid InnoLet

3 ml solution in cartridge (type 1 glass) with a plunger (bromobutyl) and a rubber closure (bromobutyl/polyisoprene) contained in a pre-filled multidose disposable pen made of polypropylene.

Pack sizes of 1, 5 and 10 pre-filled pens. Not all pack sizes may be marketed.

NovoRapid FlexTouch

3 ml solution in cartridge (type 1 glass) with a plunger (bromobutyl) and a rubber closure (bromobutyl/polyisoprene) contained in a pre-filled multidose disposable pen made of polypropylene.

Pack sizes of 1 (with or without needles), 5 (without needles) or a multipack with 2 x 5 (without needles) pre-filled pens of 3 ml. Not all pack sizes may be marketed.

NovoRapid PumpCart

1.6 ml solution in cartridge (type 1 glass) with a plunger (bromobutyl) and a rubber closure (bromobutyl/polyisoprene).

Pack size of 5 cartridges and a multipack containing 25 (5 packs of 5) cartridges. Not all pack sizes may be marketed.

6.6 Special precautions for disposal and other handling

Do not use this medicinal product if you notice that the solution is not clear, colourless and aqueous.

NovoRapid which has been frozen must not be used.

The patient should be advised to discard the needle after each injection.

Any unused medicinal product or waste material should be disposed of in accordance with local requirements.

Needles, syringes, cartridges, pre-filled pens and infusion sets must not be shared.

The cartridge must not be refilled.

NovoRapid vial

NovoRapid may be used in an infusion pump system (CSII) as described in section 4.2. Tubings in which the inner surface materials are made of polyethylene or polyolefin have been evaluated and found compatible with pump use.

NovoRapid PumpCart

NovoRapid PumpCart is a pre-filled cartridge ready for use directly in the pump. Please refer to the package leaflet where detailed instructions for use are provided.

To ensure correct dosing, NovoRapid PumpCart must not be used in an insulin pen.

NovoRapid PumpCart is only for use with an insulin infusion pump system designed to be used with this cartridge, such as the Accu-Chek Insight and YpsoPump insulin pumps, as described in section 4.2. Tubings in which the inner surface materials are made of polyethylene or polyolefin have been evaluated and found compatible with pump use.

7. MARKETING AUTHORISATION HOLDER

Novo Nordisk A/S, Novo Allé, DK-2880 Bagsværd, Denmark

8. MARKETING AUTHORISATION NUMBERS

NovoRapid vial

EU/1/99/119/001

EU/1/99/119/008

EU/1/99/119/015

NovoRapid Penfill

EU/1/99/119/003

EU/1/99/119/006

NovoRapid FlexPen

EU/1/99/119/009

EU/1/99/119/010

EU/1/99/119/011

EU/1/99/119/017

EU/1/99/119/018

NovoRapid InnoLet

EU/1/99/119/012

EU/1/99/119/013

EU/1/99/119/014

NovoRapid FlexTouch

EU/1/99/119/019

EU/1/99/119/020

EU/1/99/119/021

EU/1/99/119/022

EU/1/99/119/023

NovoRapid PumpCart
EU/1/99/119/024
EU/1/99/119/025

9. DATE OF FIRST AUTHORISATION/RENEWAL OF THE AUTHORISATION

Date of first authorisation: 7 September 1999

Date of last renewal: 30 April 2009

10. DATE OF REVISION OF THE TEXT

Detailed information on this medicinal product is available on the website of the European Medicines Agency <http://www.ema.europa.eu>.

ANNEX II

- A. MANUFACTURERS OF THE BIOLOGICAL ACTIVE SUBSTANCE AND MANUFACTURERS RESPONSIBLE FOR BATCH RELEASE**
- B. CONDITIONS OR RESTRICTIONS REGARDING SUPPLY AND USE**
- C. OTHER CONDITIONS AND REQUIREMENTS OF THE MARKETING AUTHORISATION**
- D. CONDITIONS OR RESTRICTIONS WITH REGARD TO THE SAFE AND EFFECTIVE USE OF THE MEDICINAL PRODUCT**

**A. MANUFACTURERS OF THE BIOLOGICAL ACTIVE SUBSTANCE AND
MANUFACTURERS RESPONSIBLE FOR BATCH RELEASE**

Name and address of the manufacturers of the biological active substance

Novo Nordisk A/S
Hallas Allé
DK-4400 Kalundborg
Denmark

Novo Nordisk A/S
Novo Allé
DK-2880 Bagsværd
Denmark

Name and address of the manufacturers responsible for batch release

NovoRapid Vial, InnoLet, FlexTouch and PumpCart:

Novo Nordisk A/S
Novo Allé
DK-2880 Bagsværd
Denmark

NovoRapid Penfill and FlexPen:

Novo Nordisk A/S
Novo Allé
DK-2880 Bagsværd
Denmark

Novo Nordisk Production SAS
45, Avenue d'Orléans
F-28000 Chartres
France

The printed package leaflet of the medicinal product must state the name and address of the manufacturer responsible for the release of the concerned batch.

B. CONDITIONS OR RESTRICTIONS REGARDING SUPPLY AND USE

Medicinal product subject to medical prescription.

**C. OTHER CONDITIONS AND REQUIREMENTS OF THE MARKETING
AUTHORISATION**

• **Periodic safety update reports (PSURs)**

The requirements for submission of PSURs for this medicinal product are set out in the list of Union reference dates (EURD list) provided for under Article 107c(7) of Directive 2001/83/EC and any subsequent updates published on the European medicines web-portal.

D. CONDITIONS OR RESTRICTIONS WITH REGARD TO THE SAFE AND EFFECTIVE USE OF THE MEDICINAL PRODUCT

- **Risk management plan (RMP)**

The marketing authorisation holder (MAH) shall perform the required pharmacovigilance activities and interventions detailed in the agreed RMP presented in Module 1.8.2 of the marketing authorisation and any agreed subsequent updates of the RMP.

An updated RMP should be submitted:

- At the request of the European Medicines Agency;
- Whenever the risk management system is modified, especially as the result of new information being received that may lead to a significant change to the benefit/risk profile or as the result of an important (pharmacovigilance or risk minimisation) milestone being reached.

ANNEX III
LABELLING AND PACKAGE LEAFLET

A. LABELLING

PARTICULARS TO APPEAR ON THE OUTER PACKAGING

OUTER CARTON (VIAL)

1. NAME OF THE MEDICINAL PRODUCT

NovoRapid 100 units/ml solution for injection
insulin aspart

2. STATEMENT OF ACTIVE SUBSTANCE

1 vial contains 10 ml equivalent to 1,000 units. 1 ml solution contains 100 units insulin aspart (equivalent to 3.5 mg),

3. LIST OF EXCIPIENTS

glycerol, phenol, metacresol, zinc chloride, disodium phosphate dihydrate, sodium chloride, hydrochloric acid/sodium hydroxide for pH adjustment and water for injections.

4. PHARMACEUTICAL FORM AND CONTENTS

Solution for injection

1 vial of 10 ml
5 vials of 10 ml

5. METHOD AND ROUTES OF ADMINISTRATION

Read the package leaflet before use
Subcutaneous or intravenous use

6. SPECIAL WARNING THAT THE MEDICINAL PRODUCT MUST BE STORED OUT OF THE SIGHT AND REACH OF CHILDREN

Keep out of the sight and reach of children

7. OTHER SPECIAL WARNING, IF NECESSARY

Use solution only if clear and colourless

8. EXPIRY DATE

EXP/
During use: Use within 4 weeks

9. SPECIAL STORAGE CONDITIONS

Before opening: Store in a refrigerator (2°C to 8°C)
During use: Do not refrigerate. Store below 30°C
Do not freeze
Keep the vial in the outer carton in order to protect from light

10. SPECIAL PRECAUTIONS FOR DISPOSAL OF UNUSED MEDICINAL PRODUCTS OR WASTE MATERIALS DERIVED FROM SUCH MEDICINAL PRODUCTS, IF APPROPRIATE

Discard the needle after each injection

11. NAME AND ADDRESS OF THE MARKETING AUTHORISATION HOLDER

Novo Nordisk A/S
Novo Allé
DK-2880 Bagsværd
Denmark

12. MARKETING AUTHORISATION NUMBERS

EU/1/99/119/001 1 vial of 10 ml
EU/1/99/119/008 5 vials of 10 ml

13. BATCH NUMBER

Batch:

14. GENERAL CLASSIFICATION FOR SUPPLY**15. INSTRUCTIONS ON USE****16. INFORMATION IN BRAILLE**

NovoRapid

17. UNIQUE IDENTIFIER – 2D BARCODE

2D barcode carrying the unique identifier included

18. UNIQUE IDENTIFIER – HUMAN READABLE DATA

PC
SN
NN

MINIMUM PARTICULARS TO APPEAR ON SMALL IMMEDIATE PACKAGING UNITS

LABEL (VIAL)

1. NAME OF THE MEDICINAL PRODUCT AND ROUTES OF ADMINISTRATION

NovoRapid 100 units/ml solution for injection
insulin aspart
SC, IV use

2. METHOD OF ADMINISTRATION

3. EXPIRY DATE

EXP

4. BATCH NUMBER

Batch

5. CONTENTS BY WEIGHT, BY VOLUME OR BY UNIT

10 ml
1 vial of 10 ml contains 1,000 units

6. OTHER

Novo Nordisk A/S

PARTICULARS TO APPEAR ON THE OUTER PACKAGING

OUTER WRAPPER LABEL ON MULTIPACK (VIAL – with blue box)

1. NAME OF THE MEDICINAL PRODUCT

NovoRapid 100 units/ml solution for injection
insulin aspart

2. STATEMENT OF ACTIVE SUBSTANCE

1 vial contains 10 ml equivalent to 1,000 units. 1 ml solution contains 100 units insulin aspart (equivalent to 3.5 mg),

3. LIST OF EXCIPIENTS

glycerol, phenol, metacresol, zinc chloride, disodium phosphate dihydrate, sodium chloride, hydrochloric acid/sodium hydroxide for pH adjustment and water for injections.

4. PHARMACEUTICAL FORM AND CONTENTS

Solution for injection

Multipack: 5 packs of 1 x 10 ml vial

5. METHOD AND ROUTES OF ADMINISTRATION

Read the package leaflet before use
Subcutaneous or intravenous use

6. SPECIAL WARNING THAT THE MEDICINAL PRODUCT MUST BE STORED OUT OF THE SIGHT AND REACH OF CHILDREN

Keep out of the sight and reach of children

7. OTHER SPECIAL WARNING, IF NECESSARY

Use solution only if clear and colourless

8. EXPIRY DATE

EXP/
During use: Use within 4 weeks

9. SPECIAL STORAGE CONDITIONS

Before opening: Store in a refrigerator (2°C to 8°C)
During use: Do not refrigerate. Store below 30°C
Do not freeze
Keep the vial in the outer carton in order to protect from light

10. SPECIAL PRECAUTIONS FOR DISPOSAL OF UNUSED MEDICINAL PRODUCTS OR WASTE MATERIALS DERIVED FROM SUCH MEDICINAL PRODUCTS, IF APPROPRIATE

Discard the needle after each injection

11. NAME AND ADDRESS OF THE MARKETING AUTHORISATION HOLDER

Novo Nordisk A/S
Novo Allé
DK-2880 Bagsværd
Denmark

12. MARKETING AUTHORISATION NUMBER

EU/1/99/119/015 5 packs of 1 x 10 ml vial

13. BATCH NUMBER

Batch:

14. GENERAL CLASSIFICATION FOR SUPPLY**15. INSTRUCTIONS ON USE****16. INFORMATION IN BRAILLE**

NovoRapid

17. UNIQUE IDENTIFIER – 2D BARCODE

2D barcode carrying the unique identifier included

18. UNIQUE IDENTIFIER – HUMAN READABLE DATA

PC
SN
NN

PARTICULARS TO APPEAR ON THE OUTER PACKAGING

INNER CARTON FOR MULTIPACK (VIAL – without blue box)

1. NAME OF THE MEDICINAL PRODUCT

NovoRapid 100 units/ml solution for injection
insulin aspart

2. STATEMENT OF ACTIVE SUBSTANCE

1 vial contains 10 ml equivalent to 1,000 units. 1 ml solution contains 100 units insulin aspart (equivalent to 3.5 mg),

3. LIST OF EXCIPIENTS

glycerol, phenol, metacresol, zinc chloride, disodium phosphate dihydrate, sodium chloride, hydrochloric acid/sodium hydroxide for pH adjustment and water for injections.

4. PHARMACEUTICAL FORM AND CONTENTS

Solution for injection

1 vial of 10 ml. Component of a multipack, cannot be sold separately.

5. METHOD AND ROUTES OF ADMINISTRATION

Read the package leaflet before use
Subcutaneous or intravenous use

6. SPECIAL WARNING THAT THE MEDICINAL PRODUCT MUST BE STORED OUT OF THE SIGHT AND REACH OF CHILDREN

Keep out of the sight and reach of children

7. OTHER SPECIAL WARNING, IF NECESSARY

Use solution only if clear and colourless

8. EXPIRY DATE

EXP/
During use: Use within 4 weeks

9. SPECIAL STORAGE CONDITIONS

Before opening: Store in a refrigerator (2°C to 8°C)
During use: Do not refrigerate. Store below 30°C
Do not freeze
Keep the vial in the outer carton in order to protect from light

10. SPECIAL PRECAUTIONS FOR DISPOSAL OF UNUSED MEDICINAL PRODUCTS OR WASTE MATERIALS DERIVED FROM SUCH MEDICINAL PRODUCTS, IF APPROPRIATE

Discard the needle after each injection

11. NAME AND ADDRESS OF THE MARKETING AUTHORISATION HOLDER

Novo Nordisk A/S
Novo Allé
DK-2880 Bagsværd
Denmark

12. MARKETING AUTHORISATION NUMBER

EU/1/99/119/015 5 packs of 1 x 10 ml vial

13. BATCH NUMBER

Batch:

14. GENERAL CLASSIFICATION FOR SUPPLY**15. INSTRUCTIONS ON USE****16. INFORMATION IN BRAILLE**

NovoRapid

17. UNIQUE IDENTIFIER – 2D BARCODE**18. UNIQUE IDENTIFIER – HUMAN READABLE DATA**

PARTICULARS TO APPEAR ON THE OUTER PACKAGING

OUTER CARTON (CARTRIDGE. Penfill)

1. NAME OF THE MEDICINAL PRODUCT

NovoRapid Penfill 100 units/ml solution for injection in cartridge
insulin aspart

2. STATEMENT OF ACTIVE SUBSTANCE

1 cartridge contains 3 ml equivalent to 300 units. 1 ml solution contains 100 units insulin aspart
(equivalent to 3.5 mg),

3. LIST OF EXCIPIENTS

glycerol, phenol, metacresol, zinc chloride, disodium phosphate dihydrate, sodium chloride,
hydrochloric acid/sodium hydroxide for pH adjustment and water for injections.

4. PHARMACEUTICAL FORM AND CONTENTS

Solution for injection

5 x 3 ml cartridges

10 x 3 ml cartridges

5. METHOD AND ROUTES OF ADMINISTRATION

Read the package leaflet before use
Subcutaneous use

6. SPECIAL WARNING THAT THE MEDICINAL PRODUCT MUST BE STORED OUT OF THE SIGHT AND REACH OF CHILDREN

Keep out of the sight and reach of children

7. OTHER SPECIAL WARNINGS, IF NECESSARY

Use solution only if clear and colourless
For use by one person only

8. EXPIRY DATE

EXP/

During use: Use within 4 weeks

9. SPECIAL STORAGE CONDITIONS

Before opening: Store in a refrigerator (2°C to 8°C)
During use: Do not refrigerate. Store below 30°C
Do not freeze
Keep the cartridge in the outer carton in order to protect from light

10. SPECIAL PRECAUTIONS FOR DISPOSAL OF UNUSED MEDICINAL PRODUCTS OR WASTE MATERIALS DERIVED FROM SUCH MEDICINAL PRODUCTS, IF APPROPRIATE

Discard the needle after each injection

11. NAME AND ADDRESS OF THE MARKETING AUTHORISATION HOLDER

Novo Nordisk A/S
Novo Allé
DK-2880 Bagsværd
Denmark

12. MARKETING AUTHORISATION NUMBERS

EU/1/99/119/003 5 cartridges of 3 ml
EU/1/99/119/006 10 cartridges of 3 ml

13. BATCH NUMBER

Batch:

14. GENERAL CLASSIFICATION FOR SUPPLY**15. INSTRUCTIONS ON USE****16. INFORMATION IN BRAILLE**

NovoRapid Penfill

17. UNIQUE IDENTIFIER – 2D BARCODE

2D barcode carrying the unique identifier included

18. UNIQUE IDENTIFIER – HUMAN READABLE DATA

PC
SN
NN

MINIMUM PARTICULARS TO APPEAR ON SMALL IMMEDIATE PACKAGING UNITS

LABEL (CARTRIDGE. Penfill)

1. NAME OF THE MEDICINAL PRODUCT AND ROUTES OF ADMINISTRATION

NovoRapid Penfill 100 units/ml solution for injection
insulin aspart
SC use

2. METHOD OF ADMINISTRATION

Penfill

3. EXPIRY DATE

EXP

4. BATCH NUMBER

Batch

5. CONTENTS BY WEIGHT, BY VOLUME OR BY UNIT

3 ml

6. OTHER

Novo Nordisk A/S

PARTICULARS TO APPEAR ON THE OUTER PACKAGING

OUTER CARTON (PRE-FILLED PEN. FlexPen)

1. NAME OF THE MEDICINAL PRODUCT

NovoRapid FlexPen 100 units/ml solution for injection in pre-filled pen
insulin aspart

2. STATEMENT OF ACTIVE SUBSTANCE

1 pre-filled pen contains 3 ml equivalent to 300 units. 1 ml solution contains 100 units insulin aspart
(equivalent to 3.5 mg),

3. LIST OF EXCIPIENTS

glycerol, phenol, metacresol, zinc chloride, disodium phosphate dihydrate, sodium chloride,
hydrochloric acid/sodium hydroxide for pH adjustment and water for injections.

4. PHARMACEUTICAL FORM AND CONTENTS

Solution for injection

1 x 3 ml pre-filled pen
5 x 3 ml pre-filled pens
10 x 3 ml pre-filled pens
1 x 3 ml pre-filled pen + 7 NovoFine needles
1 x 3 ml pre-filled pen + 7 NovoTwist needles

5. METHOD AND ROUTES OF ADMINISTRATION

Needles are not included
Read the package leaflet before use
Subcutaneous use

6. SPECIAL WARNING THAT THE MEDICINAL PRODUCT MUST BE STORED OUT OF THE SIGHT AND REACH OF CHILDREN

Keep out of the sight and reach of children

7. OTHER SPECIAL WARNINGS, IF NECESSARY

Use solution only if clear and colourless
For use by one person only
Designed to be used with NovoFine or NovoTwist disposable needles up to a length of 8 mm

8. EXPIRY DATE

EXP/

During use: Use within 4 weeks

9. SPECIAL STORAGE CONDITIONS

Before opening: Store in a refrigerator (2°C to 8°C)

During use: Store below 30°C. Can be stored in a refrigerator (2°C to 8°C)

Do not freeze

Keep the pen cap on in order to protect from light

10. SPECIAL PRECAUTIONS FOR DISPOSAL OF UNUSED MEDICINAL PRODUCTS OR WASTE MATERIALS DERIVED FROM SUCH MEDICINAL PRODUCTS, IF APPROPRIATE

Discard the needle after each injection

11. NAME AND ADDRESS OF THE MARKETING AUTHORISATION HOLDER

Novo Nordisk A/S
Novo Allé
DK-2880 Bagsværd
Denmark

12. MARKETING AUTHORISATION NUMBERS

EU/1/99/119/011 1 pen of 3 ml
EU/1/99/119/009 5 pens of 3 ml
EU/1/99/119/010 10 pens of 3 ml
EU/1/99/119/017 1 pen of 3 ml and 7 NovoFine needles
EU/1/99/119/018 1 pen of 3 ml and 7 NovoTwist needles

13. BATCH NUMBER

Batch:

14. GENERAL CLASSIFICATION FOR SUPPLY**15. INSTRUCTIONS ON USE****16. INFORMATION IN BRAILLE**

NovoRapid FlexPen

17. UNIQUE IDENTIFIER – 2D BARCODE

2D barcode carrying the unique identifier included

18. UNIQUE IDENTIFIER – HUMAN READABLE DATA

PC
SN
NN

MINIMUM PARTICULARS TO APPEAR ON SMALL IMMEDIATE PACKAGING UNITS

PEN LABEL (PRE-FILLED PEN. FlexPen)

1. NAME OF THE MEDICINAL PRODUCT AND ROUTES OF ADMINISTRATION

NovoRapid FlexPen 100 units/ml solution for injection
insulin aspart
SC use

2. METHOD OF ADMINISTRATION

FlexPen

3. EXPIRY DATE

EXP

4. BATCH NUMBER

Batch

5. CONTENTS BY WEIGHT, BY VOLUME OR BY UNIT

3 ml

6. OTHER

Novo Nordisk A/S

PARTICULARS TO APPEAR ON THE OUTER PACKAGING

OUTER CARTON (PRE-FILLED PEN. InnoLet)

1. NAME OF THE MEDICINAL PRODUCT

NovoRapid InnoLet 100 units/ml solution for injection in pre-filled pen
insulin aspart

2. STATEMENT OF ACTIVE SUBSTANCE

1 pre-filled pen contains 3 ml equivalent to 300 units. 1 ml solution contains 100 units insulin aspart
(equivalent to 3.5 mg),

3. LIST OF EXCIPIENTS

glycerol, phenol, metacresol, zinc chloride, disodium phosphate dihydrate, sodium chloride,
hydrochloric acid/sodium hydroxide for pH adjustment and water for injections.

4. PHARMACEUTICAL FORM AND CONTENTS

Solution for injection

1 x 3 ml pre-filled pen
5 x 3 ml pre-filled pens
10 x 3 ml pre-filled pens

5. METHOD AND ROUTES OF ADMINISTRATION

Needles are not included
Read the package leaflet before use
Subcutaneous use

6. SPECIAL WARNING THAT THE MEDICINAL PRODUCT MUST BE STORED OUT OF THE SIGHT AND REACH OF CHILDREN

Keep out of the sight and reach of children

7. OTHER SPECIAL WARNINGS, IF NECESSARY

Use solution only if clear and colourless
For use by one person only
Designed to be used with NovoFine or NovoTwist disposable needles up to a length of 8 mm

8. EXPIRY DATE

EXP/

During use: Use within 4 weeks

9. SPECIAL STORAGE CONDITIONS

Before opening: Store in a refrigerator (2°C to 8°C)

During use: Do not refrigerate. Store below 30°C

Do not freeze

Keep the pen cap on in order to protect from light

10. SPECIAL PRECAUTIONS FOR DISPOSAL OF UNUSED MEDICINAL PRODUCTS OR WASTE MATERIALS DERIVED FROM SUCH MEDICINAL PRODUCTS, IF APPROPRIATE

Discard the needle after each injection

11. NAME AND ADDRESS OF THE MARKETING AUTHORISATION HOLDER

Novo Nordisk A/S
Novo Allé
DK-2880 Bagsværd
Denmark

12. MARKETING AUTHORISATION NUMBERS

EU/1/99/119/012 1 pen of 3 ml

EU/1/99/119/013 5 pens of 3 ml

EU/1/99/119/014 10 pens of 3 ml

13. BATCH NUMBER

Batch:

14. GENERAL CLASSIFICATION FOR SUPPLY**15. INSTRUCTIONS ON USE****16. INFORMATION IN BRAILLE**

NovoRapid InnoLet

17. UNIQUE IDENTIFIER – 2D BARCODE

2D barcode carrying the unique identifier included

18. UNIQUE IDENTIFIER – HUMAN READABLE DATA

PC
SN
NN

MINIMUM PARTICULARS TO APPEAR ON SMALL IMMEDIATE PACKAGING UNITS

PEN LABEL (PRE-FILLED PEN. InnoLet)

1. NAME OF THE MEDICINAL PRODUCT AND ROUTES OF ADMINISTRATION

NovoRapid InnoLet 100 units/ml solution for injection
insulin aspart
SC use

2. METHOD OF ADMINISTRATION

InnoLet

3. EXPIRY DATE

EXP

4. BATCH NUMBER

Batch

5. CONTENTS BY WEIGHT, BY VOLUME OR BY UNIT

3 ml

6. OTHER

Novo Nordisk A/S

PARTICULARS TO APPEAR ON THE OUTER PACKAGING

OUTER CARTON (PRE-FILLED PEN. FlexTouch)

1. NAME OF THE MEDICINAL PRODUCT

NovoRapid FlexTouch 100 units/ml solution for injection in pre-filled pen
insulin aspart

2. STATEMENT OF ACTIVE SUBSTANCE

1 pre-filled pen contains 3 ml equivalent to 300 units. 1 ml solution contains 100 units insulin aspart
(equivalent to 3.5 mg),

3. LIST OF EXCIPIENTS

glycerol, phenol, metacresol, zinc chloride, disodium phosphate dihydrate, sodium chloride,
hydrochloric acid/sodium hydroxide for pH adjustment and water for injections.

4. PHARMACEUTICAL FORM AND CONTENTS

Solution for injection

1 x 3 ml pre-filled pen

5 x 3 ml pre-filled pens

1 x 3 ml pre-filled pen + 7 NovoFine needles

1 x 3 ml pre-filled pen + 7 NovoTwist needles

5. METHOD AND ROUTES OF ADMINISTRATION

Needles are not included

Read the package leaflet before use

Subcutaneous use

6. SPECIAL WARNING THAT THE MEDICINAL PRODUCT MUST BE STORED OUT OF THE SIGHT AND REACH OF CHILDREN

Keep out of the sight and reach of children

7. OTHER SPECIAL WARNINGS, IF NECESSARY

Use solution only if clear and colourless

For use by one person only

Designed to be used with NovoFine or NovoTwist disposable needles up to a length of 8 mm

8. EXPIRY DATE

EXP/

During use: Use within 4 weeks

9. SPECIAL STORAGE CONDITIONS

Before opening: Store in a refrigerator (2°C to 8°C)

During use: Store below 30°C. Can be stored in a refrigerator (2°C to 8°C)

Do not freeze

Keep the pen cap on in order to protect from light

10. SPECIAL PRECAUTIONS FOR DISPOSAL OF UNUSED MEDICINAL PRODUCTS OR WASTE MATERIALS DERIVED FROM SUCH MEDICINAL PRODUCTS, IF APPROPRIATE

Discard the needle after each injection

11. NAME AND ADDRESS OF THE MARKETING AUTHORISATION HOLDER

Novo Nordisk A/S
Novo Allé
DK-2880 Bagsværd
Denmark

12. MARKETING AUTHORISATION NUMBERS

EU/1/99/119/019 1 pen of 3 ml

EU/1/99/119/020 5 pens of 3 ml

EU/1/99/119/022 1 pen of 3 ml and 7 NovoFine needles

EU/1/99/119/023 1 pen of 3 ml and 7 NovoTwist needles

13. BATCH NUMBER

Batch:

14. GENERAL CLASSIFICATION FOR SUPPLY**15. INSTRUCTIONS ON USE****16. INFORMATION IN BRAILLE**

NovoRapid FlexTouch

17. UNIQUE IDENTIFIER – 2D BARCODE

2D barcode carrying the unique identifier included

18. UNIQUE IDENTIFIER – HUMAN READABLE DATA

PC
SN
NN

MINIMUM PARTICULARS TO APPEAR ON SMALL IMMEDIATE PACKAGING UNITS

PEN LABEL (PRE-FILLED PEN. FlexTouch)

1. NAME OF THE MEDICINAL PRODUCT AND ROUTES OF ADMINISTRATION

NovoRapid FlexTouch 100 units/ml solution for injection
insulin aspart
SC use

2. METHOD OF ADMINISTRATION

FlexTouch

3. EXPIRY DATE

EXP

4. BATCH NUMBER

Batch

5. CONTENTS BY WEIGHT, BY VOLUME OR BY UNIT

3 ml

6. OTHER

Novo Nordisk A/S

PARTICULARS TO APPEAR ON THE OUTER PACKAGING

OUTER WRAPPER LABEL ON MULTIPACK (PRE-FILLED PEN. FlexTouch – with blue box)

1. NAME OF THE MEDICINAL PRODUCT

NovoRapid FlexTouch 100 units/ml solution for injection in pre-filled pen
insulin aspart

2. STATEMENT OF ACTIVE SUBSTANCE

1 pre-filled pen contains 3 ml equivalent to 300 units. 1 ml solution contains 100 units insulin aspart (equivalent to 3.5 mg),

3. LIST OF EXCIPIENTS

glycerol, phenol, metacresol, zinc chloride, disodium phosphate dihydrate, sodium chloride, hydrochloric acid/sodium hydroxide for pH adjustment and water for injections.

4. PHARMACEUTICAL FORM AND CONTENTS

Solution for injection

Multipack: 2 x (5 x 3 ml)

5. METHOD AND ROUTES OF ADMINISTRATION

Needles are not included
Read the package leaflet before use
Subcutaneous use

6. SPECIAL WARNING THAT THE MEDICINAL PRODUCT MUST BE STORED OUT OF THE SIGHT AND REACH OF CHILDREN

Keep out of the sight and reach of children

7. OTHER SPECIAL WARNINGS, IF NECESSARY

Use solution only if clear and colourless
For use by one person only
Designed to be used with NovoFine or NovoTwist disposable needles up to a length of 8 mm

8. EXPIRY DATE

EXP/

During use: Use within 4 weeks

9. SPECIAL STORAGE CONDITIONS

Before opening: Store in a refrigerator (2°C to 8°C)

During use: Store below 30°C. Can be stored in a refrigerator (2°C to 8°C)

Do not freeze

Keep the pen cap on in order to protect from light

10. SPECIAL PRECAUTIONS FOR DISPOSAL OF UNUSED MEDICINAL PRODUCTS OR WASTE MATERIALS DERIVED FROM SUCH MEDICINAL PRODUCTS, IF APPROPRIATE

Discard the needle after each injection

11. NAME AND ADDRESS OF THE MARKETING AUTHORISATION HOLDER

Novo Nordisk A/S
Novo Allé
DK-2880 Bagsværd
Denmark

12. MARKETING AUTHORISATION NUMBER

EU/1/99/119/021 2 x (5 x 3 ml)

13. BATCH NUMBER

Batch:

14. GENERAL CLASSIFICATION FOR SUPPLY**15. INSTRUCTIONS ON USE****16. INFORMATION IN BRAILLE**

NovoRapid FlexTouch

17. UNIQUE IDENTIFIER – 2D BARCODE

2D barcode carrying the unique identifier included

18. UNIQUE IDENTIFIER – HUMAN READABLE DATA

PC
SN
NN

PARTICULARS TO APPEAR ON THE OUTER PACKAGING

INNER CARTON FOR MULTIPACK (PRE-FILLED PEN. FlexTouch – without blue box)

1. NAME OF THE MEDICINAL PRODUCT

NovoRapid FlexTouch 100 units/ml solution for injection in pre-filled pen
insulin aspart

2. STATEMENT OF ACTIVE SUBSTANCE

1 pre-filled pen contains 3 ml equivalent to 300 units. 1 ml solution contains 100 units insulin aspart (equivalent to 3.5 mg),

3. LIST OF EXCIPIENTS

glycerol, phenol, metacresol, zinc chloride, disodium phosphate dihydrate, sodium chloride, hydrochloric acid/sodium hydroxide for pH adjustment and water for injections.

4. PHARMACEUTICAL FORM AND CONTENTS

Solution for injection

5 x 3 ml pre-filled pens. Component of a multipack, cannot be sold separately.

5. METHOD AND ROUTES OF ADMINISTRATION

Needles are not included
Read the package leaflet before use
Subcutaneous use

6. SPECIAL WARNING THAT THE MEDICINAL PRODUCT MUST BE STORED OUT OF THE SIGHT AND REACH OF CHILDREN

Keep out of the sight and reach of children

7. OTHER SPECIAL WARNINGS, IF NECESSARY

Use solution only if clear and colourless
For use by one person only
Designed to be used with NovoFine or NovoTwist disposable needles up to a length of 8 mm

8. EXPIRY DATE

EXP/
During use: Use within 4 weeks

9. SPECIAL STORAGE CONDITIONS

Before opening: Store in a refrigerator (2°C to 8°C)

During use: Store below 30°C. Can be stored in a refrigerator (2°C to 8°C)

Do not freeze

Keep the pen cap on in order to protect from light

10. SPECIAL PRECAUTIONS FOR DISPOSAL OF UNUSED MEDICINAL PRODUCTS OR WASTE MATERIALS DERIVED FROM SUCH MEDICINAL PRODUCTS, IF APPROPRIATE

Discard the needle after each injection

11. NAME AND ADDRESS OF THE MARKETING AUTHORISATION HOLDER

Novo Nordisk A/S
Novo Allé
DK-2880 Bagsværd
Denmark

12. MARKETING AUTHORISATION NUMBER

EU/1/99/119/021 2 x 5 pens of 3 ml

13. BATCH NUMBER

Batch:

14. GENERAL CLASSIFICATION FOR SUPPLY**15. INSTRUCTIONS ON USE****16. INFORMATION IN BRAILLE**

NovoRapid FlexTouch

17. UNIQUE IDENTIFIER – 2D BARCODE**18. UNIQUE IDENTIFIER – HUMAN READABLE DATA**

PARTICULARS TO APPEAR ON THE OUTER PACKAGING

OUTER CARTON (CARTRIDGE. PumpCart)

1. NAME OF THE MEDICINAL PRODUCT

NovoRapid PumpCart 100 units/ml solution for injection in cartridge
insulin aspart

2. STATEMENT OF ACTIVE SUBSTANCE

1 cartridge contains 1.6 ml equivalent to 160 units. 1 ml solution contains 100 units insulin aspart
(equivalent to 3.5 mg),

3. LIST OF EXCIPIENTS

glycerol, phenol, metacresol, zinc chloride, disodium phosphate dihydrate, sodium chloride,
hydrochloric acid/sodium hydroxide for pH adjustment and water for injections

4. PHARMACEUTICAL FORM AND CONTENTS

Solution for injection

5 x 1.6 ml cartridges

5. METHOD AND ROUTES OF ADMINISTRATION

Read the package leaflet before use
Subcutaneous use

6. SPECIAL WARNING THAT THE MEDICINAL PRODUCT MUST BE STORED OUT OF THE SIGHT AND REACH OF CHILDREN

Keep out of the sight and reach of children

7. OTHER SPECIAL WARNINGS, IF NECESSARY

Use solution only if clear and colourless
For use by one person only
Only for use in pumps designed for NovoRapid PumpCart

8. EXPIRY DATE

EXP/
During use in pump: Use within 7 days

9. SPECIAL STORAGE CONDITIONS

Before opening: Store in a refrigerator (2°C to 8°C)
Carried as a spare: Can be kept for up to two weeks below 30°C
During use: Do not refrigerate. Store below 37°C
Do not freeze
Keep the cartridge in the outer carton in order to protect from light

10. SPECIAL PRECAUTIONS FOR DISPOSAL OF UNUSED MEDICINAL PRODUCTS OR WASTE MATERIALS DERIVED FROM SUCH MEDICINAL PRODUCTS, IF APPROPRIATE**11. NAME AND ADDRESS OF THE MARKETING AUTHORISATION HOLDER**

Novo Nordisk A/S
Novo Allé
DK-2880 Bagsværd
Denmark

12. MARKETING AUTHORISATION NUMBER

EU/1/99/119/024 5 cartridges of 1.6 ml

13. BATCH NUMBER

Batch:

14. GENERAL CLASSIFICATION FOR SUPPLY**15. INSTRUCTIONS ON USE****16. INFORMATION IN BRAILLE**

NovoRapid PumpCart

17. UNIQUE IDENTIFIER – 2D BARCODE

2D barcode carrying the unique identifier included

18. UNIQUE IDENTIFIER – HUMAN READABLE DATA

PC
SN
NN

MINIMUM PARTICULARS TO APPEAR ON SMALL IMMEDIATE PACKAGING UNITS

LABEL (CARTRIDGE. PumpCart)

1. NAME OF THE MEDICINAL PRODUCT AND ROUTES OF ADMINISTRATION

NovoRapid PumpCart 100 units/ml solution for injection
insulin aspart
SC use

2. METHOD OF ADMINISTRATION

Read the package leaflet before use

3. EXPIRY DATE

EXP

4. BATCH NUMBER

Batch

5. CONTENTS BY WEIGHT, BY VOLUME OR BY UNIT

1.6 ml

6. OTHER

Novo Nordisk A/S

PARTICULARS TO APPEAR ON THE OUTER PACKAGING

OUTER WRAPPER LABEL ON MULTIPACK (CARTRIDGE. PumpCart – with blue box)

1. NAME OF THE MEDICINAL PRODUCT

NovoRapid PumpCart 100 units/ml solution for injection in cartridge
insulin aspart

2. STATEMENT OF ACTIVE SUBSTANCE

1 cartridge contains 1.6 ml equivalent to 160 units. 1 ml solution contains 100 units insulin aspart
(equivalent to 3.5 mg),

3. LIST OF EXCIPIENTS

glycerol, phenol, metacresol, zinc chloride, disodium phosphate dihydrate, sodium chloride,
hydrochloric acid/sodium hydroxide for pH adjustment and water for injections

4. PHARMACEUTICAL FORM AND CONTENTS

Solution for injection

Multipack: 25 (5 packs of 5) cartridges

5. METHOD AND ROUTES OF ADMINISTRATION

Read the package leaflet before use
Subcutaneous use

6. SPECIAL WARNING THAT THE MEDICINAL PRODUCT MUST BE STORED OUT OF THE SIGHT AND REACH OF CHILDREN

Keep out of the sight and reach of children

7. OTHER SPECIAL WARNINGS, IF NECESSARY

Use solution only if clear and colourless
For use by one person only
Only for use in pumps designed for NovoRapid PumpCart

8. EXPIRY DATE

EXP/
During use in pump: Use within 7 days

9. SPECIAL STORAGE CONDITIONS

Before opening: Store in a refrigerator (2°C to 8°C)

Carried as a spare: Can be kept for up to two weeks below 30°C

During use: Do not refrigerate. Store below 37°C

Do not freeze

Keep the cartridge in the outer carton in order to protect from light

10. SPECIAL PRECAUTIONS FOR DISPOSAL OF UNUSED MEDICINAL PRODUCTS OR WASTE MATERIALS DERIVED FROM SUCH MEDICINAL PRODUCTS, IF APPROPRIATE**11. NAME AND ADDRESS OF THE MARKETING AUTHORISATION HOLDER**

Novo Nordisk A/S
Novo Allé
DK-2880 Bagsværd
Denmark

12. MARKETING AUTHORISATION NUMBER

EU/1/99/119/025 25 (5 packs of 5) cartridges

13. BATCH NUMBER

Batch:

14. GENERAL CLASSIFICATION FOR SUPPLY**15. INSTRUCTIONS ON USE****16. INFORMATION IN BRAILLE**

NovoRapid PumpCart

17. UNIQUE IDENTIFIER – 2D BARCODE

2D barcode carrying the unique identifier included

18. UNIQUE IDENTIFIER – HUMAN READABLE DATA

PC
SN
NN

PARTICULARS TO APPEAR ON THE OUTER PACKAGING

INNER CARTON FOR MULTIPACK (CARTRIDGE. PumpCart – without blue box)

1. NAME OF THE MEDICINAL PRODUCT

NovoRapid PumpCart 100 units/ml solution for injection in cartridge
insulin aspart

2. STATEMENT OF ACTIVE SUBSTANCE

1 cartridge contains 1.6 ml equivalent to 160 units. 1 ml solution contains 100 units insulin aspart
(equivalent to 3.5 mg),

3. LIST OF EXCIPIENTS

glycerol, phenol, metacresol, zinc chloride, disodium phosphate dihydrate, sodium chloride,
hydrochloric acid/sodium hydroxide for pH adjustment and water for injections

4. PHARMACEUTICAL FORM AND CONTENTS

Solution for injection

5 x 1.6 ml cartridges. Component of a multipack, cannot be sold separately.

5. METHOD AND ROUTES OF ADMINISTRATION

Read the package leaflet before use
Subcutaneous use

6. SPECIAL WARNING THAT THE MEDICINAL PRODUCT MUST BE STORED OUT OF THE SIGHT AND REACH OF CHILDREN

Keep out of the sight and reach of children

7. OTHER SPECIAL WARNINGS, IF NECESSARY

Use solution only if clear and colourless
For use by one person only
Only for use in pumps designed for NovoRapid PumpCart

8. EXPIRY DATE

EXP/
During use in pump: Use within 7 days

9. SPECIAL STORAGE CONDITIONS

Before opening: Store in a refrigerator (2°C to 8°C)
Carried as a spare: Can be kept for up to two weeks below 30°C
During use: Do not refrigerate. Store below 37°C
Do not freeze
Keep the cartridge in the outer carton in order to protect from light

10. SPECIAL PRECAUTIONS FOR DISPOSAL OF UNUSED MEDICINAL PRODUCTS OR WASTE MATERIALS DERIVED FROM SUCH MEDICINAL PRODUCTS, IF APPROPRIATE**11. NAME AND ADDRESS OF THE MARKETING AUTHORISATION HOLDER**

Novo Nordisk A/S
Novo Allé
DK-2880 Bagsværd
Denmark

12. MARKETING AUTHORISATION NUMBER

EU/1/99/119/025 25 (5 packs of 5) cartridges

13. BATCH NUMBER

Batch:

14. GENERAL CLASSIFICATION FOR SUPPLY**15. INSTRUCTIONS ON USE****16. INFORMATION IN BRAILLE**

NovoRapid PumpCart

17. UNIQUE IDENTIFIER – 2D BARCODE**18. UNIQUE IDENTIFIER – HUMAN READABLE DATA**

B. PACKAGE LEAFLET

Package leaflet: Information for the user

NovoRapid 100 units/ml solution for injection in vial insulin aspart

Read all of this leaflet carefully before you start using this medicine because it contains important information for you.

- Keep this leaflet. You may need to read it again.
- If you have any further questions, ask your doctor, nurse or pharmacist.
- This medicine has been prescribed for you only. Do not pass it on to others. It may harm them, even if their signs of illness are the same as yours.
- If you get any side effects, talk with your doctor, nurse or pharmacist. This includes any possible side effects not listed in this leaflet. See section 4.

What is in this leaflet

1. What NovoRapid is and what it is used for
2. What you need to know before you use NovoRapid
3. How to use NovoRapid
4. Possible side effects
5. How to store NovoRapid
6. Contents of the pack and other information

1. What NovoRapid is and what it is used for

NovoRapid is a modern insulin (insulin analogue) with a rapid-acting effect. Modern insulin products are improved versions of human insulin.

NovoRapid is used to reduce the high blood sugar level in adults, adolescents and children aged 1 year and above with diabetes mellitus (diabetes). Diabetes is a disease where your body does not produce enough insulin to control the level of your blood sugar. Treatment with NovoRapid helps to prevent complications from your diabetes.

NovoRapid will start to lower your blood sugar 10–20 minutes after you inject it, a maximum effect occurs between 1 and 3 hours after the injection and the effect lasts for 3–5 hours. Due to this short action NovoRapid should normally be taken in combination with intermediate-acting or long-acting insulin preparations. Moreover NovoRapid can be used for continuous infusion in a pump system.

2. What you need to know before you use NovoRapid

Do not use NovoRapid

- ▶ If you are allergic to insulin aspart, or any of the other ingredients in this medicine (see section 6, Contents of the pack and other information).
- ▶ If you suspect hypoglycaemia (low blood sugar) is starting (see a) Summary of serious and very common side effects in section 4).
- ▶ If the protective cap is loose or missing. Each vial has a protective, tamper-proof plastic cap. If it is not in perfect condition when you get the vial, return the vial to your supplier.
- ▶ If it has not been stored correctly or been frozen (see section 5, How to store NovoRapid).
- ▶ If the insulin does not appear clear and colourless.

If any of these applies, do not use NovoRapid. Talk with your doctor, nurse or pharmacist for advice.

Before using NovoRapid

- ▶ Check the label to make sure it is the right type of insulin.
- ▶ Remove the protective cap.
- ▶ Always use a new needle for each injection to prevent contamination.
- ▶ Needles and syringes must not be shared.

Warnings and precautions

Some conditions and activities can affect your need for insulin. Consult your doctor:

- ▶ If you have trouble with your kidneys or liver, or with your adrenal, pituitary or thyroid glands.
- ▶ If you exercise more than usual or if you want to change your usual diet, as this may affect your blood sugar level.
- ▶ If you are ill, carry on taking your insulin and consult your doctor.
- ▶ If you are going abroad, travelling over time zones may affect your insulin needs and the timing of your injections.

Skin changes at the injection site

The injection site should be rotated to help prevent changes to the fatty tissue under the skin, such as skin thickening, skin shrinking or lumps under the skin. The insulin may not work very well if you inject into a lumpy, shrunken or thickened area (see section 3, How to use NovoRapid). Tell your doctor if you notice any skin changes at the injection site. Tell your doctor if you are currently injecting into these affected areas before you start injecting in a different area. Your doctor may tell you to check your blood sugar more closely, and to adjust your insulin or your other antidiabetic medications dose.

Children and adolescents

Do not give this medicine to children below 1 year of age since no clinical studies have been carried out in children below the age of 1 year.

Other medicines and NovoRapid

Tell your doctor, nurse or pharmacist if you are taking, have recently taken or might take any other medicines.

Some medicines affect your blood sugar level and this may mean that your insulin dose has to change. Listed below are the most common medicines which may affect your insulin treatment.

Your blood sugar level may fall (hypoglycaemia) if you take:

- Other medicines for the treatment of diabetes
- Monoamine oxidase inhibitors (MAOI) (used to treat depression)
- Beta-blockers (used to treat high blood pressure)
- Angiotensin converting enzyme (ACE) inhibitors (used to treat certain heart conditions or high blood pressure)
- Salicylates (used to relieve pain and lower fever)
- Anabolic steroids (such as testosterone)
- Sulphonamides (used to treat infections).

Your blood sugar level may rise (hyperglycaemia) if you take:

- Oral contraceptives (birth control pills)
- Thiazides (used to treat high blood pressure or excessive fluid retention)
- Glucocorticoids (such as 'cortisone' used to treat inflammation)
- Thyroid hormones (used to treat thyroid gland disorders)
- Sympathomimetics (such as epinephrine [adrenaline], or salbutamol, terbutaline used to treat asthma)

- Growth hormone (medicine for stimulation of skeletal and somatic growth and pronounced influence on the body's metabolic processes)
- Danazol (medicine acting on ovulation).

Octreotide and lanreotide (used for treatment of acromegaly, a rare hormonal disorder that usually occurs in middle-aged adults, caused by the pituitary gland producing excess growth hormone) may either increase or decrease your blood sugar level.

Beta-blockers (used to treat high blood pressure) may weaken or suppress entirely the first warning symptoms which help you to recognise low blood sugar.

Pioglitazone (tablets used for the treatment of type 2 diabetes)

Some patients with long-standing type 2 diabetes and heart disease or previous stroke who were treated with pioglitazone and insulin experienced the development of heart failure. Inform your doctor as soon as possible if you experience signs of heart failure such as unusual shortness of breath or rapid increase in weight or localised swelling (oedema).

If you have taken any of the medicines listed here, tell your doctor, nurse or pharmacist.

Drinking alcohol and taking NovoRapid

- ▶ If you drink alcohol, your need for insulin may change as your blood sugar level may either rise or fall. Careful monitoring is recommended.

Pregnancy and breast-feeding

- ▶ If you are pregnant, think you may be pregnant or are planning to have a baby, ask your doctor for advice before taking this medicine. NovoRapid can be used during pregnancy. Your insulin dose may need to be changed during pregnancy and after delivery. Careful control of your diabetes, particularly prevention of hypoglycaemia, is important for the health of your baby.
- ▶ There are no restrictions on treatment with NovoRapid during breast-feeding.

Ask your doctor, nurse or pharmacist for advice before taking this medicine while pregnant or breast-feeding.

Driving and using machines

- ▶ Please ask your doctor whether you can drive a car or operate a machine:
 - If you have frequent hypoglycaemia.
 - If you find it hard to recognise hypoglycaemia.

If your blood sugar is low or high, your concentration and ability to react might be affected and therefore also your ability to drive or operate a machine. Bear in mind that you could endanger yourself or others.

NovoRapid has a rapid onset of effect therefore if hypoglycaemia occurs, you may experience it earlier after an injection when compared to soluble human insulin.

Important information about some of the ingredients of NovoRapid

NovoRapid contains less than 1 mmol sodium (23 mg) per dose, i.e. NovoRapid is essentially 'sodium-free'.

3. How to use NovoRapid

Dose and when to take your insulin

Always use your insulin and adjust your dose exactly as your doctor has told you. Check with your doctor, nurse or pharmacist if you are not sure.

NovoRapid is generally taken immediately before a meal. Eat a meal or snack within 10 minutes of the injection to avoid low blood sugar. When necessary, NovoRapid can be given soon after a meal. See How and where to inject below for information.

Do not change your insulin unless your doctor tells you to. If your doctor has switched you from one type or brand of insulin to another, your dose may have to be adjusted by your doctor.

Use in children and adolescents

NovoRapid can be used in adolescents and children aged 1 year and above instead of soluble human insulin when a rapid onset of effect is preferred. For example, when it is difficult to dose the child in relation to meals.

Use in special patient groups

If you have reduced kidney or liver function, or if you are above 65 years of age, you need to check your blood sugar more regularly and discuss changes in your insulin dose with your doctor.

How and where to inject

NovoRapid is for injection under the skin (subcutaneously) or for continuous infusion in a pump system. Administration in a pump system will require a comprehensive instruction by your healthcare professional. You must never inject yourself directly into a vein (intravenously) or muscle (intramuscularly). If necessary NovoRapid can be given directly into a vein but this must only be done by physicians or other healthcare staff.

With each injection, change the injection site within the particular area of skin that you use. This may reduce the risk of developing lumps or skin pitting (see section 4, Possible side effects). The best places to give yourself an injection are: the front of your waist (abdomen), the upper arm or the front of your thighs. The insulin will work more quickly if injected into the front of your waist. You should always measure your blood sugar regularly.

NPH (Neutral Protamine Hagedorn) insulin is the only type of insulin that can be mixed with NovoRapid and the mixture must be injected immediately under your skin (subcutaneously). NovoRapid should be drawn into the syringe before you draw your NPH insulin.

How to take NovoRapid

If you use only one type of insulin

1. Draw into the syringe the same amount of air as the dose of insulin you are going to inject. Inject the air into the vial.
2. Turn the vial and syringe upside down and draw the correct insulin dose into the syringe. Pull the needle out of the vial. Then expel the air from the syringe and check that the dose is correct.

If you have to mix two types of insulin

1. Just before use, roll the NPH insulin between your hands until the liquid is uniformly white and cloudy.
2. Draw into the syringe the same amount of air as the dose of the NPH insulin. Inject the air into the vial containing the NPH insulin and pull out the needle.

3. Draw into the syringe the same amount of air as the dose of NovoRapid. Inject the air into the vial containing NovoRapid. Turn the vial and syringe upside down and draw up the prescribed dose of NovoRapid. Expel any air from the syringe and check that the dose is correct.
4. Push the needle into the vial of the NPH insulin, turn the vial and syringe upside down and draw out the dose you have been prescribed. Expel any air from the syringe and check the dose. Inject the mixture immediately.
5. Always mix NovoRapid and the NPH insulin in the same sequence.

How to inject NovoRapid

- ▶ Inject the insulin under the skin. Use the injection technique advised by your doctor or nurse.
- ▶ Keep the needle under your skin for at least 6 seconds to make sure you have injected all the insulin.
- ▶ Discard the needle after each injection.

For use in an infusion pump system

NovoRapid should never be mixed with any other insulin when used in a pump.

Follow the instructions and recommendations from your doctor regarding the use of NovoRapid in a pump. Before use of NovoRapid in the pump system, you must have received a comprehensive instruction in the use and information about any actions to be taken in case of illness, too high or too low blood sugar or failure of the pump system.

- Before inserting the needle, use soap and water to clean your hands and the skin where the needle is inserted to avoid any infection at the infusion site.
- When you fill a new reservoir, be certain not to leave large air bubbles in either the syringe or the tubing.
- Changing of the infusion set (tubing and needle) must be done according to the instructions in the product information supplied with the infusion set.

To get the benefit of insulin infusion, and to detect possible malfunction of the insulin pump, it is recommended that you measure your blood sugar level regularly.

What to do in case of pump system failure

You should always have an alternative delivery method for your insulin available for injection under the skin in case of pump system failure.

If you take more insulin than you should

If you take too much insulin your blood sugar gets too low (hypoglycaemia). See a) Summary of serious and very common side effects in section 4.

If you forget to take your insulin

If you forget to take your insulin your blood sugar may get too high (hyperglycaemia). See c) Effects from diabetes in section 4.

If you stop taking your insulin

Do not stop taking your insulin without speaking with a doctor, who will tell you what needs to be done. This could lead to very high blood sugar (severe hyperglycaemia) and ketoacidosis. See c) Effects from diabetes in section 4.

If you have any further questions on the use of this medicine, ask your doctor, nurse or pharmacist.

4. Possible side effects

Like all medicines, this medicine can cause side effects, although not everybody gets them.

a) Summary of serious and very common side effects

Low blood sugar (hypoglycaemia) is a very common side effect. It may affect more than 1 in 10 people.

Low blood sugar may occur if you:

- Inject too much insulin.
- Eat too little or miss a meal.
- Exercise more than usual.
- Drink alcohol (see Drinking alcohol and taking NovoRapid in section 2).

Signs of low blood sugar: Cold sweat; cool pale skin; headache; rapid heartbeat; feeling sick; feeling very hungry; temporary changes in vision; drowsiness; unusual tiredness and weakness; nervousness or tremor; feeling anxious; feeling confused; difficulty in concentrating.

Severe low blood sugar can lead to unconsciousness. If prolonged severe low blood sugar is not treated, it can cause brain damage (temporary or permanent) and even death. You may recover more quickly from unconsciousness with an injection of the hormone glucagon by someone who knows how to use it. If you are given glucagon, you will need glucose or a sugar snack as soon as you are conscious. If you do not respond to glucagon treatment, you will have to be treated in a hospital.

What to do if you experience low blood sugar:

- ▶ If you experience low blood sugar, eat glucose tablets or another high sugar snack (e.g. sweets, biscuits, fruit juice). Measure your blood sugar if possible and rest. Always carry glucose tablets or high sugar snacks with you, just in case.
- ▶ When symptoms of low blood sugar have disappeared or when blood sugar level is stabilised, continue insulin treatment as usual.
- ▶ If you have such a low blood sugar that it makes you pass out, if you have had need for injection of glucagon, or if you have experienced many incidents of low blood sugar, talk with a doctor. The amount or timing of insulin, food or exercise may need to be adjusted.

Tell relevant people that you have diabetes and what the consequences may be, including the risk of passing out (become unconscious) due to low blood sugar. Let them know that if you pass out, they must turn you on your side and get medical help straight away. They must not give you any food or drink due to risk of suffocation.

Serious allergic reactions to NovoRapid or one of its ingredients (called a systemic allergic reaction) is a very rare side effect but can potentially be life threatening. It may affect less than 1 in 10,000 people.

Seek medical advice immediately:

- If signs of allergy spread to other parts of your body.
- If you suddenly feel unwell, and you: start sweating; start being sick (vomiting); have difficulty in breathing; have a rapid heartbeat; feel dizzy.
- ▶ If you notice any of these signs, seek medical advice immediately.

Skin changes at the injection site: If you inject insulin at the same place, the fatty tissue may shrink (lipoatrophy) or thicken (lipohypertrophy) (may affect less than 1 in 100 people). Lumps under the skin may also be caused by build-up of a protein called amyloid (cutaneous amyloidosis; how often this occurs is not known). The insulin may not work very well if you inject into a lumpy, shrunken or thickened area. Change the injection site with each injection to help prevent these skin changes.

b) List of other side effects

Uncommon side effects

May affect less than 1 in 100 people.

Signs of allergy: Local allergic reactions (pain, redness, hives, inflammation, bruising, swelling and itching) at the injection site may occur. These usually disappear after a few weeks of taking your insulin. If they do not disappear, or if they spread throughout your body, talk to your doctor immediately. See also Serious allergic reactions above.

Vision problems: When you first start your insulin treatment, it may disturb your vision, but the disturbance is usually temporary.

Swollen joints: When you start taking insulin, water retention may cause swelling around your ankles and other joints. Normally this soon disappears. If not, talk to your doctor.

Diabetic retinopathy (an eye disease related to diabetes which can lead to loss of vision): If you have diabetic retinopathy and your blood sugar level improves very fast, the retinopathy may get worse. Ask your doctor about this.

Rare side effects

May affect less than 1 in 1,000 people.

Painful neuropathy (pain due to nerve damage): If your blood sugar level improves very fast, you may get nerve related pain. This is called acute painful neuropathy and is usually transient.

Reporting of side effects

If you get any side effects, talk with your doctor, nurse or pharmacist. This includes any possible side effects not listed in this leaflet. You can also report side effects directly via **the national reporting system** listed in [Appendix V](#). By reporting side effects you can help provide more information on the safety of this medicine.

c) Effects from diabetes

High blood sugar (hyperglycaemia)

High blood sugar may occur if you:

- Have not injected enough insulin.
- Forget to inject your insulin or stop taking insulin.
- Repeatedly inject less insulin than you need.
- Get an infection and/or a fever.
- Eat more than usual.
- Exercise less than usual.

Warning signs of high blood sugar:

The warning signs appear gradually. They include: increased urination; feeling thirsty; losing your appetite; feeling sick (nausea or vomiting); feeling drowsy or tired; flushed; dry skin; dry mouth and a fruity (acetone) smell of the breath.

What to do if you experience high blood sugar:

- ▶ If you get any of the above signs: test your blood sugar level, test your urine for ketones if you can, then seek medical advice immediately.
- ▶ These may be signs of a very serious condition called diabetic ketoacidosis (build-up of acid in the blood because the body is breaking down fat instead of sugar). If you do not treat it, this could lead to diabetic coma and eventually death.

5. How to store NovoRapid

Keep this medicine out of the sight and reach of children.

Do not use this medicine after the expiry date which is stated on the vial label and carton, after 'EXP'. The expiry date refers to the last day of that month.

Keep the vial in the outer carton in order to protect it from light.

Before opening: Store in a refrigerator at 2°C to 8°C, away from the cooling element. Do not freeze.

During use or when carried as a spare: The product may be stored for a maximum of 4 weeks. Store below 30°C. Do not refrigerate or freeze.

Discard the needle after each injection.

Do not throw away any medicines via wastewater or household waste. Ask your pharmacist how to throw away medicines you no longer use. These measures will help protect the environment.

6. Contents of the pack and other information

What NovoRapid contains

- The active substance is insulin aspart. Each ml contains 100 units of insulin aspart. Each vial contains 1,000 units of insulin aspart in 10 ml solution for injection.
- The other ingredients are glycerol, phenol, metacresol, zinc chloride, disodium phosphate dihydrate, sodium chloride, hydrochloric acid, sodium hydroxide and water for injections.

What NovoRapid looks like and contents of the pack

NovoRapid is presented as a solution for injection.

Pack sizes of 1 or 5 vials of 10 ml or a multipack of 5 packs of 1 x 10 ml vial. Not all pack sizes may be marketed.

The solution is clear and colourless.

Marketing Authorisation Holder and Manufacturer

Novo Nordisk A/S, Novo Allé, DK-2880 Bagsværd, Denmark

This leaflet was last revised in

Other sources of information

Detailed information on this medicine is available on the European Medicines Agency website: <http://www.ema.europa.eu>.

Package leaflet: Information for the user

NovoRapid Penfill 100 units/ml solution for injection in cartridge insulin aspart

Read all of this leaflet carefully before you start using this medicine because it contains important information for you.

- Keep this leaflet. You may need to read it again.
- If you have any further questions, ask your doctor, nurse or pharmacist.
- This medicine has been prescribed for you only. Do not pass it on to others. It may harm them, even if their signs of illness are the same as yours.
- If you get any side effects, talk with your doctor, nurse or pharmacist. This includes any possible side effects not listed in this leaflet. See section 4.

What is in this leaflet

1. What NovoRapid is and what it is used for
2. What you need to know before you use NovoRapid
3. How to use NovoRapid
4. Possible side effects
5. How to store NovoRapid
6. Contents of the pack and other information

1. What NovoRapid is and what it is used for

NovoRapid is a modern insulin (insulin analogue) with a rapid-acting effect. Modern insulin products are improved versions of human insulin.

NovoRapid is used to reduce the high blood sugar level in adults, adolescents and children aged 1 year and above with diabetes mellitus (diabetes). Diabetes is a disease where your body does not produce enough insulin to control the level of your blood sugar. Treatment with NovoRapid helps to prevent complications from your diabetes.

NovoRapid will start to lower your blood sugar 10–20 minutes after you inject it, a maximum effect occurs between 1 and 3 hours after the injection and the effect lasts for 3–5 hours. Due to this short action NovoRapid should normally be taken in combination with intermediate-acting or long-acting insulin preparations.

2. What you need to know before you use NovoRapid

Do not use NovoRapid

- ▶ If you are allergic to insulin aspart, or any of the other ingredients in this medicine (see section 6, Contents of the pack and other information).
- ▶ If you suspect hypoglycaemia (low blood sugar) is starting (see a) Summary of serious and very common side effects in section 4).
- ▶ If the cartridge or the device containing the cartridge is dropped, damaged or crushed.
- ▶ If it has not been stored correctly or been frozen (see section 5, How to store NovoRapid).
- ▶ If the insulin does not appear clear and colourless.

If any of these applies, do not use NovoRapid. Talk with your doctor, nurse or pharmacist for advice.

Before using NovoRapid

- ▶ Check the label to make sure it is the right type of insulin.
- ▶ Always check the cartridge, including the rubber plunger at the bottom of the cartridge. Do not use it if any damage is seen or if the rubber plunger has been drawn above the white label band at the bottom of the cartridge. This could be a result of leakage of insulin. If you suspect the cartridge is damaged, take it back to your supplier. See your pen manual for further instructions.
- ▶ Always use a new needle for each injection to prevent contamination.
- ▶ Needles and NovoRapid Penfill must not be shared.
- ▶ NovoRapid Penfill is only suitable for injecting under the skin using a reusable pen. Speak to your doctor if you need to inject your insulin by another method.

Warnings and precautions

Some conditions and activities can affect your need for insulin. Consult your doctor:

- ▶ If you have trouble with your kidneys or liver, or with your adrenal, pituitary or thyroid glands.
- ▶ If you exercise more than usual or if you want to change your usual diet, as this may affect your blood sugar level.
- ▶ If you are ill, carry on taking your insulin and consult your doctor.
- ▶ If you are going abroad, travelling over time zones may affect your insulin needs and the timing of your injections.

Skin changes at the injection site

The injection site should be rotated to help prevent changes to the fatty tissue under the skin, such as skin thickening, skin shrinking or lumps under the skin. The insulin may not work very well if you inject into a lumpy, shrunken or thickened area (see section 3, How to use NovoRapid). Tell your doctor if you notice any skin changes at the injection site. Tell your doctor if you are currently injecting into these affected areas before you start injecting in a different area. Your doctor may tell you to check your blood sugar more closely, and to adjust your insulin or your other antidiabetic medications dose.

Children and adolescents

Do not give this medicine to children below 1 year of age since no clinical studies have been carried out in children below the age of 1 year.

Other medicines and NovoRapid

Tell your doctor, nurse or pharmacist if you are taking, have recently taken or might take any other medicines.

Some medicines affect your blood sugar level and this may mean that your insulin dose has to change. Listed below are the most common medicines which may affect your insulin treatment.

Your blood sugar level may fall (hypoglycaemia) if you take:

- Other medicines for the treatment of diabetes
- Monoamine oxidase inhibitors (MAOI) (used to treat depression)
- Beta-blockers (used to treat high blood pressure)
- Angiotensin converting enzyme (ACE) inhibitors (used to treat certain heart conditions or high blood pressure)
- Salicylates (used to relieve pain and lower fever)
- Anabolic steroids (such as testosterone)
- Sulphonamides (used to treat infections).

Your blood sugar level may rise (hyperglycaemia) if you take:

- Oral contraceptives (birth control pills)
- Thiazides (used to treat high blood pressure or excessive fluid retention)
- Glucocorticoids (such as 'cortisone' used to treat inflammation)
- Thyroid hormones (used to treat thyroid gland disorders)
- Sympathomimetics (such as epinephrine [adrenaline], or salbutamol, terbutaline used to treat asthma)
- Growth hormone (medicine for stimulation of skeletal and somatic growth and pronounced influence on the body's metabolic processes)
- Danazol (medicine acting on ovulation).

Octreotide and lanreotide (used for treatment of acromegaly, a rare hormonal disorder that usually occurs in middle-aged adults, caused by the pituitary gland producing excess growth hormone) may either increase or decrease your blood sugar level.

Beta-blockers (used to treat high blood pressure) may weaken or suppress entirely the first warning symptoms which help you to recognise low blood sugar.

Pioglitazone (tablets used for the treatment of type 2 diabetes)

Some patients with long-standing type 2 diabetes and heart disease or previous stroke who were treated with pioglitazone and insulin experienced the development of heart failure. Inform your doctor as soon as possible if you experience signs of heart failure such as unusual shortness of breath or rapid increase in weight or localised swelling (oedema).

If you have taken any of the medicines listed here, tell your doctor, nurse or pharmacist.

Drinking alcohol and taking NovoRapid

- ▶ If you drink alcohol, your need for insulin may change as your blood sugar level may either rise or fall. Careful monitoring is recommended.

Pregnancy and breast-feeding

- ▶ If you are pregnant, think you may be pregnant or are planning to have a baby, ask your doctor for advice before taking this medicine. NovoRapid can be used during pregnancy. Your insulin dose may need to be changed during pregnancy and after delivery. Careful control of your diabetes, particularly prevention of hypoglycaemia, is important for the health of your baby.
- ▶ There are no restrictions on treatment with NovoRapid during breast-feeding.

Ask your doctor, nurse or pharmacist for advice before taking this medicine while pregnant or breast-feeding.

Driving and using machines

- ▶ Please ask your doctor whether you can drive a car or operate a machine:
 - If you have frequent hypoglycaemia.
 - If you find it hard to recognise hypoglycaemia.

If your blood sugar is low or high, your concentration and ability to react might be affected and therefore also your ability to drive or operate a machine. Bear in mind that you could endanger yourself or others.

NovoRapid has a rapid onset of effect therefore if hypoglycaemia occurs, you may experience it earlier after an injection when compared to soluble human insulin.

Important information about some of the ingredients of NovoRapid

NovoRapid contains less than 1 mmol sodium (23 mg) per dose, i.e. NovoRapid is essentially 'sodium-free'.

3. How to use NovoRapid

Dose and when to take your insulin

Always use your insulin and adjust your dose exactly as your doctor has told you. Check with your doctor, nurse or pharmacist if you are not sure.

NovoRapid is generally taken immediately before a meal. Eat a meal or snack within 10 minutes of the injection to avoid low blood sugar. When necessary, NovoRapid can be given soon after a meal. See How and where to inject below for information.

Do not change your insulin unless your doctor tells you to. If your doctor has switched you from one type or brand of insulin to another, your dose may have to be adjusted by your doctor.

Use in children and adolescents

NovoRapid can be used in adolescents and children aged 1 year and above instead of soluble human insulin when a rapid onset of effect is preferred. For example, when it is difficult to dose the child in relation to meals.

Use in special patient groups

If you have reduced kidney or liver function, or if you are above 65 years of age, you need to check your blood sugar more regularly and discuss changes in your insulin dose with your doctor.

How and where to inject

NovoRapid is for injection under the skin (subcutaneously). You must never inject yourself directly into a vein (intravenously) or muscle (intramuscularly). NovoRapid Penfill is only suitable for injecting under the skin using a reusable pen. Speak to your doctor if you need to inject your insulin by another method.

With each injection, change the injection site within the particular area of skin that you use. This may reduce the risk of developing lumps or skin pitting (see section 4, Possible side effects). The best places to give yourself an injection are: the front of your waist (abdomen), the upper arm or the front of your thighs. The insulin will work more quickly if injected into the front of your waist. You should always measure your blood sugar regularly.

- ▶ Do not refill the cartridge. Once empty, it must be disposed of.
- ▶ NovoRapid Penfill cartridges are designed to be used with Novo Nordisk insulin delivery systems and NovoFine or NovoTwist needles.
- ▶ If you are treated with NovoRapid Penfill and another insulin Penfill cartridge, you should use two insulin delivery systems, one for each type of insulin.
- ▶ Always carry a spare Penfill cartridge in case it is lost or damaged.

How to inject NovoRapid

- ▶ Inject the insulin under the skin. Use the injection technique advised by your doctor or nurse and as described in your pen manual.
- ▶ Keep the needle under your skin for at least 6 seconds. Keep the push-button fully depressed until the needle has been withdrawn from the skin. This will ensure correct delivery and limit possible flow of blood into the needle or insulin reservoir.
- ▶ Remove and discard the needle after each injection. Always store NovoRapid without the needle attached. Otherwise the liquid may leak out which can cause inaccurate dosing.

If you take more insulin than you should

If you take too much insulin your blood sugar gets too low (hypoglycaemia). See a) Summary of serious and very common side effects in section 4.

If you forget to take your insulin

If you forget to take your insulin your blood sugar may get too high (hyperglycaemia). See c) Effects from diabetes in section 4.

If you stop taking your insulin

Do not stop taking your insulin without speaking with a doctor, who will tell you what needs to be done. This could lead to very high blood sugar (severe hyperglycaemia) and ketoacidosis. See c) Effects from diabetes in section 4.

If you have any further questions on the use of this medicine, ask your doctor, nurse or pharmacist.

4. Possible side effects

Like all medicines, this medicine can cause side effects, although not everybody gets them.

a) Summary of serious and very common side effects

Low blood sugar (hypoglycaemia) is a very common side effect. It may affect more than 1 in 10 people.

Low blood sugar may occur if you:

- Inject too much insulin.
- Eat too little or miss a meal.
- Exercise more than usual.
- Drink alcohol (see Drinking alcohol and taking NovoRapid in section 2).

Signs of low blood sugar: Cold sweat; cool pale skin; headache; rapid heartbeat; feeling sick; feeling very hungry; temporary changes in vision; drowsiness; unusual tiredness and weakness; nervousness or tremor; feeling anxious; feeling confused; difficulty in concentrating.

Severe low blood sugar can lead to unconsciousness. If prolonged severe low blood sugar is not treated, it can cause brain damage (temporary or permanent) and even death. You may recover more quickly from unconsciousness with an injection of the hormone glucagon by someone who knows how to use it. If you are given glucagon, you will need glucose or a sugar snack as soon as you are conscious. If you do not respond to glucagon treatment, you will have to be treated in a hospital.

What to do if you experience low blood sugar:

- ▶ If you experience low blood sugar, eat glucose tablets or another high sugar snack (e.g. sweets, biscuits, fruit juice). Measure your blood sugar if possible and rest. Always carry glucose tablets or high sugar snacks with you, just in case.
- ▶ When symptoms of low blood sugar have disappeared or when blood sugar level is stabilised, continue insulin treatment as usual.
- ▶ If you have such a low blood sugar that it makes you pass out, if you have had need for injection of glucagon, or if you have experienced many incidents of low blood sugar, talk with a doctor. The amount or timing of insulin, food or exercise may need to be adjusted.

Tell relevant people that you have diabetes and what the consequences may be, including the risk of passing out (become unconscious) due to low blood sugar. Let them know that if you pass out, they must turn you on your side and get medical help straight away. They must not give you any food or drink due to risk of suffocation.

Serious allergic reactions to NovoRapid or one of its ingredients (called a systemic allergic reaction) is a very rare side effect but can potentially be life threatening. It may affect less than 1 in 10,000 people.

Seek medical advice immediately:

- If signs of allergy spread to other parts of your body.
- If you suddenly feel unwell, and you: start sweating; start being sick (vomiting); have difficulty in breathing; have a rapid heartbeat; feel dizzy.
- ▶ If you notice any of these signs, seek medical advice immediately.

Skin changes at the injection site: If you inject insulin at the same place, the fatty tissue may shrink (lipoatrophy) or thicken (lipohypertrophy) (may affect less than 1 in 100 people). Lumps under the skin may also be caused by build-up of a protein called amyloid (cutaneous amyloidosis; how often this occurs is not known). The insulin may not work very well if you inject into a lumpy, shrunken or thickened area. Change the injection site with each injection to help prevent these skin changes.

b) List of other side effects

Uncommon side effects

May affect less than 1 in 100 people.

Signs of allergy: Local allergic reactions (pain, redness, hives, inflammation, bruising, swelling and itching) at the injection site may occur. These usually disappear after a few weeks of taking your insulin. If they do not disappear, or if they spread throughout your body, talk to your doctor immediately. See also Serious allergic reactions above.

Vision problems: When you first start your insulin treatment, it may disturb your vision, but the disturbance is usually temporary.

Swollen joints: When you start taking insulin, water retention may cause swelling around your ankles and other joints. Normally this soon disappears. If not, talk to your doctor.

Diabetic retinopathy (an eye disease related to diabetes which can lead to loss of vision): If you have diabetic retinopathy and your blood sugar level improves very fast, the retinopathy may get worse. Ask your doctor about this.

Rare side effects

May affect less than 1 in 1,000 people.

Painful neuropathy (pain due to nerve damage): If your blood sugar level improves very fast, you may get nerve related pain. This is called acute painful neuropathy and is usually transient.

Reporting of side effects

If you get any side effects, talk with your doctor, nurse or pharmacist. This includes any possible side effects not listed in this leaflet. You can also report side effects directly via [the national reporting system listed in Appendix V](#). By reporting side effects you can help provide more information on the safety of this medicine.

c) Effects from diabetes

High blood sugar (hyperglycaemia)

High blood sugar may occur if you:

- Have not injected enough insulin.
- Forget to inject your insulin or stop taking insulin.
- Repeatedly inject less insulin than you need.
- Get an infection and/or a fever.
- Eat more than usual.
- Exercise less than usual.

Warning signs of high blood sugar:

The warning signs appear gradually. They include: increased urination; feeling thirsty; losing your appetite; feeling sick (nausea or vomiting); feeling drowsy or tired; flushed; dry skin; dry mouth and a fruity (acetone) smell of the breath.

What to do if you experience high blood sugar:

- ▶ If you get any of the above signs: test your blood sugar level, test your urine for ketones if you can, then seek medical advice immediately.
- ▶ These may be signs of a very serious condition called diabetic ketoacidosis (build-up of acid in the blood because the body is breaking down fat instead of sugar). If you do not treat it, this could lead to diabetic coma and eventually death.

5. How to store NovoRapid

Keep this medicine out of the sight and reach of children.

Do not use this medicine after the expiry date which is stated on the cartridge label and carton, after 'EXP'. The expiry date refers to the last day of that month.

Always keep the cartridge in the outer carton when you are not using it in order to protect it from light. NovoRapid must be protected from excessive heat and light.

Before opening: NovoRapid Penfill that is not being used is to be stored in the refrigerator at 2°C to 8°C, away from the cooling element. Do not freeze.

During use or when carried as a spare: NovoRapid Penfill that is being used or carried as a spare is not to be kept in the refrigerator. You can carry it with you and keep it at room temperature (below 30°C) for up to 4 weeks.

Do not throw away any medicines via wastewater or household waste. Ask your pharmacist how to throw away medicines you no longer use. These measures will help protect the environment.

6. Contents of the pack and other information

What NovoRapid contains

- The active substance is insulin aspart. Each ml contains 100 units of insulin aspart. Each cartridge contains 300 units of insulin aspart in 3 ml solution for injection.
- The other ingredients are glycerol, phenol, metacresol, zinc chloride, disodium phosphate dihydrate, sodium chloride, hydrochloric acid, sodium hydroxide and water for injections.

What NovoRapid looks like and contents of the pack

NovoRapid is presented as a solution for injection.

Pack sizes of 5 and 10 cartridges of 3 ml. Not all pack sizes may be marketed.

The solution is clear and colourless.

Marketing Authorisation Holder and Manufacturer

Marketing Authorisation Holder

Novo Nordisk A/S, Novo Allé, DK-2880 Bagsværd, Denmark

Manufacturer

The manufacturer can be identified by the batch number printed on the slip of the carton and on the label:

- If the second and third characters are S6, P5, K7, R7, VG, FG or ZF, the manufacturer is Novo Nordisk A/S, Novo Allé, DK-2880 Bagsværd, Denmark.
- If the second and third characters are H7 or T6, the manufacturer is Novo Nordisk Production SAS, 45 Avenue d'Orléans F-28000 Chartres, France.

This leaflet was last revised in

Other sources of information

Detailed information on this medicine is available on the European Medicines Agency website:

<http://www.ema.europa.eu>.

Package leaflet: Information for the user

NovoRapid FlexPen 100 units/ml solution for injection in pre-filled pen insulin aspart

Read all of this leaflet carefully before you start using this medicine because it contains important information for you.

- Keep this leaflet. You may need to read it again.
- If you have any further questions, ask your doctor, nurse or pharmacist.
- This medicine has been prescribed for you only. Do not pass it on to others. It may harm them, even if their signs of illness are the same as yours.
- If you get any side effects, talk with your doctor, nurse or pharmacist. This includes any possible side effects not listed in this leaflet. See section 4.

What is in this leaflet

1. What NovoRapid is and what it is used for
2. What you need to know before you use NovoRapid
3. How to use NovoRapid
4. Possible side effects
5. How to store NovoRapid
6. Contents of the pack and other information

1. What NovoRapid is and what it is used for

NovoRapid is a modern insulin (insulin analogue) with a rapid-acting effect. Modern insulin products are improved versions of human insulin.

NovoRapid is used to reduce the high blood sugar level in adults, adolescents and children aged 1 year and above with diabetes mellitus (diabetes). Diabetes is a disease where your body does not produce enough insulin to control the level of your blood sugar. Treatment with NovoRapid helps to prevent complications from your diabetes.

NovoRapid will start to lower your blood sugar 10–20 minutes after you inject it, a maximum effect occurs between 1 and 3 hours after the injection and the effect lasts for 3–5 hours. Due to this short action NovoRapid should normally be taken in combination with intermediate-acting or long-acting insulin preparations.

2. What you need to know before you use NovoRapid

Do not use NovoRapid

- ▶ If you are allergic to insulin aspart, or any of the other ingredients in this medicine (see section 6, Contents of the pack and other information).
- ▶ If you suspect hypoglycaemia (low blood sugar) is starting (see a) Summary of serious and very common side effects in section 4).
- ▶ If FlexPen is dropped, damaged or crushed.
- ▶ If it has not been stored correctly or been frozen (see section 5, How to store NovoRapid).
- ▶ If the insulin does not appear clear and colourless.

If any of these applies, do not use NovoRapid. Talk with your doctor, nurse or pharmacist for advice.

Before using NovoRapid

- ▶ Check the label to make sure it is the right type of insulin.
- ▶ Always use a new needle for each injection to prevent contamination.
- ▶ Needles and NovoRapid FlexPen must not be shared.
- ▶ NovoRapid FlexPen is only suitable for injecting under the skin. Speak to your doctor if you need to inject your insulin by another method.

Warnings and precautions

Some conditions and activities can affect your need for insulin. Consult your doctor:

- ▶ If you have trouble with your kidneys or liver, or with your adrenal, pituitary or thyroid glands.
- ▶ If you exercise more than usual or if you want to change your usual diet, as this may affect your blood sugar level.
- ▶ If you are ill, carry on taking your insulin and consult your doctor.
- ▶ If you are going abroad, travelling over time zones may affect your insulin needs and the timing of your injections.

Skin changes at the injection site

The injection site should be rotated to help prevent changes to the fatty tissue under the skin, such as skin thickening, skin shrinking or lumps under the skin. The insulin may not work very well if you inject into a lumpy, shrunken or thickened area (see section 3, How to use NovoRapid). Tell your doctor if you notice any skin changes at the injection site. Tell your doctor if you are currently injecting into these affected areas before you start injecting in a different area. Your doctor may tell you to check your blood sugar more closely, and to adjust your insulin or your other antidiabetic medications dose.

Children and adolescents

Do not give this medicine to children below 1 year of age since no clinical studies have been carried out in children below the age of 1 year.

Other medicines and NovoRapid

Tell your doctor, nurse or pharmacist if you are taking, have recently taken or might take any other medicines.

Some medicines affect your blood sugar level and this may mean that your insulin dose has to change. Listed below are the most common medicines which may affect your insulin treatment.

Your blood sugar level may fall (hypoglycaemia) if you take:

- Other medicines for the treatment of diabetes
- Monoamine oxidase inhibitors (MAOI) (used to treat depression)
- Beta-blockers (used to treat high blood pressure)
- Angiotensin converting enzyme (ACE) inhibitors (used to treat certain heart conditions or high blood pressure)
- Salicylates (used to relieve pain and lower fever)
- Anabolic steroids (such as testosterone)
- Sulphonamides (used to treat infections).

Your blood sugar level may rise (hyperglycaemia) if you take:

- Oral contraceptives (birth control pills)
- Thiazides (used to treat high blood pressure or excessive fluid retention)
- Glucocorticoids (such as 'cortisone' used to treat inflammation)
- Thyroid hormones (used to treat thyroid gland disorders)
- Sympathomimetics (such as epinephrine [adrenaline], or salbutamol, terbutaline used to treat asthma)

- Growth hormone (medicine for stimulation of skeletal and somatic growth and pronounced influence on the body's metabolic processes)
- Danazol (medicine acting on ovulation).

Octreotide and lanreotide (used for treatment of acromegaly, a rare hormonal disorder that usually occurs in middle-aged adults, caused by the pituitary gland producing excess growth hormone) may either increase or decrease your blood sugar level.

Beta-blockers (used to treat high blood pressure) may weaken or suppress entirely the first warning symptoms which help you to recognise low blood sugar.

Pioglitazone (tablets used for the treatment of type 2 diabetes)

Some patients with long-standing type 2 diabetes and heart disease or previous stroke who were treated with pioglitazone and insulin experienced the development of heart failure. Inform your doctor as soon as possible if you experience signs of heart failure such as unusual shortness of breath or rapid increase in weight or localised swelling (oedema).

If you have taken any of the medicines listed here, tell your doctor, nurse or pharmacist.

Drinking alcohol and taking NovoRapid

- ▶ If you drink alcohol, your need for insulin may change as your blood sugar level may either rise or fall. Careful monitoring is recommended.

Pregnancy and breast-feeding

- ▶ If you are pregnant, think you may be pregnant or are planning to have a baby, ask your doctor for advice before taking this medicine. NovoRapid can be used during pregnancy. Your insulin dose may need to be changed during pregnancy and after delivery. Careful control of your diabetes, particularly prevention of hypoglycaemia, is important for the health of your baby.
- ▶ There are no restrictions on treatment with NovoRapid during breast-feeding.

Ask your doctor, nurse or pharmacist for advice before taking this medicine while pregnant or breast-feeding.

Driving and using machines

- ▶ Please ask your doctor whether you can drive a car or operate a machine:
 - If you have frequent hypoglycaemia.
 - If you find it hard to recognise hypoglycaemia.

If your blood sugar is low or high, your concentration and ability to react might be affected and therefore also your ability to drive or operate a machine. Bear in mind that you could endanger yourself or others.

NovoRapid has a rapid onset of effect therefore if hypoglycaemia occurs, you may experience it earlier after an injection when compared to soluble human insulin.

Important information about some of the ingredients of NovoRapid

NovoRapid contains less than 1 mmol sodium (23 mg) per dose, i.e. NovoRapid is essentially 'sodium-free'.

3. How to use NovoRapid

Dose and when to take your insulin

Always use your insulin and adjust your dose exactly as your doctor has told you. Check with your doctor, nurse or pharmacist if you are not sure.

NovoRapid is generally taken immediately before a meal. Eat a meal or snack within 10 minutes of the injection to avoid low blood sugar. When necessary, NovoRapid can be given soon after a meal. See How and where to inject below for information.

Do not change your insulin unless your doctor tells you to. If your doctor has switched you from one type or brand of insulin to another, your dose may have to be adjusted by your doctor.

Use in children and adolescents

NovoRapid can be used in adolescents and children aged 1 year and above instead of soluble human insulin when a rapid onset of effect is preferred. For example, when it is difficult to dose the child in relation to meals.

Use in special patient groups

If you have reduced kidney or liver function, or if you are above 65 years of age, you need to check your blood sugar more regularly and discuss changes in your insulin dose with your doctor.

How and where to inject

NovoRapid is for injection under the skin (subcutaneously). You must never inject yourself directly into a vein (intravenously) or muscle (intramuscularly). NovoRapid FlexPen is only suitable for injecting under the skin. Speak to your doctor if you need to inject your insulin by another method.

With each injection, change the injection site within the particular area of skin that you use. This may reduce the risk of developing lumps or skin pitting (see section 4, Possible side effects). The best places to give yourself an injection are: the front of your waist (abdomen), the upper arm or the front of your thighs. The insulin will work more quickly if injected into the front of your waist. You should always measure your blood sugar regularly.

How to handle NovoRapid FlexPen

NovoRapid FlexPen is a pre-filled, colour-coded, disposable pen containing insulin aspart.

Read carefully the instructions on how to use NovoRapid FlexPen included in this package leaflet. You must use the pen as described in the instructions on how to use NovoRapid FlexPen.

Always ensure you use the correct pen before you inject your insulin.

If you take more insulin than you should

If you take too much insulin your blood sugar gets too low (hypoglycaemia). See a) Summary of serious and very common side effects in section 4.

If you forget to take your insulin

If you forget to take your insulin your blood sugar may get too high (hyperglycaemia). See c) Effects from diabetes in section 4.

If you stop taking your insulin

Do not stop taking your insulin without speaking with a doctor, who will tell you what needs to be done. This could lead to very high blood sugar (severe hyperglycaemia) and ketoacidosis. See c) Effects from diabetes in section 4.

If you have any further questions on the use of this medicine, ask your doctor, nurse or pharmacist.

4. Possible side effects

Like all medicines, this medicine can cause side effects, although not everybody gets them.

a) Summary of serious and very common side effects

Low blood sugar (hypoglycaemia) is a very common side effect. It may affect more than 1 in 10 people.

Low blood sugar may occur if you:

- Inject too much insulin.
- Eat too little or miss a meal.
- Exercise more than usual.
- Drink alcohol (see Drinking alcohol and taking NovoRapid in section 2).

Signs of low blood sugar: Cold sweat; cool pale skin; headache; rapid heartbeat; feeling sick; feeling very hungry; temporary changes in vision; drowsiness; unusual tiredness and weakness; nervousness or tremor; feeling anxious; feeling confused; difficulty in concentrating.

Severe low blood sugar can lead to unconsciousness. If prolonged severe low blood sugar is not treated, it can cause brain damage (temporary or permanent) and even death. You may recover more quickly from unconsciousness with an injection of the hormone glucagon by someone who knows how to use it. If you are given glucagon, you will need glucose or a sugar snack as soon as you are conscious. If you do not respond to glucagon treatment, you will have to be treated in a hospital.

What to do if you experience low blood sugar:

- ▶ If you experience low blood sugar, eat glucose tablets or another high sugar snack (e.g. sweets, biscuits, fruit juice). Measure your blood sugar if possible and rest. Always carry glucose tablets or high sugar snacks with you, just in case.
- ▶ When symptoms of low blood sugar have disappeared or when blood sugar level is stabilised, continue insulin treatment as usual.
- ▶ If you have such a low blood sugar that it makes you pass out, if you have had need for injection of glucagon, or if you have experienced many incidents of low blood sugar, talk with a doctor. The amount or timing of insulin, food or exercise may need to be adjusted.

Tell relevant people that you have diabetes and what the consequences may be, including the risk of passing out (become unconscious) due to low blood sugar. Let them know that if you pass out, they must turn you on your side and get medical help straight away. They must not give you any food or drink due to risk of suffocation.

Serious allergic reactions to NovoRapid or one of its ingredients (called a systemic allergic reaction) is a very rare side effect but can potentially be life threatening. It may affect less than 1 in 10,000 people.

Seek medical advice immediately:

- If signs of allergy spread to other parts of your body.
- If you suddenly feel unwell, and you: start sweating; start being sick (vomiting); have difficulty in breathing; have a rapid heartbeat; feel dizzy.
- ▶ If you notice any of these signs, seek medical advice immediately.

Skin changes at the injection site: If you inject insulin at the same place, the fatty tissue may shrink (lipoatrophy) or thicken (lipohypertrophy) (may affect less than 1 in 100 people). Lumps under the skin may also be caused by build-up of a protein called amyloid (cutaneous amyloidosis; how often this occurs is not known). The insulin may not work very well if you inject into a lumpy, shrunken or thickened area. Change the injection site with each injection to help prevent these skin changes.

b) List of other side effects

Uncommon side effects

May affect less than 1 in 100 people.

Signs of allergy: Local allergic reactions (pain, redness, hives, inflammation, bruising, swelling and itching) at the injection site may occur. These usually disappear after a few weeks of taking your insulin. If they do not disappear, or if they spread throughout your body, talk to your doctor immediately. See also Serious allergic reactions above.

Vision problems: When you first start your insulin treatment, it may disturb your vision, but the disturbance is usually temporary.

Swollen joints: When you start taking insulin, water retention may cause swelling around your ankles and other joints. Normally this soon disappears. If not, talk to your doctor.

Diabetic retinopathy (an eye disease related to diabetes which can lead to loss of vision): If you have diabetic retinopathy and your blood sugar level improves very fast, the retinopathy may get worse. Ask your doctor about this.

Rare side effects

May affect less than 1 in 1,000 people.

Painful neuropathy (pain due to nerve damage): If your blood sugar level improves very fast, you may get nerve related pain. This is called acute painful neuropathy and is usually transient.

Reporting of side effects

If you get any side effects, talk with your doctor, nurse or pharmacist. This includes any possible side effects not listed in this leaflet. You can also report side effects directly via **the national reporting system** listed in [Appendix V](#). By reporting side effects you can help provide more information on the safety of this medicine.

c) Effects from diabetes

High blood sugar (hyperglycaemia)

High blood sugar may occur if you:

- Have not injected enough insulin.
- Forget to inject your insulin or stop taking insulin.
- Repeatedly inject less insulin than you need.
- Get an infection and/or a fever.
- Eat more than usual.
- Exercise less than usual.

Warning signs of high blood sugar:

The warning signs appear gradually. They include: increased urination; feeling thirsty; losing your appetite; feeling sick (nausea or vomiting); feeling drowsy or tired; flushed; dry skin; dry mouth and a fruity (acetone) smell of the breath.

What to do if you experience high blood sugar:

- ▶ If you get any of the above signs: test your blood sugar level, test your urine for ketones if you can, then seek medical advice immediately.
- ▶ These may be signs of a very serious condition called diabetic ketoacidosis (build-up of acid in the blood because the body is breaking down fat instead of sugar). If you do not treat it, this could lead to diabetic coma and eventually death.

5. How to store NovoRapid

Keep this medicine out of the sight and reach of children.

Do not use this medicine after the expiry date which is stated on the FlexPen label and carton, after 'EXP'. The expiry date refers to the last day of that month.

Always keep the pen cap on your FlexPen when you are not using it in order to protect it from light. NovoRapid must be protected from excessive heat and light.

Before opening: NovoRapid FlexPen that is not being used is to be stored in the refrigerator at 2°C to 8°C, away from the cooling element. Do not freeze.

During use or when carried as a spare: You can carry your NovoRapid FlexPen with you and keep it at a temperature below 30°C or in a refrigerator (2°C to 8°C) for up to 4 weeks. If refrigerated, keep away from the cooling element. Do not freeze.

Do not throw away any medicines via wastewater or household waste. Ask your pharmacist how to throw away medicines you no longer use. These measures will help protect the environment.

6. Contents of the pack and other information

What NovoRapid contains

- The active substance is insulin aspart. Each ml contains 100 units of insulin aspart. Each pre-filled pen contains 300 units of insulin aspart in 3 ml solution for injection.
- The other ingredients are glycerol, phenol, metacresol, zinc chloride, disodium phosphate dihydrate, sodium chloride, hydrochloric acid, sodium hydroxide and water for injections.

What NovoRapid looks like and contents of the pack

NovoRapid is presented as a solution for injection.

Pack sizes of 1 (with or without needles), 5 (without needles) and 10 (without needles) pre-filled pens of 3 ml. Not all pack sizes may be marketed.

The solution is clear and colourless.

Marketing Authorisation Holder and Manufacturer

Marketing Authorisation Holder

Novo Nordisk A/S, Novo Allé, DK-2880 Bagsværd, Denmark

Manufacturer

The manufacturer can be identified by the batch number printed on the slip of the carton and on the label:

- If the second and third characters are S6, P5, K7, R7, VG, FG or ZF, the manufacturer is Novo Nordisk A/S, Novo Allé, DK-2880 Bagsværd, Denmark.
- If the second and third characters are H7 or T6, the manufacturer is Novo Nordisk Production SAS, 45 Avenue d'Orléans F-28000 Chartres, France.

Now turn over for information on how to use your FlexPen.

This leaflet was last revised in

Other sources of information

Detailed information on this medicine is available on the European Medicines Agency website:
<http://www.ema.europa.eu>.

Instructions on how to use NovoRapid solution for injection in FlexPen.

Read the following instructions carefully before using your FlexPen. If you do not follow the instructions carefully, you may get too little or too much insulin, which can lead to too high or too low blood sugar level.

Your FlexPen is a pre-filled dial-a-dose insulin pen. You can select doses from 1 to 60 units in increments of 1 unit. FlexPen is designed to be used with NovoFine or NovoTwist disposable needles up to a length of 8 mm. As a precautionary measure, always carry a spare insulin delivery device in case your FlexPen is lost or damaged.

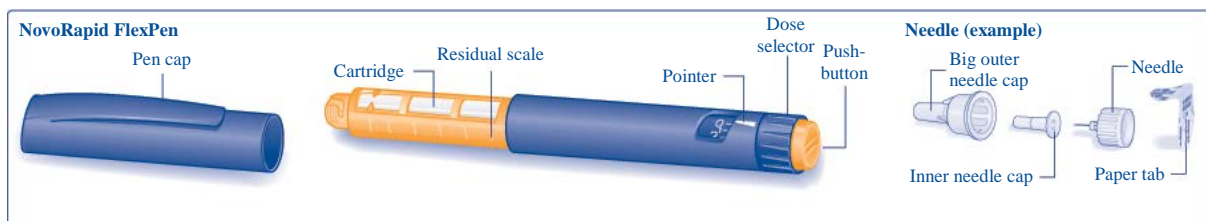

Caring for your pen

Your FlexPen must be handled with care.

If it is dropped, damaged or crushed, there is a risk of insulin leakage. This may cause inaccurate dosing, which can lead to too high or too low blood sugar level.

You can clean the exterior of your FlexPen by wiping it with a medicinal swab. Do not soak it, wash or lubricate it as it may damage the pen.

Do not refill your FlexPen. Once empty, it must be disposed of.

Preparing your NovoRapid FlexPen

Check the name and coloured label of your pen to make sure that it contains the correct type of insulin. This is especially important if you take more than one type of insulin. If you take the wrong type of insulin, your blood sugar level may get too high or too low.

A

Pull off the pen cap.



B

Remove the paper tab from a new disposable needle.

Screw the needle straight and tightly onto your FlexPen.



C

Pull off the big outer needle cap and keep it for later.



D

Pull off the inner needle cap and dispose of it.

Never try to put the inner needle cap back on the needle. You may stick yourself with the needle.



⚠ Always use a new needle for each injection. This reduces the risk of contamination, infection, leakage of insulin, blocked needles and inaccurate dosing.

⚠ Be careful not to bend or damage the needle before use.

Checking the insulin flow

Prior to each injection small amounts of air may collect in the cartridge during normal use. To avoid injection of air and ensure proper dosing:

E

Turn the dose selector to select 2 units.



F

Hold your FlexPen with the needle pointing upwards and tap the cartridge gently with your finger a few times to make any air bubbles collect at the top of the cartridge.



G

Keeping the needle upwards, press the push-button all the way in. The dose selector returns to 0.

A drop of insulin should appear at the needle tip. If not, change the needle and repeat the procedure no more than 6 times.

If a drop of insulin still does not appear, the pen is defective, and you must use a new one.

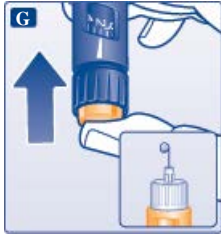

- ⚠ Always make sure that a drop appears at the needle tip before you inject. This makes sure that the insulin flows. If no drop appears, you will not inject any insulin, even though the dose selector may move. This may indicate a blocked or damaged needle.
- ⚠ Always check the flow before you inject. If you do not check the flow, you may get too little insulin or no insulin at all. This may lead to too high blood sugar level.

Selecting your dose

Check that the dose selector is set at 0.

H

Turn the dose selector to select the number of units you need to inject.

The dose can be corrected either up or down by turning the dose selector in either direction until the correct dose lines up with the pointer. When turning the dose selector, be careful not to push the push-button as insulin will come out.

You cannot select a dose larger than the number of units left in the cartridge.

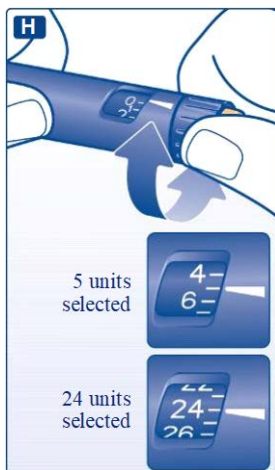

- ⚠ Always use the dose selector and the pointer to see how many units you have selected before injecting the insulin.
- ⚠ Do not count the pen clicks. If you select and inject the wrong dose, your blood sugar level may get too high or too low. Do not use the residual scale, it only shows approximately how much insulin is left in your pen.

Making the injection

Insert the needle into your skin. Use the injection technique shown by your doctor or nurse.

I

Inject the dose by pressing the push-button all the way in until 0 lines up with the pointer. Be careful

only to push the push-button when injecting.

Turning the dose selector will not inject insulin.



J

Keep the push-button fully depressed and let the needle remain under the skin for at least 6 seconds. This will make sure you get the full dose.

Withdraw the needle from the skin, then release the pressure on the push-button.

Always make sure that the dose selector returns to 0 after the injection. If the dose selector stops before it returns to 0, the full dose has not been delivered, which may result in too high blood sugar level.

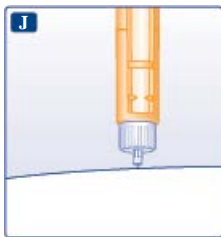

K

Lead the needle into the big outer needle cap without touching it. When the needle is covered, carefully push the big outer needle cap completely on and then unscrew the needle.

Dispose of it carefully and put the pen cap back on.

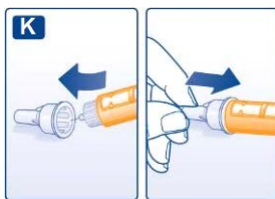

- ⚠ Always remove the needle after each injection and store your FlexPen without the needle attached. This reduces the risk of contamination, infection, leakage of insulin, blocked needles and inaccurate dosing.

Further important information

- ⚠ Caregivers must be very careful when handling used needles – to reduce the risk of needle sticks and cross-infection.
- ⚠ Dispose of your used FlexPen carefully without the needle attached.
- ⚠ Never share your pen or your needles with other people. It might lead to cross-infection.

- ⚠ Never share your pen with other people. Your medicine might be harmful to their health.
- ⚠ Always keep your pen and needles out of sight and reach of others, especially children.

Package leaflet: Information for the user

NovoRapid InnoLet 100 units/ml solution for injection in pre-filled pen insulin aspart

Read all of this leaflet carefully before you start using this medicine because it contains important information for you.

- Keep this leaflet. You may need to read it again.
- If you have any further questions, ask your doctor, nurse or pharmacist.
- This medicine has been prescribed for you only. Do not pass it on to others. It may harm them, even if their signs of illness are the same as yours.
- If you get any side effects, talk with your doctor, nurse or pharmacist. This includes any possible side effects not listed in this leaflet. See section 4.

What is in this leaflet

1. What NovoRapid is and what it is used for
2. What you need to know before you use NovoRapid
3. How to use NovoRapid
4. Possible side effects
5. How to store NovoRapid
6. Contents of the pack and other information

1. What NovoRapid is and what it is used for

NovoRapid is a modern insulin (insulin analogue) with a rapid-acting effect. Modern insulin products are improved versions of human insulin.

NovoRapid is used to reduce the high blood sugar level in adults, adolescents and children aged 1 year and above with diabetes mellitus (diabetes). Diabetes is a disease where your body does not produce enough insulin to control the level of your blood sugar. Treatment with NovoRapid helps to prevent complications from your diabetes.

NovoRapid will start to lower your blood sugar 10–20 minutes after you inject it, a maximum effect occurs between 1 and 3 hours after the injection and the effect lasts for 3–5 hours. Due to this short action NovoRapid should normally be taken in combination with intermediate-acting or long-acting insulin preparations.

2. What you need to know before you use NovoRapid

Do not use NovoRapid

- ▶ If you are allergic to insulin aspart, or any of the other ingredients in this medicine (see section 6, Contents of the pack and other information).
- ▶ If you suspect hypoglycaemia (low blood sugar) is starting (see a) Summary of serious and very common side effects in section 4).
- ▶ If InnoLet is dropped, damaged or crushed.
- ▶ If it has not been stored correctly or been frozen (see section 5, How to store NovoRapid).
- ▶ If the insulin does not appear clear and colourless.

If any of these applies, do not use NovoRapid. Talk with your doctor, nurse or pharmacist for advice.

Before using NovoRapid

- ▶ Check the label to make sure it is the right type of insulin.
- ▶ Always use a new needle for each injection to prevent contamination.
- ▶ Needles and NovoRapid InnoLet must not be shared.
- ▶ NovoRapid InnoLet is only suitable for injecting under the skin. Speak to your doctor if you need to inject your insulin by another method.

Warnings and precautions

Some conditions and activities can affect your need for insulin. Consult your doctor:

- ▶ If you have trouble with your kidneys or liver, or with your adrenal, pituitary or thyroid glands.
- ▶ If you exercise more than usual or if you want to change your usual diet, as this may affect your blood sugar level.
- ▶ If you are ill, carry on taking your insulin and consult your doctor.
- ▶ If you are going abroad, travelling over time zones may affect your insulin needs and the timing of your injections.

Skin changes at the injection site

The injection site should be rotated to help prevent changes to the fatty tissue under the skin, such as skin thickening, skin shrinking or lumps under the skin. The insulin may not work very well if you inject into a lumpy, shrunken or thickened area (see section 3, How to use NovoRapid). Tell your doctor if you notice any skin changes at the injection site. Tell your doctor if you are currently injecting into these affected areas before you start injecting in a different area. Your doctor may tell you to check your blood sugar more closely, and to adjust your insulin or your other antidiabetic medications dose.

Children and adolescents

Do not give this medicine to children below 1 year of age since no clinical studies have been carried out in children below the age of 1 year.

Other medicines and NovoRapid

Tell your doctor, nurse or pharmacist if you are taking, have recently taken or might take any other medicines.

Some medicines affect your blood sugar level and this may mean that your insulin dose has to change. Listed below are the most common medicines which may affect your insulin treatment.

Your blood sugar level may fall (hypoglycaemia) if you take:

- Other medicines for the treatment of diabetes
- Monoamine oxidase inhibitors (MAOI) (used to treat depression)
- Beta-blockers (used to treat high blood pressure)
- Angiotensin converting enzyme (ACE) inhibitors (used to treat certain heart conditions or high blood pressure)
- Salicylates (used to relieve pain and lower fever)
- Anabolic steroids (such as testosterone)
- Sulphonamides (used to treat infections).

Your blood sugar level may rise (hyperglycaemia) if you take:

- Oral contraceptives (birth control pills)
- Thiazides (used to treat high blood pressure or excessive fluid retention)
- Glucocorticoids (such as 'cortisone' used to treat inflammation)
- Thyroid hormones (used to treat thyroid gland disorders)
- Sympathomimetics (such as epinephrine [adrenaline], or salbutamol, terbutaline used to treat asthma)

- Growth hormone (medicine for stimulation of skeletal and somatic growth and pronounced influence on the body's metabolic processes)
- Danazol (medicine acting on ovulation).

Octreotide and lanreotide (used for treatment of acromegaly, a rare hormonal disorder that usually occurs in middle-aged adults, caused by the pituitary gland producing excess growth hormone) may either increase or decrease your blood sugar level.

Beta-blockers (used to treat high blood pressure) may weaken or suppress entirely the first warning symptoms which help you to recognise low blood sugar.

Pioglitazone (tablets used for the treatment of type 2 diabetes)

Some patients with long-standing type 2 diabetes and heart disease or previous stroke who were treated with pioglitazone and insulin experienced the development of heart failure. Inform your doctor as soon as possible if you experience signs of heart failure such as unusual shortness of breath or rapid increase in weight or localised swelling (oedema).

If you have taken any of the medicines listed here, tell your doctor, nurse or pharmacist.

Drinking alcohol and taking NovoRapid

- ▶ If you drink alcohol, your need for insulin may change as your blood sugar level may either rise or fall. Careful monitoring is recommended.

Pregnancy and breast-feeding

- ▶ If you are pregnant, think you may be pregnant or are planning to have a baby, ask your doctor for advice before taking this medicine. NovoRapid can be used during pregnancy. Your insulin dose may need to be changed during pregnancy and after delivery. Careful control of your diabetes, particularly prevention of hypoglycaemia, is important for the health of your baby.
- ▶ There are no restrictions on treatment with NovoRapid during breast-feeding.

Ask your doctor, nurse or pharmacist for advice before taking this medicine while pregnant or breast-feeding.

Driving and using machines

- ▶ Please ask your doctor whether you can drive a car or operate a machine:
 - If you have frequent hypoglycaemia.
 - If you find it hard to recognise hypoglycaemia.

If your blood sugar is low or high, your concentration and ability to react might be affected and therefore also your ability to drive or operate a machine. Bear in mind that you could endanger yourself or others.

NovoRapid has a rapid onset of effect therefore if hypoglycaemia occurs, you may experience it earlier after an injection when compared to soluble human insulin.

Important information about some of the ingredients of NovoRapid

NovoRapid contains less than 1 mmol sodium (23 mg) per dose, i.e. NovoRapid is essentially 'sodium-free'.

3. How to use NovoRapid

Dose and when to take your insulin

Always use your insulin and adjust your dose exactly as your doctor has told you. Check with your doctor, nurse or pharmacist if you are not sure.

NovoRapid is generally taken immediately before a meal. Eat a meal or snack within 10 minutes of the injection to avoid low blood sugar. When necessary, NovoRapid can be given soon after a meal. See How and where to inject below for information.

Do not change your insulin unless your doctor tells you to. If your doctor has switched you from one type or brand of insulin to another, your dose may have to be adjusted by your doctor.

Use in children and adolescents

NovoRapid can be used in adolescents and children aged 1 year and above instead of soluble human insulin when a rapid onset of effect is preferred. For example, when it is difficult to dose the child in relation to meals.

Use in special patient groups

If you have reduced kidney or liver function, or if you are above 65 years of age, you need to check your blood sugar more regularly and discuss changes in your insulin dose with your doctor.

How and where to inject

NovoRapid is for injection under the skin (subcutaneously). You must never inject yourself directly into a vein (intravenously) or muscle (intramuscularly). NovoRapid InnoLet is only suitable for injecting under the skin. Speak to your doctor if you need to inject your insulin by another method.

With each injection, change the injection site within the particular area of skin that you use. This may reduce the risk of developing lumps or skin pitting (see section 4, Possible side effects). The best places to give yourself an injection are: the front of your waist (abdomen), the upper arm or the front of your thighs. The insulin will work more quickly if injected into the front of your waist. You should always measure your blood sugar regularly.

How to handle NovoRapid InnoLet

NovoRapid InnoLet is a pre-filled disposable pen containing insulin aspart.

Read carefully the instructions on how to use NovoRapid InnoLet included in this package leaflet. You must use the pen as described in the instructions on how to use NovoRapid Innolet.

Always ensure you use the correct pen before you inject your insulin.

If you take more insulin than you should

If you take too much insulin your blood sugar gets too low (hypoglycaemia). See a) Summary of serious and very common side effects in section 4.

If you forget to take your insulin

If you forget to take your insulin your blood sugar may get too high (hyperglycaemia). See c) Effects from diabetes in section 4.

If you stop taking your insulin

Do not stop taking your insulin without speaking with a doctor, who will tell you what needs to be done. This could lead to very high blood sugar (severe hyperglycaemia) and ketoacidosis. See c) Effects from diabetes in section 4.

If you have any further questions on the use of this medicine, ask your doctor, nurse or pharmacist.

4. Possible side effects

Like all medicines, this medicine can cause side effects, although not everybody gets them.

a) Summary of serious and very common side effects

Low blood sugar (hypoglycaemia) is a very common side effect. It may affect more than 1 in 10 people.

Low blood sugar may occur if you:

- Inject too much insulin.
- Eat too little or miss a meal.
- Exercise more than usual.
- Drink alcohol (see Drinking alcohol and taking NovoRapid in section 2).

Signs of low blood sugar: Cold sweat; cool pale skin; headache; rapid heartbeat; feeling sick; feeling very hungry; temporary changes in vision; drowsiness; unusual tiredness and weakness; nervousness or tremor; feeling anxious; feeling confused; difficulty in concentrating.

Severe low blood sugar can lead to unconsciousness. If prolonged severe low blood sugar is not treated, it can cause brain damage (temporary or permanent) and even death. You may recover more quickly from unconsciousness with an injection of the hormone glucagon by someone who knows how to use it. If you are given glucagon, you will need glucose or a sugar snack as soon as you are conscious. If you do not respond to glucagon treatment, you will have to be treated in a hospital.

What to do if you experience low blood sugar:

- ▶ If you experience low blood sugar, eat glucose tablets or another high sugar snack (e.g. sweets, biscuits, fruit juice). Measure your blood sugar if possible and rest. Always carry glucose tablets or high sugar snacks with you, just in case.
- ▶ When symptoms of low blood sugar have disappeared or when blood sugar level is stabilised, continue insulin treatment as usual.
- ▶ If you have such a low blood sugar that it makes you pass out, if you have had need for injection of glucagon, or if you have experienced many incidents of low blood sugar, talk with a doctor. The amount or timing of insulin, food or exercise may need to be adjusted.

Tell relevant people that you have diabetes and what the consequences may be, including the risk of passing out (become unconscious) due to low blood sugar. Let them know that if you pass out, they must turn you on your side and get medical help straight away. They must not give you any food or drink due to risk of suffocation.

Serious allergic reactions to NovoRapid or one of its ingredients (called a systemic allergic reaction) is a very rare side effect but can potentially be life threatening. It may affect less than 1 in 10,000 people.

Seek medical advice immediately:

- If signs of allergy spread to other parts of your body.
- If you suddenly feel unwell, and you: start sweating; start being sick (vomiting); have difficulty in breathing; have a rapid heartbeat; feel dizzy.
- ▶ If you notice any of these signs, seek medical advice immediately.

Skin changes at the injection site: If you inject insulin at the same place, the fatty tissue may shrink (lipoatrophy) or thicken (lipohypertrophy) (may affect less than 1 in 100 people). Lumps under the skin may also be caused by build-up of a protein called amyloid (cutaneous amyloidosis; how often this occurs is not known). The insulin may not work very well if you inject into a lumpy, shrunken or thickened area. Change the injection site with each injection to help prevent these skin changes.

b) List of other side effects

Uncommon side effects

May affect less than 1 in 100 people.

Signs of allergy: Local allergic reactions (pain, redness, hives, inflammation, bruising, swelling and itching) at the injection site may occur. These usually disappear after a few weeks of taking your insulin. If they do not disappear, or if they spread throughout your body, talk to your doctor immediately. See also Serious allergic reactions above.

Vision problems: When you first start your insulin treatment, it may disturb your vision, but the disturbance is usually temporary.

Swollen joints: When you start taking insulin, water retention may cause swelling around your ankles and other joints. Normally this soon disappears. If not, talk to your doctor.

Diabetic retinopathy (an eye disease related to diabetes which can lead to loss of vision): If you have diabetic retinopathy and your blood sugar level improves very fast, the retinopathy may get worse. Ask your doctor about this.

Rare side effects

May affect less than 1 in 1,000 people.

Painful neuropathy (pain due to nerve damage): If your blood sugar level improves very fast, you may get nerve related pain. This is called acute painful neuropathy and is usually transient.

Reporting of side effects

If you get any side effects, talk with your doctor, nurse or pharmacist. This includes any possible side effects not listed in this leaflet. You can also report side effects directly via [the national reporting system listed in Appendix V](#). By reporting side effects you can help provide more information on the safety of this medicine.

c) Effects from diabetes

High blood sugar (hyperglycaemia)

High blood sugar may occur if you:

- Have not injected enough insulin.
- Forget to inject your insulin or stop taking insulin.
- Repeatedly inject less insulin than you need.
- Get an infection and/or a fever.
- Eat more than usual.
- Exercise less than usual.

Warning signs of high blood sugar:

The warning signs appear gradually. They include: increased urination; feeling thirsty; losing your appetite; feeling sick (nausea or vomiting); feeling drowsy or tired; flushed; dry skin; dry mouth and a fruity (acetone) smell of the breath.

What to do if you experience high blood sugar:

- ▶ If you get any of the above signs: test your blood sugar level, test your urine for ketones if you can, then seek medical advice immediately.
- ▶ These may be signs of a very serious condition called diabetic ketoacidosis (build-up of acid in the blood because the body is breaking down fat instead of sugar). If you do not treat it, this could lead to diabetic coma and eventually death.

5. How to store NovoRapid

Keep this medicine out of the sight and reach of children.

Do not use this medicine after the expiry date which is stated on the InnoLet label and carton, after 'EXP'. The expiry date refers to the last day of that month.

Always keep the pen cap on your InnoLet when you are not using it in order to protect it from light. NovoRapid must be protected from excessive heat and light.

Before opening: NovoRapid InnoLet that is not being used is to be stored in the refrigerator at 2°C to 8°C, away from the cooling element. Do not freeze.

During use or when carried as a spare: NovoRapid InnoLet that is being used or carried as a spare is not to be kept in the refrigerator. You can carry it with you and keep it at room temperature (below 30°C) for up to 4 weeks.

Do not throw away any medicines via wastewater or household waste. Ask your pharmacist how to throw away medicines you no longer use. These measures will help protect the environment.

6. Contents of the pack and other information

What NovoRapid contains

- The active substance is insulin aspart. Each ml contains 100 units of insulin aspart. Each pre-filled pen contains 300 units of insulin aspart in 3 ml solution for injection.
- The other ingredients are glycerol, phenol, metacresol, zinc chloride, disodium phosphate dihydrate, sodium chloride, hydrochloric acid, sodium hydroxide and water for injections.

What NovoRapid looks like and contents of the pack

NovoRapid is presented as a solution for injection.

Pack sizes of 1, 5 and 10 pre-filled pens of 3 ml. Not all pack sizes may be marketed.

The solution is clear and colourless.

Marketing Authorisation Holder and Manufacturer

Novo Nordisk A/S, Novo Allé, DK-2880 Bagsværd, Denmark

Now turn over for information on how to use your InnoLet.

This leaflet was last revised in

Other sources of information

Detailed information on this medicine is available on the European Medicines Agency website:
<http://www.ema.europa.eu>.

Instructions on how to use NovoRapid solution for injection in InnoLet

Read the instructions carefully before using your InnoLet. If you do not follow the instructions carefully, you may get too little or too much insulin, which can lead to too high or too low blood sugar level.

Your InnoLet is a simple, compact pre-filled pen able to deliver 1 to 50 units in increments of 1 unit. InnoLet is designed to be used with NovoFine or NovoTwist disposable needles up to a length of 8 mm. As a precautionary measure, always carry a spare insulin delivery device in case your InnoLet is lost or damaged.

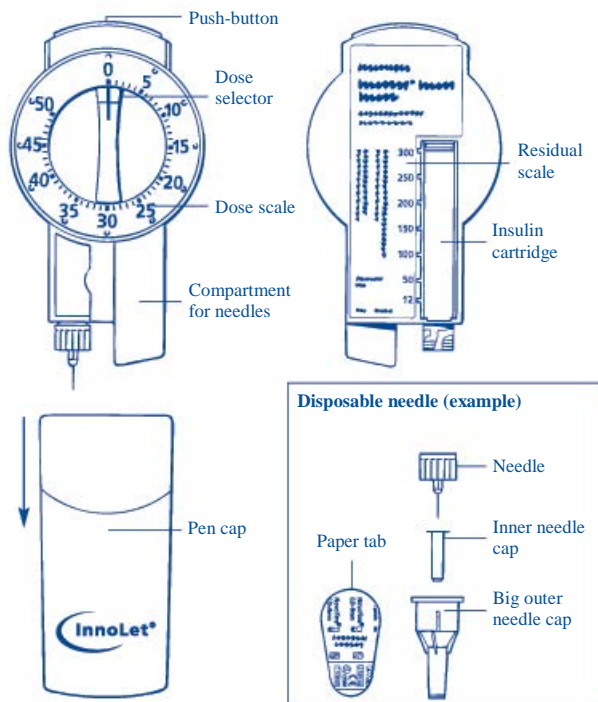

Getting started

Check the name and coloured label of your InnoLet to make sure that it contains the correct type of insulin. This is especially important if you take more than one type of insulin. If you take the wrong type of insulin, your blood sugar level may get too high or too low.

Take off the pen cap.

Attaching the needle

- **Always use a new needle** for each injection. This reduces the risk of contamination, infection, leakage of insulin, blocked needles and inaccurate dosing.
- Be careful not to bend or damage the needle before use.
- **Remove the paper tab** from a new disposable needle.
- **Screw the needle straight and tightly** onto your InnoLet (picture 1A).
- **Pull off the big outer needle cap and the inner needle cap.** You may want to store the big outer needle cap in the compartment.
Never try to put the inner needle cap back on the needle. You may stick yourself with the needle.

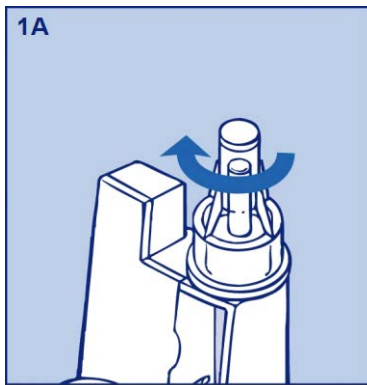

Priming to expel air prior to each injection

Small amounts of air may collect in the needle and cartridge during normal use.

To avoid injection of air and ensure proper dosing:

- **Dial 2 units** by turning the dose selector clockwise.
- **Hold your InnoLet with the needle upwards and tap the cartridge gently** with your finger a few times (picture **1B**) to make any air bubbles collect at the top of the cartridge.
- **Keeping the needle upwards, press the push-button** and the dose selector returns to 0.
- **Always make sure that a drop appears at the needle tip** before injection (picture **1B**). This makes sure the insulin flows. If not, change the needle and repeat the procedure no more than 6 times.

If a drop of insulin still does not appear, the device is defective and must not be used.

- If no drop appears, you will not inject any insulin, even though the dose selector may move. This may indicate a blocked or damaged needle.
- Always prime InnoLet before you inject. If you do not prime InnoLet, you may get too little insulin or no insulin at all. This may lead to too high blood sugar level.

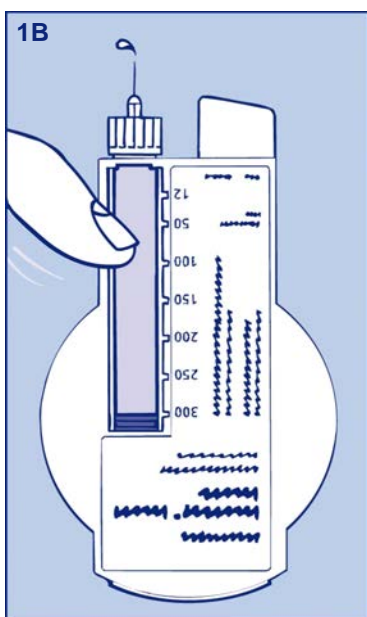

Setting the dose

- **Always check that the push-button is fully depressed and the dose selector is set to 0.**
- **Dial the number of units required** by turning the dose selector clockwise (picture **2**).

- **You will hear a click for every single unit dialled.** The dose can be corrected by turning the dial either way. Make sure not to turn the dial or correct the dose when the needle is inserted in the skin. This may lead to inaccurate dosing that can make your blood sugar level too high or too low.

Always use the dose scale and the dose selector to see how many units you have selected before injecting the insulin. Do not count the pen clicks. If you select and inject the wrong dose, your blood sugar level may get too high or too low. Do not use the residual scale, it only shows approximately how much insulin is left in your pen.

You cannot set a dose larger than the number of units remaining in the cartridge.

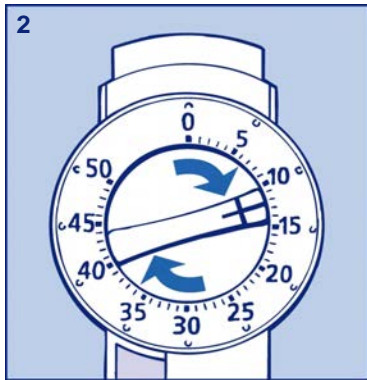

Injecting the insulin

- **Insert the needle into your skin.** Use the injection technique advised by your doctor.
- **Deliver the dose by pressing the push-button fully down** (picture 3). You will hear clicks as the dose selector returns to 0.
- **After the injection, the needle should remain under the skin for at least 6 seconds** to ensure that the full dose has been delivered.
- **Make sure not to block the dose selector while injecting,** as the dose selector must be allowed to return to 0 when you press the push-button. Always make sure that the dose selector returns to 0 after the injection. If the dose selector stops before it returns to 0, the full dose has not been delivered, which may result in too high blood sugar level.
- Discard the needle after each injection.

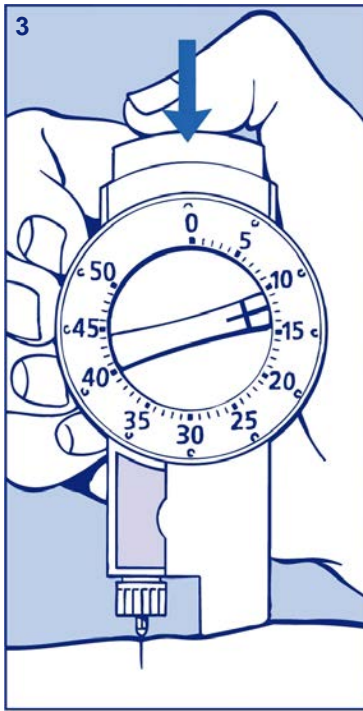

Removing the needle

- **Replace the big outer needle cap and unscrew the needle (picture 4). Dispose of it carefully.**
- Put the pen cap back on your InnoLet to protect the insulin from light.

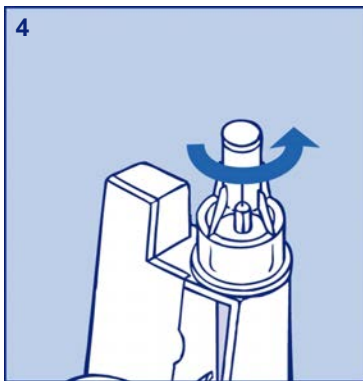

Always use a new needle for each injection. Always remove and discard the needle after each injection and store your InnoLet without the needle attached. This reduces the risk of contamination, infection, leakage of insulin, blocked needles and inaccurate dosing.

Further important information

Caregivers must be very careful when handling used needles – to reduce the risk of needle sticks and cross-infection.

Dispose of your used InnoLet carefully without the needle attached.

Never share your pen or your needles with other people. It might lead to cross-infection.

Never share your pen with other people. Your medicine might be harmful to their health.

Always keep your InnoLet and needles out of sight and reach of others, especially children.

Caring for your pen

Your InnoLet is designed to work accurately and safely. It must be handled with care. If it is dropped, damaged or crushed, there is a risk of insulin leakage. This may cause inaccurate dosing, which can lead to too high or too low blood sugar level.

You can clean your InnoLet by wiping it with a medicinal swab. Do not soak, wash or lubricate it. This may damage the mechanism and may cause inaccurate dosing, which can lead to too high or too low blood sugar level.

Do not refill your InnoLet. Once empty, it must be disposed of.

Package leaflet: Information for the user

NovoRapid FlexTouch 100 units/ml solution for injection in pre-filled pen insulin aspart

Read all of this leaflet carefully before you start using this medicine because it contains important information for you.

- Keep this leaflet. You may need to read it again.
- If you have any further questions, ask your doctor, nurse or pharmacist.
- This medicine has been prescribed for you only. Do not pass it on to others. It may harm them, even if their signs of illness are the same as yours.
- If you get any side effects, talk with your doctor, nurse or pharmacist. This includes any possible side effects not listed in this leaflet. See section 4.

What is in this leaflet

1. What NovoRapid is and what it is used for
2. What you need to know before you use NovoRapid
3. How to use NovoRapid
4. Possible side effects
5. How to store NovoRapid
6. Contents of the pack and other information

1. What NovoRapid is and what it is used for

NovoRapid is a modern insulin (insulin analogue) with a rapid-acting effect. Modern insulin products are improved versions of human insulin.

NovoRapid is used to reduce the high blood sugar level in adults, adolescents and children aged 1 year and above with diabetes mellitus (diabetes). Diabetes is a disease where your body does not produce enough insulin to control the level of your blood sugar. Treatment with NovoRapid helps to prevent complications from your diabetes.

NovoRapid will start to lower your blood sugar 10–20 minutes after you inject it, a maximum effect occurs between 1 and 3 hours after the injection and the effect lasts for 3–5 hours. Due to this short action NovoRapid should normally be taken in combination with intermediate-acting or long-acting insulin preparations.

2. What you need to know before you use NovoRapid

Do not use NovoRapid

- ▶ If you are allergic to insulin aspart, or any of the other ingredients in this medicine (see section 6, Contents of the pack and other information).
- ▶ If you suspect hypoglycaemia (low blood sugar) is starting (see a) Summary of serious and very common side effects in section 4).
- ▶ If FlexTouch is dropped, damaged or crushed.
- ▶ If it has not been stored correctly or been frozen (see section 5, How to store NovoRapid).
- ▶ If the insulin does not appear clear and colourless.

If any of these applies, do not use NovoRapid. Talk with your doctor, nurse or pharmacist for advice.

Before using NovoRapid

- ▶ Check the label to make sure it is the right type of insulin.
- ▶ Always use a new needle for each injection to prevent contamination.
- ▶ Needles and NovoRapid FlexTouch must not be shared.
- ▶ NovoRapid FlexTouch is only suitable for injecting under the skin. Speak to your doctor if you need to inject your insulin by another method.

Warnings and precautions

Some conditions and activities can affect your need for insulin. Consult your doctor:

- ▶ If you have trouble with your kidneys or liver, or with your adrenal, pituitary or thyroid glands.
- ▶ If you exercise more than usual or if you want to change your usual diet, as this may affect your blood sugar level.
- ▶ If you are ill, carry on taking your insulin and consult your doctor.
- ▶ If you are going abroad, travelling over time zones may affect your insulin needs and the timing of your injections.

Skin changes at the injection site

The injection site should be rotated to help prevent changes to the fatty tissue under the skin, such as skin thickening, skin shrinking or lumps under the skin. The insulin may not work very well if you inject into a lumpy, shrunken or thickened area (see section 3, How to use NovoRapid). Tell your doctor if you notice any skin changes at the injection site. Tell your doctor if you are currently injecting into these affected areas before you start injecting in a different area. Your doctor may tell you to check your blood sugar more closely, and to adjust your insulin or your other antidiabetic medications dose.

Children and adolescents

Do not give this medicine to children below 1 year of age since no clinical studies have been carried out in children below the age of 1 year.

Other medicines and NovoRapid

Tell your doctor, nurse or pharmacist if you are taking, have recently taken or might take any other medicines.

Some medicines affect your blood sugar level and this may mean that your insulin dose has to change. Listed below are the most common medicines which may affect your insulin treatment.

Your blood sugar level may fall (hypoglycaemia) if you take:

- Other medicines for the treatment of diabetes
- Monoamine oxidase inhibitors (MAOI) (used to treat depression)
- Beta-blockers (used to treat high blood pressure)
- Angiotensin converting enzyme (ACE) inhibitors (used to treat certain heart conditions or high blood pressure)
- Salicylates (used to relieve pain and lower fever)
- Anabolic steroids (such as testosterone)
- Sulphonamides (used to treat infections).

Your blood sugar level may rise (hyperglycaemia) if you take:

- Oral contraceptives (birth control pills)
- Thiazides (used to treat high blood pressure or excessive fluid retention)
- Glucocorticoids (such as 'cortisone' used to treat inflammation)
- Thyroid hormones (used to treat thyroid gland disorders)
- Sympathomimetics (such as epinephrine [adrenaline], or salbutamol, terbutaline used to treat asthma)

- Growth hormone (medicine for stimulation of skeletal and somatic growth and pronounced influence on the body's metabolic processes)
- Danazol (medicine acting on ovulation).

Octreotide and lanreotide (used for treatment of acromegaly, a rare hormonal disorder that usually occurs in middle-aged adults, caused by the pituitary gland producing excess growth hormone) may either increase or decrease your blood sugar level.

Beta-blockers (used to treat high blood pressure) may weaken or suppress entirely the first warning symptoms which help you to recognise low blood sugar.

Pioglitazone (tablets used for the treatment of type 2 diabetes)

Some patients with long-standing type 2 diabetes and heart disease or previous stroke who were treated with pioglitazone and insulin experienced the development of heart failure. Inform your doctor as soon as possible if you experience signs of heart failure such as unusual shortness of breath or rapid increase in weight or localised swelling (oedema).

If you have taken any of the medicines listed here, tell your doctor, nurse or pharmacist.

Drinking alcohol and taking NovoRapid

- ▶ If you drink alcohol, your need for insulin may change as your blood sugar level may either rise or fall. Careful monitoring is recommended.

Pregnancy and breast-feeding

- ▶ If you are pregnant, think you may be pregnant or are planning to have a baby, ask your doctor for advice before taking this medicine. NovoRapid can be used during pregnancy. Your insulin dose may need to be changed during pregnancy and after delivery. Careful control of your diabetes, particularly prevention of hypoglycaemia, is important for the health of your baby.
- ▶ There are no restrictions on treatment with NovoRapid during breast-feeding.

Ask your doctor, nurse or pharmacist for advice before taking this medicine while pregnant or breast-feeding.

Driving and using machines

- ▶ Please ask your doctor whether you can drive a car or operate a machine:
 - If you have frequent hypoglycaemia.
 - If you find it hard to recognise hypoglycaemia.

If your blood sugar is low or high, your concentration and ability to react might be affected and therefore also your ability to drive or operate a machine. Bear in mind that you could endanger yourself or others.

NovoRapid has a rapid onset of effect therefore if hypoglycaemia occurs, you may experience it earlier after an injection when compared to soluble human insulin.

Important information about some of the ingredients of NovoRapid

NovoRapid contains less than 1 mmol sodium (23 mg) per dose, i.e. NovoRapid is essentially 'sodium-free'.

3. How to use NovoRapid

Dose and when to take your insulin

Always use your insulin and adjust your dose exactly as your doctor has told you. Check with your doctor, nurse or pharmacist if you are not sure.

NovoRapid is generally taken immediately before a meal. Eat a meal or snack within 10 minutes of the injection to avoid low blood sugar. When necessary, NovoRapid can be given soon after a meal. See How and where to inject below for information.

Do not change your insulin unless your doctor tells you to. If your doctor has switched you from one type or brand of insulin to another, your dose may have to be adjusted by your doctor.

Use in children and adolescents

NovoRapid can be used in adolescents and children aged 1 year and above instead of soluble human insulin when a rapid onset of effect is preferred. For example, when it is difficult to dose the child in relation to meals.

Use in special patient groups

If you have reduced kidney or liver function, or if you are above 65 years of age, you need to check your blood sugar more regularly and discuss changes in your insulin dose with your doctor.

How and where to inject

NovoRapid is for injection under the skin (subcutaneously). You must never inject yourself directly into a vein (intravenously) or muscle (intramuscularly). NovoRapid FlexTouch is only suitable for injecting under the skin. Speak to your doctor if you need to inject your insulin by another method.

With each injection, change the injection site within the particular area of skin that you use. This may reduce the risk of developing lumps or skin pitting (see section 4, Possible side effects). The best places to give yourself an injection are: the front of your waist (abdomen), the upper arm or the front of your thighs. The insulin will work more quickly if injected into the front of your waist. You should always measure your blood sugar regularly.

How to handle NovoRapid FlexTouch

NovoRapid FlexTouch is a pre-filled, colour-coded, disposable pen containing insulin aspart.

Read carefully the instructions on how to use NovoRapid FlexTouch included in this package leaflet. You must use the pen as described in the instructions on how to use NovoRapid FlexTouch.

Always ensure you use the correct pen before you inject your insulin.

If you take more insulin than you should

If you take too much insulin your blood sugar gets too low (hypoglycaemia). See a) Summary of serious and very common side effects in section 4.

If you forget to take your insulin

If you forget to take your insulin your blood sugar may get too high (hyperglycaemia). See c) Effects from diabetes in section 4.

If you stop taking your insulin

Do not stop taking your insulin without speaking with a doctor, who will tell you what needs to be done. This could lead to very high blood sugar (severe hyperglycaemia) and ketoacidosis. See c) Effects from diabetes in section 4.

If you have any further questions on the use of this medicine, ask your doctor, nurse or pharmacist.

4. Possible side effects

Like all medicines, this medicine can cause side effects, although not everybody gets them.

a) Summary of serious and very common side effects

Low blood sugar (hypoglycaemia) is a very common side effect. It may affect more than 1 in 10 people.

Low blood sugar may occur if you:

- Inject too much insulin.
- Eat too little or miss a meal.
- Exercise more than usual.
- Drink alcohol (see Drinking alcohol and taking NovoRapid in section 2).

Signs of low blood sugar: Cold sweat; cool pale skin; headache; rapid heartbeat; feeling sick; feeling very hungry; temporary changes in vision; drowsiness; unusual tiredness and weakness; nervousness or tremor; feeling anxious; feeling confused; difficulty in concentrating.

Severe low blood sugar can lead to unconsciousness. If prolonged severe low blood sugar is not treated, it can cause brain damage (temporary or permanent) and even death. You may recover more quickly from unconsciousness with an injection of the hormone glucagon by someone who knows how to use it. If you are given glucagon, you will need glucose or a sugar snack as soon as you are conscious. If you do not respond to glucagon treatment, you will have to be treated in a hospital.

What to do if you experience low blood sugar:

- ▶ If you experience low blood sugar, eat glucose tablets or another high sugar snack (e.g. sweets, biscuits, fruit juice). Measure your blood sugar if possible and rest. Always carry glucose tablets or high sugar snacks with you, just in case.
- ▶ When symptoms of low blood sugar have disappeared or when blood sugar level is stabilised, continue insulin treatment as usual.
- ▶ If you have such a low blood sugar that it makes you pass out, if you have had need for injection of glucagon, or if you have experienced many incidents of low blood sugar, talk with a doctor. The amount or timing of insulin, food or exercise may need to be adjusted.

Tell relevant people that you have diabetes and what the consequences may be, including the risk of passing out (become unconscious) due to low blood sugar. Let them know that if you pass out, they must turn you on your side and get medical help straight away. They must not give you any food or drink due to risk of suffocation.

Serious allergic reactions to NovoRapid or one of its ingredients (called a systemic allergic reaction) is a very rare side effect but can potentially be life threatening. It may affect less than 1 in 10,000 people.

Seek medical advice immediately:

- If signs of allergy spread to other parts of your body.
- If you suddenly feel unwell, and you: start sweating; start being sick (vomiting); have difficulty in breathing; have a rapid heartbeat; feel dizzy.
- ▶ If you notice any of these signs, seek medical advice immediately.

Skin changes at the injection site: If you inject insulin at the same place, the fatty tissue may shrink (lipoatrophy) or thicken (lipohypertrophy) (may affect less than 1 in 100 people). Lumps under the skin may also be caused by build-up of a protein called amyloid (cutaneous amyloidosis; how often this occurs is not known). The insulin may not work very well if you inject into a lumpy, shrunken or thickened area. Change the injection site with each injection to help prevent these skin changes.

b) List of other side effects

Uncommon side effects

May affect less than 1 in 100 people.

Signs of allergy: Local allergic reactions (pain, redness, hives, inflammation, bruising, swelling and itching) at the injection site may occur. These usually disappear after a few weeks of taking your insulin. If they do not disappear, or if they spread throughout your body, talk to your doctor immediately. See also Serious allergic reactions above.

Vision problems: When you first start your insulin treatment, it may disturb your vision, but the disturbance is usually temporary.

Swollen joints: When you start taking insulin, water retention may cause swelling around your ankles and other joints. Normally this soon disappears. If not, talk to your doctor.

Diabetic retinopathy (an eye disease related to diabetes which can lead to loss of vision): If you have diabetic retinopathy and your blood sugar level improves very fast, the retinopathy may get worse. Ask your doctor about this.

Rare side effects

May affect less than 1 in 1,000 people.

Painful neuropathy (pain due to nerve damage): If your blood sugar level improves very fast, you may get nerve related pain. This is called acute painful neuropathy and is usually transient.

Reporting of side effects

If you get any side effects, talk with your doctor, nurse or pharmacist. This includes any possible side effects not listed in this leaflet. You can also report side effects directly via **the national reporting system listed in [Appendix V](#)**. By reporting side effects you can help provide more information on the safety of this medicine.

c) Effects from diabetes

High blood sugar (hyperglycaemia)

High blood sugar may occur if you:

- Have not injected enough insulin.
- Forget to inject your insulin or stop taking insulin.
- Repeatedly inject less insulin than you need.
- Get an infection and/or a fever.
- Eat more than usual.
- Exercise less than usual.

Warning signs of high blood sugar:

The warning signs appear gradually. They include: increased urination; feeling thirsty; losing your appetite; feeling sick (nausea or vomiting); feeling drowsy or tired; flushed; dry skin; dry mouth and a fruity (acetone) smell of the breath.

What to do if you experience high blood sugar:

- ▶ If you get any of the above signs: test your blood sugar level, test your urine for ketones if you can, then seek medical advice immediately.
- ▶ These may be signs of a very serious condition called diabetic ketoacidosis (build-up of acid in the blood because the body is breaking down fat instead of sugar). If you do not treat it, this could lead to diabetic coma and eventually death.

5. How to store NovoRapid

Keep this medicine out of the sight and reach of children.

Do not use this medicine after the expiry date which is stated on the FlexTouch label and carton, after 'EXP'. The expiry date refers to the last day of that month.

Always keep the pen cap on your FlexTouch when you are not using it in order to protect it from light. NovoRapid must be protected from excessive heat and light.

Before opening: NovoRapid FlexTouch that is not being used is to be stored in the refrigerator at 2°C to 8°C, away from the cooling element. Do not freeze.

During use or when carried as a spare: You can carry your NovoRapid FlexTouch with you and keep it at a temperature below 30°C or in a refrigerator (2°C to 8°C) for up to 4 weeks. If refrigerated, keep away from the cooling element. Do not freeze.

Do not throw away any medicines via wastewater or household waste. Ask your pharmacist how to throw away medicines you no longer use. These measures will help protect the environment.

6. Contents of the pack and other information

What NovoRapid contains

- The active substance is insulin aspart. Each ml contains 100 units of insulin aspart. Each pre-filled pen contains 300 units of insulin aspart in 3 ml solution for injection.
- The other ingredients are glycerol, phenol, metacresol, zinc chloride, disodium phosphate dihydrate, sodium chloride, hydrochloric acid, sodium hydroxide and water for injections.

What NovoRapid looks like and contents of the pack

NovoRapid is presented as a solution for injection.

Pack sizes of 1 (with or without needles) or 5 (without needles) or a multipack with 2 x 5 (without needles) pre-filled pens of 3 ml. Not all pack sizes may be marketed.

The solution is clear and colourless.

Marketing Authorisation Holder and Manufacturer

Novo Nordisk A/S, Novo Allé, DK-2880 Bagsværd, Denmark

Now turn over for information on how to use your FlexTouch.

This leaflet was last revised in

Other sources of information

Detailed information on this medicine is available on the European Medicines Agency website:
<http://www.ema.europa.eu>.

Instructions on how to use NovoRapid 100 units/ml solution for injection in pre-filled pen (FlexTouch)

Please read these instructions carefully before using your FlexTouch pre-filled pen. If you do not follow the instructions carefully, you may get too little or too much insulin, which can lead to too high or too low blood sugar level.

Do not use the pen without proper training from your doctor or nurse.

Start by checking your pen to **make sure that it contains NovoRapid 100 units/ml**, then look at the illustrations to the right to get to know the different parts of your pen and needle.

If you are blind or have poor eyesight and cannot read the dose counter on the pen, do not use this pen without help. Get help from a person with good eyesight who is trained to use the FlexTouch pre-filled pen.

Your NovoRapid FlexTouch pen is a pre-filled insulin pen. NovoRapid FlexTouch contains 300 units of insulin and delivers doses from 1 to 80 units, in increments of 1 unit.

NovoRapid FlexTouch is designed to be used with **NovoFine or NovoTwist** single-use disposable needles up to a length of 8 mm.

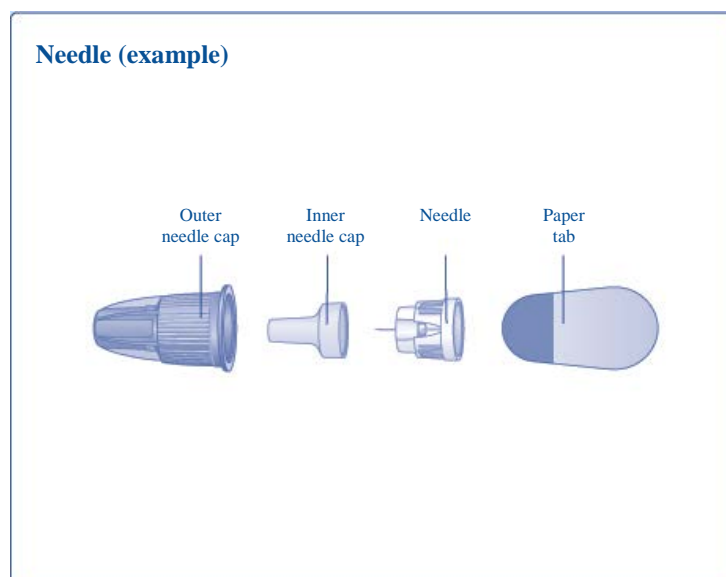
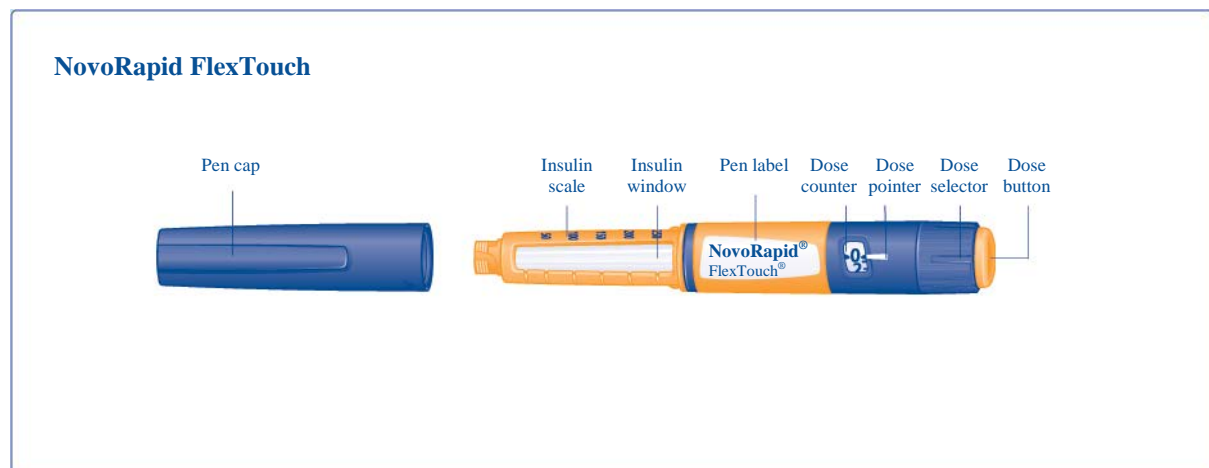

Preparing your NovoRapid FlexTouch pen

Check the name and coloured label on your NovoRapid FlexTouch pen to make sure that it contains the type of insulin you need. This is especially important if you take more than one type of

insulin. If you take a wrong type of insulin, your blood sugar level may get too high or too low.

- A** Pull off the pen cap.

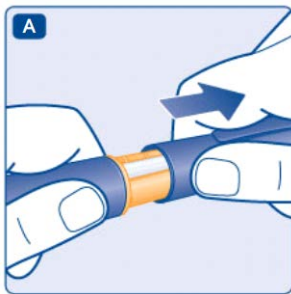

- B** Check that the insulin in your pen is clear and colourless. Look through the insulin window. If the insulin looks cloudy, do not use the pen.

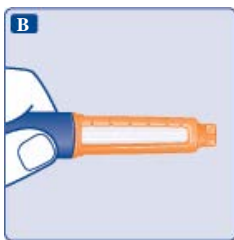

- C** Take a new disposable needle, and tear off the paper tab.

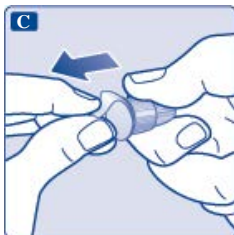

- D** Screw the needle straight onto the pen. Make sure the needle is on tight.

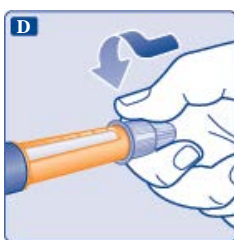

- E** Pull off the outer needle cap and save it. You will need it after the injection to correctly remove the needle from the pen.

Pull off the inner needle cap and throw it away. If you try to put it back on, you may accidentally stick yourself with the needle.

A drop of insulin may appear at the needle tip. This is normal.

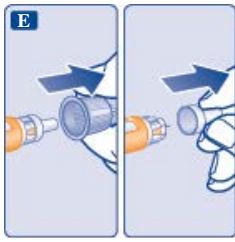

- ⚠ **Always use a new needle for each injection.** This reduces the risk of contamination, infection, leakage of insulin, blocked needles and inaccurate dosing.
- ⚠ **Never use a bent or damaged needle.**

Checking the insulin flow

Make sure that you receive your full dose by always checking the insulin flow before you select and inject your dose.

- F** Turn the dose selector to select 2 units.



- G** Hold the pen with the needle pointing up.

Tap the top of the pen a few times to let any air bubbles rise to the top.



- H** Press the dose button with your thumb until the dose counter returns to 0. The 0 must line up with the dose pointer. A drop of insulin will appear at the needle tip.

If no drop appears, repeat steps **F** to **H** up to 6 times. If no drop appears after these new attempts, change the needle and repeat steps **F** to **H** once more.

Do not use the pen if a drop of insulin still does not appear.

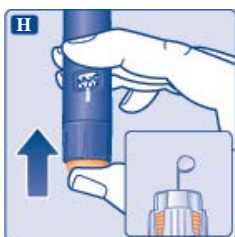

- ⚠ **Always make sure that a drop appears** at the needle tip before you inject. This makes sure that the insulin flows. If no drop appears, you will **not** inject any insulin, even though the dose counter may move. This may indicate a blocked or damaged needle.
- ⚠ **Always check the flow before you inject.** If you do not check the flow, you may get too little insulin or no insulin at all. This may lead to too high blood sugar level.

Selecting your dose

Use the dose selector on your NovoRapid FlexTouch pen to select your dose. You can select up to 80 units per dose.

- I Select the dose you need. You can turn the dose selector forwards or backwards. Stop when the right number of units lines up with the dose pointer.

The dose selector clicks differently when turned forwards, backwards or past the number of units left.

When the pen contains less than 80 units, the dose counter stops at the number of units left.



- ⚠ **Always use the dose counter and the dose pointer to see how many units you have selected before injecting the insulin.**

Do not count the pen clicks. If you select and inject the wrong dose, your blood sugar level may get too high or too low.

Do not use the insulin scale, it only shows approximately how much insulin is left in your pen.

- ⓘ **How much insulin is left?**

The **insulin scale** shows you **approximately** how much insulin is left in your pen.



To see precisely how much insulin is left, use the dose counter:

Turn the dose selector until the **dose counter stops**. If it shows 80, **at least 80** units are left in your pen. If it shows **less than 80**, the number shown is the number of units left in your pen.

Turn the dose selector back until the dose counter shows 0.

If you need more insulin than the units left in your pen, you can split your dose between two pens.

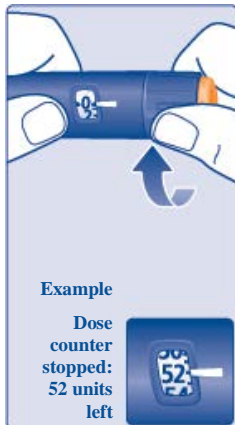

▲ Be very careful to calculate correctly if splitting your dose.

If in doubt, take the full dose with a new pen. If you split the dose wrong, you will inject too little or too much insulin, which can lead to too high or too low blood sugar level.

Injecting your dose

Make sure that you receive your full dose by using the right injection technique.

J Insert the needle into your skin as your doctor or nurse has shown you. Make sure you can see the dose counter. Do not touch the dose counter with your fingers. This could interrupt the injection.

Press the dose button until the dose counter returns to 0. The 0 must line up with the dose pointer. You may then hear or feel a click.

After the dose counter has returned to 0, leave the needle under the skin for **at least 6 seconds** to make sure that you get your full dose.



K Remove the needle from the skin.

After that, you may see a drop of insulin at the needle tip. This is normal and has no effect on the dose you just received.

- i** **Always dispose of the needle after each injection.** This reduces the risk of contamination, infection, leakage of insulin, blocked needles and inaccurate dosing. If the needle is blocked, you will **not** inject any insulin.

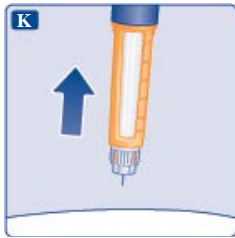

- L** Lead the needle tip into the outer needle cap on a flat surface. Do not touch the needle or the cap.

Once the needle is covered, carefully push the outer needle cap completely on and then unscrew the needle. Dispose of it carefully, and put the pen cap back on after every use.

When the pen is empty, throw it away without a needle on as instructed by your doctor, nurse or local authorities.



- ▲** **Always watch the dose counter to know how many units you inject.**
The dose counter will show the exact number of units. Do not count the pen clicks. Hold the dose button down until the dose counter returns to 0 after the injection. If the dose counter stops before it returns to 0, the full dose has not been delivered, which may result in too high blood sugar level.
- ▲** **Never try to put the inner needle cap back on the needle.** You may stick yourself with the needle.
- ▲** **Always remove the needle after each injection** and store your pen without the needle attached. This reduces the risk of contamination, infection, leakage of insulin, blocked needles and inaccurate dosing.

Caring for your pen

Treat your pen with care. Rough handling or misuse may cause inaccurate dosing, which can lead to too high or too low blood sugar level.

- **Do not leave the pen in a car** or other place where it can get too hot or too cold.
- **Do not expose your pen to dust, dirt or liquid.**
- **Do not wash, soak or lubricate your pen.** If necessary, clean it with mild detergent on a moistened cloth.
- **Do not drop your pen** or knock it against hard surfaces.
If you drop it or suspect a problem, attach a new needle and check the insulin flow before you

inject.

- **Do not try to refill your pen.** Once empty, it must be disposed of.
- **Do not try to repair your pen** or pull it apart.



Important information

- **Always keep your pen with you.**
- **Always carry an extra pen and new needles** with you, in case of loss or damage.
- Always keep your pen and needles **out of sight and reach of others**, especially children.
- **Never share** your pen or your needles with other people. It might lead to cross-infection.
- **Never share** your pen with other people. Your medicine might be harmful to their health.
- Caregivers must **be very careful when handling used needles** – to reduce the risk of needle injury and cross-infection.

Package leaflet: Information for the user

NovoRapid PumpCart 100 units/ml solution for injection in cartridge insulin aspart

Read all of this leaflet carefully before you start using this medicine because it contains important information for you.

- Keep this leaflet. You may need to read it again.
- If you have any further questions, ask your doctor, nurse or pharmacist.
- This medicine has been prescribed for you only. Do not pass it on to others. It may harm them, even if their signs of illness are the same as yours.
- If you get any side effects, talk with your doctor, nurse or pharmacist. This includes any possible side effects not listed in this leaflet. See section 4.

What is in this leaflet

1. What NovoRapid PumpCart is and what it is used for
2. What you need to know before you use NovoRapid PumpCart
3. How to use NovoRapid PumpCart
4. Possible side effects
5. How to store NovoRapid PumpCart
6. Contents of the pack and other information

1. What NovoRapid PumpCart is and what it is used for

NovoRapid is a modern insulin (insulin analogue) with a rapid-acting effect. Modern insulin products are improved versions of human insulin.

NovoRapid is used to reduce the high blood sugar level in adults, adolescents and children aged 1 year and above with diabetes mellitus (diabetes). Diabetes is a disease where your body does not produce enough insulin to control the level of your blood sugar. Treatment with NovoRapid helps to prevent complications from your diabetes.

NovoRapid PumpCart is for use in a pump and covers your total daily insulin needs: both your all day (basal) and meal-time (bolus) insulin needs. Before you use NovoRapid PumpCart in the pump you must have received a comprehensive instruction by your doctor or nurse.

Basal (all-day) insulin requirements: When you use NovoRapid PumpCart in a pump, your insulin will be constantly delivered to cover your basal need for insulin. If you change the basal insulin setting the change will start to affect you within 10–20 minutes. If you stop the pump, the insulin effect will last for 3 to 5 hours. Before you set or change the basal rate, carefully read the pump manual (user guide).

Bolus (meal-time) insulin requirements: NovoRapid will start to lower your blood sugar within 10–20 minutes after you start a bolus delivery (see section 3, How to use NovoRapid PumpCart, for more information about how to adjust your bolus dose). The maximum effect occurs between 1 and 3 hours after the bolus delivery and the effect lasts for 3 to 5 hours.

2. What you need to know before you use NovoRapid PumpCart

Do not use NovoRapid PumpCart

- ▶ If you are allergic to insulin aspart, or any of the other ingredients in this medicine (see section 6, Contents of the pack and other information).
- ▶ If you suspect hypoglycaemia (low blood sugar) is starting (see a) Summary of serious and very common side effects in section 4).
- ▶ If the cartridge or the device containing the cartridge is dropped, damaged or crushed.
- ▶ If it has not been stored correctly or been frozen (see section 5, How to store NovoRapid PumpCart).
- ▶ If the insulin does not appear clear and colourless.

If any of these applies, do not use NovoRapid PumpCart. Talk with your doctor, nurse or pharmacist for advice.

Before using NovoRapid PumpCart

- ▶ Check the label to make sure it is the right type of insulin.
- ▶ Always check the cartridge, including the rubber plunger at the bottom of the cartridge. Do not use it if any damage or leakage is seen or if the rubber plunger has been drawn above the white label band at the bottom of the cartridge. This could be a result of leakage of insulin. If you suspect the cartridge is damaged, take it back to your supplier.
- ▶ Infusion sets (tubing and needle) and NovoRapid PumpCart must not be shared.
- ▶ NovoRapid PumpCart is only suitable for injecting under the skin (subcutaneously) using a pump. Speak to your doctor if you need to inject your insulin by another method.

Warnings and precautions

Some conditions and activities can affect your need for insulin. Consult your doctor:

- ▶ If you have trouble with your kidneys or liver, or with your adrenal, pituitary or thyroid glands.
- ▶ If you exercise more than usual or if you want to change your usual diet, as this may affect your blood sugar level.
- ▶ If you are ill, carry on taking your insulin and consult your doctor.
- ▶ If you are going abroad, travelling over time zones may affect your insulin needs and the timing of your injections.

Skin changes at the injection site

The injection site should be rotated to help prevent changes to the fatty tissue under the skin, such as skin thickening, skin shrinking or lumps under the skin. The insulin may not work very well if you inject into a lumpy, shrunken or thickened area (see section 3, How to use NovoRapid). Tell your doctor if you notice any skin changes at the injection site. Tell your doctor if you are currently injecting into these affected areas before you start injecting in a different area. Your doctor may tell you to check your blood sugar more closely, and to adjust your insulin or your other antidiabetic medications dose.

Children and adolescents

Do not give this medicine to children below 1 year of age since no clinical studies have been carried out in children below the age of 1 year.

Other medicines and NovoRapid PumpCart

Tell your doctor, nurse or pharmacist if you are taking, have recently taken or might take any other medicines.

Some medicines affect your blood sugar level and this may mean that your insulin dose has to change. Listed below are the most common medicines which may affect your insulin treatment.

Your blood sugar level may fall (hypoglycaemia) if you take:

- Other medicines for the treatment of diabetes
- Monoamine oxidase inhibitors (MAOI) (used to treat depression)
- Beta-blockers (used to treat high blood pressure)
- Angiotensin converting enzyme (ACE) inhibitors (used to treat certain heart conditions or high blood pressure)
- Salicylates (used to relieve pain and lower fever)
- Anabolic steroids (such as testosterone)
- Sulphonamides (used to treat infections).

Your blood sugar level may rise (hyperglycaemia) if you take:

- Oral contraceptives (birth control pills)
- Thiazides (used to treat high blood pressure or excessive fluid retention)
- Glucocorticoids (such as 'cortisone' used to treat inflammation)
- Thyroid hormones (used to treat thyroid gland disorders)
- Sympathomimetics (such as epinephrine [adrenaline], or salbutamol, terbutaline used to treat asthma)
- Growth hormone (medicine for stimulation of skeletal and somatic growth and pronounced influence on the body's metabolic processes)
- Danazol (medicine acting on ovulation).

Octreotide and lanreotide (used for treatment of acromegaly, a rare hormonal disorder that usually occurs in middle-aged adults, caused by the pituitary gland producing excess growth hormone) may either increase or decrease your blood sugar level.

Beta-blockers (used to treat high blood pressure) may weaken or suppress entirely the first warning symptoms which help you to recognise low blood sugar.

Pioglitazone (tablets used for the treatment of type 2 diabetes)

Some patients with long-standing type 2 diabetes and heart disease or previous stroke who were treated with pioglitazone and insulin experienced the development of heart failure. Inform your doctor as soon as possible if you experience signs of heart failure such as unusual shortness of breath or rapid increase in weight or localised swelling (oedema).

If you have taken any of the medicines listed here, tell your doctor, nurse or pharmacist.

Drinking alcohol and taking NovoRapid

- ▶ If you drink alcohol, your need for insulin may change as your blood sugar level may either rise or fall. Careful monitoring is recommended.

Pregnancy and breast-feeding

- ▶ If you are pregnant, think you may be pregnant or are planning to have a baby, ask your doctor for advice before taking this medicine. NovoRapid can be used during pregnancy. Your insulin dose may need to be changed during pregnancy and after delivery. Careful control of your diabetes, particularly prevention of hypoglycaemia, is important for the health of your baby.
- ▶ There are no restrictions on treatment with NovoRapid during breast-feeding.

Ask your doctor, nurse or pharmacist for advice before taking this medicine while pregnant or breast-feeding.

Driving and using machines

- ▶ Please ask your doctor whether you can drive a car or operate a machine:
- If you have frequent hypoglycaemia.
- If you find it hard to recognise hypoglycaemia.

If your blood sugar is low or high, your concentration and ability to react might be affected and therefore also your ability to drive or operate a machine. Bear in mind that you could endanger yourself or others.

Important information about some of the ingredients of NovoRapid

NovoRapid contains less than 1 mmol sodium (23 mg) per dose, i.e. NovoRapid is essentially 'sodium-free'.

3. How to use NovoRapid PumpCart

Dose and when to take your insulin

Always use your insulin and adjust your basal (all-day) and bolus (meal time) doses exactly as your doctor has told you. Check with your doctor, nurse or pharmacist if you are not sure. Your bolus (meal-time) insulin needs to be adjusted based on your blood sugar measurement and food intake. Eat a meal or snack within 10 minutes of the bolus dose to avoid low blood sugar. When necessary, you can take the bolus dose just after you have finished eating.

Do not change your insulin unless your doctor tells you to. If your doctor has switched you from one type or brand of insulin to another, your dose may have to be adjusted by your doctor.

Use in children and adolescents

NovoRapid can be used in adolescents and children aged 1 year and above.

Use in special patient groups

If you have reduced kidney or liver function, or if you are above 65 years of age, you need to check your blood sugar more regularly and discuss changes in your insulin dose with your doctor.

How and where to inject

NovoRapid PumpCart is only suitable for injecting under the skin (subcutaneously) using a pump. Never inject directly into a vein (intravenously) or muscle (intramuscularly). Speak to your doctor if you need to inject your insulin by another method.

Before using NovoRapid PumpCart in a pump, you must have thorough training in the use of the pump and information about any actions to be taken in case of illness, too high or too low blood sugar or failure of the pump. Follow your doctor's instructions and advice about the use of NovoRapid PumpCart in the pump.

Normally you will inject your insulin in the front of your waist (abdomen). Alternatively, if your doctor recommends it, you may use your thigh or upper arm. When you change the infusion set (tubing and needle), be sure to change the site for inserting the needle (injection site). This may reduce the risk of developing lumps or skin pitting (see section 4, Possible side effects). Changing the infusion set must be done according to the instructions in the manual supplied with the infusion set.

When you are using an insulin pump

It is best to measure your blood sugar level regularly to get the maximum benefit of insulin delivery, and to make sure the pump is working properly. If you experience any problems contact your doctor.

- ▶ NovoRapid PumpCart is only for use with a pump designed to be used with this cartridge, such as the Accu-Chek Insight and YpsoPump insulin pumps.
- ▶ NovoRapid PumpCart is a pre-filled cartridge ready for use directly in the pump. Follow the pump manual (user guide).
- ▶ To ensure correct dosing, NovoRapid PumpCart must not be used in an insulin pen.
- ▶ NovoRapid should never be mixed with any other medicinal product including other insulin products when used in a pump.
- ▶ Do not refill the cartridge. Once empty, it must be disposed of.
- ▶ Always carry a spare NovoRapid PumpCart.

Read carefully the instructions on how to use NovoRapid PumpCart included in this package leaflet.

What to do in case of pump failure

Make sure you have an alternative delivery method for your insulin available for injection under the skin (for example, a pen injector) in case the pump stops working.

If you take more insulin than you should

If you take too much insulin your blood sugar gets too low (hypoglycaemia). See a) Summary of serious and very common side effects in section 4.

If you forget to take your insulin

If you forget to take your insulin your blood sugar may get too high (hyperglycaemia). See c) Effects from diabetes in section 4.

If you stop taking your insulin

Do not stop taking your insulin without speaking with a doctor, who will tell you what needs to be done. This could lead to very high blood sugar (severe hyperglycaemia) and ketoacidosis. See c) Effects from diabetes in section 4.

If you have any further questions on the use of this medicine, ask your doctor, nurse or pharmacist.

4. Possible side effects

Like all medicines, this medicine can cause side effects, although not everybody gets them.

a) Summary of serious and very common side effects

Low blood sugar (hypoglycaemia) is a very common side effect. It may affect more than 1 in 10 people.

Low blood sugar may occur if you:

- Inject too much insulin.
- Eat too little or miss a meal.
- Exercise more than usual.
- Drink alcohol (see Drinking alcohol and taking NovoRapid in section 2).

Signs of low blood sugar: Cold sweat; cool pale skin; headache; rapid heartbeat; feeling sick; feeling very hungry; temporary changes in vision; drowsiness; unusual tiredness and weakness; nervousness or tremor; feeling anxious; feeling confused; difficulty in concentrating.

Severe low blood sugar can lead to unconsciousness. If prolonged severe low blood sugar is not treated, it can cause brain damage (temporary or permanent) and even death. You may recover more quickly from unconsciousness with an injection of the hormone glucagon by someone who knows how to use it. If you are given glucagon, you will need glucose or a sugar snack as soon as you are conscious. If you do not respond to glucagon treatment, you will have to be treated in a hospital.

What to do if you experience low blood sugar:

- ▶ If you experience low blood sugar, eat glucose tablets or another high sugar snack (e.g. sweets, biscuits, fruit juice) and adjust insulin delivery or stop your pump. Measure your blood sugar if possible and rest. Always carry glucose tablets or high sugar snacks with you, just in case.
- ▶ When symptoms of low blood sugar have disappeared or when blood sugar level is stabilised, continue insulin treatment as usual.
- ▶ If you have such a low blood sugar that it makes you pass out, if you have had need for injection of glucagon, or if you have experienced many incidents of low blood sugar, talk with a doctor. The amount or timing of insulin, food or exercise may need to be adjusted.

Tell relevant people that you have diabetes and what the consequences may be, including the risk of passing out (become unconscious) due to low blood sugar. Let them know that if you pass out, they must turn you on your side and get medical help straight away. They must not give you any food or drink due to risk of suffocation.

Serious allergic reactions to NovoRapid or one of its ingredients (called a systemic allergic reaction) is a very rare side effect but can potentially be life threatening. It may affect less than 1 in 10,000 people.

Seek medical advice immediately:

- If signs of allergy spread to other parts of your body.
- If you suddenly feel unwell, and you: start sweating; start being sick (vomiting); have difficulty in breathing; have a rapid heartbeat; feel dizzy.
- ▶ If you notice any of these signs, seek medical advice immediately.

Skin changes at the injection site: If you inject insulin at the same place, the fatty tissue may shrink (lipoatrophy) or thicken (lipohypertrophy) (may affect less than 1 in 100 people). Lumps under the skin may also be caused by build-up of a protein called amyloid (cutaneous amyloidosis; how often this occurs is not known). The insulin may not work very well if you inject into a lumpy, shrunken or thickened area. Change the injection site with each injection to help prevent these skin changes.

b) List of other side effects

Uncommon side effects

May affect less than 1 in 100 people.

Signs of allergy: Local allergic reactions (pain, redness, hives, inflammation, bruising, swelling and itching) at the injection site may occur. These usually disappear after a few weeks of taking your insulin. If they do not disappear, or if they spread throughout your body, talk to your doctor immediately. See also Serious allergic reactions above.

Vision problems: When you first start your insulin treatment, it may disturb your vision, but the disturbance is usually temporary.

Swollen joints: When you start taking insulin, water retention may cause swelling around your ankles and other joints. Normally this soon disappears. If not, talk to your doctor.

Diabetic retinopathy (an eye disease related to diabetes which can lead to loss of vision): If you have diabetic retinopathy and your blood sugar level improves very fast, the retinopathy may get worse. Ask your doctor about this.

Rare side effects

May affect less than 1 in 1,000 people.

Painful neuropathy (pain due to nerve damage): If your blood sugar level improves very fast, you may get nerve related pain. This is called acute painful neuropathy and is usually transient.

Reporting of side effects

If you get any side effects, talk with your doctor, nurse or pharmacist. This includes any possible side effects not listed in this leaflet. You can also report side effects directly via [the national reporting system listed in Appendix V](#). By reporting side effects you can help provide more information on the safety of this medicine.

c) Effects from diabetes

High blood sugar (hyperglycaemia)

High blood sugar may occur if you:

- Have not injected enough insulin.
- Forget to inject your insulin or stop taking insulin.
- Repeatedly inject less insulin than you need.
- Get an infection and/or a fever.
- Eat more than usual.
- Exercise less than usual.

Warning signs of high blood sugar:

The warning signs appear gradually. They include: increased urination; feeling thirsty; losing your appetite; feeling sick (nausea or vomiting); feeling drowsy or tired; flushed; dry skin; dry mouth and a fruity (acetone) smell of the breath.

What to do if you experience high blood sugar:

- ▶ If you get any of the above signs: test your blood sugar level, test your urine for ketones if you can, then seek medical advice immediately.
- ▶ These may be signs of a very serious condition called diabetic ketoacidosis (build-up of acid in the blood because the body is breaking down fat instead of sugar). If you do not treat it, this could lead to diabetic coma and eventually death.

5. How to store NovoRapid PumpCart

Keep this medicine out of the sight and reach of children.

Do not use this medicine after the expiry date which is stated on the cartridge label and carton, after 'EXP'. The expiry date refers to the last day of that month.

Always keep the cartridge in the outer carton when you are not using it in order to protect it from light. NovoRapid PumpCart must be protected from excessive heat and light during storage and use.

Before opening: NovoRapid PumpCart that is not being used is to be stored in the refrigerator at 2°C to 8°C, away from the cooling element. Do not freeze.

During use or when carried as a spare: NovoRapid PumpCart in use is not to be kept in the refrigerator. NovoRapid PumpCart carried as a spare can be kept for up to 2 weeks below 30°C. Thereafter it can be used for up to 7 days below 37°C in a pump designed to be used with this

cartridge, such as the Accu-Chek Insight and YpsoPump insulin pumps. Keep NovoRapid PumpCart in the blister until use to protect it from damage. Always protect the cartridge from light during use.

Do not throw away any medicines via wastewater or household waste. Ask your pharmacist how to throw away medicines you no longer use. These measures will help protect the environment.

6. Contents of the pack and other information

What NovoRapid PumpCart contains

- The active substance is insulin aspart. Each ml contains 100 units of insulin aspart. Each cartridge contains 160 units of insulin aspart in 1.6 ml solution for injection.
- The other ingredients are glycerol, phenol, metacresol, zinc chloride, disodium phosphate dihydrate, sodium chloride, hydrochloric acid, sodium hydroxide and water for injections.

What NovoRapid PumpCart looks like and contents of the pack

NovoRapid PumpCart is presented as a solution for injection.

Pack size of 5 cartridges and a multipack containing 25 (5 packs of 5) cartridges of 1.6 ml. Not all pack sizes may be marketed.

The solution is clear and colourless.

Marketing Authorisation Holder and Manufacturer

Novo Nordisk A/S, Novo Allé, DK-2880 Bagsværd, Denmark

Please proceed to the information in ‘Instructions on how to use NovoRapid PumpCart pre-filled cartridge’.

This leaflet was last revised in

Other sources of information

Detailed information on this medicine is available on the European Medicines Agency website: <http://www.ema.europa.eu>.

Instructions on how to use NovoRapid PumpCart pre-filled cartridge.

NovoRapid PumpCart is only for use with an insulin infusion pump system designed to be used with this cartridge, such as the Accu-Chek Insight and YpsoPump insulin pumps. It must not be used with other devices not designed for NovoRapid PumpCart, as this may result in incorrect insulin dosing and subsequent hyper- or hypoglycaemia.

Please read these instructions carefully before using your NovoRapid PumpCart.

Please also read the pump manual (user guide) that comes with your insulin pump.



Pay special attention to these notes as they are important for safe use of NovoRapid PumpCart.

- Treat the pump and cartridge with care and carefully follow the instructions. Rough handling or misuse may cause inaccurate dosing and may lead to too high or too low blood sugar level.
- NovoRapid PumpCart is ready for use directly in the pump.
- NovoRapid PumpCart contains 1.6 ml insulin aspart solution, equivalent to 160 units.
- This medicinal product should never be mixed with any other medicinal products.
- Do not refill NovoRapid PumpCart. Once empty, it must be disposed of.
- Always make sure you have a spare NovoRapid PumpCart available.
- To ensure correct dosing, NovoRapid PumpCart must not be used in an insulin pen.
- NovoRapid PumpCart must be protected from excessive heat and light during storage and use.
- NovoRapid PumpCart should be kept out of reach of others, especially children.

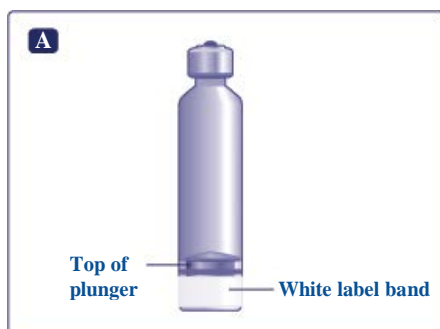

1. Before inserting a NovoRapid PumpCart cartridge into your pump

- Bring NovoRapid PumpCart to room temperature.
- Take NovoRapid PumpCart out of its blister package.
- Check the label to make sure that it is NovoRapid PumpCart.
- Check the expiry date, which is stated on the label and the carton.



Always check that NovoRapid PumpCart looks the way it should. See picture A.

Only the top of the plunger should be seen above the white label band. If you suspect NovoRapid PumpCart is damaged, take it back to your supplier.

Do not use it if any damage or leakage is seen or if the plunger has moved, making the bottom of the plunger visible above the white label band. This could be a result of leakage of insulin.



Check that the insulin in NovoRapid PumpCart is clear and colourless. If the insulin looks cloudy, do not use NovoRapid PumpCart. The cartridge may contain a minor amount of air in the form of small bubbles.

2. Inserting a new NovoRapid PumpCart cartridge in your pump

- Follow the instructions in the pump manual that comes with your pump to insert a new NovoRapid PumpCart cartridge in your pump.
- Insert NovoRapid PumpCart in the cartridge compartment of the pump. The plunger goes in first.
- Connect the infusion set with NovoRapid PumpCart by attaching the adapter onto your pump.



Check the pump and cartridge regularly for damages, for example cracks or leakage. If you smell insulin this could also indicate a leakage. **Do not use** the cartridge if cracks or leakage are seen. Follow the instructions in the pump manual for replacing a cartridge and for cleaning the cartridge compartment in the pump. Insulin leakage can cause inaccurate dosing and may lead to high blood sugar level. See section 4 c) of the package leaflet.



During the day and before going to sleep carefully check that your pump is delivering insulin and there are no leakages. Failure of delivery of your insulin **may not** result in an alert notification from the pump and you may be unaware that there is a problem. You may need to check your blood sugar levels. Tell your doctor or diabetes care team if you suspect a problem with your insulin delivery.

Always make sure you have an alternative delivery method for your insulin available (for example, a pen injector) in case the pump stops working. **Seek medical advice if you think you may have very high blood sugar or diabetic ketoacidosis**

3. Removing an empty NovoRapid PumpCart cartridge from your pump

- Follow the instructions in the pump manual to remove an empty NovoRapid PumpCart cartridge from your pump.
- Remove the infusion set adapter from the empty NovoRapid PumpCart cartridge.
- Dispose of the empty NovoRapid PumpCart cartridge and the used infusion set as instructed by your doctor or nurse.
- Follow the steps described in section 1 and 2 to prepare and insert a new NovoRapid PumpCart into your pump.