

**ANNEX I**  
**SUMMARY OF PRODUCT CHARACTERISTICS**

## 1. NAME OF THE MEDICINAL PRODUCT

Noxafil 40 mg/mL oral suspension

## 2. QUALITATIVE AND QUANTITATIVE COMPOSITION

Each mL of oral suspension contains 40 mg of posaconazole.

### Excipients with known effect

This medicinal product contains approximately 1.75 g of glucose per 5 mL of suspension.

This medicinal product contains 10 mg of sodium benzoate (E211) per 5 mL of suspension.

This medicinal product contains up to 1.25 mg of benzyl alcohol per 5 mL of suspension.

This medicinal product contains up to 24.75 mg of propylene glycol (E1520) per 5 mL of suspension.

For the full list of excipients, see section 6.1.

## 3. PHARMACEUTICAL FORM

Oral suspension

White suspension

## 4. CLINICAL PARTICULARS

### 4.1 Therapeutic indications

Noxafil oral suspension is indicated for use in the treatment of the following fungal infections in adults (see section 5.1):

- Invasive aspergillosis in patients with disease that is refractory to amphotericin B or itraconazole or in patients who are intolerant of these medicinal products;
- Fusariosis in patients with disease that is refractory to amphotericin B or in patients who are intolerant of amphotericin B;
- Chromoblastomycosis and mycetoma in patients with disease that is refractory to itraconazole or in patients who are intolerant of itraconazole;
- Coccidioidomycosis in patients with disease that is refractory to amphotericin B, itraconazole or fluconazole or in patients who are intolerant of these medicinal products;
- Oropharyngeal candidiasis: as first-line therapy in patients who have severe disease or are immunocompromised, in whom response to topical therapy is expected to be poor.

Refractoriness is defined as progression of infection or failure to improve after a minimum of 7 days of prior therapeutic doses of effective antifungal therapy.

Noxafil oral suspension is also indicated for prophylaxis of invasive fungal infections in the following patients:

- Patients receiving remission-induction chemotherapy for acute myelogenous leukaemia (AML) or myelodysplastic syndromes (MDS) expected to result in prolonged neutropenia and who are at high-risk of developing invasive fungal infections;
- Hematopoietic stem cell transplant (HSCT) recipients who are undergoing high-dose immunosuppressive therapy for graft versus host disease and who are at high-risk of developing invasive fungal infections.

Please refer to the Summary of Product Characteristics of Noxafil concentrate for solution for infusion and the gastro-resistant tablets for use in primary treatment of invasive aspergillosis.

## 4.2 Posology and method of administration

Treatment should be initiated by a physician experienced in the management of fungal infections or in the supportive care of high-risk patients for which posaconazole is indicated as prophylaxis.

### **Non-interchangeability between Noxafil oral suspension and Noxafil tablets or Noxafil gastro-resistant powder and solvent for oral suspension**

Noxafil oral suspension is indicated for the adult population ( $\geq 18$  years old) only. Another formulation (Noxafil gastro-resistant powder and solvent for oral suspension) is available for paediatric patients from 2 years to less than 18 years of age.

The oral suspension is not to be used interchangeably with either the tablet or gastro-resistant powder and solvent for oral suspension due to the differences in frequency of dosing, administration with food and plasma drug concentration achieved. Therefore, follow the specific dose recommendations for each formulation.

#### Posology

Noxafil is also available as 100 mg gastro-resistant tablet, 300 mg concentrate for solution for infusion, and 300 mg gastro-resistant powder and solvent for oral suspension. Noxafil tablets generally provide higher plasma drug exposures than Noxafil oral suspension under both fed and fasted conditions. Therefore, the tablets are the preferred formulation over the oral suspension to optimize plasma concentrations.

Recommended dose is shown in Table 1.

**Table 1.** Recommended dose in adults according to indication

<b>Indication</b>	<b>Dose and duration of therapy</b> (See section 5.2)
Refractory invasive fungal infections (IFI)/patients with IFI intolerant to 1 <sup>st</sup> line therapy	200 mg (5 mL) four times a day. Alternatively, patients who can tolerate food or a nutritional supplement may take 400 mg (10 mL) twice a day during or immediately following a meal or nutritional supplement. Duration of therapy should be based on the severity of the underlying disease, recovery from immunosuppression, and clinical response.
Oropharyngeal candidiasis	Loading dose of 200 mg (5 mL) once a day on the first day, then 100 mg (2.5 mL) once a day for 13 days. Each dose of Noxafil should be administered during or immediately after a meal, or a nutritional supplement in patients who cannot tolerate food to enhance the oral absorption and to ensure adequate exposure.
Prophylaxis of invasive fungal infections	200 mg (5 mL) three times a day. Each dose of Noxafil should be administered during or immediately after a meal, or a nutritional supplement in patients who cannot tolerate food to enhance the oral absorption and to ensure adequate exposure. The duration of therapy is based on recovery from neutropenia or immunosuppression. For patients with acute myelogenous leukaemia or myelodysplastic syndromes, prophylaxis with Noxafil should start several days before the anticipated onset of neutropenia and continue for 7 days after the neutrophil count rises above 500 cells per mm <sup>3</sup> .

## Special populations

### *Renal impairment*

An effect of renal impairment on the pharmacokinetics of posaconazole is not expected and no dose adjustment is recommended (see section 5.2).

### *Hepatic impairment*

Limited data on the effect of hepatic impairment (including Child-Pugh C classification of chronic liver disease) on the pharmacokinetics of posaconazole demonstrate an increase in plasma exposure compared to subjects with normal hepatic function, but do not suggest that dose adjustment is necessary (see sections 4.4 and 5.2). It is recommended to exercise caution due to the potential for higher plasma exposure.

### *Paediatric population*

The safety and efficacy of posaconazole oral suspension have not been established in children and adolescents aged below 18 years. Currently available data are described in sections 5.1 and 5.2, but no recommendation on a posology can be made. Two other oral formulations, Noxafil gastro-resistant powder and solvent for oral suspension and Noxafil tablets, are available for the paediatric population.

## Method of administration

For oral use

The oral suspension must be shaken well before use.

## **4.3 Contraindications**

Hypersensitivity to the active substance or to any of the excipients listed in section 6.1.

Co-administration with ergot alkaloids (see section 4.5).

Co-administration with the CYP3A4 substrates terfenadine, astemizole, cisapride, pimozone, halofantrine or quinidine since this may result in increased plasma concentrations of these medicinal products, leading to QTc prolongation and rare occurrences of torsades de pointes (see sections 4.4 and 4.5).

Co-administration with the HMG-CoA reductase inhibitors simvastatin, lovastatin and atorvastatin (see section 4.5).

Co-administration during the initiation and dose-titration phase of venetoclax in Chronic Lymphocytic Leukaemia (CLL) patients (see sections 4.4 and 4.5).

## **4.4 Special warnings and precautions for use**

### Hypersensitivity

There is no information regarding cross-sensitivity between posaconazole and other azole antifungal agents. Caution should be used when prescribing posaconazole to patients with hypersensitivity to other azoles.

### Hepatic toxicity

Hepatic reactions (e.g. mild to moderate elevations in ALT, AST, alkaline phosphatase, total bilirubin and/or clinical hepatitis) have been reported during treatment with posaconazole. Elevated liver function tests were generally reversible on discontinuation of therapy and in some instances these tests normalised without interruption of therapy. Rarely, more severe hepatic reactions with fatal outcomes have been reported.

Posaconazole should be used with caution in patients with hepatic impairment due to limited clinical experience and the possibility that posaconazole plasma levels may be higher in these patients (see sections 4.2 and 5.2).

### Monitoring of hepatic function

Liver function tests should be evaluated at the start of and during the course of posaconazole therapy. Patients who develop abnormal liver function tests during posaconazole therapy must be routinely monitored for the development of more severe hepatic injury. Patient management should include laboratory evaluation of hepatic function (particularly liver function tests and bilirubin). Discontinuation of posaconazole should be considered if clinical signs and symptoms are consistent with development of liver disease.

### QTc prolongation

Some azoles have been associated with prolongation of the QTc interval. Posaconazole must not be administered with medicinal products that are substrates for CYP3A4 and are known to prolong the QTc interval (see sections 4.3 and 4.5). Posaconazole should be administered with caution to patients with pro-arrhythmic conditions such as:

- Congenital or acquired QTc prolongation
- Cardiomyopathy, especially in the presence of cardiac failure
- Sinus bradycardia
- Existing symptomatic arrhythmias
- Concomitant use with medicinal products known to prolong the QTc interval (other than those mentioned in section 4.3).

Electrolyte disturbances, especially those involving potassium, magnesium or calcium levels, should be monitored and corrected as necessary before and during posaconazole therapy.

### Drug interactions

Posaconazole is an inhibitor of CYP3A4 and should only be used under specific circumstances during treatment with other medicinal products that are metabolised by CYP3A4 (see section 4.5).

### Midazolam and other benzodiazepines

Due to the risk of prolonged sedation and possible respiratory depression co-administration of posaconazole with any benzodiazepines metabolised by CYP3A4 (e.g. midazolam, triazolam, alprazolam) should only be considered if clearly necessary. Dose adjustment of benzodiazepines metabolised by CYP3A4 should be considered (see section 4.5).

### Vincristine toxicity

Concomitant administration of azole antifungals, including posaconazole, with vincristine has been associated with neurotoxicity and other serious adverse reactions, including seizures, peripheral neuropathy, syndrome of inappropriate antidiuretic hormone secretion, and paralytic ileus. Reserve azole antifungals, including posaconazole, for patients receiving a vinca alkaloid, including vincristine, who have no alternative antifungal treatment options (see section 4.5).

### Venetoclax toxicity

Concomitant administration of strong CYP3A inhibitors, including posaconazole, with the CYP3A4 substrate venetoclax, may increase venetoclax toxicities, including the risk of tumour lysis syndrome (TLS) and neutropenia (see sections 4.3 and 4.5). Refer to the venetoclax SmPC for detailed guidance.

### Rifamycin antibacterials (rifampicin, rifabutin), certain anticonvulsants (phenytoin, carbamazepine, phenobarbital, primidone), efavirenz and cimetidine

Posaconazole concentrations may be significantly lowered in combination; therefore, concomitant use with posaconazole should be avoided unless the benefit to the patient outweighs the risk (see section 4.5).

### Gastrointestinal dysfunction

There are limited pharmacokinetic data in patients with severe gastrointestinal dysfunction (such as severe diarrhoea). Patients who have severe diarrhoea or vomiting should be monitored closely for breakthrough fungal infections.

#### Glucose

This medicinal product contains approximately 1.75 g of glucose per 5 mL of suspension. Patients with rare glucose-galactose malabsorption should not take this medicinal product.

#### Sodium

This medicinal product contains less than 1 mmol sodium (23 mg) per dose, that is to say essentially 'sodium-free'.

#### Sodium benzoate

This medicinal product contains 10 mg of sodium benzoate (E211) per 5 mL of suspension.

#### Benzyl alcohol

This medicinal product contains up to 1.25 mg of benzyl alcohol per 5 mL of suspension. Benzyl alcohol may cause anaphylactoid reactions.

#### Propylene glycol

This medicinal product contains up to 24.75 mg of propylene glycol (E1520) per 5 mL of suspension.

### **4.5 Interaction with other medicinal products and other forms of interaction**

#### Effects of other medicinal products on posaconazole

Posaconazole is metabolised via UDP glucuronidation (phase 2 enzymes) and is a substrate for p-glycoprotein (P-gp) efflux *in vitro*. Therefore, inhibitors (e.g. verapamil, ciclosporin, quinidine, clarithromycin, erythromycin, etc.) or inducers (e.g. rifampicin, rifabutin, certain anticonvulsants, etc.) of these clearance pathways may increase or decrease posaconazole plasma concentrations, respectively.

#### *Rifabutin*

Rifabutin (300 mg once a day) decreased the  $C_{max}$  (maximum plasma concentration) and AUC (area under the plasma concentration time curve) of posaconazole to 57 % and 51 %, respectively. Concomitant use of posaconazole and rifabutin and similar inducers (e.g. rifampicin) should be avoided unless the benefit to the patient outweighs the risk. See also below regarding the effect of posaconazole on rifabutin plasma levels.

#### *Efavirenz*

Efavirenz (400 mg once a day) decreased the  $C_{max}$  and AUC of posaconazole by 45 % and 50 %, respectively. Concomitant use of posaconazole and efavirenz should be avoided unless the benefit to the patient outweighs the risk.

#### *Fosamprenavir*

Combining fosamprenavir with posaconazole may lead to decreased posaconazole plasma concentrations. If concomitant administration is required, close monitoring for breakthrough fungal infections is recommended. Repeat dose administration of fosamprenavir (700 mg twice daily x 10 days) decreased the  $C_{max}$  and AUC of posaconazole oral suspension (200 mg once daily on the 1<sup>st</sup> day, 200 mg twice daily on the 2<sup>nd</sup> day, then 400 mg twice daily x 8 days) by 21 % and 23 %, respectively. The effect of posaconazole on fosamprenavir levels when fosamprenavir is given with ritonavir is unknown.

#### *Phenytoin*

Phenytoin (200 mg once a day) decreased the  $C_{max}$  and AUC of posaconazole by 41 % and 50 %, respectively. Concomitant use of posaconazole and phenytoin and similar inducers (e.g. carbamazepine, phenobarbital, primidone) should be avoided unless the benefit to the patient outweighs the risk.

#### *H<sub>2</sub> receptor antagonists and proton pump inhibitors*

Posaconazole plasma concentrations ( $C_{max}$  and AUC) were reduced by 39 % when posaconazole was administered with cimetidine (400 mg twice a day) due to reduced absorption possibly secondary to a

decrease in gastric acid production. Co-administration of posaconazole with H<sub>2</sub> receptor antagonists should be avoided if possible.

Similarly, administration of 400 mg posaconazole with esomeprazole (40 mg daily) decreased mean C<sub>max</sub> and AUC by 46 % and 32 %, respectively, compared to dosing with 400 mg posaconazole alone. Co-administration of posaconazole with proton pump inhibitors should be avoided if possible.

#### *Food*

The absorption of posaconazole is significantly increased by food (see sections 4.2 and 5.2).

#### Effects of posaconazole on other medicinal products

Posaconazole is a potent inhibitor of CYP3A4. Co-administration of posaconazole with CYP3A4 substrates may result in large increases in exposure to CYP3A4 substrates as exemplified by the effects on tacrolimus, sirolimus, atazanavir and midazolam below. Caution is advised during co-administration of posaconazole with CYP3A4 substrates administered intravenously and the dose of the CYP3A4 substrate may need to be reduced. If posaconazole is used concomitantly with CYP3A4 substrates that are administered orally, and for which an increase in plasma concentrations may be associated with unacceptable adverse reactions, plasma concentrations of the CYP3A4 substrate and/or adverse reactions should be closely monitored and the dose adjusted as needed. Several of the interaction studies were conducted in healthy volunteers in whom a higher exposure to posaconazole occurs compared to patients administered the same dose. The effect of posaconazole on CYP3A4 substrates in patients might be somewhat lower than that observed in healthy volunteers, and is expected to be variable between patients due to the variable posaconazole exposure in patients. The effect of co-administration with posaconazole on plasma levels of CYP3A4 substrates may also be variable within a patient, unless posaconazole is administered in a strictly standardised way with food, given the large food effect on posaconazole exposure (see section 5.2).

#### *Terfenadine, astemizole, cisapride, pimozide, halofantrine and quinidine (CYP3A4 substrates)*

Co-administration of posaconazole and terfenadine, astemizole, cisapride, pimozide, halofantrine or quinidine is contraindicated. Co-administration may result in increased plasma concentrations of these medicinal products, leading to QTc prolongation and rare occurrences of torsades de pointes (see section 4.3).

#### *Ergot alkaloids*

Posaconazole may increase the plasma concentration of ergot alkaloids (ergotamine and dihydroergotamine), which may lead to ergotism. Co-administration of posaconazole and ergot alkaloids is contraindicated (see section 4.3).

#### *HMG-CoA reductase inhibitors metabolised through CYP3A4 (e.g. simvastatin, lovastatin, and atorvastatin)*

Posaconazole may substantially increase plasma levels of HMG-CoA reductase inhibitors that are metabolised by CYP3A4. Treatment with these HMG-CoA reductase inhibitors should be discontinued during treatment with posaconazole as increased levels have been associated with rhabdomyolysis (see section 4.3).

#### *Vinca alkaloids*

Most of the vinca alkaloids (e.g. vincristine and vinblastine) are substrates of CYP3A4. Concomitant administration of azole antifungals, including posaconazole, with vincristine has been associated with serious adverse reactions (see section 4.4). Posaconazole may increase the plasma concentrations of vinca alkaloids which may lead to neurotoxicity and other serious adverse reactions. Therefore, reserve azole antifungals, including posaconazole, for patients receiving a vinca alkaloid, including vincristine, who have no alternative antifungal treatment options.

#### *Rifabutin*

Posaconazole increased the C<sub>max</sub> and AUC of rifabutin by 31 % and 72 %, respectively. Concomitant use of posaconazole and rifabutin should be avoided unless the benefit to the patient outweighs the risk (see also above regarding the effect of rifabutin on plasma levels of posaconazole). If these

medicinal products are co-administered, careful monitoring of full blood counts and adverse reactions related to increased rifabutin levels (e.g. uveitis) is recommended.

#### *Sirolimus*

Repeat dose administration of posaconazole oral suspension (400 mg twice daily for 16 days) increased the  $C_{max}$  and AUC of sirolimus (2 mg single dose) an average of 6.7-fold and 8.9-fold (range 3.1 to 17.5-fold), respectively, in healthy subjects. The effect of posaconazole on sirolimus in patients is unknown, but is expected to be variable due to the variable posaconazole exposure in patients. Co-administration of posaconazole with sirolimus is not recommended and should be avoided whenever possible. If it is considered that co-administration is unavoidable, then it is recommended that the dose of sirolimus should be greatly reduced at the time of initiation of posaconazole therapy and that there should be very frequent monitoring of trough concentrations of sirolimus in whole blood. Sirolimus concentrations should be measured upon initiation, during co-administration, and at discontinuation of posaconazole treatment, with sirolimus doses adjusted accordingly. It should be noted that the relationship between sirolimus trough concentration and AUC is changed during co-administration with posaconazole. As a result, sirolimus trough concentrations that fall within the usual therapeutic range may result in sub-therapeutic levels. Therefore trough concentrations that fall in the upper part of the usual therapeutic range should be targeted and careful attention should be paid to clinical signs and symptoms, laboratory parameters and tissue biopsies.

#### *Ciclosporin*

In heart transplant patients on stable doses of ciclosporin, posaconazole oral suspension 200 mg once daily increased ciclosporin concentrations requiring dose reductions. Cases of elevated ciclosporin levels resulting in serious adverse reactions, including nephrotoxicity and one fatal case of leukoencephalopathy, were reported in clinical efficacy studies. When initiating treatment with posaconazole in patients already receiving ciclosporin, the dose of ciclosporin should be reduced (e.g. to about three quarters of the current dose). Thereafter blood levels of ciclosporin should be monitored carefully during co-administration, and upon discontinuation of posaconazole treatment, and the dose of ciclosporin should be adjusted as necessary.

#### *Tacrolimus*

Posaconazole increased  $C_{max}$  and AUC of tacrolimus (0.05 mg/kg body weight single dose) by 121 % and 358 %, respectively. Clinically significant interactions resulting in hospitalisation and/or posaconazole discontinuation were reported in clinical efficacy studies. When initiating posaconazole treatment in patients already receiving tacrolimus, the dose of tacrolimus should be reduced (e.g. to about one third of the current dose). Thereafter blood levels of tacrolimus should be monitored carefully during co-administration, and upon discontinuation of posaconazole, and the dose of tacrolimus should be adjusted as necessary.

#### *HIV Protease inhibitors*

As HIV protease inhibitors are CYP3A4 substrates, it is expected that posaconazole will increase plasma levels of these antiretroviral agents. Following co-administration of posaconazole oral suspension (400 mg twice daily) with atazanavir (300 mg once daily) for 7 days in healthy subjects  $C_{max}$  and AUC of atazanavir increased by an average of 2.6-fold and 3.7-fold (range 1.2 to 26-fold), respectively. Following co-administration of posaconazole oral suspension (400 mg twice daily) with atazanavir and ritonavir (300/100 mg once daily) for 7 days in healthy subjects  $C_{max}$  and AUC of atazanavir increased by an average of 1.5-fold and 2.5-fold (range 0.9 to 4.1-fold), respectively. The addition of posaconazole to therapy with atazanavir or with atazanavir plus ritonavir was associated with increases in plasma bilirubin levels. Frequent monitoring for adverse reactions and toxicity related to antiretroviral agents that are substrates of CYP3A4 is recommended during co-administration with posaconazole.

#### *Midazolam and other benzodiazepines metabolised by CYP3A4*

In a study in healthy volunteers posaconazole oral suspension (200 mg once daily for 10 days) increased the exposure (AUC) of intravenous midazolam (0.05 mg/kg) by 83 %. In another study in healthy volunteers, repeat dose administration of posaconazole oral suspension (200 mg twice daily for 7 days) increased the  $C_{max}$  and AUC of intravenous midazolam (0.4 mg single dose) by an average



of 1.3- and 4.6-fold (range 1.7 to 6.4-fold), respectively; Posaconazole oral suspension 400 mg twice daily for 7 days increased the intravenous midazolam  $C_{max}$  and AUC by 1.6 and 6.2-fold (range 1.6 to 7.6-fold), respectively. Both doses of posaconazole increased  $C_{max}$  and AUC of oral midazolam (2 mg single oral dose) by 2.2 and 4.5-fold, respectively. In addition, posaconazole oral suspension (200 mg or 400 mg) prolonged the mean terminal half-life of midazolam from approximately 3-4 hours to 8-10 hours during co-administration.

Due to the risk of prolonged sedation it is recommended that dose adjustments should be considered when posaconazole is administered concomitantly with any benzodiazepine that is metabolised by CYP3A4 (e.g. midazolam, triazolam, alprazolam) (see section 4.4).

*Calcium channel blockers metabolised through CYP3A4 (e.g. diltiazem, verapamil, nifedipine, nisoldipine)*

Frequent monitoring for adverse reactions and toxicity related to calcium channel blockers is recommended during co-administration with posaconazole. Dose adjustment of calcium channel blockers may be required.

*Digoxin*

Administration of other azoles has been associated with increases in digoxin levels. Therefore, posaconazole may increase plasma concentration of digoxin and digoxin levels need to be monitored when initiating or discontinuing posaconazole treatment.

*Sulfonylureas*

Glucose concentrations decreased in some healthy volunteers when glipizide was co-administered with posaconazole. Monitoring of glucose concentrations is recommended in diabetic patients.

*All-trans retinoic acid (ATRA) or tretinoin*

As ATRA is metabolised by the hepatic CYP450 enzymes, notably CYP3A4, concomitant administration with posaconazole, which is a strong inhibitor of CYP3A4, may lead to increased exposure to tretinoin resulting in an increased toxicity (especially hypercalcaemia). Serum calcium levels should be monitored and, if needed, appropriate dose adjustments of tretinoin should be considered during the treatment with posaconazole, and during the following days after treatment.

*Venetoclax*

Compared with venetoclax 400 mg administered alone, co-administration of 300 mg posaconazole, a strong CYP3A inhibitor, with venetoclax 50 mg and 100 mg for 7 days in 12 patients, increased venetoclax  $C_{max}$  to 1.6-fold and 1.9-fold, and AUC to 1.9-fold and 2.4-fold, respectively (see sections 4.3 and 4.4).

Refer to the venetoclax SmPC.

Paediatric population

Interaction studies have only been performed in adults.

## **4.6 Fertility, pregnancy and lactation**

Pregnancy

There is insufficient information on the use of posaconazole in pregnant women. Studies in animals have shown reproductive toxicity (see section 5.3). The potential risk for humans is unknown.

Women of childbearing potential have to use effective contraception during treatment. Posaconazole must not be used during pregnancy unless the benefit to the mother clearly outweighs the potential risk to the foetus.

Breast-feeding

Posaconazole is excreted into the milk of lactating rats (see section 5.3). The excretion of posaconazole in human breast milk has not been investigated. Breast-feeding must be stopped on initiation of treatment with posaconazole.

### Fertility

Posaconazole had no effect on fertility of male rats at doses up to 180 mg/kg (1.7 times the 400-mg twice daily regimen based on steady-state plasma concentrations in healthy volunteers) or female rats at a dose up to 45 mg/kg (2.2 times the 400-mg twice daily regimen). There is no clinical experience assessing the impact of posaconazole on fertility in humans.

### **4.7 Effects on ability to drive and use machines**

Since certain adverse reactions (e.g. dizziness, somnolence, etc.) have been reported with posaconazole use, which potentially may affect driving/operating machinery, caution needs to be used.

### **4.8 Undesirable effects**

#### Summary of the safety profile

The safety of posaconazole oral suspension has been assessed in > 2,400 patients and healthy volunteers enrolled in clinical studies and from post-marketing experience. The most frequently reported serious related adverse reactions included nausea, vomiting, diarrhoea, pyrexia, and increased bilirubin.

#### Tabulated list of adverse reactions

Within the organ system classes, adverse reactions are listed under headings of frequency using the following categories: very common ( $\geq 1/10$ ); common ( $\geq 1/100$  to  $< 1/10$ ); uncommon ( $\geq 1/1,000$  to  $< 1/100$ ); rare ( $\geq 1/10,000$  to  $< 1/1,000$ ); very rare ( $< 1/10,000$ ); not known (cannot be estimated from the available data).

**Table 2.** Adverse reactions by body system and frequency reported in clinical studies and/or post-marketing use \*

<b>Blood and lymphatic system disorders</b>	
Common:	neutropenia
Uncommon:	thrombocytopenia, leukopenia, anaemia, eosinophilia, lymphadenopathy, splenic infarction
Rare:	haemolytic uraemic syndrome, thrombotic thrombocytopenic purpura, pancytopenia, coagulopathy, haemorrhage
<b>Immune system disorders</b>	
Uncommon:	allergic reaction
Rare:	hypersensitivity reaction
<b>Endocrine disorders</b>	
Rare:	adrenal insufficiency, blood gonadotropin decreased, pseudoaldosteronism
<b>Metabolism and nutrition disorders</b>	
Common:	electrolyte imbalance, anorexia, decreased appetite, hypokalaemia, hypomagnesaemia
Uncommon:	hyperglycaemia, hypoglycaemia
<b>Psychiatric disorders</b>	
Uncommon:	abnormal dreams, confusional state, sleep disorder
Rare:	psychotic disorder, depression
<b>Nervous system disorders</b>	
Common:	paraesthesia, dizziness, somnolence, headache, dysgeusia
Uncommon:	convulsions, neuropathy, hypoaesthesia, tremor, aphasia, insomnia
Rare:	cerebrovascular accident, encephalopathy, peripheral neuropathy, syncope

<b>Eye disorders</b> Uncommon: Rare:	blurred vision, photophobia, visual acuity reduced diplopia, scotoma
<b>Ear and labyrinth disorder</b> Rare:	hearing impairment
<b>Cardiac disorders</b> Uncommon: Rare:	long QT syndrome <sup>§</sup> , electrocardiogram abnormal <sup>§</sup> , palpitations, bradycardia, supraventricular extrasystoles, tachycardia torsade de pointes, sudden death, ventricular tachycardia, cardio-respiratory arrest, cardiac failure, myocardial infarction
<b>Vascular disorders</b> Common: Uncommon: Rare:	hypertension hypotension, vasculitis pulmonary embolism, deep vein thrombosis
<b>Respiratory, thoracic and mediastinal disorders</b> Uncommon: Rare:	cough, epistaxis, hiccups, nasal congestion, pleuritic pain, tachypnoea pulmonary hypertension, interstitial pneumonia, pneumonitis
<b>Gastrointestinal disorders</b> Very Common: Common: Uncommon: Rare:	nausea vomiting, abdominal pain, diarrhoea, dyspepsia, dry mouth, flatulence, constipation, anorectal discomfort pancreatitis, abdominal distension, enteritis, epigastric discomfort, eructation, gastroesophageal reflux disease, oedema mouth gastrointestinal haemorrhage, ileus
<b>Hepatobiliary disorders</b> Common: Uncommon: Rare:	liver function tests raised (ALT increased, AST increased, bilirubin increased, alkaline phosphatase increased, GGT increased) hepatocellular damage, hepatitis, jaundice, hepatomegaly, cholestasis, hepatic toxicity, hepatic function abnormal hepatic failure, hepatitis cholestatic, hepatosplenomegaly, liver tenderness, asterixis
<b>Skin and subcutaneous tissue disorders</b> Common: Uncommon: Rare:	rash, pruritis mouth ulceration, alopecia, dermatitis, erythema, petechiae Stevens Johnson syndrome, vesicular rash
<b>Musculoskeletal and connective tissue disorders</b> Uncommon:	back pain, neck pain, musculoskeletal pain, pain in extremity
<b>Renal and urinary disorders</b> Uncommon: Rare:	acute renal failure, renal failure, blood creatinine increased renal tubular acidosis, interstitial nephritis
<b>Reproductive system and breast disorders</b> Uncommon: Rare:	menstrual disorder breast pain
<b>General disorders and administration site conditions</b> Common:	pyrexia (fever), asthenia, fatigue

Uncommon:	oedema, pain, chills, malaise, chest discomfort, drug intolerance, feeling jittery, mucosal inflammation
Rare:	tongue oedema, face oedema
<b>Investigations</b>	
Uncommon:	altered medicine levels, blood phosphorus decreased, chest x-ray abnormal

\* Based on adverse reactions observed with the oral suspension, gastro-resistant tablets, concentrate for solution for infusion, and gastro-resistant powder and solvent for oral suspension.

§ See section 4.4.

### Description of selected adverse reactions

#### *Hepatobiliary disorders*

During post-marketing surveillance of posaconazole oral suspension, severe hepatic injury with fatal outcome has been reported (see section 4.4).

### Reporting of suspected adverse reactions

Reporting suspected adverse reactions after authorisation of the medicinal product is important. It allows continued monitoring of the benefit/risk balance of the medicinal product. Healthcare professionals are asked to report any suspected adverse reactions via [the national reporting system listed in Appendix V](#).

## 4.9 Overdose

During clinical studies, patients who received posaconazole oral suspension doses up to 1,600 mg/day experienced no different adverse reactions from those reported with patients at the lower doses.

Accidental overdose was noted in one patient who took posaconazole oral suspension 1,200 mg twice a day for 3 days. No adverse reactions were noted by the investigator.

Posaconazole is not removed by haemodialysis. There is no special treatment available in the case of overdose with posaconazole. Supportive care may be considered.

## 5. PHARMACOLOGICAL PROPERTIES

### 5.1 Pharmacodynamic properties

Pharmacotherapeutic group: Antimycotics for systemic use, triazole derivatives, ATC code: J02AC04.

#### Mechanism of action

Posaconazole inhibits the enzyme lanosterol 14 $\alpha$ -demethylase (CYP51), which catalyses an essential step in ergosterol biosynthesis.

#### Microbiology

Posaconazole has been shown *in vitro* to be active against the following microorganisms: *Aspergillus* species (*Aspergillus fumigatus*, *A. flavus*, *A. terreus*, *A. nidulans*, *A. niger*, *A. ustus*), *Candida* species (*Candida albicans*, *C. glabrata*, *C. krusei*, *C. parapsilosis*, *C. tropicalis*, *C. dubliniensis*, *C. famata*, *C. inconspicua*, *C. lipolytica*, *C. norvegensis*, *C. pseudotropicalis*), *Coccidioides immitis*, *Fonsecaea pedrosoi*, and species of *Fusarium*, *Rhizomucor*, *Mucor*, and *Rhizopus*. The microbiological data suggest that posaconazole is active against *Rhizomucor*, *Mucor*, and *Rhizopus*; however the clinical data are currently too limited to assess the efficacy of posaconazole against these causative agents.

The following *in vitro* data are available, but their clinical significance is unknown. In a surveillance study of > 3,000 clinical mold isolates from 2010-2018, 90 % of non-*Aspergillus* fungi exhibited the following *in vitro* minimum inhibitory concentration (MIC): *Mucorales* spp (n=81) of 2 mg/L; *Scedosporium apiospermum*/*S. boydii* (n=65) of 2 mg/L; *Exophiala dermatiditis* (n=15) of 0.5 mg/L, and *Purpureocillium lilacinum* (n=21) of 1 mg/L.

## Resistance

Clinical isolates with decreased susceptibility to posaconazole have been identified. The principle mechanism of resistance is the acquisition of substitutions in the target protein, CYP51.

## Epidemiological Cut-off (ECOFF) Values for *Aspergillus* spp.

The ECOFF values for posaconazole, which distinguish the wild type population from isolates with acquired resistance, have been determined by EUCAST methodology.

EUCAST ECOFF values:

- *Aspergillus flavus*: 0.5 mg/L
- *Aspergillus fumigatus*: 0.5 mg/L
- *Aspergillus nidulans*: 0.5 mg/L
- *Aspergillus niger*: 0.5 mg/L
- *Aspergillus terreus*: 0.25 mg/L

There are currently insufficient data to set clinical breakpoints for *Aspergillus* spp. ECOFF values do not equate to clinical breakpoints.

## Breakpoints

EUCAST MIC breakpoints for posaconazole [susceptible (S); resistant (R)]:

- *Candida albicans*: S  $\leq$ 0.06 mg/L, R >0.06 mg/L
- *Candida tropicalis*: S  $\leq$ 0.06 mg/L, R >0.06 mg/L
- *Candida parapsilosis*: S  $\leq$ 0.06 mg/L, R >0.06 mg/L
- *Candida dubliniensis*: S  $\leq$ 0.06 mg/L, R > 0.06 mg/L

There are currently insufficient data to set clinical breakpoints for other *Candida* species.

## Combination with other antifungal agents

The use of combination antifungal therapies should not decrease the efficacy of either posaconazole or the other therapies; however, there is currently no clinical evidence that combination therapy will provide an added benefit.

## Pharmacokinetic / Pharmacodynamic relationships

A correlation between total medicinal product exposure divided by MIC (AUC/MIC) and clinical outcome was observed. The critical ratio for subjects with *Aspergillus* infections was ~200. It is particularly important to try to ensure that maximal plasma levels are achieved in patients infected with *Aspergillus* (see sections 4.2 and 5.2 on recommended dose regimens and the effects of food on absorption).

## Clinical experience

### *Summary of posaconazole oral suspension studies*

#### *Invasive aspergillosis*

Oral posaconazole suspension 800 mg/day in divided doses was evaluated for the treatment of invasive aspergillosis in patients with disease refractory to amphotericin B (including liposomal formulations) or itraconazole or in patients who were intolerant of these medicinal products in a non-comparative salvage therapy study (Study 0041). Clinical outcomes were compared with those in an external control group derived from a retrospective review of medical records. The external control group included 86 patients treated with available therapy (as above) mostly at the same time and at the same sites as the patients treated with posaconazole. Most of the cases of aspergillosis were considered to be refractory to prior therapy in both the posaconazole group (88 %) and in the external control group (79 %).

As shown in Table 3, a successful response (complete or partial resolution) at the end of treatment was seen in 42 % of posaconazole-treated patients compared to 26 % of the external group. However, this

was not a prospective, randomised controlled study and so all comparisons with the external control group should be viewed with caution.

**Table 3.** Overall efficacy of posaconazole oral suspension at the end of treatment for invasive aspergillosis in comparison to an external control group

	<b>Posaconazole oral suspension</b>	<b>External control group</b>
Overall Response	45/107 (42 %)	22/86 (26 %)
<b>Success by Species</b>		
All mycologically confirmed <i>Aspergillus</i> spp. <sup>1</sup>		
<i>A. fumigatus</i>	34/76 (45 %)	19/74 (26 %)
<i>A. flavus</i>	12/29 (41 %)	12/34 (35 %)
<i>A. terreus</i>	10/19 (53 %)	3/16 (19 %)
<i>A. niger</i>	4/14 (29 %)	2/13 (15 %)
	3/5 (60 %)	2/7 (29 %)

#### *Fusarium* spp.

11 of 24 patients who had proven or probable fusariosis were successfully treated with posaconazole oral suspension 800 mg/day in divided doses for a median of 124 days and up to 212 days. Among eighteen patients who were intolerant or had infections refractory to amphotericin B or itraconazole, seven patients were classed as responders.

#### *Chromoblastomycosis/Mycetoma*

9 of 11 patients were successfully treated with posaconazole oral suspension 800 mg/day in divided doses for a median of 268 days and up to 377 days. Five of these patients had chromoblastomycosis due to *Fonsecaea pedrosoi* and 4 had mycetoma, mostly due to *Madurella* species.

#### *Coccidioidomycosis*

11 of 16 patients were successfully treated (at the end of treatment complete or partial resolution of signs and symptoms present at baseline) with posaconazole oral suspension 800 mg/day in divided doses for a median of 296 days and up to 460 days.

#### *Treatment of azole-susceptible Oropharyngeal Candidiasis (OPC)*

A randomised, evaluator-blind, controlled study was completed in HIV-infected patients with azole-susceptible oropharyngeal candidiasis (most patients studied had *C. albicans* isolated at baseline). The primary efficacy variable was the clinical success rate (defined as cure or improvement) after 14 days of treatment. Patients were treated with posaconazole or fluconazole oral suspension (both posaconazole and fluconazole were given as follows: 100 mg twice a day for 1 day followed by 100 mg once a day for 13 days).

The clinical response rates from the above study are shown in the Table 4 below.

Posaconazole was shown to be non-inferior to fluconazole for clinical success rates at Day 14 as well as 4 weeks after the end of treatment.

**Table 4.** Clinical success rates in Oropharyngeal Candidiasis

<b>Endpoint</b>	<b>Posaconazole</b>	<b>Fluconazole</b>
Clinical success rate at Day 14	91.7 % (155/169)	92.5 % (148/160)
Clinical success rate 4 weeks after end of treatment	68.5 % (98/143)	61.8 % (84/136)

Clinical success rate was defined as the number of cases assessed as having a clinical response (cure or improvement) divided by the total number of cases eligible for analysis.

#### *Prophylaxis of Invasive Fungal Infections (IFIs) (Studies 316 and 1899)*

Two randomised, controlled prophylaxis studies were conducted among patients at high-risk for developing invasive fungal infections.

<sup>1</sup> Includes other less common species or species unknown

Study 316 was a randomised, double-blind study of posaconazole oral suspension (200 mg three times a day) versus fluconazole capsules (400 mg once daily) in allogeneic hematopoietic stem cell transplant recipients with graft-versus-host disease (GVHD). The primary efficacy endpoint was the incidence of proven/probable IFIs at 16 weeks post-randomisation as determined by an independent, blinded external expert panel. A key secondary endpoint was the incidence of proven/probable IFIs during the on-treatment period (first dose to last dose of study medicinal product + 7 days). The majority (377/600, [63 %]) of patients included had Acute Grade 2 or 3 or chronic extensive (195/600, [32.5 %]) GVHD at study start. The mean duration of therapy was 80 days for posaconazole and 77 days for fluconazole.

Study 1899 was a randomised, evaluator-blinded study of posaconazole oral suspension (200 mg three times a day) versus fluconazole suspension (400 mg once daily) or itraconazole oral solution (200 mg twice a day) in neutropenic patients who were receiving cytotoxic chemotherapy for acute myelogenous leukaemia or myelodysplastic syndromes. The primary efficacy endpoint was the incidence of proven/probable IFIs as determined by an independent, blinded external expert panel during the on-treatment period. A key secondary endpoint was the incidence of proven/probable IFIs at 100 days post-randomisation. New diagnosis of acute myelogenous leukaemia was the most common underlying condition (435/602, [72 %]). The mean duration of therapy was 29 days for posaconazole and 25 days for fluconazole/itraconazole.

In both prophylaxis studies, aspergillosis was the most common breakthrough infection. See Table 5 and 6 for results from both studies. There were fewer breakthrough *Aspergillus* infections in patients receiving posaconazole prophylaxis when compared to control patients.

**Table 5.** Results from clinical studies in prophylaxis of Invasive Fungal Infections

Study	Posaconazole oral suspension	Control <sup>a</sup>	P-Value
<b>Proportion (%) of patients with proven/probable IFIs</b>			
<b>On-treatment period<sup>b</sup></b>			
1899 <sup>d</sup>	7/304 (2)	25/298 (8)	0.0009
316 <sup>e</sup>	7/291 (2)	22/288 (8)	0.0038
<b>Fixed-time period<sup>c</sup></b>			
1899 <sup>d</sup>	14/304 (5)	33/298 (11)	0.0031
316 <sup>d</sup>	16/301 (5)	27/299 (9)	0.0740

FLU = fluconazole; ITZ = itraconazole; POS = posaconazole.

a: FLU/ITZ (1899); FLU (316).

b: In 1899 this was the period from randomisation to last dose of study medicinal product plus 7 days; in 316 it was the period from first dose to last dose of study medicinal product plus 7 days.

c: In 1899, this was the period from randomisation to 100 days post-randomisation; in 316 it was the period from the baseline day to 111 days post-baseline.

d: All randomised

e: All treated

**Table 6.** Results from clinical studies in prophylaxis of Invasive Fungal Infections

Study	Posaconazole oral suspension	Control <sup>a</sup>
<b>Proportion (%) of patients with proven/probable Aspergillosis</b>		
<b>On-treatment period<sup>b</sup></b>		
1899 <sup>d</sup>	2/304 (1)	20/298 (7)
316 <sup>e</sup>	3/291 (1)	17/288 (6)
<b>Fixed-time period<sup>c</sup></b>		
1899 <sup>d</sup>	4/304 (1)	26/298 (9)
316 <sup>d</sup>	7/301 (2)	21/299 (7)

FLU = fluconazole; ITZ = itraconazole; POS = posaconazole.

a: FLU/ITZ (1899); FLU (316).

b: In 1899 this was the period from randomisation to last dose of study medicinal product plus 7 days; in 316 it was the period from first dose to last dose of study medicinal product plus 7 days.

c: In 1899, this was the period from randomisation to 100 days post-randomisation; in 316 it was the period from the baseline day to 111 days post-baseline.

d: All randomised

e: All treated

In Study 1899, a significant decrease in all-cause mortality in favour of posaconazole was observed [POS 49/304 (16 %) vs. FLU/ITZ 67/298 (22 %) p= 0.048]. Based on Kaplan-Meier estimates, the probability of survival up to day 100 after randomisation, was significantly higher for posaconazole recipients; this survival benefit was demonstrated when the analysis considered all causes of death (P= 0.0354) as well as IFI-related deaths (P = 0.0209).

In Study 316, overall mortality was similar (POS, 25 %; FLU, 28 %); however, the proportion of IFI-related deaths was significantly lower in the POS group (4/301) compared with the FLU group (12/299; P= 0.0413).

#### Paediatric population

No dose of posaconazole oral suspension could be recommended for paediatric patients. However, the safety and efficacy of other formulations of posaconazole (Noxafil gastro-resistant powder and solvent for oral suspension; Noxafil concentrate for solution for infusion) have been established in paediatric patients 2 to less than 18 years of age. Refer to their SmPC for additional information.

#### Electrocardiogram evaluation

Multiple, time-matched ECGs collected over a 12-hour period were obtained before and during administration of posaconazole oral suspension (400 mg twice daily with high fat meals) from 173 healthy male and female volunteers aged 18 to 85 years. No clinically relevant changes in the mean QTc (Fridericia) interval from baseline were observed.

## **5.2 Pharmacokinetic properties**

#### Absorption

Posaconazole is absorbed with a median  $T_{max}$  of 3 hours (fed patients). The pharmacokinetics of posaconazole are linear following single and multiple dose administration of up to 800 mg when taken with a high fat meal. No further increases in exposure were observed when doses above 800 mg daily were administered to patients and healthy volunteers. In the fasting state, AUC increased less than in proportion to dose above 200 mg. In healthy volunteers under fasting conditions, dividing the total daily dose (800 mg) into 200 mg four times daily compared to 400 mg twice daily, was shown to increase posaconazole exposure by 2.6-fold.

#### Effect of food on oral absorption in healthy volunteers

The absorption of posaconazole was significantly increased when posaconazole 400 mg (once daily) was administered during and immediately after the consumption of a high fat meal (~ 50 grams fat) compared to administration before a meal, with  $C_{max}$  and AUC increasing by approximately 330 % and



360 %, respectively. The AUC of posaconazole is: 4 times greater when administered with a high-fat meal (~ 50 grams fat) and about 2.6 times greater when administered during a non-fat meal or nutritional supplement (14 grams fat) relative to the fasted state (see sections 4.2 and 4.5).

### Distribution

Posaconazole is slowly absorbed and slowly eliminated with a large apparent volume of distribution (1,774 litres) and is highly protein bound (> 98 %), predominantly to serum albumin.

### Biotransformation

Posaconazole does not have any major circulating metabolites and its concentrations are unlikely to be altered by inhibitors of CYP450 enzymes. Of the circulating metabolites, the majority are glucuronide conjugates of posaconazole with only minor amounts of oxidative (CYP450 mediated) metabolites observed. The excreted metabolites in urine and faeces account for approximately 17 % of the administered radiolabelled dose.

### Elimination

Posaconazole is slowly eliminated with a mean half-life ( $t_{1/2}$ ) of 35 hours (range 20 to 66 hours). After administration of  $^{14}\text{C}$ -posaconazole, radioactivity was predominantly recovered in the faeces (77 % of the radiolabelled dose) with the major component being parent compound (66 % of the radiolabelled dose). Renal clearance is a minor elimination pathway, with 14 % of the radiolabelled dose excreted in urine (< 0.2 % of the radiolabelled dose is parent compound). Steady-state is attained following 7 to 10 days of multiple-dose administration.

### Pharmacokinetics in special populations

#### *Children (< 18 years)*

Following administration of 800 mg per day of posaconazole as a divided dose for treatment of invasive fungal infections, mean trough plasma concentrations from 12 patients 8 - 17 years of age (776 ng/mL) were similar to concentrations from 194 patients 18 - 64 years of age (817 ng/mL). Similarly, in the prophylaxis studies, the mean steady-state posaconazole average concentration ( $C_{av}$ ) was comparable among ten adolescents (13-17 years of age) to  $C_{av}$  achieved in adults ( $\geq$  18 years of age). In a study of 136 neutropenic paediatric patients 11 months – 17 years treated with posaconazole oral suspension at doses up to 18 mg/kg/day divided TID, approximately 50 % met the pre-specified target (Day 7  $C_{av}$  between 500 ng/mL-2,500 ng/mL). In general, exposures tended to be higher in the older patients (7 to <18 years) than in younger patients (2 to <7 years).

#### *Gender*

The pharmacokinetics of posaconazole are comparable in men and women.

#### *Elderly*

An increase in  $C_{max}$  (26 %) and AUC (29 %) was observed in elderly subjects (24 subjects  $\geq$  65 years of age) relative to younger subjects (24 subjects 18 - 45 years of age). However, in clinical efficacy studies, the safety profile of posaconazole between the young and elderly patients was similar.

#### *Race*

There was a slight decrease (16 %) in the AUC and  $C_{max}$  of posaconazole oral suspension in Black subjects relative to Caucasian subjects. However, the safety profile of posaconazole between the Black and Caucasian subjects was similar.

#### *Weight*

The population pharmacokinetic model of posaconazole concentrate for solution for infusion and tablets indicates that posaconazole clearance is related to weight. In patients > 120 kg, the  $C_{av}$  is decreased by 25 % and in patients < 50 kg, the  $C_{av}$  is increased by 19 %. It is, therefore, suggested to closely monitor for breakthrough fungal infections in patients weighing more than 120 kg.

### *Renal impairment*

Following single-dose administration of posaconazole oral suspension, there was no effect of mild and moderate renal impairment (n=18,  $Cl_{cr} \geq 20$  mL/min/1.73 m<sup>2</sup>) on posaconazole pharmacokinetics; therefore, no dose adjustment is required. In subjects with severe renal impairment (n=6,  $Cl_{cr} < 20$  mL/min/1.73 m<sup>2</sup>), the AUC of posaconazole was highly variable [ $> 96$  % CV (coefficient of variance)] compared to other renal groups [ $< 40$  % CV]. However, as posaconazole is not significantly renally eliminated, an effect of severe renal impairment on the pharmacokinetics of posaconazole is not expected and no dose adjustment is recommended. Posaconazole is not removed by haemodialysis.

### *Hepatic impairment*

After a single oral dose of 400 mg posaconazole oral suspension to patients with mild (Child-Pugh Class A), moderate (Child-Pugh Class B) or severe (Child-Pugh Class C) hepatic impairment (six per group), the mean AUC was 1.3 to 1.6-fold higher compared to that for matched control subjects with normal hepatic function. Unbound concentrations were not determined and it cannot be excluded that there is a larger increase in unbound posaconazole exposure than the observed 60 % increase in total AUC. The elimination half-life ( $t_{1/2}$ ) was prolonged from approximately 27 hours up to ~43 hours in respective groups. No dose adjustment is recommended for patients with mild to severe hepatic impairment but caution is advised due to the potential for higher plasma exposure.

## **5.3 Preclinical safety data**

As observed with other azole antifungal agents, effects related to inhibition of steroid hormone synthesis were seen in repeated-dose toxicity studies with posaconazole. Adrenal suppressive effects were observed in toxicity studies in rats and dogs at exposures equal to or greater than those obtained at therapeutic doses in humans.

Neuronal phospholipidosis occurred in dogs dosed for  $\geq 3$  months at lower systemic exposures than those obtained at therapeutic doses in humans. This finding was not seen in monkeys dosed for one year. In twelve-month neurotoxicity studies in dogs and monkeys, no functional effects were observed on the central or peripheral nervous systems at systemic exposures greater than those achieved therapeutically.

Pulmonary phospholipidosis resulting in dilatation and obstruction of the alveoli was observed in the 2-year study in rats. These findings are not necessarily indicative of a potential for functional changes in humans.

No effects on electrocardiograms, including QT and QTc intervals, were seen in a repeat dose safety pharmacology study in monkeys at systemic exposures 4.6-fold greater than the concentrations obtained at therapeutic doses in humans. Echocardiography revealed no indication of cardiac decompensation in a repeat dose safety pharmacology study in rats at a systemic exposure 1.4-fold greater than that achieved therapeutically. Increased systolic and arterial blood pressures (up to 29 mm-Hg) were seen in rats and monkeys at systemic exposures 1.4-fold and 4.6-fold greater, respectively, than those achieved with the human therapeutic doses.

Reproduction, peri- and postnatal development studies were conducted in rats. At exposures lower than those obtained at therapeutic doses in humans, posaconazole caused skeletal variations and malformations, dystocia, increased length of gestation, reduced mean litter size and postnatal viability. In rabbits, posaconazole was embryotoxic at exposures greater than those obtained at therapeutic doses. As observed with other azole antifungal agents, these effects on reproduction were considered to be due to a treatment-related effect on steroidogenesis.

Posaconazole was not genotoxic in *in vitro* and *in vivo* studies. Carcinogenicity studies did not reveal special hazards for humans.

## **6. PHARMACEUTICAL PARTICULARS**

### **6.1 List of excipients**

Polysorbate 80  
Simeticone  
Sodium benzoate (E211)  
Sodium citrate dihydrate  
Citric acid monohydrate  
Glycerol  
Xanthan gum  
Liquid glucose  
Titanium dioxide (E171)  
Artificial cherry flavour containing benzyl alcohol and propylene glycol (E1520)  
Purified water

### **6.2 Incompatibilities**

Not applicable.

### **6.3 Shelf life**

Unopened container: 3 years

After first opening the container: 4 weeks

### **6.4 Special precautions for storage**

Do not freeze.

### **6.5 Nature and contents of container**

105 mL of oral suspension in a bottle (glass amber type IV) closed with a plastic child-resistant cap (polypropylene) and a measuring spoon (polystyrene) with 2 graduations: 2.5 mL and 5 mL.

### **6.6 Special precautions for disposal**

Any unused medicinal product or waste material should be disposed of in accordance with local requirements.

## **7. MARKETING AUTHORISATION HOLDER**

Merck Sharp & Dohme B.V.  
Waarderweg 39  
2031 BN Haarlem  
The Netherlands

## **8. MARKETING AUTHORISATION NUMBER(S)**

EU/1/05/320/001

## **9. DATE OF FIRST AUTHORISATION/RENEWAL OF THE AUTHORISATION**

Date of first authorisation: 25 October 2005

Date of latest renewal: 25 October 2010

**10. DATE OF REVISION OF THE TEXT**

<{MM/YYYY}>

Detailed information on this medicinal product is available on the website of the European Medicines Agency <http://www.ema.europa.eu>.

## **1. NAME OF THE MEDICINAL PRODUCT**

Noxafil 100 mg gastro-resistant tablets

## **2. QUALITATIVE AND QUANTITATIVE COMPOSITION**

Each gastro-resistant tablet contains 100 mg of posaconazole.

For the full list of excipients, see section 6.1.

## **3. PHARMACEUTICAL FORM**

Gastro-resistant tablet (tablet)

Yellow-coated, capsule-shaped tablet of 17.5 mm length debossed with “100” on one side.

## **4. CLINICAL PARTICULARS**

### **4.1 Therapeutic indications**

Noxafil gastro-resistant tablets are indicated for use in the treatment of the following fungal infections in adults (see sections 4.2 and 5.1):

- Invasive aspergillosis

Noxafil gastro-resistant tablets are indicated for use in the treatment of the following fungal infections in paediatric patients from 2 years of age weighing more than 40 kg and adults (see sections 4.2 and 5.1):

- Invasive aspergillosis in patients with disease that is refractory to amphotericin B or itraconazole or in patients who are intolerant of these medicinal products;
- Fusariosis in patients with disease that is refractory to amphotericin B or in patients who are intolerant of amphotericin B;
- Chromoblastomycosis and mycetoma in patients with disease that is refractory to itraconazole or in patients who are intolerant of itraconazole;
- Coccidioidomycosis in patients with disease that is refractory to amphotericin B, itraconazole or fluconazole or in patients who are intolerant of these medicinal products.

Refractoriness is defined as progression of infection or failure to improve after a minimum of 7 days of prior therapeutic doses of effective antifungal therapy.

Noxafil gastro-resistant tablets are also indicated for prophylaxis of invasive fungal infections in the following paediatric patients from 2 years of age weighing more than 40 kg and adults (see sections 4.2 and 5.1):

- Patients receiving remission-induction chemotherapy for acute myelogenous leukaemia (AML) or myelodysplastic syndromes (MDS) expected to result in prolonged neutropenia and who are at high-risk of developing invasive fungal infections;
- Hematopoietic stem cell transplant (HSCT) recipients who are undergoing high-dose immunosuppressive therapy for graft versus host disease and who are at high-risk of developing invasive fungal infections.

Please refer to the Summary of Product Characteristics of Noxafil oral suspension for use in oropharyngeal candidiasis.

## 4.2 Posology and method of administration

Treatment should be initiated by a physician experienced in the management of fungal infections or in the supportive care of high-risk patients for which posaconazole is indicated as prophylaxis.

### Non-interchangeability between Noxafil tablets and Noxafil oral suspension

The tablet is not to be used interchangeably with the oral suspension due to the differences between these two formulations in frequency of dosing, administration with food and plasma drug concentration achieved. Therefore, follow the specific dose recommendations for each formulation.

#### Posology

Noxafil is also available as 40 mg/mL oral suspension, 300 mg concentrate for solution for infusion, and 300 mg gastro-resistant powder and solvent for oral suspension. Noxafil tablets generally provide higher plasma drug exposures than Noxafil oral suspension under both fed and fasted conditions. Therefore, the tablets are the preferred formulation to optimise plasma concentrations.

Recommended dose in paediatric patients from 2 years of age weighing more than 40 kg and in adults is shown in Table 1.

Noxafil gastro-resistant powder and solvent for oral suspension is recommended for oral use in paediatric patients 2 years of age and older weighing 40 kg or less. Refer to the gastro-resistant powder and solvent for oral suspension SmPC for additional dosing information.

**Table 1.** Recommended dose in paediatric patients from 2 years of age weighing more than 40 kg and in adults according to indication

<b>Indication</b>	<b>Dose and duration of therapy</b> (See section 5.2)
Treatment of invasive aspergillosis (only for adults)	Loading dose of 300 mg (three 100 mg tablets or 300 mg concentrate for solution for infusion) twice a day on the first day, then 300 mg (three 100 mg tablets or 300 mg concentrate for solution for infusion) once a day thereafter. Each tablet dose may be taken without regard to food intake. Recommended total duration of therapy is 6-12 weeks. Switching between intravenous and oral administration is appropriate when clinically indicated.
Refractory invasive fungal infections (IFI)/patients with IFI intolerant to 1 <sup>st</sup> line therapy	Loading dose of 300 mg (three 100 mg tablets) twice a day on the first day, then 300 mg (three 100 mg tablets) once a day thereafter. Each dose may be taken without regard to food intake. Duration of therapy should be based on the severity of the underlying disease, recovery from immunosuppression, and clinical response.
Prophylaxis of invasive fungal infections	Loading dose of 300 mg (three 100 mg tablets) twice a day on the first day, then 300 mg (three 100 mg tablets) once a day thereafter. Each dose may be taken without regard to food intake. Duration of therapy is based on recovery from neutropenia or immunosuppression. For patients with acute myelogenous leukaemia or myelodysplastic syndromes, prophylaxis with Noxafil should start several days before the anticipated onset of neutropenia and continue for 7 days after the neutrophil count rises above 500 cells per mm <sup>3</sup> .

## Special populations

### *Renal impairment*

An effect of renal impairment on the pharmacokinetics of posaconazole is not expected and no dose adjustment is recommended (see section 5.2).

### *Hepatic impairment*

Limited data on the effect of hepatic impairment (including Child-Pugh C classification of chronic liver disease) on the pharmacokinetics of posaconazole demonstrate an increase in plasma exposure compared to subjects with normal hepatic function, but do not suggest that dose adjustment is necessary (see sections 4.4 and 5.2). It is recommended to exercise caution due to the potential for higher plasma exposure.

### *Paediatric population*

The safety and efficacy of posaconazole in children aged below 2 years have not been established. No clinical data are available.

## Method of administration

For oral use

Noxafil gastro-resistant tablets may be taken with or without food (see section 5.2). The tablets should be swallowed whole with water and should not be crushed, chewed, or broken.

## **4.3 Contraindications**

Hypersensitivity to the active substance or to any of the excipients listed in section 6.1.

Co-administration with ergot alkaloids (see section 4.5).

Co-administration with the CYP3A4 substrates terfenadine, astemizole, cisapride, pimozone, halofantrine or quinidine since this may result in increased plasma concentrations of these medicinal products, leading to QTc prolongation and rare occurrences of torsades de pointes (see sections 4.4 and 4.5).

Co-administration with the HMG-CoA reductase inhibitors simvastatin, lovastatin and atorvastatin (see section 4.5).

Co-administration during the initiation and dose-titration phase of venetoclax in Chronic Lymphocytic Leukaemia (CLL) patients (see sections 4.4 and 4.5).

## **4.4 Special warnings and precautions for use**

### Hypersensitivity

There is no information regarding cross-sensitivity between posaconazole and other azole antifungal agents. Caution should be used when prescribing posaconazole to patients with hypersensitivity to other azoles.

### Hepatic toxicity

Hepatic reactions (e.g. mild to moderate elevations in ALT, AST, alkaline phosphatase, total bilirubin and/or clinical hepatitis) have been reported during treatment with posaconazole. Elevated liver function tests were generally reversible on discontinuation of therapy and in some instances these tests normalised without interruption of therapy. Rarely, more severe hepatic reactions with fatal outcomes have been reported.

Posaconazole should be used with caution in patients with hepatic impairment due to limited clinical experience and the possibility that posaconazole plasma levels may be higher in these patients (see sections 4.2 and 5.2).

### Monitoring of hepatic function

Liver function tests should be evaluated at the start of and during the course of posaconazole therapy. Patients who develop abnormal liver function tests during posaconazole therapy must be routinely monitored for the development of more severe hepatic injury. Patient management should include laboratory evaluation of hepatic function (particularly liver function tests and bilirubin).

Discontinuation of posaconazole should be considered if clinical signs and symptoms are consistent with development of liver disease.

### QTc prolongation

Some azoles have been associated with prolongation of the QTc interval. Posaconazole must not be administered with medicinal products that are substrates for CYP3A4 and are known to prolong the QTc interval (see sections 4.3 and 4.5). Posaconazole should be administered with caution to patients with pro-arrhythmic conditions such as:

- Congenital or acquired QTc prolongation
- Cardiomyopathy, especially in the presence of cardiac failure
- Sinus bradycardia
- Existing symptomatic arrhythmias
- Concomitant use with medicinal products known to prolong the QTc interval (other than those mentioned in section 4.3).

Electrolyte disturbances, especially those involving potassium, magnesium or calcium levels, should be monitored and corrected as necessary before and during posaconazole therapy.

### Drug interactions

Posaconazole is an inhibitor of CYP3A4 and should only be used under specific circumstances during treatment with other medicinal products that are metabolised by CYP3A4 (see section 4.5).

### Midazolam and other benzodiazepines

Due to the risk of prolonged sedation and possible respiratory depression co-administration of posaconazole with any benzodiazepines metabolised by CYP3A4 (e.g. midazolam, triazolam, alprazolam) should only be considered if clearly necessary. Dose adjustment of benzodiazepines metabolised by CYP3A4 should be considered (see section 4.5).

### Vincristine toxicity

Concomitant administration of azole antifungals, including posaconazole, with vincristine has been associated with neurotoxicity and other serious adverse reactions, including seizures, peripheral neuropathy, syndrome of inappropriate antidiuretic hormone secretion, and paralytic ileus. Reserve azole antifungals, including posaconazole, for patients receiving a vinca alkaloid, including vincristine, who have no alternative antifungal treatment options (see section 4.5).

### Venetoclax toxicity

Concomitant administration of strong CYP3A inhibitors, including posaconazole, with the CYP3A4 substrate venetoclax, may increase venetoclax toxicities, including the risk of tumour lysis syndrome (TLS) and neutropenia (see sections 4.3 and 4.5). Refer to the venetoclax SmPC for detailed guidance.

### Rifamycin antibacterials (rifampicin, rifabutin), certain anticonvulsants (phenytoin, carbamazepine, phenobarbital, primidone), and efavirenz.

Posaconazole concentrations may be significantly lowered in combination; therefore, concomitant use with posaconazole should be avoided unless the benefit to the patient outweighs the risk (see section 4.5).

### Plasma exposure

Posaconazole plasma concentrations following administration of posaconazole tablets are generally higher than those obtained with posaconazole oral suspension. Posaconazole plasma concentrations following administration of posaconazole tablets may increase over time in some patients (see section 5.2).



### Gastrointestinal dysfunction

There are limited pharmacokinetic data in patients with severe gastrointestinal dysfunction (such as severe diarrhoea). Patients who have severe diarrhoea or vomiting should be monitored closely for breakthrough fungal infections.

### Sodium

This medicinal product contains less than 1 mmol sodium (23 mg) per tablet, that is to say essentially 'sodium-free'.

## **4.5 Interaction with other medicinal products and other forms of interaction**

### Effects of other medicinal products on posaconazole

Posaconazole is metabolised via UDP glucuronidation (phase 2 enzymes) and is a substrate for p-glycoprotein (P-gp) efflux *in vitro*. Therefore, inhibitors (e.g. verapamil, ciclosporin, quinidine, clarithromycin, erythromycin, etc.) or inducers (e.g. rifampicin, rifabutin, certain anticonvulsants, etc.) of these clearance pathways may increase or decrease posaconazole plasma concentrations, respectively.

#### *Rifabutin*

Rifabutin (300 mg once a day) decreased the  $C_{max}$  (maximum plasma concentration) and AUC (area under the plasma concentration time curve) of posaconazole to 57 % and 51 %, respectively. Concomitant use of posaconazole and rifabutin and similar inducers (e.g. rifampicin) should be avoided unless the benefit to the patient outweighs the risk. See also below regarding the effect of posaconazole on rifabutin plasma levels.

#### *Efavirenz*

Efavirenz (400 mg once a day) decreased the  $C_{max}$  and AUC of posaconazole by 45 % and 50 %, respectively. Concomitant use of posaconazole and efavirenz should be avoided unless the benefit to the patient outweighs the risk.

#### *Fosamprenavir*

Combining fosamprenavir with posaconazole may lead to decreased posaconazole plasma concentrations. If concomitant administration is required, close monitoring for breakthrough fungal infections is recommended. Repeat dose administration of fosamprenavir (700 mg twice daily x 10 days) decreased the  $C_{max}$  and AUC of posaconazole oral suspension (200 mg once daily on the 1<sup>st</sup> day, 200 mg twice daily on the 2<sup>nd</sup> day, then 400 mg twice daily x 8 Days) by 21 % and 23 %, respectively. The effect of posaconazole on fosamprenavir levels when fosamprenavir is given with ritonavir is unknown.

#### *Phenytoin*

Phenytoin (200 mg once a day) decreased the  $C_{max}$  and AUC of posaconazole by 41 % and 50 %, respectively. Concomitant use of posaconazole and phenytoin and similar inducers (e.g. carbamazepine, phenobarbital, primidone) should be avoided unless the benefit to the patient outweighs the risk.

#### *H<sub>2</sub> receptor antagonists and proton pump inhibitors*

No clinically relevant effects were observed when posaconazole tablets are concomitantly used with antacids, H<sub>2</sub>-receptor antagonists and proton pump inhibitors. No dose adjustment of posaconazole tablets is required when posaconazole tablets are concomitantly used with antacids, H<sub>2</sub>-receptor antagonists and proton pump inhibitors.

### Effects of posaconazole on other medicinal products

Posaconazole is a potent inhibitor of CYP3A4. Co-administration of posaconazole with CYP3A4 substrates may result in large increases in exposure to CYP3A4 substrates as exemplified by the effects on tacrolimus, sirolimus, atazanavir and midazolam below. Caution is advised during co-administration of posaconazole with CYP3A4 substrates administered intravenously and the dose of the CYP3A4 substrate may need to be reduced. If posaconazole is used concomitantly with CYP3A4

substrates that are administered orally, and for which an increase in plasma concentrations may be associated with unacceptable adverse reactions, plasma concentrations of the CYP3A4 substrate and/or adverse reactions should be closely monitored and the dose adjusted as needed. Several of the interaction studies were conducted in healthy volunteers in whom a higher exposure to posaconazole occurs compared to patients administered the same dose. The effect of posaconazole on CYP3A4 substrates in patients might be somewhat lower than that observed in healthy volunteers, and is expected to be variable between patients due to the variable posaconazole exposure in patients. The effect of co-administration with posaconazole on plasma levels of CYP3A4 substrates may also be variable within a patient.

*Terfenadine, astemizole, cisapride, pimozone, halofantrine and quinidine (CYP3A4 substrates)*

Co-administration of posaconazole and terfenadine, astemizole, cisapride, pimozone, halofantrine or quinidine is contraindicated. Co-administration may result in increased plasma concentrations of these medicinal products, leading to QTc prolongation and rare occurrences of torsades de pointes (see section 4.3).

*Ergot alkaloids*

Posaconazole may increase the plasma concentration of ergot alkaloids (ergotamine and dihydroergotamine), which may lead to ergotism. Co-administration of posaconazole and ergot alkaloids is contraindicated (see section 4.3).

*HMG-CoA reductase inhibitors metabolised through CYP3A4 (e.g. simvastatin, lovastatin, and atorvastatin)*

Posaconazole may substantially increase plasma levels of HMG-CoA reductase inhibitors that are metabolised by CYP3A4. Treatment with these HMG-CoA reductase inhibitors should be discontinued during treatment with posaconazole as increased levels have been associated with rhabdomyolysis (see section 4.3).

*Vinca alkaloids*

Most of the vinca alkaloids (e.g. vincristine and vinblastine) are substrates of CYP3A4. Concomitant administration of azole antifungals, including posaconazole, with vincristine has been associated with serious adverse reactions (see section 4.4). Posaconazole may increase the plasma concentrations of vinca alkaloids which may lead to neurotoxicity and other serious adverse reactions. Therefore, reserve azole antifungals, including posaconazole, for patients receiving a vinca alkaloid, including vincristine, who have no alternative antifungal treatment options.

*Rifabutin*

Posaconazole increased the  $C_{max}$  and AUC of rifabutin by 31 % and 72 %, respectively. Concomitant use of posaconazole and rifabutin should be avoided unless the benefit to the patient outweighs the risk (see also above regarding the effect of rifabutin on plasma levels of posaconazole). If these medicinal products are co-administered, careful monitoring of full blood counts and adverse reactions related to increased rifabutin levels (e.g. uveitis) is recommended.

*Sirolimus*

Repeat dose administration of posaconazole oral suspension (400 mg twice daily for 16 days) increased the  $C_{max}$  and AUC of sirolimus (2 mg single dose) an average of 6.7-fold and 8.9-fold (range 3.1 to 17.5-fold), respectively, in healthy subjects. The effect of posaconazole on sirolimus in patients is unknown, but is expected to be variable due to the variable posaconazole exposure in patients. Co-administration of posaconazole with sirolimus is not recommended and should be avoided whenever possible. If it is considered that co-administration is unavoidable, then it is recommended that the dose of sirolimus should be greatly reduced at the time of initiation of posaconazole therapy and that there should be very frequent monitoring of trough concentrations of sirolimus in whole blood. Sirolimus concentrations should be measured upon initiation, during co-administration, and at discontinuation of posaconazole treatment, with sirolimus doses adjusted accordingly. It should be noted that the relationship between sirolimus trough concentration and AUC is changed during co-administration with posaconazole. As a result, sirolimus trough concentrations that fall within the usual therapeutic range may result in sub-therapeutic levels. Therefore, trough concentrations that fall in the upper part

of the usual therapeutic range should be targeted and careful attention should be paid to clinical signs and symptoms, laboratory parameters and tissue biopsies.

#### *Ciclosporin*

In heart transplant patients on stable doses of ciclosporin, posaconazole oral suspension 200 mg once daily increased ciclosporin concentrations requiring dose reductions. Cases of elevated ciclosporin levels resulting in serious adverse reactions, including nephrotoxicity and one fatal case of leukoencephalopathy, were reported in clinical efficacy studies. When initiating treatment with posaconazole in patients already receiving ciclosporin, the dose of ciclosporin should be reduced (e.g. to about three quarters of the current dose). Thereafter blood levels of ciclosporin should be monitored carefully during co-administration, and upon discontinuation of posaconazole treatment, and the dose of ciclosporin should be adjusted as necessary.

#### *Tacrolimus*

Posaconazole increased  $C_{max}$  and AUC of tacrolimus (0.05 mg/kg body weight single dose) by 121 % and 358 %, respectively. Clinically significant interactions resulting in hospitalisation and/or posaconazole discontinuation were reported in clinical efficacy studies. When initiating posaconazole treatment in patients already receiving tacrolimus, the dose of tacrolimus should be reduced (e.g. to about one third of the current dose). Thereafter blood levels of tacrolimus should be monitored carefully during co-administration, and upon discontinuation of posaconazole, and the dose of tacrolimus should be adjusted as necessary.

#### *HIV Protease inhibitors*

As HIV protease inhibitors are CYP3A4 substrates, it is expected that posaconazole will increase plasma levels of these antiretroviral agents. Following co-administration of posaconazole oral suspension (400 mg twice daily) with atazanavir (300 mg once daily) for 7 days in healthy subjects  $C_{max}$  and AUC of atazanavir increased by an average of 2.6-fold and 3.7-fold (range 1.2 to 26-fold), respectively. Following co-administration of posaconazole oral suspension (400 mg twice daily) with atazanavir and ritonavir (300/100 mg once daily) for 7 days in healthy subjects  $C_{max}$  and AUC of atazanavir increased by an average of 1.5-fold and 2.5-fold (range 0.9 to 4.1-fold), respectively. The addition of posaconazole to therapy with atazanavir or with atazanavir plus ritonavir was associated with increases in plasma bilirubin levels. Frequent monitoring for adverse reactions and toxicity related to antiretroviral agents that are substrates of CYP3A4 is recommended during co-administration with posaconazole.

#### *Midazolam and other benzodiazepines metabolised by CYP3A4*

In a study in healthy volunteers posaconazole oral suspension (200 mg once daily for 10 days) increased the exposure (AUC) of intravenous midazolam (0.05 mg/kg) by 83 %. In another study in healthy volunteers, repeat dose administration of posaconazole oral suspension (200 mg twice daily for 7 days) increased the  $C_{max}$  and AUC of intravenous midazolam (0.4 mg single dose) by an average of 1.3- and 4.6-fold (range 1.7 to 6.4-fold), respectively; Posaconazole oral suspension 400 mg twice daily for 7 days increased the intravenous midazolam  $C_{max}$  and AUC by 1.6 and 6.2-fold (range 1.6 to 7.6-fold), respectively. Both doses of posaconazole increased  $C_{max}$  and AUC of oral midazolam (2 mg single oral dose) by 2.2 and 4.5-fold, respectively. In addition, posaconazole oral suspension (200 mg or 400 mg) prolonged the mean terminal half-life of midazolam from approximately 3-4 hours to 8-10 hours during co-administration.

Due to the risk of prolonged sedation it is recommended that dose adjustments should be considered when posaconazole is administered concomitantly with any benzodiazepine that is metabolised by CYP3A4 (e.g. midazolam, triazolam, alprazolam) (see section 4.4).

#### *Calcium channel blockers metabolised through CYP3A4 (e.g. diltiazem, verapamil, nifedipine, nisoldipine)*

Frequent monitoring for adverse reactions and toxicity related to calcium channel blockers is recommended during co-administration with posaconazole. Dose adjustment of calcium channel blockers may be required.

### *Digoxin*

Administration of other azoles has been associated with increases in digoxin levels. Therefore, posaconazole may increase plasma concentration of digoxin and digoxin levels need to be monitored when initiating or discontinuing posaconazole treatment.

### *Sulfonylureas*

Glucose concentrations decreased in some healthy volunteers when glipizide was co-administered with posaconazole. Monitoring of glucose concentrations is recommended in diabetic patients.

### *All-trans retinoic acid (ATRA) or tretinoin*

As ATRA is metabolised by the hepatic CYP450 enzymes, notably CYP3A4, concomitant administration with posaconazole, which is a strong inhibitor of CYP3A4, may lead to increased exposure to tretinoin resulting in an increased toxicity (especially hypercalcaemia). Serum calcium levels should be monitored and, if needed, appropriate dose adjustments of tretinoin should be considered during the treatment with posaconazole, and during the following days after treatment.

### *Venetoclax*

Compared with venetoclax 400 mg administered alone, co-administration of 300 mg posaconazole, a strong CYP3A inhibitor, with venetoclax 50 mg and 100 mg for 7 days in 12 patients, increased venetoclax  $C_{max}$  to 1.6-fold and 1.9-fold, and AUC to 1.9-fold and 2.4-fold, respectively (see sections 4.3 and 4.4).

Refer to the venetoclax SmPC.

### Paediatric population

Interaction studies have only been performed in adults.

## **4.6 Fertility, pregnancy and lactation**

### Pregnancy

There is insufficient information on the use of posaconazole in pregnant women. Studies in animals have shown reproductive toxicity (see section 5.3). The potential risk for humans is unknown.

Women of childbearing potential have to use effective contraception during treatment. Posaconazole must not be used during pregnancy unless the benefit to the mother clearly outweighs the potential risk to the foetus.

### Breast-feeding

Posaconazole is excreted into the milk of lactating rats (see section 5.3). The excretion of posaconazole in human breast milk has not been investigated. Breast-feeding must be stopped on initiation of treatment with posaconazole.

### Fertility

Posaconazole had no effect on fertility of male rats at doses up to 180 mg/kg (3.4 times the 300-mg tablet based on steady-state plasma concentrations in patients) or female rats at a dose up to 45 mg/kg (2.6 times the 300-mg tablet based on steady-state plasma concentrations in patients). There is no clinical experience assessing the impact of posaconazole on fertility in humans.

## **4.7 Effects on ability to drive and use machines**

Since certain adverse reactions (e.g. dizziness, somnolence, etc.) have been reported with posaconazole use, which potentially may affect driving/operating machinery, caution needs to be used.

## **4.8 Undesirable effects**

### Summary of the safety profile

Safety data mainly derive from studies with the oral suspension.

The safety of posaconazole oral suspension has been assessed in > 2,400 patients and healthy volunteers enrolled in clinical studies and from post-marketing experience. The most frequently reported serious related adverse reactions included nausea, vomiting, diarrhoea, pyrexia, and increased bilirubin.

Posaconazole tablets

The safety of posaconazole tablet has been assessed in 104 healthy volunteers and 230 patients enrolled in a clinical study of antifungal prophylaxis.

The safety of posaconazole concentrate for solution for infusion and posaconazole tablet has been assessed in 288 patients enrolled in a clinical study of aspergillosis of whom 161 patients received the concentrate for solution for infusion and 127 patients received the tablet formulation.

The tablet formulation was investigated in AML and MDS patients and those after HSCT with or at risk for Graft versus Host Disease (GVHD) only. Maximum duration of exposure to the tablet formulation was shorter than with the oral suspension. Plasma exposure resulting from the tablet formulation was higher than observed with the oral suspension.

The safety of posaconazole tablets has been assessed in 230 patients enrolled in the pivotal clinical study. Patients were enrolled in a non-comparative pharmacokinetic and safety study of posaconazole tablets when given as antifungal prophylaxis. Patients were immunocompromised with underlying conditions including haematological malignancy, neutropenia post-chemotherapy, GVHD, and post HSCT. Posaconazole therapy was given for a median duration of 28 days. Twenty patients received 200 mg daily dose and 210 patients received 300 mg daily dose (following twice daily dosing on Day 1 in each cohort).

The safety of posaconazole tablets and concentrate for solution for infusion were also investigated in a controlled study of treatment of invasive aspergillosis. The maximum duration of invasive aspergillosis treatment was similar to that studied with the oral suspension for salvage treatment and was longer than that with the tablets or concentrate for solution for infusion in prophylaxis.

Tabulated list of adverse reactions

Within the organ system classes, adverse reactions are listed under headings of frequency using the following categories: very common ( $\geq 1/10$ ); common ( $\geq 1/100$  to  $< 1/10$ ); uncommon ( $\geq 1/1,000$  to  $< 1/100$ ); rare ( $\geq 1/10,000$  to  $< 1/1,000$ ); very rare ( $< 1/10,000$ ); not known (cannot be estimated from the available data).

**Table 2.** Adverse reactions by body system and frequency reported in clinical studies and/or post-marketing use\*

<b>Blood and lymphatic system disorders</b>	
Common:	neutropenia
Uncommon:	thrombocytopenia, leukopenia, anaemia, eosinophilia, lymphadenopathy, splenic infarction
Rare:	haemolytic uraemic syndrome, thrombotic thrombocytopenic purpura, pancytopenia, coagulopathy, haemorrhage
<b>Immune system disorders</b>	
Uncommon:	allergic reaction
Rare:	hypersensitivity reaction
<b>Endocrine disorders</b>	
Rare:	adrenal insufficiency, blood gonadotropin decreased, pseudoaldosteronism
<b>Metabolism and nutrition disorders</b>	
Common:	electrolyte imbalance, anorexia, decreased appetite, hypokalaemia, hypomagnesaemia
Uncommon:	hyperglycaemia, hypoglycaemia

<b>Psychiatric disorders</b> Uncommon: Rare:	abnormal dreams, confusional state, sleep disorder psychotic disorder, depression
<b>Nervous system disorders</b> Common: Uncommon: Rare:	paraesthesia, dizziness, somnolence, headache, dysgeusia convulsions, neuropathy, hypoaesthesia, tremor, aphasia, insomnia cerebrovascular accident, encephalopathy, peripheral neuropathy, syncope
<b>Eye disorders</b> Uncommon: Rare:	blurred vision, photophobia, visual acuity reduced diplopia, scotoma
<b>Ear and labyrinth disorder</b> Rare:	hearing impairment
<b>Cardiac disorders</b> Uncommon: Rare:	long QT syndrome <sup>§</sup> , electrocardiogram abnormal <sup>§</sup> , palpitations, bradycardia, supraventricular extrasystoles, tachycardia torsade de pointes, sudden death, ventricular tachycardia, cardio-respiratory arrest, cardiac failure, myocardial infarction
<b>Vascular disorders</b> Common: Uncommon: Rare:	hypertension hypotension, vasculitis pulmonary embolism, deep vein thrombosis
<b>Respiratory, thoracic and mediastinal disorders</b> Uncommon: Rare:	cough, epistaxis, hiccups, nasal congestion, pleuritic pain, tachypnoea pulmonary hypertension, interstitial pneumonia, pneumonitis
<b>Gastrointestinal disorders</b> Very Common: Common: Uncommon: Rare:	nausea vomiting, abdominal pain, diarrhoea, dyspepsia, dry mouth, flatulence, constipation, anorectal discomfort pancreatitis, abdominal distension, enteritis, epigastric discomfort, eructation, gastroesophageal reflux disease, oedema mouth gastrointestinal haemorrhage, ileus
<b>Hepatobiliary disorders</b> Common: Uncommon: Rare:	liver function tests raised (ALT increased, AST increased, bilirubin increased, alkaline phosphatase increased, GGT increased) hepatocellular damage, hepatitis, jaundice, hepatomegaly, cholestasis, hepatic toxicity, hepatic function abnormal hepatic failure, hepatitis cholestatic, hepatosplenomegaly, liver tenderness, asterixis
<b>Skin and subcutaneous tissue disorders</b> Common: Uncommon: Rare:	rash, pruritis mouth ulceration, alopecia, dermatitis, erythema, petechiae Stevens Johnson syndrome, vesicular rash
<b>Musculoskeletal and connective tissue disorders</b> Uncommon:	back pain, neck pain, musculoskeletal pain, pain in extremity

<b>Renal and urinary disorders</b>	
Uncommon:	acute renal failure, renal failure, blood creatinine increased
Rare:	renal tubular acidosis, interstitial nephritis
<b>Reproductive system and breast disorders</b>	
Uncommon:	menstrual disorder
Rare:	breast pain
<b>General disorders and administration site conditions</b>	
Common:	pyrexia (fever), asthenia, fatigue
Uncommon:	oedema, pain, chills, malaise, chest discomfort, drug intolerance, feeling jittery, mucosal inflammation
Rare:	tongue oedema, face oedema
<b>Investigations</b>	
Uncommon:	altered medicine levels, blood phosphorus decreased, chest x-ray abnormal

\* Based on adverse reactions observed with the oral suspension, gastro-resistant tablets, concentrate for solution for infusion, and gastro-resistant powder and solvent for oral suspension.

§ See section 4.4.

### Description of selected adverse reactions

#### *Hepatobiliary disorders*

During post-marketing surveillance of posaconazole oral suspension, severe hepatic injury with fatal outcome has been reported (see section 4.4).

### Reporting of suspected adverse reactions

Reporting suspected adverse reactions after authorisation of the medicinal product is important. It allows continued monitoring of the benefit/risk balance of the medicinal product. Healthcare professionals are asked to report any suspected adverse reactions via **the national reporting system** listed in [Appendix V](#).

## **4.9 Overdose**

There is no experience with overdose of posaconazole tablets.

During clinical studies, patients who received posaconazole oral suspension doses up to 1,600 mg/day experienced no different adverse reactions from those reported with patients at the lower doses.

Accidental overdose was noted in one patient who took posaconazole oral suspension 1,200 mg twice a day for 3 days. No adverse reactions were noted by the investigator.

Posaconazole is not removed by haemodialysis. There is no special treatment available in the case of overdose with posaconazole. Supportive care may be considered.

## **5. PHARMACOLOGICAL PROPERTIES**

### **5.1 Pharmacodynamic properties**

Pharmacotherapeutic group: Antimycotics for systemic use, triazole derivatives, ATC code: J02AC04.

#### Mechanism of action

Posaconazole inhibits the enzyme lanosterol 14 $\alpha$ -demethylase (CYP51), which catalyses an essential step in ergosterol biosynthesis.

#### Microbiology

Posaconazole has been shown *in vitro* to be active against the following microorganisms: *Aspergillus* species (*Aspergillus fumigatus*, *A. flavus*, *A. terreus*, *A. nidulans*, *A. niger*, *A. ustus*), *Candida* species

(*Candida albicans*, *C. glabrata*, *C. krusei*, *C. parapsilosis*, *C. tropicalis*, *C. dubliniensis*, *C. famata*, *C. inconspicua*, *C. lipolytica*, *C. norvegensis*, *C. pseudotropicalis*), *Coccidioides immitis*, *Fonsecaea pedrosoi*, and species of *Fusarium*, *Rhizomucor*, *Mucor*, and *Rhizopus*. The microbiological data suggest that posaconazole is active against *Rhizomucor*, *Mucor*, and *Rhizopus*; however, the clinical data are currently too limited to assess the efficacy of posaconazole against these causative agents.

The following *in vitro* data are available, but their clinical significance is unknown. In a surveillance study of > 3,000 clinical mold isolates from 2010-2018, 90 % of non-*Aspergillus* fungi exhibited the following *in vitro* minimum inhibitory concentration (MIC): *Mucorales* spp (n=81) of 2 mg/L; *Scedosporium apiospermum*/*S. boydii* (n=65) of 2 mg/L; *Exophiala dermatitidis* (n=15) of 0.5 mg/L, and *Purpureocillium lilacinum* (n=21) of 1 mg/L.

### Resistance

Clinical isolates with decreased susceptibility to posaconazole have been identified. The principle mechanism of resistance is the acquisition of substitutions in the target protein, CYP51.

### Epidemiological Cut-off (ECOFF) Values for *Aspergillus* spp.

The ECOFF values for posaconazole, which distinguish the wild type population from isolates with acquired resistance, have been determined by EUCAST methodology.

EUCAST ECOFF values:

- *Aspergillus flavus*: 0.5 mg/L
- *Aspergillus fumigatus*: 0.5 mg/L
- *Aspergillus nidulans*: 0.5 mg/L
- *Aspergillus niger*: 0.5 mg/L
- *Aspergillus terreus*: 0.25 mg/L

There are currently insufficient data to set clinical breakpoints for *Aspergillus* spp. ECOFF values do not equate to clinical breakpoints.

### Breakpoints

EUCAST MIC breakpoints for posaconazole [susceptible (S); resistant (R)]:

- *Candida albicans*: S ≤0.06 mg/L, R >0.06 mg/L
- *Candida tropicalis*: S ≤0.06 mg/L, R >0.06 mg/L
- *Candida parapsilosis*: S ≤0.06 mg/L, R >0.06 mg/L
- *Candida dubliniensis*: S ≤0.06 mg/L, R > 0.06 mg/L

There are currently insufficient data to set clinical breakpoints for other *Candida* species.

### Combination with other antifungal agents

The use of combination antifungal therapies should not decrease the efficacy of either posaconazole or the other therapies; however, there is currently no clinical evidence that combination therapy will provide an added benefit.

### Clinical experience

#### Summary of posaconazole concentrate for solution for infusion and tablet study invasive aspergillosis

The safety and efficacy of posaconazole for the treatment of patients with invasive aspergillosis was evaluated in a double-blind controlled study (study-69) in 575 patients with proven, probable, or possible invasive fungal infections per EORTC/MSG criteria.

Patients were treated with posaconazole (n=288) concentrate for solution for infusion or tablet given at a dose of 300 mg QD (BID on Day 1). Comparator patients were treated with voriconazole (n=287) given IV at a dose of 6 mg/kg BID Day 1 followed by 4 mg/kg BID, or orally at a dose of 300 mg BID Day 1 followed by 200 mg BID. Median treatment duration was 67 days (posaconazole) and 64 days (voriconazole).



In the intent-to-treat (ITT) population (all subjects who received at least one dose of study drug), 288 patients received posaconazole and 287 patients received voriconazole. The full analysis set population (FAS) is the subset of all subjects within the ITT population who were classified by independent adjudication as having proven or probable invasive aspergillosis: 163 subjects for posaconazole and 171 subjects for voriconazole. The all-cause mortality and global clinical response in these two populations are presented in Table 3 and 4, respectively.

**Table 3.** Posaconazole invasive aspergillosis treatment study 1: all-cause mortality at Day 42 and Day 84, in the ITT and FAS populations

Population	Posaconazole		Voriconazole		Difference* (95 % CI)
	N	n (%)	N	n (%)	
Mortality in ITT at Day 42	288	44 (15.3)	287	59 (20.6)	-5.3 % (-11.6, 1.0)
Mortality in ITT at Day 84	288	81 (28.1)	287	88 (30.7)	-2.5 % (-9.9, 4.9)
Mortality in FAS at Day 42	163	31 (19.0)	171	32 (18.7)	0.3% (-8.2, 8.8)
Mortality in FAS at Day 84	163	56 (34.4)	171	53 (31.0)	3.1% (-6.9, 13.1)

\* Adjusted treatment difference based on Miettinen and Nurminen's method stratified by randomisation factor (risk for mortality/poor outcome), using Cochran-Mantel-Haenszel weighting scheme.

**Table 4.** Posaconazole invasive aspergillosis treatment study 1: global clinical response at Week 6 and Week 12 in the FAS population

Population	Posaconazole		Voriconazole		Difference* (95 % CI)
	N	Success (%)	N	Success (%)	
Global clinical response in the FAS at 6 weeks	163	73 (44.8)	171	78 (45.6)	-0.6 % (-11.2, 10.1)
Global clinical response in the FAS at 12 weeks	163	69 (42.3)	171	79 (46.2)	-3.4 % (-13.9, 7.1)

\* Successful Global Clinical Response was defined as survival with a partial or complete response  
Adjusted treatment difference based on Miettinen and Nurminen's method stratified by randomisation factor (risk for mortality/poor outcome), using Cochran-Mantel-Haenszel weighting scheme.

Summary of posaconazole tablet bridging study

Study 5615 was a non-comparative multi-centre study performed to evaluate the pharmacokinetic properties, safety, and tolerability of posaconazole tablet. Study 5615 was conducted in a similar patient population to that previously studied in the pivotal posaconazole oral suspension clinical program. The pharmacokinetics and safety data from Study 5615 were bridged to the existing data (including efficacy data) with the oral suspension.

The subject population included: 1) patients with AML or MDS who had recently received chemotherapy and had developed or were anticipated to develop significant neutropenia, or 2) patients who had undergone a HSCT and were receiving immunosuppressive therapy for prevention or treatment of GVHD. Two different dosing groups were evaluated: 200 mg twice daily on Day 1, followed by 200 mg once daily thereafter (Part IA) and 300 mg twice daily on Day 1, followed by 300 mg once daily thereafter (Part 1B and Part 2).

Serial PK samples were collected on Day 1 and at steady-state on Day 8 for all Part 1 subjects and a subset of Part 2 subjects. Moreover, sparse PK samples were collected at several days during steady state before the next dose ( $C_{min}$ ) for a larger subject population. Based on average  $C_{min}$  concentrations, a predicted average concentration ( $C_{av}$ ) could be calculated for 186 subjects dosed with 300 mg. PK analysis in patients of  $C_{av}$  found that 81 % of the subjects treated with the 300 mg once daily dose attained steady state predicted  $C_{av}$  between 500-2,500 ng/mL. One subject (<1 %) had a predicted  $C_{av}$

below 500 ng/mL and 19 % of the subjects had a predicted  $C_{av}$  above 2,500 ng/mL. Subjects achieved a mean predicted  $C_{av}$  at steady state of 1,970 ng/mL.

In Table 5 a comparison is shown of exposure ( $C_{av}$ ) after administration of posaconazole tablet and posaconazole oral suspension at therapeutic doses in patients depicted as quartile analysis. Exposures after tablet administration are generally higher than, but overlapping with, exposures after administration of posaconazole oral suspension.

**Table 5.**  $C_{av}$  quartile analyses of pivotal patient studies with posaconazole tablet and oral suspension

	<b>Posaconazole tablet</b>	<b>Posaconazole oral suspension</b>		
	<b>Prophylaxis in AML and HSCT Study 5615</b>	<b>Prophylaxis in GVHD Study 316</b>	<b>Prophylaxis in Neutropenia Study 1899</b>	<b>Treatment – Invasive Aspergillosis Study 0041</b>
	<b>300 mg once daily (Day 1 300 mg twice daily)*</b>	<b>200 mg three times daily</b>	<b>200 mg three times daily</b>	<b>200 mg four times daily (hospitalized) then 400 mg twice daily</b>
<b>Quartile</b>	<b><math>pC_{av}</math> Range (ng/mL)</b>	<b><math>C_{av}</math> Range (ng/mL)</b>	<b><math>C_{av}</math> Range (ng/mL)</b>	<b><math>C_{av}</math> Range (ng/mL)</b>
<b>Q1</b>	442 – 1,223	22 – 557	90 – 322	55 – 277
<b>Q2</b>	1,240 – 1,710	557 – 915	322 – 490	290 – 544
<b>Q3</b>	1,719 – 2,291	915 – 1,563	490 – 734	550 – 861
<b>Q4</b>	2,304 – 9,523	1,563 – 3,650	734 – 2,200	877 – 2,010
<p><math>pC_{av}</math>: predicted <math>C_{av}</math>  <math>C_{av}</math> = the average concentration when measured at steady state            *20 patients received 200 mg once daily (Day 1 200 mg twice daily)</p>				

Summary of posaconazole oral suspension studies

*Invasive aspergillosis*

Oral posaconazole suspension 800 mg/day in divided doses was evaluated for the treatment of invasive aspergillosis in patients with disease refractory to amphotericin B (including liposomal formulations) or itraconazole or in patients who were intolerant of these medicinal products in a non-comparative salvage therapy study (Study 0041). Clinical outcomes were compared with those in an external control group derived from a retrospective review of medical records. The external control group included 86 patients treated with available therapy (as above) mostly at the same time and at the same sites as the patients treated with posaconazole. Most of the cases of aspergillosis were considered to be refractory to prior therapy in both the posaconazole group (88 %) and in the external control group (79 %).

As shown in Table 6, a successful response (complete or partial resolution) at the end of treatment was seen in 42 % of posaconazole-treated patients compared to 26 % of the external group. However, this was not a prospective, randomised controlled study and so all comparisons with the external control group should be viewed with caution.

**Table 6.** Overall efficacy of posaconazole oral suspension at the end of treatment for invasive aspergillosis in comparison to an external control group

	<b>Posaconazole oral suspension</b>	<b>External control group</b>
Overall Response	45/107 (42 %)	22/86 (26 %)
<b>Success by Species</b>		
All mycologically confirmed <i>Aspergillus</i> spp. <sup>2</sup>	34/76 (45 %)	19/74 (26 %)
<i>A. fumigatus</i>	12/29 (41 %)	12/34 (35 %)
<i>A. flavus</i>	10/19 (53 %)	3/16 (19 %)
<i>A. terreus</i>	4/14 (29 %)	2/13 (15 %)
<i>A. niger</i>	3/5 (60 %)	2/7 (29 %)

#### *Fusarium* spp.

11 of 24 patients who had proven or probable fusariosis were successfully treated with posaconazole oral suspension 800 mg/day in divided doses for a median of 124 days and up to 212 days. Among eighteen patients who were intolerant or had infections refractory to amphotericin B or itraconazole, seven patients were classed as responders.

#### *Chromoblastomycosis/Mycetoma*

9 of 11 patients were successfully treated with posaconazole oral suspension 800 mg/day in divided doses for a median of 268 days and up to 377 days. Five of these patients had chromoblastomycosis due to *Fonsecaea pedrosoi* and 4 had mycetoma, mostly due to *Madurella* species.

#### *Coccidioidomycosis*

11 of 16 patients were successfully treated (at the end of treatment complete or partial resolution of signs and symptoms present at baseline) with posaconazole oral suspension 800 mg/day in divided doses for a median of 296 days and up to 460 days.

#### *Prophylaxis of Invasive Fungal Infections (IFIs) (Studies 316 and 1899)*

Two randomised, controlled prophylaxis studies were conducted among patients at high-risk for developing invasive fungal infections.

Study 316 was a randomised, double-blind study of posaconazole oral suspension (200 mg three times a day) versus fluconazole capsules (400 mg once daily) in allogeneic hematopoietic stem cell transplant recipients with graft-versus-host disease (GVHD). The primary efficacy endpoint was the incidence of proven/probable IFIs at 16 weeks post-randomisation as determined by an independent, blinded external expert panel. A key secondary endpoint was the incidence of proven/probable IFIs during the on-treatment period (first dose to last dose of study medicinal product + 7 days). The majority (377/600, [63 %]) of patients included had Acute Grade 2 or 3 or chronic extensive (195/600, [32.5 %]) GVHD at study start. The mean duration of therapy was 80 days for posaconazole and 77 days for fluconazole.

Study 1899 was a randomised, evaluator-blinded study of posaconazole oral suspension (200 mg three times a day) versus fluconazole suspension (400 mg once daily) or itraconazole oral solution (200 mg twice a day) in neutropenic patients who were receiving cytotoxic chemotherapy for acute myelogenous leukaemia or myelodysplastic syndromes. The primary efficacy endpoint was the incidence of proven/probable IFIs as determined by an independent, blinded external expert panel during the on-treatment period. A key secondary endpoint was the incidence of proven/probable IFIs at 100 days post-randomisation. New diagnosis of acute myelogenous leukaemia was the most common underlying condition (435/602, [72 %]). The mean duration of therapy was 29 days for posaconazole and 25 days for fluconazole/itraconazole.

<sup>2</sup> Includes other less common species or species unknown

In both prophylaxis studies, aspergillosis was the most common breakthrough infection. See Table 7 and 8 for results from both studies. There were fewer breakthrough *Aspergillus* infections in patients receiving posaconazole prophylaxis when compared to control patients.

**Table 7.** Results from clinical studies in prophylaxis of Invasive Fungal Infections

Study	Posaconazole oral suspension	Control <sup>a</sup>	P-Value
<b>Proportion (%) of patients with proven/probable IFIs</b>			
<b>On-treatment period<sup>b</sup></b>			
1899 <sup>d</sup>	7/304 (2)	25/298 (8)	0.0009
316 <sup>e</sup>	7/291 (2)	22/288 (8)	0.0038
<b>Fixed-time period<sup>c</sup></b>			
1899 <sup>d</sup>	14/304 (5)	33/298 (11)	0.0031
316 <sup>d</sup>	16/301 (5)	27/299 (9)	0.0740

FLU = fluconazole ; ITZ = itraconazole ; POS = posaconazole.

A: FLU/ITZ (1899); FLU (316).

B: In 1899 this was the period from randomisation to last dose of study medicinal product plus 7 days; in 316 it was the period from first dose to last dose of study medicinal product plus 7 days.

C: In 1899, this was the period from randomisation to 100 days post-randomisation; in 316 it was the period from the baseline day to 111 days post-baseline.

D: All randomised

e: All treated

**Table 8.** Results from clinical studies in prophylaxis of Invasive Fungal Infections

Study	Posaconazole oral suspension	Control <sup>a</sup>
<b>Proportion (%) of patients with proven/probable Aspergillosis</b>		
<b>On-treatment period<sup>b</sup></b>		
1899 <sup>d</sup>	2/304 (1)	20/298 (7)
316 <sup>e</sup>	3/291 (1)	17/288 (6)
<b>Fixed-time period<sup>c</sup></b>		
1899 <sup>d</sup>	4/304 (1)	26/298 (9)
316 <sup>d</sup>	7/301 (2)	21/299 (7)

FLU = fluconazole ; ITZ = itraconazole ; POS = posaconazole.

A: FLU/ITZ (1899); FLU (316).

B: In 1899 this was the period from randomisation to last dose of study medicinal product plus 7 days; in 316 it was the period from first dose to last dose of study medicinal product plus 7 days.

C: In 1899, this was the period from randomisation to 100 days post-randomisation; in 316 it was the period from the baseline day to 111 days post-baseline.

D: All randomised

e: All treated

In Study 1899, a significant decrease in all cause mortality in favour of posaconazole was observed [POS 49/304 (16 %) vs. FLU/ITZ 67/298 (22 %) p= 0.048]. Based on Kaplan-Meier estimates, the probability of survival up to day 100 after randomisation, was significantly higher for posaconazole recipients; this survival benefit was demonstrated when the analysis considered all causes of death (P= 0.0354) as well as IFI-related deaths (P = 0.0209).

In Study 316, overall mortality was similar (POS, 25 %; FLU, 28 %); however, the proportion of IFI-related deaths was significantly lower in the POS group (4/301) compared with the FLU group (12/299; P= 0.0413).

### Paediatric population

There is limited paediatric experience for posaconazole tablets.

Three patients 14-17 years of age were treated with posaconazole concentrate for solution for infusion and tablet 300 mg/day (BID on Day 1 followed by QD thereafter) in the study of treatment of invasive aspergillosis.

The safety and efficacy of posaconazole (Noxafil gastro-resistant powder and solvent for oral suspension; Noxafil concentrate for solution for infusion) have been established in paediatric patients 2 to less than 18 years of age. Use of posaconazole in these age groups is supported by evidence from adequate and well-controlled studies of posaconazole in adults and pharmacokinetic and safety data from paediatric studies (see section 5.2). No new safety signals associated with the use of posaconazole in paediatric patients were identified in the paediatric studies (see section 4.8).

Safety and efficacy in paediatric patients below the age of 2 years have not been established.

No data are available.

### Electrocardiogram evaluation

Multiple, time-matched ECGs collected over a 12 hour period were obtained before and during administration of posaconazole oral suspension (400 mg twice daily with high fat meals) from 173 healthy male and female volunteers aged 18 to 85 years. No clinically relevant changes in the mean QTc (Fridericia) interval from baseline were observed.

## **5.2 Pharmacokinetic properties**

### Pharmacokinetic / Pharmacodynamic relationships

A correlation between total medicinal product exposure divided by MIC (AUC/MIC) and clinical outcome was observed. The critical ratio for subjects with *Aspergillus* infections was ~200. It is particularly important to try to ensure that maximal plasma levels are achieved in patients infected with *Aspergillus* (see sections 4.2 and 5.2 on recommended dose regimens).

### Absorption

Posaconazole tablets are absorbed with a median  $T_{max}$  of 4 to 5 hours and exhibits dose proportional pharmacokinetics after single and multiple dosing up to 300 mg.

Following a single dose administration of 300 mg posaconazole tablets after a high fat meal to healthy volunteers, the  $AUC_{0-72 \text{ hours}}$  and  $C_{max}$  were higher compared to administration under fasted condition (51 % and 16 % for  $AUC_{0-72 \text{ hours}}$  and  $C_{max}$  respectively). Based on a population pharmacokinetic model, posaconazole  $C_{av}$  is increased 20 % when given with a meal compared to a fasted state.

Posaconazole plasma concentrations following administration of posaconazole tablets may increase over time in some patients. The reason for this time-dependency is not completely understood.

### Distribution

Posaconazole, after administration of the tablet, has a mean apparent volume of distribution of 394 L (42 %), ranging between 294-583 L among the studies in healthy volunteers.

Posaconazole is highly protein bound (> 98 %), predominantly to serum albumin.

### Biotransformation

Posaconazole does not have any major circulating metabolites and its concentrations are unlikely to be altered by inhibitors of CYP450 enzymes. Of the circulating metabolites, the majority are glucuronide conjugates of posaconazole with only minor amounts of oxidative (CYP450 mediated) metabolites observed. The excreted metabolites in urine and faeces account for approximately 17 % of the administered radiolabelled dose.

### Elimination

Posaconazole after administration of the tablets, is slowly eliminated with a mean half-life ( $t_{1/2}$ ) of 29 hours (range 26 to 31 hours) and a mean apparent clearance ranging from 7.5 to 11 L/hr. After administration of  $^{14}\text{C}$ -posaconazole, radioactivity was predominantly recovered in the faeces (77 % of the radiolabelled dose) with the major component being parent compound (66 % of the radiolabelled dose). Renal clearance is a minor elimination pathway, with 14 % of the radiolabelled dose excreted in urine (< 0.2 % of the radiolabelled dose is parent compound). Steady-state plasma concentrations are attained by Day 6 at the 300 mg dose (once daily after twice daily loading dose at Day 1).

### Pharmacokinetics in special populations

Based on a population pharmacokinetic model evaluating posaconazole pharmacokinetics, steady state posaconazole concentrations were predicted in patients administered posaconazole concentrate for solution for infusion or tablets 300 mg once a day following BID dosing on Day 1 for the treatment of invasive aspergillosis and prophylaxis of invasive fungal infections.

**Table 9.** Population predicted median (10<sup>th</sup> percentile, 90<sup>th</sup> percentile) posaconazole steady state plasma concentrations in patients following administration of posaconazole concentrate for solution for infusion or tablets 300 mg QD (BID on Day 1)

<b>Regimen</b>	<b>Population</b>	<b>C<sub>av</sub> (ng/mL)</b>	<b>C<sub>min</sub> (ng/mL)</b>
Tablet-(Fasted)	Prophylaxis	1,550 (874; 2,690)	1,330 (667; 2,400)
	Treatment of Invasive Aspergillosis	1,780 (879; 3,540)	1,490 (663; 3,230)
Concentrate for Solution for Infusion	Prophylaxis	1,890 (1,100; 3,150)	1,500 (745; 2,660)
	Treatment of Invasive Aspergillosis	2,240 (1,230; 4,160)	1,780 (874; 3,620)

The population pharmacokinetic analysis of posaconazole in patients suggests that race, sex, renal impairment and disease (prophylaxis or treatment) have no clinically meaningful effect on the pharmacokinetics of posaconazole.

#### *Children (< 18 years)*

There is limited (n=3) paediatric experience with posaconazole tablets.

The pharmacokinetics of posaconazole oral suspension have been evaluated in paediatric patients. Following administration of 800 mg per day of posaconazole oral suspension as a divided dose for treatment of invasive fungal infections, mean trough plasma concentrations from 12 patients 8 – 17 years of age (776 ng/mL) were similar to concentrations from 194 patients 18 – 64 years of age (817 ng/mL). No pharmacokinetic data are available from paediatric patients less than 8 years of age. Similarly, in the prophylaxis studies, the mean steady-state posaconazole average concentration ( $C_{av}$ ) was comparable among ten adolescents (13-17 years of age) to  $C_{av}$  achieved in adults ( $\geq 18$  years of age).

#### *Gender*

The pharmacokinetics of posaconazole tablets are comparable in men and women.

#### *Elderly*

No overall differences in safety were observed between the geriatric patients and younger patients.

The population pharmacokinetic model of posaconazole concentrate for solution for infusion and tablets indicates that posaconazole clearance is related to age. Posaconazole  $C_{av}$  is generally comparable between young and elderly patients ( $\geq 65$  years of age); however, the  $C_{av}$  is increased by 11 % in the very elderly ( $\geq 80$  years). It is, therefore, suggested to closely monitor very elderly patients ( $\geq 80$  years) for adverse events.

The pharmacokinetics of posaconazole tablets are comparable in young and elderly subjects ( $\geq 65$  years of age).

Pharmacokinetic differences based upon age are not considered to be clinically relevant; therefore, no dose adjustment is required.

#### *Race*

There is insufficient data among different races with posaconazole tablets.

There was a slight decrease (16 %) in the AUC and  $C_{\max}$  of posaconazole oral suspension in Black subjects relative to Caucasian subjects. However, the safety profile of posaconazole between the Black and Caucasian subjects was similar.

#### *Weight*

The population pharmacokinetic model of posaconazole concentrate for solution for infusion and tablets indicates that posaconazole clearance is related to weight. In patients  $> 120$  kg, the  $C_{av}$  is decreased by 25 % and in patients  $< 50$  kg, the  $C_{av}$  is increased by 19 %.

It is, therefore, suggested to closely monitor for breakthrough fungal infections in patients weighing more than 120 kg.

#### *Renal impairment*

Following single-dose administration of posaconazole oral suspension, there was no effect of mild and moderate renal impairment ( $n=18$ ,  $Cl_{cr} \geq 20$  mL/min/1.73 m<sup>2</sup>) on posaconazole pharmacokinetics; therefore, no dose adjustment is required. In subjects with severe renal impairment ( $n=6$ ,  $Cl_{cr} < 20$  mL/min/1.73 m<sup>2</sup>), the AUC of posaconazole was highly variable [ $> 96$  % CV (coefficient of variance)] compared to other renal groups [ $< 40$  % CV]. However, as posaconazole is not significantly renally eliminated, an effect of severe renal impairment on the pharmacokinetics of posaconazole is not expected and no dose adjustment is recommended. Posaconazole is not removed by haemodialysis.

Similar recommendations apply to posaconazole tablets; however, a specific study has not been conducted with the posaconazole tablets.

#### *Hepatic impairment*

After a single oral dose of 400 mg posaconazole oral suspension to patients with mild (Child-Pugh Class A), moderate (Child-Pugh Class B) or severe (Child-Pugh Class C) hepatic impairment (six per group), the mean AUC was 1.3 to 1.6-fold higher compared to that for matched control subjects with normal hepatic function. Unbound concentrations were not determined and it cannot be excluded that there is a larger increase in unbound posaconazole exposure than the observed 60 % increase in total AUC. The elimination half-life ( $t_{1/2}$ ) was prolonged from approximately 27 hours up to  $\sim 43$  hours in respective groups. No dose adjustment is recommended for patients with mild to severe hepatic impairment but caution is advised due to the potential for higher plasma exposure.

Similar recommendations apply to posaconazole tablets; however, a specific study has not been conducted with the posaconazole tablets.

### **5.3 Preclinical safety data**

As observed with other azole antifungal agents, effects related to inhibition of steroid hormone synthesis were seen in repeated-dose toxicity studies with posaconazole. Adrenal suppressive effects were observed in toxicity studies in rats and dogs at exposures equal to or greater than those obtained at therapeutic doses in humans.

Neuronal phospholipidosis occurred in dogs dosed for  $\geq 3$  months at lower systemic exposures than those obtained at therapeutic doses in humans. This finding was not seen in monkeys dosed for one year. In twelve-month neurotoxicity studies in dogs and monkeys, no functional effects were observed on the central or peripheral nervous systems at systemic exposures greater than those achieved therapeutically.

Pulmonary phospholipidosis resulting in dilatation and obstruction of the alveoli was observed in the 2-year study in rats. These findings are not necessarily indicative of a potential for functional changes in humans.

No effects on electrocardiograms, including QT and QTc intervals, were seen in a repeat dose safety pharmacology study in monkeys at maximal plasma concentrations 8.5-fold greater than the concentrations obtained at therapeutic doses in humans. Echocardiography revealed no indication of cardiac decompensation in a repeat dose safety pharmacology study in rats at a systemic exposure 2.1-fold greater than that achieved therapeutically. Increased systolic and arterial blood pressures (up to 29 mm-Hg) were seen in rats and monkeys at systemic exposures 2.1-fold and 8.5-fold greater, respectively, than those achieved with the human therapeutic doses.

Reproduction, peri- and postnatal development studies were conducted in rats. At exposures lower than those obtained at therapeutic doses in humans, posaconazole caused skeletal variations and malformations, dystocia, increased length of gestation, reduced mean litter size and postnatal viability. In rabbits, posaconazole was embryotoxic at exposures greater than those obtained at therapeutic doses. As observed with other azole antifungal agents, these effects on reproduction were considered to be due to a treatment-related effect on steroidogenesis.

Posaconazole was not genotoxic in *in vitro* and *in vivo* studies. Carcinogenicity studies did not reveal special hazards for humans.

In a nonclinical study using intravenous administration of posaconazole in very young dogs (dosed from 2-8 weeks of age) an increase in the incidence of brain ventricle enlargement was observed in treated animals as compared with concurrent control animals. No difference in the incidence of brain ventricle enlargement between control and treated animals was observed following the subsequent 5 month treatment-free period. There were no neurologic, behavioural or developmental abnormalities in the dogs with this finding, and a similar brain finding was not seen with either oral posaconazole administration to juvenile dogs (4 days to 9 months of age) or intravenous posaconazole administration to juvenile dogs (10 weeks to 23 weeks of age). The clinical significance of this finding is unknown.

## **6. PHARMACEUTICAL PARTICULARS**

### **6.1 List of excipients**

#### Tablet core

Hypromellose acetate succinate  
Cellulose, microcrystalline  
Hydroxypropylcellulose (E463)  
Silica dental type  
Croscarmellose sodium  
Magnesium stearate

#### Tablet coat

polyvinyl alcohol  
macrogol 3350  
titanium dioxide (E171)  
talc  
iron oxide yellow (E172)

### **6.2 Incompatibilities**

Not applicable.



### **6.3 Shelf life**

2 years

### **6.4 Special precautions for storage**

This medicinal product does not require any special storage conditions.

### **6.5 Nature and contents of container**

Noxafil 100 mg gastro-resistant tablets are packaged in a PVC/ polychlorotrifluoroethylene laminate blister with push-through aluminium lidding.

Noxafil gastro-resistant tablets are packaged in a blister in cartons of 24 (2x12) or 96 (8x12) tablets.

Not all pack sizes may be marketed.

### **6.6 Special precautions for disposal**

Any unused medicinal product or waste material should be disposed of in accordance with local requirements.

## **7. MARKETING AUTHORISATION HOLDER**

Merck Sharp & Dohme B.V.  
Waarderweg 39  
2031 BN Haarlem  
The Netherlands

## **8. MARKETING AUTHORISATION NUMBER(S)**

EU/1/05/320/002	24 tablets
EU/1/05/320/003	96 tablets

## **9. DATE OF FIRST AUTHORISATION/RENEWAL OF THE AUTHORISATION**

Date of first authorisation: 25 October 2005  
Date of latest renewal: 25 October 2010

## **10. DATE OF REVISION OF THE TEXT**

<{MM/YYYY}>

Detailed information on this medicinal product is available on the website of the European Medicines Agency <http://www.ema.europa.eu>.

## 1. NAME OF THE MEDICINAL PRODUCT

Noxafil 300 mg concentrate for solution for infusion

## 2. QUALITATIVE AND QUANTITATIVE COMPOSITION

Each vial contains 300 mg of posaconazole.

Each mL contains 18 mg of posaconazole.

### Excipients with known effect

Each vial contains 462 mg (20 mmol) of sodium.

Each vial contains 6,680 mg of cyclodextrin (as Betadex Sulfobutyl Ether Sodium (SBECD)).

For the full list of excipients, see section 6.1.

## 3. PHARMACEUTICAL FORM

Concentrate for solution for infusion (sterile concentrate).

Clear, colourless to yellow liquid.

## 4. CLINICAL PARTICULARS

### 4.1 Therapeutic indications

Noxafil concentrate for solution for infusion is indicated for use in the treatment of the following fungal infections in adults (see sections 4.2 and 5.1):

- Invasive aspergillosis

Noxafil concentrate for solution for infusion is indicated for use in the treatment of the following fungal infections in adult and paediatric patients from 2 years of age (see sections 4.2 and 5.1):

- Invasive aspergillosis in patients with disease that is refractory to amphotericin B or itraconazole or in patients who are intolerant of these medicinal products;
- Fusariosis in patients with disease that is refractory to amphotericin B or in patients who are intolerant of amphotericin B;
- Chromoblastomycosis and mycetoma in patients with disease that is refractory to itraconazole or in patients who are intolerant of itraconazole;
- Coccidioidomycosis in patients with disease that is refractory to amphotericin B, itraconazole or fluconazole or in patients who are intolerant of these medicinal products.

Refractoriness is defined as progression of infection or failure to improve after a minimum of 7 days of prior therapeutic doses of effective antifungal therapy.

Noxafil concentrate for solution for infusion is also indicated for prophylaxis of invasive fungal infections in the following adult and paediatric patients from 2 years of age (see sections 4.2 and 5.1):

- Patients receiving remission-induction chemotherapy for acute myelogenous leukaemia (AML) or myelodysplastic syndromes (MDS) expected to result in prolonged neutropenia and who are at high-risk of developing invasive fungal infections;
- Hematopoietic stem cell transplant (HSCT) recipients who are undergoing high-dose immunosuppressive therapy for graft versus host disease (GVHD) and who are at high-risk of developing invasive fungal infections.

Please refer to the Summary of Product Characteristics of Noxafil oral suspension for use in oropharyngeal candidiasis.

## 4.2 Posology and method of administration

Treatment should be initiated by a physician experienced in the management of fungal infections or in the supportive care of high-risk patients for which posaconazole is indicated as prophylaxis.

### Posology

Noxafil is also available for oral administration (Noxafil 100 mg gastro-resistant tablets, 40 mg/mL oral suspension, and 300 mg gastro-resistant powder and solvent for oral suspension). A switch to oral administration is recommended as soon as the patients' condition allows (see section 4.4).

Recommended dose is shown in Table 1.

**Table 1.** Recommended dose according to indication

<b>Indication</b>	<b>Dose and duration of therapy</b> (See section 5.2)
Treatment of invasive aspergillosis (only for adults)	<p>Loading dose of 300 mg Noxafil (300 mg concentrate for solution for infusion or three 100 mg tablets) twice a day on the first day, then 300 mg (300 mg concentrate for solution for infusion or three 100 mg tablets) once a day thereafter.</p> <p>Each tablet dose may be taken without regard to food intake.</p> <p>Recommended total duration of therapy is 6-12 weeks.</p> <p>Switching between intravenous and oral administration is appropriate when clinically indicated.</p>
Refractory invasive fungal infections (IFI)/patients with IFI intolerant to 1 <sup>st</sup> line therapy	<p><b>Adults:</b></p> <p>Loading dose of 300 mg Noxafil twice a day on the first day, then 300 mg once a day thereafter. Duration of therapy should be based on the severity of the underlying disease, recovery from immunosuppression, and clinical response.</p>
	<p><b>Paediatric patients aged 2 to less than 18 years:</b></p> <p>Loading dose of 6 mg/kg (to a maximum of 300 mg) twice a day on the first day, then 6 mg/kg (to a maximum of 300 mg) once a day thereafter. Duration of therapy should be based on the severity of the underlying disease, recovery from immunosuppression, and clinical response.</p>
Prophylaxis of invasive fungal infections	<p><b>Adults:</b></p> <p>Loading dose of 300 mg Noxafil twice a day on the first day, then 300 mg once a day thereafter. Duration of therapy is based on recovery from neutropenia or immunosuppression. For patients with AML or MDS, prophylaxis with Noxafil should start several days before the anticipated onset of neutropenia and continue for 7 days after the neutrophil count rises above 500 cells per mm<sup>3</sup>.</p>
	<p><b>Paediatric patients aged 2 to less than 18 years:</b></p> <p>Loading dose of 6 mg/kg (to a maximum of 300 mg) twice a day on the first day, then 6 mg/kg (to a maximum of 300 mg) once a day thereafter. Duration of therapy is based on recovery from neutropenia or immunosuppression. For patients with acute myelogenous leukaemia or myelodysplastic syndromes, prophylaxis with Noxafil should start several days before the anticipated onset of neutropenia and continue for 7 days after the neutrophil count rises above 500 cells per mm<sup>3</sup>.</p>

Noxafil should be administered via a central venous line, including a central venous catheter or peripherally inserted central catheter (PICC) by slow intravenous infusion over approximately 90 minutes. Noxafil concentrate for solution for infusion should not be given by bolus administration. If a central venous catheter is not available, a single infusion may be administered through a peripheral venous catheter. When administered through a peripheral venous catheter, the infusion should be administered over approximately 30 minutes (see sections 4.8 and 6.6).

### Special populations

#### *Renal impairment*

In patients with moderate or severe renal impairment (creatinine clearance <50 mL/min), accumulation of the intravenous vehicle, Betadex Sulfobutyl Ether Sodium (SBECD), is expected to occur. Oral formulations of Noxafil should be used in these patients unless an assessment of the benefit/risk to the patient justifies the use of Noxafil concentrate for solution for infusion. Serum creatinine levels should be closely monitored in these patients (see section 4.4).

#### *Hepatic impairment*

Limited data on the effect of hepatic impairment (including Child-Pugh C classification of chronic liver disease) on the pharmacokinetics of posaconazole demonstrate an increase in plasma exposure compared to subjects with normal hepatic function, but do not suggest that dose adjustment is necessary (see sections 4.4 and 5.2). It is recommended to exercise caution due to the potential for higher plasma exposure.

#### *Paediatric population*

The safety and efficacy of posaconazole in children aged below 2 years have not been established. No clinical data are available.

Noxafil concentrate for solution for infusion should not be used in children aged below 2 years because of pre-clinical safety concerns (see section 5.3).

### Method of administration

Noxafil concentrate for solution for infusion requires dilution (see section 6.6) prior to administration. Noxafil should be administered via a central venous line, including a central venous catheter or peripherally inserted central catheter (PICC) by slow intravenous (IV) infusion over approximately 90 minutes (see sections 4.2, 4.4, and 4.8).

Noxafil concentrate for solution for infusion should not be given by bolus administration.

If a central venous catheter is not available, a single infusion may be administered through a peripheral venous catheter. When administered through a peripheral venous catheter, the infusion should be administered over approximately 30 minutes to reduce the likelihood of infusion site reactions (see section 4.8).

## **4.3 Contraindications**

Hypersensitivity to the active substance or to any of the excipients listed in section 6.1.

Co-administration with ergot alkaloids (see section 4.5).

Co-administration with the CYP3A4 substrates terfenadine, astemizole, cisapride, pimozone, halofantrine or quinidine since this may result in increased plasma concentrations of these medicinal products, leading to QTc prolongation and rare occurrences of torsades de pointes (see sections 4.4 and 4.5).

Co-administration with the HMG-CoA reductase inhibitors simvastatin, lovastatin and atorvastatin (see section 4.5).

Co-administration during the initiation and dose-titration phase of venetoclax in Chronic Lymphocytic Leukaemia (CLL) patients (see sections 4.4 and 4.5).

## 4.4 Special warnings and precautions for use

### Hypersensitivity

There is no information regarding cross-sensitivity between posaconazole and other azole antifungal agents. Caution should be used when prescribing posaconazole to patients with hypersensitivity to other azoles.

### Hepatic toxicity

Hepatic reactions (e.g. elevations in ALT, AST, alkaline phosphatase, total bilirubin and/or clinical hepatitis) have been reported during treatment with posaconazole. Elevated liver function tests were generally reversible on discontinuation of therapy and in some instances these tests normalised without interruption of therapy. Rarely, more severe hepatic reactions with fatal outcomes have been reported.

Posaconazole should be used with caution in patients with hepatic impairment due to limited clinical experience and the possibility that posaconazole plasma levels may be higher in these patients (see sections 4.2 and 5.2).

### Monitoring of patients with severe renal impairment

Due to the variability in exposure, patients with severe renal impairment should be monitored closely for breakthrough fungal infections (see sections 4.2 and 5.2).

### Monitoring of hepatic function

Liver function tests should be evaluated at the start of and during the course of posaconazole therapy. Patients who develop abnormal liver function tests during posaconazole therapy must be routinely monitored for the development of more severe hepatic injury. Patient management should include laboratory evaluation of hepatic function (particularly liver function tests and bilirubin). Discontinuation of posaconazole should be considered if clinical signs and symptoms are consistent with development of liver disease.

### QTc prolongation

Some azoles have been associated with prolongation of the QTc interval. Posaconazole must not be administered with medicinal products that are substrates for CYP3A4 and are known to prolong the QTc interval (see sections 4.3 and 4.5). Posaconazole should be administered with caution to patients with pro-arrhythmic conditions such as:

- Congenital or acquired QTc prolongation
- Cardiomyopathy, especially in the presence of cardiac failure
- Sinus bradycardia
- Existing symptomatic arrhythmias
- Concomitant use with medicinal products known to prolong the QTc interval (other than those mentioned in section 4.3).

Electrolyte disturbances, especially those involving potassium, magnesium or calcium levels, should be monitored and corrected as necessary before and during posaconazole therapy.

In patients, mean maximum plasma concentrations ( $C_{max}$ ) after posaconazole concentrate for solution for infusion are 4-fold increased compared to administration of oral suspension. An increased effect on the QTc interval cannot be ruled out. Particular caution is advised in such cases where posaconazole is administered peripherally, as the recommended infusion time of 30 minutes may further increase  $C_{max}$ .

### Drug interactions

Posaconazole is an inhibitor of CYP3A4 and should only be used under specific circumstances during treatment with other medicinal products that are metabolised by CYP3A4 (see section 4.5).

### Midazolam and other benzodiazepines

Due to the risk of prolonged sedation and possible respiratory depression co-administration of posaconazole with any benzodiazepines metabolised by CYP3A4 (e.g. midazolam, triazolam,

alprazolam) should only be considered if clearly necessary. Dose adjustment of benzodiazepines metabolised by CYP3A4 should be considered (see section 4.5).

#### Vincristine toxicity

Concomitant administration of azole antifungals, including posaconazole, with vincristine has been associated with neurotoxicity and other serious adverse reactions, including seizures, peripheral neuropathy, syndrome of inappropriate antidiuretic hormone secretion, and paralytic ileus. Reserve azole antifungals, including posaconazole, for patients receiving a vinca alkaloid, including vincristine, who have no alternative antifungal treatment options (see section 4.5).

#### Venetoclax toxicity

Concomitant administration of strong CYP3A inhibitors, including posaconazole, with the CYP3A4 substrate venetoclax, may increase venetoclax toxicities, including the risk of tumour lysis syndrome (TLS) and neutropenia (see sections 4.3 and 4.5). Refer to the venetoclax SmPC for detailed guidance.

#### Rifamycin antibacterials (rifampicin, rifabutin), certain anticonvulsants (phenytoin, carbamazepine, phenobarbital, primidone), and efavirenz

Posaconazole concentrations may be significantly lowered in combination; therefore, concomitant use with posaconazole should be avoided unless the benefit to the patient outweighs the risk (see section 4.5).

#### Plasma exposure

Plasma concentrations following administration of posaconazole intravenous concentrate for solution for infusion are generally higher than those obtained with posaconazole oral suspension. Posaconazole plasma concentrations following administration of posaconazole may increase over time in some patients (see section 5.2).

#### Thromboembolic events

Thromboembolic events have been identified as a potential risk for posaconazole intravenous concentrate for solution for infusion but were not observed in the clinical studies. Thrombophlebitis was observed in clinical studies. Caution is warranted on any sign or symptom of thromboembolic events (see sections 4.8 and 5.3).

#### Sodium

This medicinal product contains 462 mg (20 mmol) sodium per vial, equivalent to 23 % of the WHO recommended maximum daily intake of sodium.

The maximum daily dose of this product is equivalent to 46% of the WHO recommended maximum daily intake for sodium.

Noxafil 300 mg concentrate for solution for infusion is considered high in sodium. This should be particularly taken into account for those on a low salt diet.

#### Cyclodextrin

This medicinal product contains 6,680 mg of cyclodextrin per vial.

### **4.5 Interaction with other medicinal products and other forms of interaction**

The following information was derived from data with posaconazole oral suspension or early tablet formulation. All drug interactions with posaconazole oral suspension, except for those that affect the absorption of posaconazole (via gastric pH and motility) are considered relevant to posaconazole concentrate for solution for infusion as well.

#### Effects of other medicinal products on posaconazole

Posaconazole is metabolised via UDP glucuronidation (phase 2 enzymes) and is a substrate for p-glycoprotein (P-gp) efflux *in vitro*. Therefore, inhibitors (e.g. verapamil, ciclosporin, quinidine, clarithromycin, erythromycin, etc.) or inducers (e.g. rifampicin, rifabutin, certain anticonvulsants, etc.) of these clearance pathways may increase or decrease posaconazole plasma concentrations, respectively.

### *Rifabutin*

Rifabutin (300 mg once a day) decreased the  $C_{max}$  (maximum plasma concentration) and AUC (area under the plasma concentration time curve) of posaconazole to 57 % and 51 %, respectively. Concomitant use of posaconazole and rifabutin and similar inducers (e.g. rifampicin) should be avoided unless the benefit to the patient outweighs the risk. See also below regarding the effect of posaconazole on rifabutin plasma levels.

### *Efavirenz*

Efavirenz (400 mg once a day) decreased the  $C_{max}$  and AUC of posaconazole by 45 % and 50 %, respectively. Concomitant use of posaconazole and efavirenz should be avoided unless the benefit to the patient outweighs the risk.

### *Fosamprenavir*

Combining fosamprenavir with posaconazole may lead to decreased posaconazole plasma concentrations. If concomitant administration is required, close monitoring for breakthrough fungal infections is recommended. Repeat dose administration of fosamprenavir (700 mg twice daily x 10 days) decreased the  $C_{max}$  and AUC of posaconazole oral suspension (200 mg once daily on the 1<sup>st</sup> day, 200 mg twice daily on the 2<sup>nd</sup> day, then 400 mg twice daily x 8 Days) by 21 % and 23 %, respectively. The effect of posaconazole on fosamprenavir levels when fosamprenavir is given with ritonavir is unknown.

### *Phenytoin*

Phenytoin (200 mg once a day) decreased the  $C_{max}$  and AUC of posaconazole by 41 % and 50 %, respectively. Concomitant use of posaconazole and phenytoin and similar inducers (e.g. carbamazepine, phenobarbital, primidone) should be avoided unless the benefit to the patient outweighs the risk.

### Effects of posaconazole on other medicinal products

Posaconazole is a potent inhibitor of CYP3A4. Co-administration of posaconazole with CYP3A4 substrates may result in large increases in exposure to CYP3A4 substrates as exemplified by the effects on tacrolimus, sirolimus, atazanavir and midazolam below. Caution is advised during co-administration of posaconazole with CYP3A4 substrates administered intravenously and the dose of the CYP3A4 substrate may need to be reduced. If posaconazole is used concomitantly with CYP3A4 substrates that are administered orally, and for which an increase in plasma concentrations may be associated with unacceptable adverse reactions, plasma concentrations of the CYP3A4 substrate and/or adverse reactions should be closely monitored and the dose adjusted as needed.

### *Terfenadine, astemizole, cisapride, pimozide, halofantrine and quinidine (CYP3A4 substrates)*

Co-administration of posaconazole and terfenadine, astemizole, cisapride, pimozide, halofantrine or quinidine is contraindicated. Co-administration may result in increased plasma concentrations of these medicinal products, leading to QTc prolongation and rare occurrences of torsades de pointes (see section 4.3).

### *Ergot alkaloids*

Posaconazole may increase the plasma concentration of ergot alkaloids (ergotamine and dihydroergotamine), which may lead to ergotism. Co-administration of posaconazole and ergot alkaloids is contraindicated (see section 4.3).

### *HMG-CoA reductase inhibitors metabolised through CYP3A4 (e.g. simvastatin, lovastatin, and atorvastatin)*

Posaconazole may substantially increase plasma levels of HMG-CoA reductase inhibitors that are metabolised by CYP3A4. Treatment with these HMG-CoA reductase inhibitors should be discontinued during treatment with posaconazole as increased levels have been associated with rhabdomyolysis (see section 4.3).

### *Vinca alkaloids*

Most of the vinca alkaloids (e.g. vincristine and vinblastine) are substrates of CYP3A4. Concomitant administration of azole antifungals, including posaconazole, with vincristine has been associated with serious adverse reactions (see section 4.4). Posaconazole may increase the plasma concentrations of vinca alkaloids which may lead to neurotoxicity and other serious adverse reactions. Therefore, reserve azole antifungals, including posaconazole, for patients receiving a vinca alkaloid, including vincristine, who have no alternative antifungal treatment options.

### *Rifabutin*

After oral administration, posaconazole increased the  $C_{max}$  and AUC of rifabutin by 31 % and 72 %, respectively. Concomitant use of posaconazole and rifabutin should be avoided unless the benefit to the patient outweighs the risk (see also above regarding the effect of rifabutin on plasma levels of posaconazole). If these medicinal products are co-administered, careful monitoring of full blood counts and adverse reactions related to increased rifabutin levels (e.g. uveitis) is recommended.

### *Sirolimus*

Repeat dose administration of oral posaconazole oral suspension (400 mg twice daily for 16 days) increased the  $C_{max}$  and AUC of sirolimus (2 mg single dose) an average of 6.7-fold and 8.9-fold (range 3.1 to 17.5-fold), respectively, in healthy subjects. The effect of posaconazole on sirolimus in patients is unknown, but is expected to be variable due to the variable posaconazole exposure in patients. Co-administration of posaconazole with sirolimus is not recommended and should be avoided whenever possible. If it is considered that co-administration is unavoidable, then it is recommended that the dose of sirolimus should be greatly reduced at the time of initiation of posaconazole therapy and that there should be very frequent monitoring of trough concentrations of sirolimus in whole blood. Sirolimus concentrations should be measured upon initiation, during co-administration, and at discontinuation of posaconazole treatment, with sirolimus doses adjusted accordingly. It should be noted that the relationship between sirolimus trough concentration and AUC is changed during co-administration with posaconazole. As a result, sirolimus trough concentrations that fall within the usual therapeutic range may result in sub-therapeutic levels. Therefore trough concentrations that fall in the upper part of the usual therapeutic range should be targeted and careful attention should be paid to clinical signs and symptoms, laboratory parameters and tissue biopsies.

### *Ciclosporin*

In heart transplant patients on stable doses of ciclosporin, posaconazole oral suspension 200 mg once daily increased ciclosporin concentrations requiring dose reductions. Cases of elevated ciclosporin levels resulting in serious adverse reactions, including nephrotoxicity and one fatal case of leukoencephalopathy, were reported in clinical efficacy studies. When initiating treatment with posaconazole in patients already receiving ciclosporin, the dose of ciclosporin should be reduced (e.g. to about three quarters of the current dose). Thereafter blood levels of ciclosporin should be monitored carefully during co-administration, and upon discontinuation of posaconazole treatment, and the dose of ciclosporin should be adjusted as necessary.

### *Tacrolimus*

Posaconazole increased  $C_{max}$  and AUC of tacrolimus (0.05 mg/kg body weight single dose) by 121 % and 358 %, respectively. Clinically significant interactions resulting in hospitalisation and/or posaconazole discontinuation were reported in clinical efficacy studies. When initiating posaconazole treatment in patients already receiving tacrolimus, the dose of tacrolimus should be reduced (e.g. to about one third of the current dose). Thereafter blood levels of tacrolimus should be monitored carefully during co-administration, and upon discontinuation of posaconazole, and the dose of tacrolimus should be adjusted as necessary.

### *HIV Protease inhibitors*

As HIV protease inhibitors are CYP3A4 substrates, it is expected that posaconazole will increase plasma levels of these antiretroviral agents. Following co-administration of posaconazole oral suspension (400 mg twice daily) with atazanavir (300 mg once daily) for 7 days in healthy subjects  $C_{max}$  and AUC of atazanavir increased by an average of 2.6-fold and 3.7-fold (range 1.2 to 26-fold), respectively. Following co-administration of posaconazole oral suspension (400 mg twice daily) with



atazanavir and ritonavir (300/100 mg once daily) for 7 days in healthy subjects  $C_{max}$  and AUC of atazanavir increased by an average of 1.5-fold and 2.5-fold (range 0.9 to 4.1-fold), respectively. The addition of posaconazole to therapy with atazanavir or with atazanavir plus ritonavir was associated with increases in plasma bilirubin levels. Frequent monitoring for adverse reactions and toxicity related to antiretroviral agents that are substrates of CYP3A4 is recommended during co-administration with posaconazole.

#### *Midazolam and other benzodiazepines metabolised by CYP3A4*

In a study in healthy volunteers posaconazole oral suspension (200 mg once daily for 10 days) increased the exposure (AUC) of intravenous midazolam (0.05 mg/kg) by 83 %. In another study in healthy volunteers, repeat dose administration of posaconazole oral suspension (200 mg twice daily for 7 days) increased the  $C_{max}$  and AUC of intravenous midazolam (0.4 mg single dose) by an average of 1.3- and 4.6-fold (range 1.7 to 6.4-fold), respectively; Posaconazole oral suspension 400 mg twice daily for 7 days increased the intravenous midazolam  $C_{max}$  and AUC by 1.6 and 6.2-fold (range 1.6 to 7.6-fold), respectively. Both doses of posaconazole increased  $C_{max}$  and AUC of oral midazolam (2 mg single oral dose) by 2.2 and 4.5-fold, respectively. In addition, posaconazole oral suspension (200 mg or 400 mg) prolonged the mean terminal half-life of midazolam from approximately 3-4 hours to 8-10 hours during co-administration.

Due to the risk of prolonged sedation it is recommended that dose adjustments should be considered when posaconazole is administered concomitantly with any benzodiazepine that is metabolised by CYP3A4 (e.g. midazolam, triazolam, alprazolam) (see section 4.4).

#### *Calcium channel blockers metabolised through CYP3A4 (e.g. diltiazem, verapamil, nifedipine, nisoldipine)*

Frequent monitoring for adverse reactions and toxicity related to calcium channel blockers is recommended during co-administration with posaconazole. Dose adjustment of calcium channel blockers may be required.

#### *Digoxin*

Administration of other azoles has been associated with increases in digoxin levels. Therefore, posaconazole may increase plasma concentration of digoxin and digoxin levels need to be monitored when initiating or discontinuing posaconazole treatment.

#### *Sulfonylureas*

Glucose concentrations decreased in some healthy volunteers when glipizide was co-administered with posaconazole. Monitoring of glucose concentrations is recommended in diabetic patients.

#### *All-trans retinoic acid (ATRA) or tretinoin*

As ATRA is metabolised by the hepatic CYP450 enzymes, notably CYP3A4, concomitant administration with posaconazole, which is a strong inhibitor of CYP3A4, may lead to increased exposure to tretinoin resulting in an increased toxicity (especially hypercalcaemia). Serum calcium levels should be monitored and, if needed, appropriate dose adjustments of tretinoin should be considered during the treatment with posaconazole, and during the following days after treatment.

#### *Venetoclax*

Compared with venetoclax 400 mg administered alone, co-administration of 300 mg posaconazole, a strong CYP3A inhibitor, with venetoclax 50 mg and 100 mg for 7 days in 12 patients, increased venetoclax  $C_{max}$  to 1.6-fold and 1.9-fold, and AUC to 1.9-fold and 2.4-fold, respectively (see sections 4.3 and 4.4).

Refer to the venetoclax SmPC.

#### Paediatric population

Interaction studies have only been performed in adults.

## 4.6 Fertility, pregnancy and lactation

### Pregnancy

There is insufficient information on the use of posaconazole in pregnant women. Studies in animals have shown reproductive toxicity (see section 5.3). The potential risk for humans is unknown.

Women of childbearing potential have to use effective contraception during treatment. Posaconazole must not be used during pregnancy unless the benefit to the mother clearly outweighs the potential risk to the foetus.

### Breast-feeding

Posaconazole is excreted into the milk of lactating rats (see section 5.3). The excretion of posaconazole in human breast milk has not been investigated. Breast-feeding must be stopped on initiation of treatment with posaconazole.

### Fertility

Posaconazole had no effect on fertility of male rats at doses up to 180 mg/kg (2.8 times the exposure achieved from a 300 mg intravenous dose in human) or female rats at a dose up to 45 mg/kg (3.4 times the exposure from a 300 mg intravenous dose in patients). There is no clinical experience assessing the impact of posaconazole on fertility in humans.

## 4.7 Effects on ability to drive and use machines

Since certain adverse reactions (e.g. dizziness, somnolence, etc.) have been reported with posaconazole use, which potentially may affect driving/operating machinery, caution needs to be used.

## 4.8 Undesirable effects

### Summary of the safety profile

Safety data mainly derive from studies with the oral suspension.

The safety of posaconazole oral suspension has been assessed in > 2,400 patients and healthy volunteers enrolled in clinical studies and from post-marketing experience. The most frequently reported serious related adverse reactions included nausea, vomiting, diarrhoea, pyrexia, and increased bilirubin.

### Posaconazole concentrate for solution for infusion

The safety of posaconazole concentrate for solution for infusion has been assessed in 72 healthy volunteers and 268 patients enrolled in a clinical study of antifungal prophylaxis.

The safety of posaconazole concentrate for solution for infusion and posaconazole tablet has been assessed in 288 patients enrolled in a clinical study of aspergillosis of whom 161 patients received the concentrate for solution for infusion and 127 patients received the tablet formulation.

Posaconazole concentrate for solution for infusion was investigated in AML and MDS patients and those after HSCT with or at risk for GVHD only. Maximum duration of exposure to the concentrate for solution for infusion was shorter than with the oral suspension. Plasma exposure resulting from the solution for infusion was higher than observed with the oral suspension.

In initial studies of healthy volunteers, administration of a single dose of posaconazole infused over 30 minutes via a peripheral venous catheter was associated with a 12 % incidence of infusion site reactions (4 % incidence of thrombophlebitis). Multiple doses of posaconazole administered via a peripheral venous catheter were associated with thrombophlebitis (60 % incidence). Therefore, in subsequent studies posaconazole was administered via central venous catheter. If a central venous catheter was not readily available, patients could receive a single infusion over 30 minutes via a peripheral venous catheter. Peripheral infusion time longer than 30 minutes, leads to a higher incidence of infusion site reactions and thrombophlebitis.

The safety of posaconazole concentrate for solution for infusion has been assessed in 268 patients in clinical studies. Patients were enrolled in a non-comparative pharmacokinetic and safety study of posaconazole concentrate for solution for infusion when given as antifungal prophylaxis (Study 5520). Eleven patients received a single dose of 200 mg posaconazole concentrate for solution for infusion, 21 patients received 200 mg daily dose for a median of 14 days, and 237 patients received 300 mg daily dose for a median of 9 days. No safety data are available for administration > 28 days. Safety data in the elderly are limited.

The most frequently reported adverse reaction (>25 %) with an onset during the posaconazole intravenous phase of dosing with 300 mg once daily was diarrhoea (32 %).

The most common adverse reaction (>1 %) leading to discontinuation of posaconazole concentrate for solution for infusion 300 mg once daily was AML (1 %).

The safety of posaconazole tablets and concentrate for solution for infusion were also investigated in a controlled study of treatment of invasive aspergillosis. The maximum duration of invasive aspergillosis treatment was similar to that studied with the oral suspension for salvage treatment and was longer than that with the tablets or concentrate for solution for infusion in prophylaxis.

*Posaconazole gastro-resistant powder and solvent for oral suspension and concentrate for solution for infusion safety*

The safety of posaconazole gastro-resistant powder and solvent for oral suspension and concentrate for solution for infusion has been assessed in 115 paediatric patients aged 2 to less than 18 years for prophylaxis use. Immunocompromised paediatric patients with known or expected neutropenia were exposed to posaconazole at 3.5 mg/kg, 4.5 mg/kg or 6 mg/kg.

Reported adverse reactions were generally consistent with those expected in a paediatric oncology population undergoing treatment for malignancy or with the safety profile of posaconazole in adults.

The most frequently reported adverse reactions (>2 %) during treatment were alanine aminotransferase increased (2.6 %), aspartate aminotransferase increased (3.5 %) and rash (2.6 %).

Tabulated list of adverse reactions

Within the organ system classes, adverse reactions are listed under headings of frequency using the following categories: very common (≥1/10); common (≥1/100 to <1/10); uncommon (≥1/1,000 to <1/100); rare (≥ 1/10,000 to <1/1,000); very rare (<1/10,000); not known (cannot be estimated from the available data).

**Table 2.** Adverse reactions by body system and frequency reported in clinical studies and/or post-marketing use\*

<b>Blood and lymphatic system disorders</b>	
Common:	neutropenia
Uncommon:	thrombocytopenia, leukopenia, anaemia, eosinophilia, lymphadenopathy, splenic infarction
Rare:	haemolytic uraemic syndrome, thrombotic thrombocytopenic purpura, pancytopenia, coagulopathy, haemorrhage
<b>Immune system disorders</b>	
Uncommon:	allergic reaction
Rare:	hypersensitivity reaction

<b>Endocrine disorders</b> Rare:	adrenal insufficiency, blood gonadotropin decreased, pseudoaldosteronism
<b>Metabolism and nutrition disorders</b> Common: Uncommon:	electrolyte imbalance, anorexia, decreased appetite, hypokalaemia, hypomagnesaemia hyperglycaemia, hypoglycaemia
<b>Psychiatric disorders</b> Uncommon: Rare:	abnormal dreams, confusional state, sleep disorder psychotic disorder, depression
<b>Nervous system disorders</b> Common: Uncommon: Rare:	paraesthesia, dizziness, somnolence, headache, dysgeusia convulsions, neuropathy, hypoaesthesia, tremor, aphasia, insomnia cerebrovascular accident, encephalopathy, peripheral neuropathy, syncope
<b>Eye disorders</b> Uncommon: Rare:	blurred vision, photophobia, visual acuity reduced diplopia, scotoma
<b>Ear and labyrinth disorder</b> Rare:	hearing impairment
<b>Cardiac disorders</b> Uncommon: Rare:	long QT syndrome <sup>§</sup> , electrocardiogram abnormal <sup>§</sup> , palpitations, bradycardia, supraventricular extrasystoles, tachycardia torsade de pointes, sudden death, ventricular tachycardia, cardio-respiratory arrest, cardiac failure, myocardial infarction
<b>Vascular disorders</b> Common: Uncommon: Rare:	hypertension hypotension, thrombophlebitis, vasculitis pulmonary embolism, deep vein thrombosis
<b>Respiratory, thoracic and mediastinal disorders</b> Uncommon: Rare:	cough, epistaxis, hiccups, nasal congestion, pleuritic pain, tachypnoea pulmonary hypertension, interstitial pneumonia, pneumonitis
<b>Gastrointestinal disorders</b> Very Common Common: Uncommon: Rare:	nausea vomiting, abdominal pain, diarrhoea, dyspepsia, dry mouth, flatulence, constipation, anorectal discomfort pancreatitis, abdominal distension, enteritis, epigastric discomfort, eructation, gastroesophageal reflux disease, oedema mouth gastrointestinal haemorrhage, ileus
<b>Hepatobiliary disorders</b> Common: Uncommon: Rare:	liver function tests raised (ALT increased, AST increased, bilirubin increased, alkaline phosphatase increased, GGT increased) hepatocellular damage, hepatitis, jaundice, hepatomegaly, cholestasis, hepatic toxicity, hepatic function abnormal hepatic failure, hepatitis cholestatic, hepatosplenomegaly, liver tenderness, asterixis

<b>Skin and subcutaneous tissue disorders</b> Common: Uncommon: Rare:	rash, pruritis mouth ulceration, alopecia, dermatitis, erythema, petechiae Stevens Johnson syndrome, vesicular rash
<b>Musculoskeletal and connective tissue disorders</b> Uncommon:	back pain, neck pain, musculoskeletal pain, pain in extremity
<b>Renal and urinary disorders</b> Uncommon: Rare:	acute renal failure, renal failure, blood creatinine increased renal tubular acidosis, interstitial nephritis
<b>Reproductive system and breast disorders</b> Uncommon: Rare:	menstrual disorder breast pain
<b>General disorders and administration site conditions</b> Common: Uncommon: Rare:	pyrexia (fever), asthenia, fatigue oedema, pain, chills, malaise, chest discomfort, drug intolerance, feeling jittery, infusion site pain, infusion site phlebitis, infusion site thrombosis, mucosal inflammation tongue oedema, face oedema
<b>Investigations</b> Uncommon:	altered medicine levels, blood phosphorus decreased, chest x-ray abnormal

\* Based on adverse reactions observed with the oral suspension, gastro-resistant tablets, concentrate for solution for infusion, and gastro-resistant powder and solvent for oral suspension.

§ See section 4.4.

#### Description of selected adverse reactions

##### *Hepatobiliary disorders*

During post-marketing surveillance severe hepatic injury with fatal outcome has been reported (see section 4.4).

#### Reporting of suspected adverse reactions

Reporting suspected adverse reactions after authorisation of the medicinal product is important. It allows continued monitoring of the benefit/risk balance of the medicinal product. Healthcare professionals are asked to report any suspected adverse reactions via the **national reporting system** listed in [Appendix V](#).

## **4.9 Overdose**

There is no experience with overdose of posaconazole concentrate for solution for infusion.

During clinical studies, patients who received posaconazole oral suspension doses up to 1,600 mg/day experienced no different adverse reactions from those reported with patients at the lower doses.

Accidental overdose was noted in one patient who took posaconazole oral suspension 1,200 mg twice a day for 3 days. No adverse reactions were noted by the investigator.

Posaconazole is not removed by haemodialysis. There is no special treatment available in the case of overdose with posaconazole. Supportive care may be considered.

## 5. PHARMACOLOGICAL PROPERTIES

### 5.1 Pharmacodynamic properties

Pharmacotherapeutic group: Antimycotics for systemic use, triazole derivatives, ATC code: J02A C04.

#### Mechanism of action

Posaconazole inhibits the enzyme lanosterol 14 $\alpha$ -demethylase (CYP51), which catalyses an essential step in ergosterol biosynthesis.

#### Microbiology

Posaconazole has been shown *in vitro* to be active against the following microorganisms: *Aspergillus* species (*Aspergillus fumigatus*, *A. flavus*, *A. terreus*, *A. nidulans*, *A. niger*, *A. ustus*), *Candida* species (*Candida albicans*, *C. glabrata*, *C. krusei*, *C. parapsilosis*, *C. tropicalis*, *C. dubliniensis*, *C. famata*, *C. inconspicua*, *C. lipolytica*, *C. norvegensis*, *C. pseudotropicalis*), *Coccidioides immitis*, *Fonsecaea pedrosoi*, and species of *Fusarium*, *Rhizomucor*, *Mucor*, and *Rhizopus*. The microbiological data suggest that posaconazole is active against *Rhizomucor*, *Mucor*, and *Rhizopus*; however, the clinical data are currently too limited to assess the efficacy of posaconazole against these causative agents.

The following *in vitro* data are available, but their clinical significance is unknown. In a surveillance study of > 3,000 clinical mold isolates from 2010-2018, 90 % of non-*Aspergillus* fungi exhibited the following *in vitro* minimum inhibitory concentration (MIC): *Mucorales* spp (n=81) of 2 mg/L; *Scedosporium apiospermum*/*S. boydii* (n=65) of 2 mg/L; *Exophiala dermatiditis* (n=15) of 0.5 mg/L, and *Purpureocillium lilacinum* (n=21) of 1 mg/L.

#### Resistance

Clinical isolates with decreased susceptibility to posaconazole have been identified. The principle mechanism of resistance is the acquisition of substitutions in the target protein, CYP51.

#### Epidemiological Cut-off (ECOFF) values for *Aspergillus* spp.

The ECOFF values for posaconazole, which distinguish the wild type population from isolates with acquired resistance, have been determined by EUCAST methodology.

EUCAST ECOFF values:

- *Aspergillus flavus*: 0.5 mg/L
- *Aspergillus fumigatus*: 0.5 mg/L
- *Aspergillus nidulans*: 0.5 mg/L
- *Aspergillus niger*: 0.5 mg/L
- *Aspergillus terreus*: 0.25 mg/L

There are currently insufficient data to set clinical breakpoints for *Aspergillus* spp. ECOFF values do not equate to clinical breakpoints.

#### Breakpoints

EUCAST MIC breakpoints for posaconazole [susceptible (S); resistant (R)]:

- *Candida albicans*: S  $\leq$ 0.06 mg/L, R >0.06 mg/L
- *Candida tropicalis*: S  $\leq$ 0.06 mg/L, R >0.06 mg/L
- *Candida parapsilosis*: S  $\leq$ 0.06 mg/L, R >0.06 mg/L
- *Candida dubliniensis*: S  $\leq$ 0.06 mg/L, R > 0.06 mg/L

There are currently insufficient data to set clinical breakpoints for other *Candida* species.

#### Combination with other antifungal agents

The use of combination antifungal therapies should not decrease the efficacy of either posaconazole or the other therapies; however, there is currently no clinical evidence that combination therapy will provide an added benefit.

## Clinical experience

### Summary of posaconazole concentrate for solution for infusion bridging study

Study 5520 was a non-comparative multi-center study performed to evaluate the pharmacokinetic properties, safety, and tolerability of posaconazole concentrate for solution for infusion.

Study 5520 enrolled a total of 279 subjects, including 268 receiving at least one dose of posaconazole concentrate for solution for infusion. Cohort 0 was designed to evaluate the tolerability of a single dose of posaconazole concentrate for solution for infusion when administered via a central line. The subject population for Cohorts 1 and 2 included subjects with AML or MDS who had recently received chemotherapy and had developed or were anticipated to develop significant neutropenia. Two different dosing groups were evaluated in Cohorts 1 and 2: 200 mg twice daily on Day 1, followed by 200 mg once daily thereafter (Cohort 1) and 300 mg twice daily on Day 1, followed by 300 mg once daily thereafter (Cohort 2).

The subject population in Cohort 3 included: 1) patients with AML or MDS who had recently received chemotherapy and had developed or were anticipated to develop significant neutropenia, or 2) patients who had undergone a HSCT and were receiving immunosuppressive therapy for prevention or treatment of GVHD. These types of patients had been previously studied in a pivotal controlled study of posaconazole oral suspension. Based on the pharmacokinetics and safety results of Cohorts 1 and 2, all subjects in Cohort 3 received 300 mg twice daily on Day 1, followed by 300 mg once daily thereafter.

The total subject population had a mean age of 51 years (range = 18-82 years), 95 % were White, the major ethnicity was not Hispanic or Latino (92 %), and 55 % were male. The study treated 155 (65 %) subjects with AML or MDS, and 82 (35 %) subjects with HSCT, as the primary diseases at study entry.

Serial pharmacokinetic samples were collected on Day 1 and at steady-state on Day 14 for all Cohort 1 and 2 subjects and on Day 10 for a subset of Cohort 3 subjects. This serial pharmacokinetic analysis demonstrated that 94 % of the subjects treated with the 300 mg once daily dose attained steady state  $C_{av}$  between 500-2,500 ng/mL [ $C_{av}$  was the average concentration of posaconazole at steady state, calculated as AUC/dosing interval (24 hours)]. This exposure was selected based on pharmacokinetic/pharmacodynamic considerations with posaconazole oral suspension. Subjects who received 300 mg once daily achieved a mean  $C_{av}$  at steady state of 1,500 ng/mL.

### Summary of posaconazole concentrate for solution for infusion and tablet study invasive aspergillosis

The safety and efficacy of posaconazole for the treatment of patients with invasive aspergillosis was evaluated in a double-blind controlled study (study-69) in 575 patients with proven, probable, or possible invasive fungal infections per EORTC/MSG criteria.

Patients were treated with posaconazole (n=288) concentrate for solution for infusion or tablet given at a dose of 300 mg QD (BID on Day 1). Comparator patients were treated with voriconazole (n=287) given IV at a dose of 6 mg/kg BID Day 1 followed by 4 mg/kg BID of voriconazole (intravenous), or orally at a dose of 300 mg BID Day 1 followed by 200 mg BID. Median treatment duration was 67 days (posaconazole) and 64 days (voriconazole).

In the intent-to-treat (ITT) population (all subjects who received at least one dose of study drug), 288 patients received posaconazole and 287 patients received voriconazole. The full analysis set population (FAS) is the subset of all subjects within the ITT population who were classified by independent adjudication as having proven or probable invasive aspergillosis: 163 subjects for posaconazole and 171 subjects for voriconazole. The all-cause mortality and global clinical response in these two populations are presented in Table 3 and 4, respectively

**Table 3.** Posaconazole invasive aspergillosis treatment study 1: all-cause mortality at Day 42 and Day 84, in the ITT and FAS populations

Population	Posaconazole		Voriconazole		Difference* (95 % CI)
	N	n (%)	N	n (%)	
Mortality in ITT at Day 42	288	44 (15.3)	287	59 (20.6)	-5.3 % (-11.6, 1.0)
Mortality in ITT at Day 84	288	81 (28.1)	287	88 (30.7)	-2.5 % (-9.9, 4.9)
Mortality in FAS at Day 42	163	31 (19.0)	171	32 (18.7)	0.3% (-8.2, 8.8)
Mortality in FAS at Day 84	163	56 (34.4)	171	53 (31.0)	3.1% (-6.9, 13.1)

\* Adjusted treatment difference based on Miettinen and Nurminen's method stratified by randomisation factor (risk for mortality/poor outcome), using Cochran-Mantel-Haenszel weighting scheme.

**Table 4.** Posaconazole invasive aspergillosis treatment study 1: global clinical response at Week 6 and Week 12 in the FAS population

Population	Posaconazole		Voriconazole		Difference* (95 % CI)
	N	Success (%)	N	Success (%)	
Global clinical response in the FAS at 6 weeks	163	73 (44.8)	171	78 (45.6)	-0.6 % (-11.2, 10.1)
Global clinical response in the FAS at 12 weeks	163	69 (42.3)	171	79 (46.2)	-3.4 % (-13.9, 7.1)

\* Successful Global Clinical Response was defined as survival with a partial or complete response  
Adjusted treatment difference based on Miettinen and Nurminen's method stratified by randomisation factor (risk for mortality/poor outcome), using Cochran-Mantel-Haenszel weighting scheme.

Summary of gastro-resistant powder and solvent for oral suspension and concentrate for solution for infusion bridging study

The pharmacokinetics and safety of posaconazole concentrate for solution for infusion and gastro-resistant powder and solvent for oral suspension have been assessed in 115 paediatric subjects aged 2 to less than 18 years in a non-randomised, multi-centre, open-label, sequential dose-escalation study (Study 097). Immunocompromised paediatric subjects with known or expected neutropenia were exposed to posaconazole at 3.5 mg/kg, 4.5 mg/kg or 6.0 mg/kg daily (BID on Day 1). All 115 subjects initially received posaconazole concentrate for solution for infusion for at least 7 days, and 63 subjects were transitioned to gastro-resistant powder and solvent for oral suspension. The mean overall treatment duration (posaconazole concentrate for solution for infusion and gastro-resistant powder and solvent for oral suspension) of all treated subjects was 20.6 days (see section 5.2).

Summary of posaconazole oral suspension studies

*Invasive aspergillosis*

Oral posaconazole suspension 800 mg/day in divided doses was evaluated for the treatment of invasive aspergillosis in patients with disease refractory to amphotericin B (including liposomal formulations) or itraconazole or in patients who were intolerant of these medicinal products in a non-comparative salvage therapy study. Clinical outcomes were compared with those in an external control group derived from a retrospective review of medical records. The external control group included 86 patients treated with available therapy (as above) mostly at the same time and at the same sites as the patients treated with posaconazole. Most of the cases of aspergillosis were considered to be refractory to prior therapy in both the posaconazole group (88 %) and in the external control group (79 %).

As shown in Table 5 a successful response (complete or partial resolution) at the end of treatment was seen in 42 % of posaconazole-treated patients compared to 26 % of the external group. However, this



was not a prospective, randomised controlled study and so all comparisons with the external control group should be viewed with caution.

**Table 5.** Overall efficacy of posaconazole oral suspension at the end of treatment for invasive aspergillosis in comparison to an external control group

	<b>Posaconazole oral suspension</b>	<b>External control group</b>
Overall Response	45/107 (42 %)	22/86 (26 %)
<b>Success by Species</b>		
All mycologically confirmed <i>Aspergillus</i> spp. <sup>3</sup>		
<i>A. fumigatus</i>	34/76 (45 %)	19/74 (26 %)
<i>A. flavus</i>	12/29 (41 %)	12/34 (35 %)
<i>A. terreus</i>	10/19 (53 %)	3/16 (19 %)
<i>A. niger</i>	4/14 (29 %)	2/13 (15 %)
	3/5 (60 %)	2/7 (29 %)

#### *Fusarium* spp.

11 of 24 patients who had proven or probable fusariosis were successfully treated with posaconazole oral suspension 800 mg/day in divided doses for a median of 124 days and up to 212 days. Among eighteen patients who were intolerant or had infections refractory to amphotericin B or itraconazole, seven patients were classed as responders.

#### *Chromoblastomycosis/Mycetoma*

9 of 11 patients were successfully treated with posaconazole oral suspension 800 mg/day in divided doses for a median of 268 days and up to 377 days. Five of these patients had chromoblastomycosis due to *Fonsecaea pedrosoi* and 4 had mycetoma, mostly due to *Madurella* species.

#### *Coccidioidomycosis*

11 of 16 patients were successfully treated (at the end of treatment complete or partial resolution of signs and symptoms present at baseline) with posaconazole oral suspension 800 mg/day in divided doses for a median of 296 days and up to 460 days.

#### *Prophylaxis of Invasive Fungal Infections (IFIs) (Studies 316 and 1899)*

Two randomised, controlled prophylaxis studies were conducted among patients at high-risk for developing invasive fungal infections.

Study 316 was a randomised, double-blind study of posaconazole oral suspension (200 mg three times a day) versus fluconazole capsules (400 mg once daily) in allogeneic hematopoietic stem cell transplant recipients with graft-versus-host disease (GVHD). The primary efficacy endpoint was the incidence of proven/probable IFIs at 16 weeks post-randomisation as determined by an independent, blinded external expert panel. A key secondary endpoint was the incidence of proven/probable IFIs during the on-treatment period (first dose to last dose of study medicinal product + 7 days). The majority (377/600, [63 %]) of patients included had Acute Grade 2 or 3 or chronic extensive (195/600, [32.5 %]) GVHD at study start. The mean duration of therapy was 80 days for posaconazole and 77 days for fluconazole.

Study 1899 was a randomised, evaluator-blinded study of posaconazole oral suspension (200 mg three times a day) versus fluconazole suspension (400 mg once daily) or itraconazole oral solution (200 mg twice a day) in neutropenic patients who were receiving cytotoxic chemotherapy for acute myelogenous leukaemia or myelodysplastic syndromes. The primary efficacy endpoint was the incidence of proven/probable IFIs as determined by an independent, blinded external expert panel during the on-treatment period. A key secondary endpoint was the incidence of proven/probable IFIs at 100 days post-randomisation. New diagnosis of acute myelogenous leukaemia was the most

<sup>3</sup> Includes other less common species or species unknown

common underlying condition (435/602, [72 %]). The mean duration of therapy was 29 days for posaconazole and 25 days for fluconazole/itraconazole.

In both prophylaxis studies, aspergillosis was the most common breakthrough infection. See Table 6 and 7 for results from both studies. There were fewer breakthrough *Aspergillus* infections in patients receiving posaconazole prophylaxis when compared to control patients.

**Table 6.** Results from clinical studies in prophylaxis of Invasive Fungal Infections

Study	Posaconazole oral suspension	Control <sup>a</sup>	P-Value
<b>Proportion (%) of patients with proven/probable IFIs</b>			
<b>On-treatment period<sup>b</sup></b>			
1899 <sup>d</sup>	7/304 (2)	25/298 (8)	0.0009
316 <sup>e</sup>	7/291 (2)	22/288 (8)	0.0038
<b>Fixed-time period<sup>c</sup></b>			
1899 <sup>d</sup>	14/304 (5)	33/298 (11)	0.0031
316 <sup>d</sup>	16/301 (5)	27/299 (9)	0.0740

FLU = fluconazole; ITZ = itraconazole; POS = posaconazole.

a: FLU/ITZ (1899); FLU (316).

b: In 1899 this was the period from randomisation to last dose of study medicinal product plus 7 days; in 316 it was the period from first dose to last dose of study medicinal product plus 7 days.

c: In 1899, this was the period from randomisation to 100 days post-randomisation; in 316 it was the period from the baseline day to 111 days post-baseline.

d: All randomised

e: All treated

**Table 7.** Results from clinical studies in prophylaxis of Invasive Fungal Infections

Study	Posaconazole oral suspension	Control <sup>a</sup>
<b>Proportion (%) of patients with proven/probable Aspergillosis</b>		
<b>On-treatment period<sup>b</sup></b>		
1899 <sup>d</sup>	2/304 (1)	20/298 (7)
316 <sup>e</sup>	3/291 (1)	17/288 (6)
<b>Fixed-time period<sup>c</sup></b>		
1899 <sup>d</sup>	4/304 (1)	26/298 (9)
316 <sup>d</sup>	7/301 (2)	21/299 (7)

FLU = fluconazole; ITZ = itraconazole; POS = posaconazole.

a: FLU/ITZ (1899); FLU (316).

b: In 1899 this was the period from randomisation to last dose of study medicinal product plus 7 days; in 316 it was the period from first dose to last dose of study medicinal product plus 7 days.

c: In 1899, this was the period from randomisation to 100 days post-randomisation; in 316 it was the period from the baseline day to 111 days post-baseline.

d: All randomised

e: All treated

In Study 1899, a significant decrease in all cause mortality in favour of posaconazole was observed [POS 49/304 (16 %) vs. FLU/ITZ 67/298 (22 %) p= 0.048]. Based on Kaplan-Meier estimates, the probability of survival up to day 100 after randomisation, was significantly higher for posaconazole recipients; this survival benefit was demonstrated when the analysis considered all causes of death (P= 0.0354) as well as IFI-related deaths (P = 0.0209).

In Study 316, overall mortality was similar (POS, 25 %; FLU, 28 %); however, the proportion of IFI-related deaths was significantly lower in the POS group (4/301) compared with the FLU group (12/299; P= 0.0413).

### Paediatric population

There is limited paediatric experience for posaconazole concentrate for solution for infusion.

Three patients 14-17 years of age were treated with posaconazole concentrate for solution for infusion and tablet 300 mg/day (BID on Day 1 followed by QD thereafter) in the study of treatment of invasive aspergillosis.

The safety and efficacy of posaconazole (Noxafil gastro-resistant powder and solvent for oral suspension; Noxafil concentrate for solution for infusion) have been established in paediatric patients 2 to less than 18 years of age. Use of posaconazole in these age groups is supported by evidence from adequate and well-controlled studies of posaconazole in adults and pharmacokinetic and safety data from paediatric studies (see section 5.2). No new safety signals associated with the use of posaconazole in paediatric patients were identified in the paediatric studies (see section 4.8).

Safety and efficacy of Noxafil in paediatric patients below the age of 2 years have not been established.

No data are available.

### Electrocardiogram evaluation

Multiple, time-matched ECGs collected over a 12 hour period were obtained before and during administration of posaconazole oral suspension (400 mg twice daily with high fat meals) from 173 healthy male and female volunteers aged 18 to 85 years. No clinically relevant changes in the mean QTc (Fridericia) interval from baseline were observed.

## **5.2 Pharmacokinetic properties**

### Pharmacokinetic / Pharmacodynamic relationships

A correlation between total medicinal product exposure divided by MIC (AUC/MIC) and clinical outcome was observed. The critical ratio for subjects with *Aspergillus* infections was ~200. It is particularly important to try to ensure that maximal plasma levels are achieved in patients infected with *Aspergillus* (see sections 4.2 and 5.2 on recommended dose regimens).

### Distribution

Following administration of 300 mg posaconazole concentrate for solution for infusion over 90 minutes, mean peak plasma concentration at the end of infusion was 3,280 ng/mL (74 % CV). Posaconazole exhibits dose proportional pharmacokinetics after single and multiple dosing in the therapeutic dose range (200-300 mg). Posaconazole has a distribution volume of 261 L, indicating extravascular distribution.

Posaconazole is highly protein bound (> 98 %), predominantly to serum albumin.

### Biotransformation

Posaconazole does not have any major circulating metabolites. Of the circulating metabolites, the majority are glucuronide conjugates of posaconazole with only minor amounts of oxidative (CYP450 mediated) metabolites observed. The excreted metabolites in urine and faeces account for approximately 17 % of the administered radiolabelled dose of posaconazole oral suspension.

### Elimination

Posaconazole, after administration of 300 mg of posaconazole concentrate for solution for infusion, is slowly eliminated with a mean half-life ( $t_{1/2}$ ) of 27 hours and a mean clearance of 7.3 L/hr. After administration of  $^{14}\text{C}$ -posaconazole as oral suspension, radioactivity was predominantly recovered in the faeces (77 % of the radiolabelled dose) with the major component being parent compound (66 % of the radiolabelled dose). Renal clearance is a minor elimination pathway, with 14 % of the radiolabelled dose excreted in urine (< 0.2 % of the radiolabelled dose is parent compound). Steady-state plasma concentrations are attained by Day 6 at the 300 mg dose (once daily after twice daily loading dose at Day 1).

Posaconazole plasma concentrations following administration of posaconazole concentrate for solution for infusion single dose increased in a greater than dose proportional manner over the range of 50-200 mg; by comparison, dose-dependent increases were observed over a range of 200-300 mg.

#### Pharmacokinetics in special populations

Based on a population pharmacokinetic model evaluating posaconazole pharmacokinetics, steady state posaconazole concentrations were predicted in patients administered posaconazole concentrate for solution for infusion or tablets 300 mg once a day following BID dosing on Day 1 for the treatment of invasive aspergillosis and prophylaxis of invasive fungal infections.

**Table 8.** Population predicted median (10<sup>th</sup> percentile, 90<sup>th</sup> percentile) posaconazole steady state plasma concentrations in patients following administration of posaconazole concentrate for solution for infusion or tablets 300 mg QD (BID on Day 1)

Regimen	Population	C <sub>av</sub> (ng/mL)	C <sub>min</sub> (ng/mL)
Tablet- (Fasted)	Prophylaxis	1,550 (874; 2,690)	1,330 (667; 2,400)
	Treatment of Invasive Aspergillosis	1,780 (879; 3,540)	1,490 (663; 3,230)
Concentrate for Solution for Infusion	Prophylaxis	1,890 (1,100; 3,150)	1,500 (745; 2,660)
	Treatment of Invasive Aspergillosis	2,240 (1,230; 4,160)	1,780 (874; 3,620)

The population pharmacokinetic analysis of posaconazole in patients suggests that race, sex, renal impairment and disease (prophylaxis or treatment) have no clinically meaningful effect on the pharmacokinetics of posaconazole.

#### Children (< 18 years)

There is limited (n=3) paediatric experience with posaconazole concentrate for solution for infusion in the study of treatment of invasive aspergillosis (see sections 4.2 and 5.3).

The mean pharmacokinetic parameters after multiple dose administration of posaconazole concentrate for solution for infusion and posaconazole gastro-resistant powder and solvent for oral suspension in neutropenic paediatric patients 2 to less than 18 years of age are shown in Table 9. Patients were enrolled into 2 age groups and received posaconazole concentrate for solution for infusion and posaconazole gastro-resistant powder and solvent for oral suspension doses at 6 mg/kg (maximum 300 mg) once daily (twice daily on Day 1) (see section 5.1).

**Table 9.** Summary of Steady-State Geometric Mean Pharmacokinetic Parameters (% Geometric CV) After Multiple Dosing with Posaconazole Concentrate for Solution for Infusion and Posaconazole Gastro-Resistant Powder and Solvent for Oral Suspension 6 mg/kg in Paediatric Patients with Neutropenia or Expected Neutropenia

Age Group	Dose Type	N	AUC <sub>0-24 hours</sub> (ng·hr/mL)	C <sub>av</sub> * (ng/mL)	C <sub>max</sub> (ng/mL)	C <sub>min</sub> (ng/mL)	T <sub>max</sub> <sup>†</sup> (hr)	CL/F <sup>‡</sup> (L/hr)
2 to <7 years	IV	17	31,100 (48.9)	1,300 (48.9)	3,060 (54.1)	626 (104.8)	1.75 (1.57- 1.83)	3.27 (49.3)
	PFS	7	23,000 (47.3)	960 (47.3)	1,510 (43.4)	542 (68.8)	4.00 (2.17- 7.92)	4.60 (35.2)
7 to	IV	24	44,200	1,840	3,340	1,160	1.77 (1.33-	4.76

Age Group	Dose Type	N	AUC <sub>0-24 hours</sub> (ng·hr/mL)	C <sub>av</sub> * (ng/mL)	C <sub>max</sub> (ng/mL)	C <sub>min</sub> (ng/mL)	T <sub>max</sub> † (hr)	CL/F‡ (L/hr)
17 years			(41.5)	(41.5)	(39.4)	(60.4)	6.00	(55.7)
	PFS	12	25,000 (184.3)	1,040 (184.3)	1,370 (178.5)	713 (300.6)	2.78 (0.00-4.00)	8.39 (190.3)

IV= posaconazole concentrate for solution for infusion; PFS=posaconazole gastro-resistant powder and solvent for oral suspension; AUC<sub>0-24 hours</sub> = Area under the plasma concentration-time curve from time zero to 24 hr; C<sub>max</sub> = maximum observed concentration; C<sub>min</sub> = minimum observed plasma concentration; T<sub>max</sub> = time of maximum observed concentration; CL /F = apparent total body clearance  
\* C<sub>av</sub> = time-averaged concentrations (i.e., AUC<sub>0-24 hours</sub>/24hr)  
† Median (minimum-maximum)  
‡ Clearance (CL for IV and CL/F for PFS)

Based on a population pharmacokinetic model evaluating posaconazole pharmacokinetics and predicting exposures in paediatric patients, the exposure target of steady-state posaconazole average concentration (C<sub>av</sub>) of approximately 1,200 ng/mL and C<sub>av</sub> ≥ 500 ng/mL in approximately 90 % of patients is attained with the recommended dose of posaconazole concentrate for solution for infusion and gastro-resistant powder and solvent for oral suspension. Simulations, using the population pharmacokinetic model, predict a C<sub>av</sub> ≥ 500 ng/mL in 90% of paediatric patients weighing at least 40 kg following administration of the adult dose of posaconazole gastro-resistant tablets (300 mg twice daily on Day 1 and 300 mg once daily starting on Day 2).

The population pharmacokinetic analysis of posaconazole in paediatric patients suggests that age, sex, renal impairment and ethnicity have no clinically meaningful effect on the pharmacokinetics of posaconazole.

#### *Gender*

The pharmacokinetics of posaconazole concentration for solution for infusion are comparable in men and women.

#### *Elderly*

No overall differences in safety were observed between the geriatric patients and younger patients.

The population pharmacokinetic model of posaconazole concentrate for solution for infusion and tablets indicates that posaconazole clearance is related to age. Posaconazole C<sub>av</sub> is generally comparable between young and elderly patients (≥ 65 years of age); however, the C<sub>av</sub> is increased by 11 % in the very elderly (≥ 80 years). It is, therefore, suggested to closely monitor very elderly patients (≥ 80 years) for adverse events.

The pharmacokinetics of posaconazole concentrate for solution for infusion are comparable in young and elderly subjects (≥ 65 years of age).

Pharmacokinetic differences based upon age are not to be considered clinically relevant; therefore, no dose adjustment is required.

#### *Race*

There is insufficient data among different races with posaconazole concentrate for solution for infusion.

There was a slight decrease (16 %) in the AUC and C<sub>max</sub> of posaconazole oral suspension in Black subjects relative to Caucasian subjects. However, the safety profile of posaconazole between the Black and Caucasian subjects was similar.

### *Weight*

The population pharmacokinetic model of posaconazole concentrate for solution for infusion and tablets indicates that posaconazole clearance is related to weight. In patients > 120 kg, the  $C_{av}$  is decreased by 25 % and in patients < 50 kg, the  $C_{av}$  is increased by 19 %.

It is, therefore, suggested to closely monitor for breakthrough fungal infections in patients weighing more than 120 kg.

### *Renal impairment*

Following single-dose administration of posaconazole oral suspension, there was no effect of mild and moderate renal impairment ( $n=18$ ,  $Cl_{cr} \geq 20$  mL/min/1.73 m<sup>2</sup>) on posaconazole pharmacokinetics; therefore, no dose adjustment is required. In subjects with severe renal impairment ( $n=6$ ,  $Cl_{cr} < 20$  mL/min/1.73 m<sup>2</sup>), the AUC of posaconazole was highly variable [ $> 96$  % CV (coefficient of variance)] compared to other renal groups [ $< 40$  % CV]. However, as posaconazole is not significantly renally eliminated, an effect of severe renal impairment on the pharmacokinetics of posaconazole is not expected and no dose adjustment is recommended. Posaconazole is not removed by haemodialysis. Due to the variability in exposure, patients with severe renal impairment should be monitored closely for breakthrough fungal infections (see section 4.2).

Similar recommendations apply to posaconazole concentrate for solution for infusion; however, a specific study has not been conducted with posaconazole concentrate for solution for infusion.

### *Hepatic impairment*

After a single oral dose of 400 mg posaconazole oral suspension to patients with mild (Child-Pugh Class A), moderate (Child-Pugh Class B) or severe (Child-Pugh Class C) hepatic impairment (six per group), the mean AUC was 1.3 to 1.6-fold higher compared to that for matched control subjects with normal hepatic function. Unbound concentrations were not determined and it cannot be excluded that there is a larger increase in unbound posaconazole exposure than the observed 60 % increase in total AUC. The elimination half-life ( $t_{1/2}$ ) was prolonged from approximately 27 hours up to ~43 hours in respective groups. No dose adjustment is recommended for patients with mild to severe hepatic impairment but caution is advised due to the potential for higher plasma exposure.

Similar recommendations apply to posaconazole concentrate for solution for infusion; however, a specific study has not been conducted with posaconazole concentrate for solution for infusion.

## **5.3 Preclinical safety data**

As observed with other azole antifungal agents, effects related to inhibition of steroid hormone synthesis were seen in repeated-dose toxicity studies with posaconazole. Adrenal suppressive effects were observed in toxicity studies in rats and dogs at exposures equal to or greater than those obtained at therapeutic doses in humans.

Neuronal phospholipidosis occurred in dogs dosed for  $\geq 3$  months at lower systemic exposures than those obtained at therapeutic doses in humans. This finding was not seen in monkeys dosed for one year. In twelve-month neurotoxicity studies in dogs and monkeys, no functional effects were observed on the central or peripheral nervous systems at systemic exposures greater than those achieved therapeutically.

Pulmonary phospholipidosis resulting in dilatation and obstruction of the alveoli was observed in the 2-year study in rats. These findings are not necessarily indicative of a potential for functional changes in humans.

No effects on electrocardiograms, including QT and QTc intervals, were seen in a repeat dose safety pharmacology study in monkeys at maximal plasma concentrations 8.9-fold greater than the concentrations obtained at therapeutic doses in humans with 300 mg intravenous infusion administration. Echocardiography revealed no indication of cardiac decompensation in a repeat dose safety pharmacology study in rats at a systemic exposure 2.2-fold greater than that achieved therapeutically. Increased systolic and arterial blood pressures (up to 29 mm-Hg) were seen in rats and

monkeys at systemic exposures 2.2-fold and 8.9-fold greater, respectively, than those achieved with the human therapeutic doses.

A non-dose related incidence of thrombus/emboli in the lung was seen in the 1 month repeated dose study in the monkey. The clinical significance of this finding is unknown.

Reproduction, peri- and postnatal development studies were conducted in rats. At exposures lower than those obtained at therapeutic doses in humans, posaconazole caused skeletal variations and malformations, dystocia, increased length of gestation, reduced mean litter size and postnatal viability. In rabbits, posaconazole was embryotoxic at exposures greater than those obtained at therapeutic doses. As observed with other azole antifungal agents, these effects on reproduction were considered to be due to a treatment-related effect on steroidogenesis.

Posaconazole was not genotoxic in *in vitro* and *in vivo* studies. Carcinogenicity studies did not reveal special hazards for humans.

In a nonclinical study using intravenous administration of posaconazole in very young dogs (dosed from 2-8 weeks of age) an increase in the incidence of brain ventricle enlargement was observed in treated animals as compared with concurrent control animals. No difference in the incidence of brain ventricle enlargement between control and treated animals was observed following the subsequent 5-month treatment-free period. There were no neurologic, behavioural or developmental abnormalities in the dogs with this finding, and a similar brain finding was not seen with either oral posaconazole administration to juvenile dogs (4 days to 9 months of age) or intravenous posaconazole administration to juvenile dogs (10 weeks to 23 weeks of age). The clinical significance of this finding is unknown.

## **6. PHARMACEUTICAL PARTICULARS**

### **6.1 List of excipients**

Betadex Sulfobutyl Ether Sodium (SBECD)  
Disodium edetate  
Hydrochloric acid [for pH adjustment]  
Sodium hydroxide [for pH adjustment]  
Water for injections

### **6.2 Incompatibilities**

Noxafil must not be diluted with:

Lactated Ringer's solution
5 % glucose with Lactated Ringer's solution
4.2 % sodium bicarbonate

This medicinal product must not be mixed with other medicinal products except those mentioned in section 6.6.

### **6.3 Shelf life**

3 years

From a microbiological point of view, once admixed, the product should be used immediately. If not used immediately, the solution can be stored up to 24 hours refrigerated 2°C-8°C. This medicinal product is for single use only.

### **6.4 Special precautions for storage**

Store in a refrigerator (2°C-8°C).

For storage conditions after dilution of the medicinal product, see section 6.3.

## 6.5 Nature and contents of container

Type I glass vial closed with bromobutyl rubber stopper and aluminium seal containing 16.7 mL of solution.

Pack size: 1 vial

## 6.6 Special precautions for disposal and other handling

Administration instructions for Noxafil concentrate for solution for infusion

- Equilibrate the refrigerated vial of Noxafil to room temperature.
- Aseptically transfer 16.7 mL of posaconazole to an intravenous bag (or bottle) containing a compatible admixture diluent (see below for list of diluents) using the volume ranging from 150 mL to 283 mL depending on the final concentration to be achieved (not less than 1 mg/mL and not greater than 2 mg/mL).
- Administer via a central venous line, including a central venous catheter or peripherally inserted central catheter (PICC) by slow intravenous infusion over approximately 90 minutes. Noxafil concentrate for solution for infusion should not be given by bolus administration.
- If a central venous catheter is not available, a single infusion may be administered through a peripheral venous catheter with a volume to achieve a dilution of approximately 2 mg/mL. When administered through a peripheral venous catheter, the infusion should be administered over approximately 30 minutes.  
**Note: In clinical studies, multiple peripheral infusions given through the same vein resulted in infusion site reactions (see section 4.8).**
- Noxafil is for single use.

The following medicinal products can be infused at the same time through the same intravenous line (or cannula) as Noxafil concentrate for solution for infusion:

Amikacin sulfate
Caspofungin
Ciprofloxacin
Daptomycin
Dobutamine hydrochloride
Famotidine
Filgrastim
Gentamicin sulfate
Hydromorphone hydrochloride
Levofloxacin
Lorazepam
Meropenem
Micafungin
Morphine sulphate
Norepinephrine bitartrate
Potassium chloride
Vancomycin hydrochloride

Any products not listed in the table above should not be coadministered with Noxafil through the same intravenous line (or cannula).

Noxafil concentrate for solution for infusion should be inspected visually for particulate matter prior to administration. The solution of Noxafil ranges from colourless to pale yellow. Variations of colour within this range do not affect the quality of the product.



Any unused medicinal product or waste material should be disposed of in accordance with local requirements.

This medicinal product must not be mixed with other medicinal products except those mentioned below:

5 % glucose in water  
0.9 % sodium chloride  
0.45 % sodium chloride  
5 % glucose and 0.45 % sodium chloride  
5 % glucose and 0.9 % sodium chloride  
5 % glucose and 20 mEq KCl

## **7. MARKETING AUTHORISATION HOLDER**

Merck Sharp & Dohme B.V.  
Waarderweg 39  
2031 BN Haarlem  
The Netherlands

## **8. MARKETING AUTHORISATION NUMBER(S)**

EU/1/05/320/004      1 vial

## **9. DATE OF FIRST AUTHORISATION/RENEWAL OF THE AUTHORISATION**

Date of first authorisation: 25 October 2005  
Date of latest renewal: 25 October 2010

## **10. DATE OF REVISION OF THE TEXT**

<{MM/YYYY}>

Detailed information on this medicinal product is available on the website of the European Medicines Agency <http://www.ema.europa.eu>.

## 1. NAME OF THE MEDICINAL PRODUCT

Noxafil 300 mg gastro-resistant powder and solvent for oral suspension

## 2. QUALITATIVE AND QUANTITATIVE COMPOSITION

Each sachet contains 300 mg of posaconazole. Following reconstitution, the gastro-resistant oral suspension has a concentration of approximately 30 mg per mL.

### Excipients with known effect

This medicinal product contains 0.28 mg/mL methyl parahydroxybenzoate (E218) and 0.04 mg/mL propyl parahydroxybenzoate.

This medicinal product contains 47 mg of sorbitol (E420) per mL.

This medicinal product contains 7 mg of propylene glycol (E1520) per mL.

For the full list of excipients, see section 6.1.

## 3. PHARMACEUTICAL FORM

Gastro-resistant powder and solvent for oral suspension.

Off-white to yellow powder.

The solvent is a cloudy, colourless liquid.

## 4. CLINICAL PARTICULARS

### 4.1 Therapeutic indications

Noxafil gastro-resistant powder and solvent for oral suspension is indicated for use in the treatment of the following fungal infections in paediatric patients from 2 years of age (see sections 4.2 and 5.1):

- Invasive aspergillosis in patients with disease that is refractory to amphotericin B or itraconazole or in patients who are intolerant of these medicinal products;
- Fusariosis in patients with disease that is refractory to amphotericin B or in patients who are intolerant of amphotericin B;
- Chromoblastomycosis and mycetoma in patients with disease that is refractory to itraconazole or in patients who are intolerant of itraconazole;
- Coccidioidomycosis in patients with disease that is refractory to amphotericin B, itraconazole or fluconazole or in patients who are intolerant of these medicinal products.

Refractoriness is defined as progression of infection or failure to improve after a minimum of 7 days of prior therapeutic doses of effective antifungal therapy.

Noxafil gastro-resistant powder and solvent for oral suspension is indicated for prophylaxis of invasive fungal infections in the following paediatric patients from 2 years of age:

- Patients receiving remission-induction chemotherapy for acute myelogenous leukaemia (AML) or myelodysplastic syndromes (MDS) expected to result in prolonged neutropenia and who are at high-risk of developing invasive fungal infections;
- Haematopoietic stem cell transplant (HSCT) recipients who are undergoing high-dose immunosuppressive therapy for graft versus host disease and who are at high-risk of developing invasive fungal infections.

Please refer to the Summary of Product Characteristics of Noxafil concentrate for solution for infusion and the gastro-resistant tablets for use in primary treatment of invasive aspergillosis.

Please refer to the Summary of Product Characteristics of Noxafil oral suspension for use in oropharyngeal candidiasis.

## 4.2 Posology and method of administration

### Non-interchangeability between Noxafil gastro-resistant powder and solvent for oral suspension and Noxafil oral suspension

Noxafil gastro-resistant powder and solvent for oral suspension is indicated for paediatric population (<18 years old) only. Another formulation (Noxafil oral suspension) is available for adult patients  $\geq 18$  years old.

The gastro-resistant powder and solvent for oral suspension is not to be used interchangeably with oral suspension due to the differences in the dosing of each formulation. Therefore, follow the specific dose recommendations for each of the formulations.

Treatment should be initiated by a physician experienced in the management of fungal infections or in the supportive care of high-risk patients for which posaconazole is indicated as prophylaxis.

#### Posology

Noxafil is also available as 40 mg/mL oral suspension; 100 mg gastro-resistant tablet; and 300 mg concentrate for solution for infusion.

Dosing for paediatric patients 2 years to less than 18 years of age is shown in Table 1.

The maximum dose volume that can be administered with a 10 mL dosing syringe is 8 mL using one marketed sachet of Noxafil gastro-resistant powder and solvent for oral suspension, corresponding to a maximum dose of 240 mg (i.e., the recommended dose for patients weighing 40 kg). For paediatric patients weighing > 40 kg, it is recommended to use posaconazole tablets if the patient can swallow whole tablets. Refer to the tablet SmPC for additional dosing information.

**Table 1.** Recommended dose in paediatric patients (2 years to less than 18 years of age) and weighing 10 to 40 kg

<b>Weight (kg)</b>	<b>Dose (volume)</b>
10-<12 kg	90 mg (3 mL)
12-<17 kg	120 mg (4 mL)
17-<21 kg	150 mg (5 mL)
21-<26 kg	180 mg (6 mL)
26-<36 kg	210 mg (7 mL)
36-40 kg	240 mg (8 mL)

On Day 1, the recommended dose is administered twice.

After Day 1, the recommended dose is administered once daily.

#### *Duration of therapy*

For patients with refractory invasive fungal infections (IFI) or patients with IFI intolerant to 1<sup>st</sup> line therapy, the duration of therapy should be based on the severity of the underlying disease, recovery from immunosuppression, and clinical response.

For patients with acute myelogenous leukaemia or myelodysplastic syndromes, prophylaxis of invasive fungal infections with Noxafil should start several days before the anticipated onset of neutropenia and continue for 7 days after the neutrophil count rises above 500 cells per mm<sup>3</sup>. Duration of therapy is based on recovery from neutropenia or immunosuppression.

#### Special populations

##### *Renal impairment*

An effect of renal impairment on the pharmacokinetics of posaconazole is not expected and no dose adjustment is recommended (see section 5.2).

### *Hepatic impairment*

Limited data on the effect of hepatic impairment (including Child-Pugh C classification of chronic liver disease) on the pharmacokinetics of posaconazole demonstrate an increase in plasma exposure compared to subjects with normal hepatic function, but do not suggest that dose adjustment is necessary (see sections 4.4 and 5.2). It is recommended to exercise caution due to the potential for higher plasma exposure.

### *Paediatric population*

The safety and efficacy of posaconazole in children aged below 2 years have not been established. No clinical data are available.

### Method of administration

For oral use

The dose should be administered orally within 30 minutes of mixing.

Noxafil gastro-resistant powder and solvent for oral suspension must be administered with the provided notched tip syringes.

For details on preparation and administration of the gastro-resistant powder and solvent for oral suspension, see section 6.6 and Instructions for Use.

Noxafil gastro-resistant powder and solvent for oral suspension may be taken with or without food (see section 5.2).

## **4.3 Contraindications**

Hypersensitivity to the active substance or to any of the excipients listed in section 6.1.

Co-administration with ergot alkaloids (see section 4.5).

Co-administration with the CYP3A4 substrates terfenadine, astemizole, cisapride, pimozone, halofantrine or quinidine since this may result in increased plasma concentrations of these medicinal products, leading to QTc prolongation and rare occurrences of torsades de pointes (see sections 4.4 and 4.5).

Co-administration with the HMG-CoA reductase inhibitors simvastatin, lovastatin and atorvastatin (see section 4.5).

Co-administration during the initiation and dose-titration phase of venetoclax in Chronic Lymphocytic Leukaemia (CLL) patients (see sections 4.4 and 4.5).

## **4.4 Special warnings and precautions for use**

### Hypersensitivity

There is no information regarding cross-sensitivity between posaconazole and other azole antifungal agents. Caution should be used when prescribing posaconazole to patients with hypersensitivity to other azoles.

### Hepatic toxicity

Hepatic reactions (e.g. mild to moderate elevations in ALT, AST, alkaline phosphatase, total bilirubin and/or clinical hepatitis) have been reported during treatment with posaconazole. Elevated liver function tests were generally reversible on discontinuation of therapy and in some instances these tests normalised without interruption of therapy. Rarely, more severe hepatic reactions with fatal outcomes have been reported.

Posaconazole should be used with caution in patients with hepatic impairment due to limited clinical experience and the possibility that posaconazole plasma levels may be higher in these patients (see sections 4.2 and 5.2).

### Monitoring of hepatic function

Liver function tests should be evaluated at the start of and during the course of posaconazole therapy. Patients who develop abnormal liver function tests during posaconazole therapy must be routinely monitored for the development of more severe hepatic injury. Patient management should include laboratory evaluation of hepatic function (particularly liver function tests and bilirubin). Discontinuation of posaconazole should be considered if clinical signs and symptoms are consistent with development of liver disease.

### QTc prolongation

Some azoles have been associated with prolongation of the QTc interval. Posaconazole must not be administered with medicinal products that are substrates for CYP3A4 and are known to prolong the QTc interval (see sections 4.3 and 4.5). Posaconazole should be administered with caution to patients with pro-arrhythmic conditions such as:

- Congenital or acquired QTc prolongation
- Cardiomyopathy, especially in the presence of cardiac failure
- Sinus bradycardia
- Existing symptomatic arrhythmias
- Concomitant use with medicinal products known to prolong the QTc interval (other than those mentioned in section 4.3).

Electrolyte disturbances, especially those involving potassium, magnesium or calcium levels, should be monitored and corrected as necessary before and during posaconazole therapy.

### Drug interactions

Posaconazole is an inhibitor of CYP3A4 and should only be used under specific circumstances during treatment with other medicinal products that are metabolised by CYP3A4 (see section 4.5).

### Midazolam and other benzodiazepines

Due to the risk of prolonged sedation and possible respiratory depression co-administration of posaconazole with any benzodiazepines metabolised by CYP3A4 (e.g. midazolam, triazolam, alprazolam) should only be considered if clearly necessary. Dose adjustment of benzodiazepines metabolised by CYP3A4 should be considered (see section 4.5).

### Vincristine toxicity

Concomitant administration of azole antifungals, including posaconazole, with vincristine has been associated with neurotoxicity and other serious adverse reactions, including seizures, peripheral neuropathy, syndrome of inappropriate antidiuretic hormone secretion, and paralytic ileus. Reserve azole antifungals, including posaconazole, for patients receiving a vinca alkaloid, including vincristine, who have no alternative antifungal treatment options (see section 4.5).

### Venetoclax toxicity

Concomitant administration of strong CYP3A inhibitors, including posaconazole, with the CYP3A4 substrate venetoclax, may increase venetoclax toxicities, including the risk of tumour lysis syndrome (TLS) and neutropenia (see sections 4.3 and 4.5). Refer to the venetoclax SmPC for detailed guidance.

### Rifamycin antibacterials (rifampicin, rifabutin), certain anticonvulsants (phenytoin, carbamazepine, phenobarbital, primidone), and efavirenz

Posaconazole concentrations may be significantly lowered in combination; therefore, concomitant use with posaconazole should be avoided unless the benefit to the patient outweighs the risk (see section 4.5).

### Plasma exposure

Posaconazole plasma concentrations following administration of posaconazole tablets are generally higher than those obtained with posaconazole oral suspension. Posaconazole plasma concentrations following administration of posaconazole tablets may increase over time in some patients (see section 5.2).

### Gastrointestinal dysfunction

There are limited pharmacokinetic data in patients with severe gastrointestinal dysfunction (such as severe diarrhoea). Patients who have severe diarrhoea or vomiting should be monitored closely for breakthrough fungal infections.

### Methyl parahydroxybenzoate and propyl parahydroxybenzoate

This medicinal product contains methyl parahydroxybenzoate (E218) and propyl parahydroxybenzoate. May cause allergic reactions (possibly delayed).

### Sorbitol

This medicine contains 47 mg sorbitol (E420) per mL.

In medicinal products for oral use, sorbitol may affect the bioavailability of other medicinal products for oral use administered concomitantly.

Patients with hereditary fructose intolerance (HFI) should not take/be given this medicinal product.

### Propylene glycol

This medicine contains 7 mg propylene glycol (E1520) per mL.

### Sodium

This medicinal product contains less than 1 mmol sodium (23 mg) per dose, that is to say essentially 'sodium-free'.

## **4.5 Interaction with other medicinal products and other forms of interaction**

### Effects of other medicinal products on posaconazole

Posaconazole is metabolised via UDP glucuronidation (phase 2 enzymes) and is a substrate for p-glycoprotein (P-gp) efflux *in vitro*. Therefore, inhibitors (e.g. verapamil, ciclosporin, quinidine, clarithromycin, erythromycin, etc.) or inducers (e.g. rifampicin, rifabutin, certain anticonvulsants, etc.) of these clearance pathways may increase or decrease posaconazole plasma concentrations, respectively.

#### *Rifabutin*

Rifabutin (300 mg once a day) decreased the  $C_{max}$  (maximum plasma concentration) and AUC (area under the plasma concentration time curve) of posaconazole to 57 % and 51 %, respectively.

Concomitant use of posaconazole and rifabutin and similar inducers (e.g. rifampicin) should be avoided unless the benefit to the patient outweighs the risk. See also below regarding the effect of posaconazole on rifabutin plasma levels.

#### *Efavirenz*

Efavirenz (400 mg once a day) decreased the  $C_{max}$  and AUC of posaconazole by 45 % and 50 %, respectively. Concomitant use of posaconazole and efavirenz should be avoided unless the benefit to the patient outweighs the risk.

#### *Fosamprenavir*

Combining fosamprenavir with posaconazole may lead to decreased posaconazole plasma concentrations. If concomitant administration is required, close monitoring for breakthrough fungal infections is recommended. Repeat dose administration of fosamprenavir (700 mg twice daily x 10 days) decreased the  $C_{max}$  and AUC of posaconazole oral suspension (200 mg once daily on the 1<sup>st</sup> day, 200 mg twice daily on the 2<sup>nd</sup> day, then 400 mg twice daily x 8 Days) by 21 % and 23 %, respectively. The effect of posaconazole on fosamprenavir levels when fosamprenavir is given with ritonavir is unknown.

#### *Phenytoin*

Phenytoin (200 mg once a day) decreased the  $C_{max}$  and AUC of posaconazole by 41 % and 50 %, respectively. Concomitant use of posaconazole and phenytoin and similar inducers (e.g. carbamazepine, phenobarbital, primidone) should be avoided unless the benefit to the patient outweighs the risk.

### *H<sub>2</sub> receptor antagonists and proton pump inhibitors*

No clinically relevant effects were observed when posaconazole tablets are concomitantly used with antacids, H<sub>2</sub>-receptor antagonists and proton pump inhibitors. No dose adjustment of posaconazole tablets is required when posaconazole tablets are concomitantly used with antacids, H<sub>2</sub>-receptor antagonists and proton pump inhibitors.

### Effects of posaconazole on other medicinal products

Posaconazole is a potent inhibitor of CYP3A4. Co-administration of posaconazole with CYP3A4 substrates may result in large increases in exposure to CYP3A4 substrates as exemplified by the effects on tacrolimus, sirolimus, atazanavir and midazolam below. Caution is advised during co-administration of posaconazole with CYP3A4 substrates administered intravenously and the dose of the CYP3A4 substrate may need to be reduced. If posaconazole is used concomitantly with CYP3A4 substrates that are administered orally, and for which an increase in plasma concentrations may be associated with unacceptable adverse reactions, plasma concentrations of the CYP3A4 substrate and/or adverse reactions should be closely monitored and the dose adjusted as needed. Several of the interaction studies were conducted in healthy volunteers in whom a higher exposure to posaconazole occurs compared to patients administered the same dose. The effect of posaconazole on CYP3A4 substrates in patients might be somewhat lower than that observed in healthy volunteers, and is expected to be variable between patients due to the variable posaconazole exposure in patients. The effect of co-administration with posaconazole on plasma levels of CYP3A4 substrates may also be variable within a patient.

### *Terfenadine, astemizole, cisapride, pimozone, halofantrine and quinidine (CYP3A4 substrates)*

Co-administration of posaconazole and terfenadine, astemizole, cisapride, pimozone, halofantrine or quinidine is contraindicated. Co-administration may result in increased plasma concentrations of these medicinal products, leading to QTc prolongation and rare occurrences of torsades de pointes (see section 4.3).

### *Ergot alkaloids*

Posaconazole may increase the plasma concentration of ergot alkaloids (ergotamine and dihydroergotamine), which may lead to ergotism. Co-administration of posaconazole and ergot alkaloids is contraindicated (see section 4.3).

### *HMG-CoA reductase inhibitors metabolised through CYP3A4 (e.g. simvastatin, lovastatin, and atorvastatin)*

Posaconazole may substantially increase plasma levels of HMG-CoA reductase inhibitors that are metabolised by CYP3A4. Treatment with these HMG-CoA reductase inhibitors should be discontinued during treatment with posaconazole as increased levels have been associated with rhabdomyolysis (see section 4.3).

### *Vinca alkaloids*

Most of the vinca alkaloids (e.g. vincristine and vinblastine) are substrates of CYP3A4. Concomitant administration of azole antifungals, including posaconazole, with vincristine has been associated with serious adverse reactions (see section 4.4). Posaconazole may increase the plasma concentrations of vinca alkaloids which may lead to neurotoxicity and other serious adverse reactions. Therefore, reserve azole antifungals, including posaconazole, for patients receiving a vinca alkaloid, including vincristine, who have no alternative antifungal treatment options.

### *Rifabutin*

Posaconazole increased the C<sub>max</sub> and AUC of rifabutin by 31 % and 72 %, respectively. Concomitant use of posaconazole and rifabutin should be avoided unless the benefit to the patient outweighs the risk (see also above regarding the effect of rifabutin on plasma levels of posaconazole). If these medicinal products are co-administered, careful monitoring of full blood counts and adverse reactions related to increased rifabutin levels (e.g. uveitis) is recommended.

### *Sirolimus*

Repeat dose administration of posaconazole oral suspension (400 mg twice daily for 16 days) increased the  $C_{max}$  and AUC of sirolimus (2 mg single dose) an average of 6.7-fold and 8.9-fold (range 3.1 to 17.5-fold), respectively, in healthy subjects. The effect of posaconazole on sirolimus in patients is unknown, but is expected to be variable due to the variable posaconazole exposure in patients. Co-administration of posaconazole with sirolimus is not recommended and should be avoided whenever possible. If it is considered that co-administration is unavoidable, then it is recommended that the dose of sirolimus should be greatly reduced at the time of initiation of posaconazole therapy and that there should be very frequent monitoring of trough concentrations of sirolimus in whole blood. Sirolimus concentrations should be measured upon initiation, during co-administration, and at discontinuation of posaconazole treatment, with sirolimus doses adjusted accordingly. It should be noted that the relationship between sirolimus trough concentration and AUC is changed during co-administration with posaconazole. As a result, sirolimus trough concentrations that fall within the usual therapeutic range may result in sub-therapeutic levels. Therefore, trough concentrations that fall in the upper part of the usual therapeutic range should be targeted and careful attention should be paid to clinical signs and symptoms, laboratory parameters and tissue biopsies.

### *Ciclosporin*

In heart transplant patients on stable doses of ciclosporin, posaconazole oral suspension 200 mg once daily increased ciclosporin concentrations requiring dose reductions. Cases of elevated ciclosporin levels resulting in serious adverse reactions, including nephrotoxicity and one fatal case of leukoencephalopathy, were reported in clinical efficacy studies. When initiating treatment with posaconazole in patients already receiving ciclosporin, the dose of ciclosporin should be reduced (e.g. to about three quarters of the current dose). Thereafter blood levels of ciclosporin should be monitored carefully during co-administration, and upon discontinuation of posaconazole treatment, and the dose of ciclosporin should be adjusted as necessary.

### *Tacrolimus*

Posaconazole increased  $C_{max}$  and AUC of tacrolimus (0.05 mg/kg body weight single dose) by 121 % and 358 %, respectively. Clinically significant interactions resulting in hospitalisation and/or posaconazole discontinuation were reported in clinical efficacy studies. When initiating posaconazole treatment in patients already receiving tacrolimus, the dose of tacrolimus should be reduced (e.g. to about one third of the current dose). Thereafter blood levels of tacrolimus should be monitored carefully during co-administration, and upon discontinuation of posaconazole, and the dose of tacrolimus should be adjusted as necessary.

### *HIV Protease inhibitors*

As HIV protease inhibitors are CYP3A4 substrates, it is expected that posaconazole will increase plasma levels of these antiretroviral agents. Following co-administration of posaconazole oral suspension (400 mg twice daily) with atazanavir (300 mg once daily) for 7 days in healthy subjects  $C_{max}$  and AUC of atazanavir increased by an average of 2.6-fold and 3.7-fold (range 1.2 to 26-fold), respectively. Following co-administration of posaconazole oral suspension (400 mg twice daily) with atazanavir and ritonavir (300/100 mg once daily) for 7 days in healthy subjects  $C_{max}$  and AUC of atazanavir increased by an average of 1.5-fold and 2.5-fold (range 0.9 to 4.1-fold), respectively. The addition of posaconazole to therapy with atazanavir or with atazanavir plus ritonavir was associated with increases in plasma bilirubin levels. Frequent monitoring for adverse reactions and toxicity related to antiretroviral agents that are substrates of CYP3A4 is recommended during co-administration with posaconazole.

### *Midazolam and other benzodiazepines metabolised by CYP3A4*

In a study in healthy volunteers posaconazole oral suspension (200 mg once daily for 10 days) increased the exposure (AUC) of intravenous midazolam (0.05 mg/kg) by 83 %. In another study in healthy volunteers, repeat dose administration of posaconazole oral suspension (200 mg twice daily for 7 days) increased the  $C_{max}$  and AUC of intravenous midazolam (0.4 mg single dose) by an average of 1.3- and 4.6-fold (range 1.7 to 6.4-fold), respectively; Posaconazole oral suspension 400 mg twice daily for 7 days increased the intravenous midazolam  $C_{max}$  and AUC by 1.6 and 6.2-fold (range 1.6 to 7.6-fold), respectively. Both doses of posaconazole increased  $C_{max}$  and AUC of oral midazolam (2 mg



single oral dose) by 2.2 and 4.5-fold, respectively. In addition, posaconazole oral suspension (200 mg or 400 mg) prolonged the mean terminal half-life of midazolam from approximately 3-4 hours to 8-10 hours during co-administration.

Due to the risk of prolonged sedation it is recommended that dose adjustments should be considered when posaconazole is administered concomitantly with any benzodiazepine that is metabolised by CYP3A4 (e.g. midazolam, triazolam, alprazolam) (see section 4.4).

*Calcium channel blockers metabolised through CYP3A4 (e.g. diltiazem, verapamil, nifedipine, nisoldipine)*

Frequent monitoring for adverse reactions and toxicity related to calcium channel blockers is recommended during co-administration with posaconazole. Dose adjustment of calcium channel blockers may be required.

*Digoxin*

Administration of other azoles has been associated with increases in digoxin levels. Therefore, posaconazole may increase plasma concentration of digoxin and digoxin levels need to be monitored when initiating or discontinuing posaconazole treatment.

*Sulfonylureas*

Glucose concentrations decreased in some healthy volunteers when glipizide was co-administered with posaconazole. Monitoring of glucose concentrations is recommended in diabetic patients.

*All-trans retinoic acid (ATRA) or tretinoin*

As ATRA is metabolised by the hepatic CYP450 enzymes, notably CYP3A4, concomitant administration with posaconazole, which is a strong inhibitor of CYP3A4, may lead to increased exposure to tretinoin resulting in an increased toxicity (especially hypercalcaemia). Serum calcium levels should be monitored and, if needed, appropriate dose adjustments of tretinoin should be considered during the treatment with posaconazole, and during the following days after treatment.

*Venetoclax*

Compared with venetoclax 400 mg administered alone, co-administration of 300 mg posaconazole, a strong CYP3A inhibitor, with venetoclax 50 mg and 100 mg for 7 days in 12 patients, increased venetoclax  $C_{max}$  to 1.6-fold and 1.9-fold, and AUC to 1.9-fold and 2.4-fold, respectively (see sections 4.3 and 4.4).

Refer to the venetoclax SmPC.

Paediatric population

Interaction studies have only been performed in adults.

## **4.6 Fertility, pregnancy and lactation**

Pregnancy

There is insufficient information on the use of posaconazole in pregnant women. Studies in animals have shown reproductive toxicity (see section 5.3). The potential risk for humans is unknown.

Women of childbearing potential have to use effective contraception during treatment. Posaconazole must not be used during pregnancy unless the benefit to the mother clearly outweighs the potential risk to the foetus.

Breast-feeding

Posaconazole is excreted into the milk of lactating rats (see section 5.3). The excretion of posaconazole in human breast milk has not been investigated. Breast-feeding must be stopped on initiation of treatment with posaconazole.

Fertility

Posaconazole had no effect on fertility of male rats at doses up to 180 mg/kg (3.4 times the 300-mg tablet based on steady-state plasma concentrations in patients) or female rats at a dose up to 45 mg/kg

(2.6 times the 300-mg tablet based on steady-state plasma concentrations in patients). There is no clinical experience assessing the impact of posaconazole on fertility in humans.

#### 4.7 Effects on ability to drive and use machines

Since certain adverse reactions (e.g. dizziness, somnolence, etc.) have been reported with posaconazole use, which potentially may affect driving/operating machinery, caution needs to be used.

#### 4.8 Undesirable effects

##### Summary of the safety profile

Safety data mainly derive from studies with the oral suspension.

The safety of posaconazole oral suspension has been assessed in > 2,400 patients and healthy volunteers enrolled in clinical studies and from post-marketing experience. The most frequently reported serious related adverse reactions included nausea, vomiting, diarrhoea, pyrexia, and increased bilirubin.

##### *Posaconazole gastro-resistant powder and solvent for oral suspension and concentrate for solution for infusion safety*

The safety of posaconazole gastro-resistant powder and solvent for oral suspension and concentrate for solution for infusion has been assessed in 115 paediatric patients aged 2 to less than 18 years for prophylaxis use.

The most frequently reported adverse reactions during treatment were alanine aminotransferase increased (2.6 %), aspartate aminotransferase increased (3.5 %) and rash (2.6 %).

##### Tabulated list of adverse reactions

Within the organ system classes, adverse reactions are listed under headings of frequency using the following categories: very common ( $\geq 1/10$ ); common ( $\geq 1/100$  to  $< 1/10$ ); uncommon ( $\geq 1/1,000$  to  $< 1/100$ ); rare ( $\geq 1/10,000$  to  $< 1/1,000$ ); very rare ( $< 1/10,000$ ); not known (cannot be estimated from the available data).

**Table 2.** Adverse reactions by body system and frequency reported in clinical studies and/or post-marketing use\*

<b>Blood and lymphatic system disorders</b>	
Common:	neutropenia
Uncommon:	thrombocytopenia, leukopenia, anaemia, eosinophilia, lymphadenopathy, splenic infarction
Rare:	haemolytic uraemic syndrome, thrombotic thrombocytopenic purpura, pancytopenia, coagulopathy, haemorrhage
<b>Immune system disorders</b>	
Uncommon:	allergic reaction
Rare:	hypersensitivity reaction
<b>Endocrine disorders</b>	
Rare:	adrenal insufficiency, blood gonadotropin decreased, pseudoaldosteronism
<b>Metabolism and nutrition disorders</b>	
Common:	electrolyte imbalance, anorexia, decreased appetite, hypokalaemia, hypomagnesaemia
Uncommon:	hyperglycaemia, hypoglycaemia
<b>Psychiatric disorders</b>	
Uncommon:	abnormal dreams, confusional state, sleep disorder
Rare:	psychotic disorder, depression

<b>Nervous system disorders</b> Common: Uncommon: Rare:	paraesthesia, dizziness, somnolence, headache, dysgeusia convulsions, neuropathy, hypoaesthesia, tremor, aphasia, insomnia cerebrovascular accident, encephalopathy, peripheral neuropathy, syncope
<b>Eye disorders</b> Uncommon: Rare:	blurred vision, photophobia, visual acuity reduced diplopia, scotoma
<b>Ear and labyrinth disorder</b> Rare:	hearing impairment
<b>Cardiac disorders</b> Uncommon: Rare:	long QT syndrome <sup>§</sup> , electrocardiogram abnormal <sup>§</sup> , palpitations, bradycardia, supraventricular extrasystoles, tachycardia torsade de pointes, sudden death, ventricular tachycardia, cardio-respiratory arrest, cardiac failure, myocardial infarction
<b>Vascular disorders</b> Common: Uncommon: Rare:	hypertension hypotension, vasculitis pulmonary embolism, deep vein thrombosis
<b>Respiratory, thoracic and mediastinal disorders</b> Uncommon: Rare:	cough, epistaxis, hiccups, nasal congestion, pleuritic pain, tachypnoea pulmonary hypertension, interstitial pneumonia, pneumonitis
<b>Gastrointestinal disorders</b> Very Common: Common: Uncommon: Rare:	nausea vomiting, abdominal pain, diarrhoea, dyspepsia, dry mouth, flatulence, constipation, anorectal discomfort pancreatitis, abdominal distension, enteritis, epigastric discomfort, eructation, gastroesophageal reflux disease, oedema mouth gastrointestinal haemorrhage, ileus
<b>Hepatobiliary disorders</b> Common: Uncommon: Rare:	liver function tests raised (ALT increased, AST increased, bilirubin increased, alkaline phosphatase increased, GGT increased) hepatocellular damage, hepatitis, jaundice, hepatomegaly, cholestasis, hepatic toxicity, hepatic function abnormal hepatic failure, hepatitis cholestatic, hepatosplenomegaly, liver tenderness, asterixis
<b>Skin and subcutaneous tissue disorders</b> Common: Uncommon: Rare:	rash, pruritis mouth ulceration, alopecia, dermatitis, erythema, petechiae Stevens Johnson syndrome, vesicular rash
<b>Musculoskeletal and connective tissue disorders</b> Uncommon:	back pain, neck pain, musculoskeletal pain, pain in extremity
<b>Renal and urinary disorders</b> Uncommon: Rare:	acute renal failure, renal failure, blood creatinine increased renal tubular acidosis, interstitial nephritis

<b>Reproductive system and breast disorders</b>	
Uncommon:	menstrual disorder
Rare:	breast pain
<b>General disorders and administration site conditions</b>	
Common:	pyrexia (fever), asthenia, fatigue
Uncommon:	oedema, pain, chills, malaise, chest discomfort, drug intolerance, feeling jittery, mucosal inflammation
Rare:	tongue oedema, face oedema
<b>Investigations</b>	
Uncommon:	altered medicine levels, blood phosphorus decreased, chest x-ray abnormal

\* Based on adverse reactions observed with the oral suspension, gastro-resistant tablets, concentrate for solution for infusion, and gastro-resistant powder and solvent for oral suspension.

§ See section 4.4.

#### Description of selected adverse reactions

##### *Hepatobiliary disorders*

During post-marketing surveillance of posaconazole oral suspension, severe hepatic injury with fatal outcome has been reported (see section 4.4).

#### Reporting of suspected adverse reactions

Reporting suspected adverse reactions after authorisation of the medicinal product is important. It allows continued monitoring of the benefit/risk balance of the medicinal product. Healthcare professionals are asked to report any suspected adverse reactions via **the national reporting system** listed in [Appendix V](#).

## 4.9 Overdose

There is no experience with overdose of posaconazole gastro-resistant powder and solvent for oral suspension.

During clinical studies, patients who received posaconazole oral suspension doses up to 1,600 mg/day experienced no different adverse reactions from those reported with patients at the lower doses. Accidental overdose was noted in one patient who took posaconazole oral suspension 1,200 mg twice a day for 3 days. No adverse reactions were noted by the investigator.

Posaconazole is not removed by haemodialysis. There is no special treatment available in the case of overdose with posaconazole. Supportive care may be considered.

## 5. PHARMACOLOGICAL PROPERTIES

### 5.1 Pharmacodynamic properties

Pharmacotherapeutic group: Antimycotics for systemic use, triazole derivatives, ATC code: J02AC04.

#### Mechanism of action

Posaconazole inhibits the enzyme lanosterol 14 $\alpha$ -demethylase (CYP51), which catalyses an essential step in ergosterol biosynthesis.

#### Microbiology

Posaconazole has been shown *in vitro* to be active against the following microorganisms: *Aspergillus* species (*Aspergillus fumigatus*, *A. flavus*, *A. terreus*, *A. nidulans*, *A. niger*, *A. ustus*), *Candida* species (*Candida albicans*, *C. glabrata*, *C. krusei*, *C. parapsilosis*, *C. tropicalis*, *C. dubliniensis*, *C. famata*, *C. inconspicua*, *C. lipolytica*, *C. norvegensis*, *C. pseudotropicalis*), *Coccidioides immitis*, *Fonsecaea*

*pedrosoi*, and species of *Fusarium*, *Rhizomucor*, *Mucor*, and *Rhizopus*. The microbiological data suggest that posaconazole is active against *Rhizomucor*, *Mucor*, and *Rhizopus*; however, the clinical data are currently too limited to assess the efficacy of posaconazole against these causative agents.

The following *in vitro* data are available, but their clinical significance is unknown. In a surveillance study of > 3,000 clinical mold isolates from 2010-2018, 90 % of non-*Aspergillus* fungi exhibited the following *in vitro* minimum inhibitory concentration (MIC): *Mucorales* spp (n=81) of 2 mg/L; *Scedosporium apiospermum*/*S. boydii* (n=65) of 2 mg/L; *Exophiala dermatitidis* (n=15) of 0.5 mg/L, and *Purpureocillium lilacinum* (n=21) of 1 mg/L.

### Resistance

Clinical isolates with decreased susceptibility to posaconazole have been identified. The principle mechanism of resistance is the acquisition of substitutions in the target protein, CYP51.

### Epidemiological Cut-off (ECOFF) Values for *Aspergillus* spp.

The ECOFF values for posaconazole, which distinguish the wild type population from isolates with acquired resistance, have been determined by EUCAST methodology.

EUCAST ECOFF values:

- *Aspergillus flavus*: 0.5 mg/L
- *Aspergillus fumigatus*: 0.5 mg/L
- *Aspergillus nidulans*: 0.5 mg/L
- *Aspergillus niger*: 0.5 mg/L
- *Aspergillus terreus*: 0.25 mg/L

There are currently insufficient data to set clinical breakpoints for *Aspergillus* spp. ECOFF values do not equate to clinical breakpoints.

### Breakpoints

EUCAST MIC breakpoints for posaconazole [susceptible (S); resistant (R)]:

- *Candida albicans*: S ≤0.06 mg/L, R >0.06 mg/L
- *Candida tropicalis*: S ≤0.06 mg/L, R >0.06 mg/L
- *Candida parapsilosis*: S ≤0.06 mg/L, R >0.06 mg/L
- *Candida dubliniensis*: S ≤0.06 mg/L, R > 0.06 mg/L

There are currently insufficient data to set clinical breakpoints for other *Candida* species.

### Combination with other antifungal agents

The use of combination antifungal therapies should not decrease the efficacy of either posaconazole or the other therapies; however, there is currently no clinical evidence that combination therapy will provide an added benefit.

### Clinical experience

#### Summary of gastro-resistant powder and solvent for oral suspension and concentrate for solution for infusion bridging study

The pharmacokinetics and safety of posaconazole concentrate for solution for infusion and gastro-resistant powder and solvent for oral suspension have been assessed in 115 paediatric subjects aged 2 to less than 18 years in a nonrandomized, multi-center, open-label, sequential dose-escalation study (Study 097). Immunocompromised paediatric subjects with known or expected neutropenia were exposed to posaconazole at 3.5 mg/kg, 4.5 mg/kg or 6.0 mg/kg daily (BID on Day 1). All 115 subjects initially received posaconazole concentrate for solution for infusion for at least 7 days, and 63 subjects were transitioned to gastro-resistant powder and solvent for oral suspension. The mean overall treatment duration (posaconazole concentrate for solution for infusion and gastro-resistant powder and solvent for oral suspension) of all treated subjects was 20.6 days (see section 5.2).

### Paediatric population

The safety and efficacy of posaconazole have been established in paediatric patients 2 to less than 18 years of age. Use of posaconazole in these age groups is supported by evidence from adequate and well-controlled studies of posaconazole in adults, pharmacokinetic and safety data from paediatric studies, and by population pharmacokinetic modelling (see section 5.2). No new safety signals associated with the use of posaconazole in paediatric patients were identified in the paediatric studies (see section 4.8).

Safety and efficacy of Noxafil have not been established in paediatric patients below the age of 2 years.

No data are available.

### Electrocardiogram evaluation

Multiple, time-matched ECGs collected over a 12-hour period were obtained before and during administration of posaconazole oral suspension (400 mg twice daily with high fat meals) from 173 healthy male and female volunteers aged 18 to 85 years. No clinically relevant changes in the mean QTc (Fridericia) interval from baseline were observed.

## **5.2 Pharmacokinetic properties**

### Absorption

The absolute bioavailability of the gastro-resistant powder and solvent for oral suspension is approximately 83 %. Administration of posaconazole gastro-resistant powder and solvent for oral suspension following consumption of a high fat meal in adults had no significant effect on AUC and resulted in a moderate (23% to 41 %) decrease in  $C_{max}$ . Based on a population pharmacokinetic model, no significant effect of a meal on posaconazole gastro-resistant powder and solvent for oral suspension bioavailability was identified in paediatric patients 2 to less than 18 years of age. Therefore, the gastro-resistant powder and solvent for oral suspension can be administered without regard to food.

Concomitant administration of posaconazole gastro-resistant powder and solvent for oral suspension with medicinal products affecting gastric pH or gastric motility would not be expected to demonstrate any significant effects on posaconazole pharmacokinetic exposure based on similarity to the gastro-resistant tablets.

An *in vitro* dissolution study was conducted to evaluate the impact of alcohol (5, 10, 20, and 40 %) on the dissolution of Noxafil gastro-resistant powder and solvent for oral suspension. Posaconazole was found to release faster from Noxafil gastro-resistant powder and solvent for oral suspension in the presence of alcohol *in vitro*, which may interfere with its delayed release characteristics.

### Distribution

Posaconazole has a central volume of distribution of 112 L (5.2 % RSE) based on population PK modelling in paediatric subjects receiving IV or PFS formulations. Posaconazole is highly protein bound (> 98 %), predominantly to serum albumin.

### Biotransformation

Posaconazole does not have any major circulating metabolites and its concentrations are unlikely to be altered by inhibitors of CYP450 enzymes. Of the circulating metabolites, the majority are glucuronide conjugates of posaconazole with only minor amounts of oxidative (CYP450 mediated) metabolites observed. The excreted metabolites in urine and faeces account for approximately 17 % of the administered radiolabelled dose.

### Elimination

Posaconazole is slowly eliminated with a mean clearance 4.7 L/h (3.9%RSE) and a corresponding to half-life ( $t_{1/2}$ ) of 24 hours based on population PK modelling in paediatric subjects receiving IV or PFS. After administration of  $^{14}C$ -posaconazole, radioactivity was predominantly recovered in the faeces (77 % of the radiolabelled dose) with the major component being parent compound (66 % of the

radiolabelled dose). Renal clearance is a minor elimination pathway, with 14 % of the radiolabelled dose excreted in urine (< 0.2 % of the radiolabelled dose is parent compound). Steady-state plasma concentrations are attained by Day 7 after once daily dosing (twice daily on Day 1) in paediatric subject receiving PFS.

### Pharmacokinetics in special populations

#### *Children (< 18 years)*

Based on a population pharmacokinetic model evaluating posaconazole pharmacokinetics and predicting exposures in paediatric patients, the exposure target of steady-state posaconazole average concentration ( $C_{av}$ ) of approximately 1,200 ng/mL and  $C_{av} \geq 500$  ng/mL in approximately 90 % of patients is attained with the recommended dose of posaconazole concentrate for solution for infusion and gastro-resistant powder and solvent for oral suspension. Simulations, using the population pharmacokinetic model, predict a  $C_{av} \geq 500$  ng/mL in 90% of paediatric patients weighing at least 40 kg following administration of the adult dose of posaconazole gastro-resistant tablets (300 mg twice daily on Day 1 and 300 mg once daily starting on Day 2).

The population pharmacokinetic analysis of posaconazole in paediatric patients suggests that age, sex, renal impairment and ethnicity have no clinically meaningful effect on the pharmacokinetics of posaconazole.

No dose adjustment is recommended in case of renal impairment (see section 4.2).

### **5.3 Preclinical safety data**

As observed with other azole antifungal agents, effects related to inhibition of steroid hormone synthesis were seen in repeated-dose toxicity studies with posaconazole. Adrenal suppressive effects were observed in toxicity studies in rats and dogs at exposures equal to or greater than those obtained at therapeutic doses in humans.

Neuronal phospholipidosis occurred in dogs dosed for  $\geq 3$  months at lower systemic exposures than those obtained at therapeutic doses in humans. This finding was not seen in monkeys dosed for one year. In twelve-month neurotoxicity studies in dogs and monkeys, no functional effects were observed on the central or peripheral nervous systems at systemic exposures greater than those achieved therapeutically.

Pulmonary phospholipidosis resulting in dilatation and obstruction of the alveoli was observed in the 2-year study in rats. These findings are not necessarily indicative of a potential for functional changes in humans.

In a nonclinical study using intravenous administration of posaconazole in very young dogs (dosed from 2-8 weeks of age) an increase in the incidence of brain ventricle enlargement was observed in treated animals as compared with concurrent control animals. No difference in the incidence of brain ventricle enlargement between control and treated animals was observed following the subsequent 5 month treatment-free period. There were no neurologic, behavioural or developmental abnormalities in the dogs with this finding, and a similar brain finding was not seen with either oral posaconazole administration to juvenile dogs (4 days to 9 months of age) or intravenous posaconazole administration to juvenile dogs (10 weeks to 23 weeks of age). The clinical significance of this finding is unknown.

No effects on electrocardiograms, including QT and QTc intervals, were seen in a repeat dose safety pharmacology study in monkeys at maximal plasma concentrations 8.5-fold greater than the concentrations obtained at therapeutic doses in humans. Echocardiography revealed no indication of cardiac decompensation in a repeat dose safety pharmacology study in rats at a systemic exposure 2.1-fold greater than that achieved therapeutically. Increased systolic and arterial blood pressures (up to 29 mm-Hg) were seen in rats and monkeys at systemic exposures 2.1-fold and 8.5-fold greater, respectively, than those achieved with the human therapeutic doses.

Reproduction, peri- and postnatal development studies were conducted in rats. At exposures lower than those obtained at therapeutic doses in humans, posaconazole caused skeletal variations and malformations, dystocia, increased length of gestation, reduced mean litter size and postnatal viability. In rabbits, posaconazole was embryotoxic at exposures greater than those obtained at therapeutic doses. As observed with other azole antifungal agents, these effects on reproduction were considered to be due to a treatment-related effect on steroidogenesis.

Posaconazole was not genotoxic in *in vitro* and *in vivo* studies. Carcinogenicity studies did not reveal special hazards for humans.

## **6. PHARMACEUTICAL PARTICULARS**

### **6.1 List of excipients**

#### *Powder*

Hypromellose acetate succinate

#### *Solvent*

purified water

glycerol (E422)

methyl parahydroxybenzoate (E218)

propyl parahydroxybenzoate

sodium dihydrogen phosphate monohydrate

citric acid anhydrous (E330)

xanthan gum (E415)

sodium citrate (E331)

saccharin sodium (E954)

microcrystalline cellulose

carmellose sodium

carrageenan calcium sulfate trisodium phosphate (E407)

sorbitol solution (E420)

potassium sorbate (E202)

flavour berry citrus sweet containing propylene glycol (E1520), water, natural and artificial flavour

antifoam Af emulsion containing polyethylene glycol (E1521), octamethyl cyclotetrasiloxane, decamethylcyclopentasiloxane and poly(oxy-1,2-ethanediyl), .alpha.-(1-oxooctadecyl)-.omega.-hydroxy

### **6.2 Incompatibilities**

Not applicable.

### **6.3 Shelf life**

2 years

After reconstitution: 30 minutes.

### **6.4 Special precautions for storage**

This medicinal product does not require any special storage conditions.

For storage conditions after reconstitution of the medicinal product, see section 6.3.



## 6.5 Nature and contents of container

Noxafil gastro-resistant powder and solvent for oral suspension is supplied as a pack containing:

Package 1: The kit contains 8 child-resistant single-use sachets (PET/aluminium/LLDPE), two 3 mL (green) notched tip syringes, two 10 mL (blue) notched tip syringes, two mixing cups, one 473 mL solvent bottle (HDPE) with polypropylene (PP) closure with a foil induction seal liner, and one bottle adapter for the solvent bottle.

Package 2: A box of six 3 mL (green) and six 10 mL (blue) notched tip syringes.

## 6.6 Special precautions for disposal and other handling

Complete details on preparation and administration of the gastro-resistant powder and solvent for oral suspension can be found in the instructions for use booklet that is included in the kit. Parents and/or caregivers should be instructed to read the instructions for use booklet before preparing and administering Noxafil gastro-resistant powder and solvent for oral suspension.

Each single-use sachet contains 300 mg of posaconazole which is suspended in 9 mL of solvent to obtain 10 mL total of suspension with a final concentration of approximately 30 mg per mL.

Note: ONLY the solvent in the kit should be used to prepare Noxafil.

Note: To ensure delivery of the correct dose, ONLY the provided notched tip syringes should be used for preparation and administration. The design of the notched tip syringe prevents aggregation of the suspension during preparation and administration.

The notch-tip syringe provided in the kit should be used to administer Noxafil with the enteral feeding tube. The enteral feeding tube size should be selected based on the patient characteristics. Use a suitable enteral feeding tube based on tube material per the following table.

<b>Type</b>	<b>Tube material</b>	<b>Tube size</b>
Gastric Tubing	Polyurethane	16 Fr or larger
	Silicone	14 Fr or larger
Nasogastric Tubing	PVC*	12 Fr or larger
	Polyurethane	12 Fr or larger

\*PVC – polyvinyl chloride

The tube should be flushed again with at least 10 mL water to ensure Noxafil is delivered and to clear the tube.

After administration of the required volume, the remaining suspension in the mixing cup cannot be re-used and must be discarded.

The dose should be administered orally within 30 minutes of mixing.

Any unused medicinal product, solvent or waste material should be disposed of in accordance with local requirements.

## 7. MARKETING AUTHORISATION HOLDER

Merck Sharp & Dohme B.V.  
Waarderweg 39  
2031 BN Haarlem  
The Netherlands

**8.     MARKETING AUTHORISATION NUMBER(S)**

EU/1/05/320/005

**9.     DATE OF FIRST AUTHORISATION/RENEWAL OF THE AUTHORISATION**

Date of first authorisation: 25 October 2005

Date of latest renewal: 25 October 2010

**10.    DATE OF REVISION OF THE TEXT**

<{MM/YYYY}>

Detailed information on this medicinal product is available on the website of the European Medicines Agency <http://www.ema.europa.eu>.

## **ANNEX II**

- A. MANUFACTURERS RESPONSIBLE FOR BATCH RELEASE**
- B. CONDITIONS OR RESTRICTIONS REGARDING SUPPLY AND USE**
- C. OTHER CONDITIONS AND REQUIREMENTS OF THE MARKETING AUTHORISATION**
- D. CONDITIONS OR RESTRICTIONS WITH REGARD TO THE SAFE AND EFFECTIVE USE OF THE MEDICINAL PRODUCT**

## **A MANUFACTURERS RESPONSIBLE FOR BATCH RELEASE**

Name and address of the manufacturer (s) responsible for batch release

Organon Heist bv, Industriepark 30, 2220 Heist-op-den-Berg, Belgium

Merck Sharp & Dohme B. V. Waarderweg 39, 2031 BN, Haarlem, The Netherlands

The printed package leaflet of the medicinal product must state the name and address of the manufacturer responsible for the release of the concerned batch.

## **B CONDITIONS OR RESTRICTIONS REGARDING SUPPLY AND USE**

Medicinal product subject to restricted medical prescription. (see Annex I: Summary of Product Characteristics, section 4.2).

## **C OTHER CONDITIONS AND REQUIREMENTS OF THE MARKETING AUTHORISATION**

- **Periodic safety update reports (PSURs)**

The requirements for submission of PSURs for this medicinal product are set out in the list of Union reference dates (EURD list) provided for under Article 107c(7) of Directive 2001/83/EC and any subsequent updates published on the European medicines web-portal.

## **D. CONDITIONS OR RESTRICTIONS WITH REGARD TO THE SAFE AND EFFECTIVE USE OF THE MEDICINAL PRODUCT**

- **Risk management plan (RMP)**

The marketing authorisation holder (MAH) shall perform the required pharmacovigilance activities and interventions detailed in the agreed RMP presented in Module 1.8.2 of the marketing authorisation and any agreed subsequent updates of the RMP.

An updated RMP should be submitted:

- At the request of the European Medicines Agency;
- Whenever the risk management system is modified, especially as the result of new information being received that may lead to a significant change to the benefit/risk profile or as the result of an important (pharmacovigilance or risk minimisation) milestone being reached.

**ANNEX III**  
**LABELLING AND PACKAGE LEAFLET**

## **A. LABELLING**

**PARTICULARS TO APPEAR ON THE OUTER PACKAGING**

**OUTER CARTON**

**1. NAME OF THE MEDICINAL PRODUCT**

Noxafil 40 mg/mL oral suspension  
posaconazole

**2. STATEMENT OF ACTIVE SUBSTANCE(S)**

Each mL of oral suspension contains 40 mg of posaconazole.

**3. LIST OF EXCIPIENTS**

Contains also liquid glucose, sodium benzoate (E211), benzyl alcohol, propylene glycol (E1520).  
See leaflet for further information.

**4. PHARMACEUTICAL FORM AND CONTENTS**

One bottle of 105 mL of oral suspension.  
Measuring spoon

**5. METHOD AND ROUTE(S) OF ADMINISTRATION**

Shake well before use.  
Read the package leaflet before use.  
Oral use

**6. SPECIAL WARNING THAT THE MEDICINAL PRODUCT MUST BE STORED OUT OF THE SIGHT AND REACH OF CHILDREN**

Keep out of the sight and reach of children.

**7. OTHER SPECIAL WARNING(S), IF NECESSARY**

**Noxafil oral suspension and tablets are NOT interchangeable.**

**8. EXPIRY DATE**

EXP  
Any product remaining four weeks after opening the bottle should be discarded. Open date: \_\_\_\_\_

**9. SPECIAL STORAGE CONDITIONS**

Do not freeze.

**10. SPECIAL PRECAUTIONS FOR DISPOSAL OF UNUSED MEDICINAL PRODUCTS OR WASTE MATERIALS DERIVED FROM SUCH MEDICINAL PRODUCTS, IF APPROPRIATE**

**11. NAME AND ADDRESS OF THE MARKETING AUTHORISATION HOLDER**

Merck Sharp & Dohme B.V.  
Waarderweg 39  
2031 BN Haarlem  
The Netherlands

**12. MARKETING AUTHORISATION NUMBER(S)**

EU/1/05/320/001

**13. BATCH NUMBER**

Lot

**14. GENERAL CLASSIFICATION FOR SUPPLY**

**15. INSTRUCTIONS ON USE**

**16. INFORMATION IN BRAILLE**

Noxafil oral suspension

**17. UNIQUE IDENTIFIER – 2D BARCODE**

2D barcode carrying the unique identifier included.

**18. UNIQUE IDENTIFIER – HUMAN READABLE DATA**

PC  
SN  
NN



**PARTICULARS TO APPEAR ON THE IMMEDIATE PACKAGING**

**BOTTLE LABEL**

**1. NAME OF THE MEDICINAL PRODUCT**

Noxafil 40 mg/mL oral suspension  
posaconazole

**2. STATEMENT OF ACTIVE SUBSTANCE(S)**

Each mL of suspension contains 40 mg of posaconazole.

**3. LIST OF EXCIPIENTS**

Contains also liquid glucose, sodium benzoate (E211), benzyl alcohol, propylene glycol (E1520).  
See leaflet for further information.

**4. PHARMACEUTICAL FORM AND CONTENTS**

105 mL  
oral suspension

**5. METHOD AND ROUTE(S) OF ADMINISTRATION**

**Shake well before use.**  
Read the package leaflet before use.  
Oral use

**6. SPECIAL WARNING THAT THE MEDICINAL PRODUCT MUST BE STORED OUT OF THE SIGHT AND REACH OF CHILDREN**

Keep out of the sight and reach of children.

**7. OTHER SPECIAL WARNING(S), IF NECESSARY**

**8. EXPIRY DATE**

EXP  
Discard after 4 weeks. Open date: \_\_\_\_\_

**9. SPECIAL STORAGE CONDITIONS**

Do not freeze.

**10. SPECIAL PRECAUTIONS FOR DISPOSAL OF UNUSED MEDICINAL PRODUCTS OR WASTE MATERIALS DERIVED FROM SUCH MEDICINAL PRODUCTS, IF APPROPRIATE**

**11. NAME AND ADDRESS OF THE MARKETING AUTHORISATION HOLDER**

Merck Sharp & Dohme B.V.

**12. MARKETING AUTHORISATION NUMBER(S)**

EU/1/05/320/001

**13. BATCH NUMBER**

Lot

**14. GENERAL CLASSIFICATION FOR SUPPLY**

**15. INSTRUCTIONS ON USE**

**16. INFORMATION IN BRAILLE**

**17. UNIQUE IDENTIFIER – 2D BARCODE**

**18. UNIQUE IDENTIFIER – HUMAN READABLE DATA**

**PARTICULARS TO APPEAR ON THE OUTER PACKAGING**

**OUTER CARTON**

**1. NAME OF THE MEDICINAL PRODUCT**

Noxafil 100 mg gastro-resistant tablets  
posaconazole

**2. STATEMENT OF ACTIVE SUBSTANCE(S)**

Each gastro-resistant tablet contains 100 mg of posaconazole.

**3. LIST OF EXCIPIENTS**

**4. PHARMACEUTICAL FORM AND CONTENTS**

24 gastro-resistant tablets  
96 gastro-resistant tablets

**5. METHOD AND ROUTE(S) OF ADMINISTRATION**

Read the package leaflet before use.  
Oral use

**6. SPECIAL WARNING THAT THE MEDICINAL PRODUCT MUST BE STORED OUT OF THE SIGHT AND REACH OF CHILDREN**

Keep out of the sight and reach of children.

**7. OTHER SPECIAL WARNING(S), IF NECESSARY**

Noxafil oral suspension and tablets are NOT interchangeable.

**8. EXPIRY DATE**

EXP

**9. SPECIAL STORAGE CONDITIONS**

**10. SPECIAL PRECAUTIONS FOR DISPOSAL OF UNUSED MEDICINAL PRODUCTS OR WASTE MATERIALS DERIVED FROM SUCH MEDICINAL PRODUCTS, IF APPROPRIATE**

**11. NAME AND ADDRESS OF THE MARKETING AUTHORISATION HOLDER**

Merck Sharp & Dohme B.V.  
Waarderweg 39  
2031 BN Haarlem  
The Netherlands

**12. MARKETING AUTHORISATION NUMBER(S)**

EU/1/05/320/002 24 tablets  
EU/1/05/320/003 96 tablets

**13. BATCH NUMBER**

Lot

**14. GENERAL CLASSIFICATION FOR SUPPLY**

**15. INSTRUCTIONS ON USE**

**16. INFORMATION IN BRAILLE**

noxafil tablets

**17. UNIQUE IDENTIFIER – 2D BARCODE**

2D barcode carrying the unique identifier included.

**18. UNIQUE IDENTIFIER – HUMAN READABLE DATA**

PC  
SN  
NN

**MINIMUM PARTICULARS TO APPEAR ON BLISTERS OR STRIPS**

**BLISTERS**

**1. NAME OF THE MEDICINAL PRODUCT**

Noxafil 100 mg gastro-resistant tablets  
posaconazole

**2. NAME OF THE MARKETING AUTHORISATION HOLDER**

MSD

**3. EXPIRY DATE**

EXP

**4. BATCH NUMBER**

Lot

**5. OTHER**

**PARTICULARS TO APPEAR ON THE OUTER PACKAGING**

**OUTER CARTON**

**1. NAME OF THE MEDICINAL PRODUCT**

Noxafil 300 mg concentrate for solution for infusion  
posaconazole

**2. STATEMENT OF ACTIVE SUBSTANCE(S)**

Each vial contains 300 mg of posaconazole.  
Each mL contains 18 mg of posaconazole.

**3. LIST OF EXCIPIENTS**

Excipients: Betadex Sulfobutyl Ether Sodium (SBECD), disodium edetate, hydrochloric acid and sodium hydroxide (for pH adjustment), water for injections.  
See leaflet for further information.

**4. PHARMACEUTICAL FORM AND CONTENTS**

Concentrate for solution for infusion  
1 vial

**5. METHOD AND ROUTE(S) OF ADMINISTRATION**

Read the package leaflet before use.  
Intravenous use after dilution.  
Single use vial.

**6. SPECIAL WARNING THAT THE MEDICINAL PRODUCT MUST BE STORED OUT OF THE SIGHT AND REACH OF CHILDREN**

Keep out of the sight and reach of children.

**7. OTHER SPECIAL WARNING(S), IF NECESSARY**

**8. EXPIRY DATE**

EXP

**9. SPECIAL STORAGE CONDITIONS**

**Store in a refrigerator.**

**10. SPECIAL PRECAUTIONS FOR DISPOSAL OF UNUSED MEDICINAL PRODUCTS OR WASTE MATERIALS DERIVED FROM SUCH MEDICINAL PRODUCTS, IF APPROPRIATE**

**11. NAME AND ADDRESS OF THE MARKETING AUTHORISATION HOLDER**

Merck Sharp & Dohme B.V.  
Waarderweg 39  
2031 BN Haarlem  
The Netherlands

**12. MARKETING AUTHORISATION NUMBER(S)**

EU/1/05/320/004      1 vial

**13. BATCH NUMBER**

Lot

**14. GENERAL CLASSIFICATION FOR SUPPLY**

**15. INSTRUCTIONS ON USE**

**16. INFORMATION IN BRAILLE**

Justification for not including Braille accepted

**17. UNIQUE IDENTIFIER – 2D BARCODE**

2D barcode carrying the unique identifier included.

**18. UNIQUE IDENTIFIER – HUMAN READABLE DATA**

PC  
SN  
NN

**MINIMUM PARTICULARS TO APPEAR ON SMALL IMMEDIATE PACKAGING UNITS**

**VIAL LABEL**

**1. NAME OF THE MEDICINAL PRODUCT AND ROUTE(S) OF ADMINISTRATION**

Noxafil 300 mg sterile concentrate  
posaconazole  
Intravenous use after dilution

**2. METHOD OF ADMINISTRATION**

See leaflet

**3. EXPIRY DATE**

EXP

**4. BATCH NUMBER**

Lot

**5. CONTENTS BY WEIGHT, BY VOLUME OR BY UNIT**

**6. OTHER**



**PARTICULARS TO APPEAR ON THE OUTER PACKAGING**

**OUTER CARTON (WITH BLUE BOX)**

**1. NAME OF THE MEDICINAL PRODUCT**

Noxafil 300 mg gastro-resistant powder and solvent for oral suspension  
posaconazole

**2. STATEMENT OF ACTIVE SUBSTANCE(S)**

Each sachet contains 300 mg of posaconazole. Following reconstitution, the gastro-resistant oral suspension has a concentration of approximately 30 mg per mL.

**3. LIST OF EXCIPIENTS**

The reconstituted product contains methyl parahydroxybenzoate (E218), propyl parahydroxybenzoate, propylene glycol (E1520) and sorbitol solution (E420). See leaflet for further information.

**4. PHARMACEUTICAL FORM AND CONTENTS**

Gastro-resistant powder and solvent for oral suspension

This box contains a pack (pack 1) with: 8 sachets, two 3 mL and two 10 mL notched tip syringes, two mixing cups, one solvent bottle and one bottle adapter; and a pack (pack 2) with: extra six 3 mL and six 10 mL notched tip syringes.

**5. METHOD AND ROUTE(S) OF ADMINISTRATION**

Read the package leaflet before use.  
Oral use

**6. SPECIAL WARNING THAT THE MEDICINAL PRODUCT MUST BE STORED OUT OF THE SIGHT AND REACH OF CHILDREN**

Keep out of the sight and reach of children.

**7. OTHER SPECIAL WARNING(S), IF NECESSARY**

Noxafil gastro-resistant powder and solvent for oral suspension is NOT interchangeable with Noxafil oral suspension.

**8. EXPIRY DATE**

EXP

**9. SPECIAL STORAGE CONDITIONS**

After reconstitution: the gastro-resistant oral suspension must be used within 30 minutes.

**10. SPECIAL PRECAUTIONS FOR DISPOSAL OF UNUSED MEDICINAL PRODUCTS OR WASTE MATERIALS DERIVED FROM SUCH MEDICINAL PRODUCTS, IF APPROPRIATE**

**11. NAME AND ADDRESS OF THE MARKETING AUTHORISATION HOLDER**

Merck Sharp & Dohme B.V.  
Waarderweg 39  
2031 BN Haarlem  
The Netherlands

**12. MARKETING AUTHORISATION NUMBER(S)**

EU/1/05/320/005

**13. BATCH NUMBER**

Lot

**14. GENERAL CLASSIFICATION FOR SUPPLY**

**15. INSTRUCTIONS ON USE**

**16. INFORMATION IN BRAILLE**

noxafil 300 mg powder for oral suspension

**17. UNIQUE IDENTIFIER – 2D BARCODE**

2D barcode carrying the unique identifier included.

**18. UNIQUE IDENTIFIER - HUMAN READABLE DATA**

PC  
SN  
NN

**PARTICULARS TO APPEAR ON THE OUTER PACKAGING**

**INNER CARTON – Pack 1 (of 2) (WITHOUT BLUE BOX)**

**NOXAFIL 300 mg gastro-resistant powder and solvent for oral suspension**

**1. NAME OF THE MEDICINAL PRODUCT**

Noxafil 300 mg gastro-resistant powder and solvent for oral suspension  
posaconazole

**Pack 1 (of 2)**

**2. STATEMENT OF ACTIVE SUBSTANCE(S)**

Each sachet contains 300 mg of posaconazole. Following reconstitution, the gastro-resistant oral suspension has a concentration of approximately 30 mg per mL.

**3. LIST OF EXCIPIENTS**

The reconstituted product contains methyl parahydroxybenzoate (E218), propyl parahydroxybenzoate, propylene glycol (E1520) and sorbitol solution (E420). See leaflet for further information.

**4. PHARMACEUTICAL FORM AND CONTENTS**

Gastro-resistant powder and solvent for oral suspension

This pack contains: 8 sachets, two 3 mL and two 10 mL notched tip syringes, two mixing cups, one solvent bottle and one bottle adapter.

**5. METHOD AND ROUTE(S) OF ADMINISTRATION**

Read the package leaflet and booklet before use.  
Oral use

**6. SPECIAL WARNING THAT THE MEDICINAL PRODUCT MUST BE STORED OUT OF THE SIGHT AND REACH OF CHILDREN**

Keep out of the sight and reach of children.

**7. OTHER SPECIAL WARNING(S), IF NECESSARY**

Noxafil gastro-resistant powder and solvent for oral suspension is NOT interchangeable with Noxafil oral suspension.

**8. EXPIRY DATE**

EXP

**9. SPECIAL STORAGE CONDITIONS**

After reconstitution: the gastro-resistant oral suspension must be used within 30 minutes.

**10. SPECIAL PRECAUTIONS FOR DISPOSAL OF UNUSED MEDICINAL PRODUCTS OR WASTE MATERIALS DERIVED FROM SUCH MEDICINAL PRODUCTS, IF APPROPRIATE****11. NAME AND ADDRESS OF THE MARKETING AUTHORISATION HOLDER**

Merck Sharp & Dohme B.V.  
Waarderweg 39  
2031 BN Haarlem  
The Netherlands

**12. MARKETING AUTHORISATION NUMBER(S)**

EU/1/05/320/005

**13. BATCH NUMBER**

Lot

**14. GENERAL CLASSIFICATION FOR SUPPLY****15. INSTRUCTIONS ON USE****16. INFORMATION IN BRAILLE**

noxafil 300 mg powder for oral suspension

**17. UNIQUE IDENTIFIER – 2D BARCODE****18. UNIQUE IDENTIFIER – HUMAN READABLE DATA**

**MINIMUM PARTICULARS TO APPEAR ON SMALL IMMEDIATE PACKAGING UNITS**

**SACHET LABEL for NOXAFIL 300 mg gastro-resistant powder for oral suspension**

**1. NAME OF THE MEDICINAL PRODUCT AND ROUTE(S) OF ADMINISTRATION**

Noxafil 300 mg gastro-resistant powder for oral suspension  
posaconazole

oral use

**2. METHOD OF ADMINISTRATION**

Read the package leaflet and booklet before use.

**3. EXPIRY DATE**

EXP

**4. BATCH NUMBER**

Lot

**5. CONTENTS BY WEIGHT, BY VOLUME OR BY UNIT**

**6. OTHER**

MSD

**PARTICULARS TO APPEAR ON THE IMMEDIATE PACKAGING**

**LABEL for the SOLVENT bottle to be used with Noxafil 300 mg gastro-resistant powder for oral suspension**

**1. NAME OF THE MEDICINAL PRODUCT**

Solvent for Noxafil

**2. STATEMENT OF ACTIVE SUBSTANCE(S)**

**3. LIST OF EXCIPIENTS**

Contains methyl parahydroxybenzoate (E218), propyl parahydroxybenzoate, propylene glycol (E1520) and sorbitol solution (E420). See leaflet for further information.

**4. PHARMACEUTICAL FORM AND CONTENTS**

473 mL

**5. METHOD AND ROUTE(S) OF ADMINISTRATION**

**Shake well before use.**

Read the package leaflet and booklet before use.

Oral use

**6. SPECIAL WARNING THAT THE MEDICINAL PRODUCT MUST BE STORED OUT OF THE SIGHT AND REACH OF CHILDREN**

Keep out of the sight and reach of children.

**7. OTHER SPECIAL WARNING(S), IF NECESSARY**

**8. EXPIRY DATE**

EXP

**9. SPECIAL STORAGE CONDITIONS**

**10. SPECIAL PRECAUTIONS FOR DISPOSAL OF UNUSED MEDICINAL PRODUCTS OR WASTE MATERIALS DERIVED FROM SUCH MEDICINAL PRODUCTS, IF APPROPRIATE**

**11. NAME AND ADDRESS OF THE MARKETING AUTHORISATION HOLDER**

Merck Sharp & Dohme B.V.  
Waarderweg 39  
2031 BN Haarlem  
The Netherlands

**12. MARKETING AUTHORISATION NUMBER(S)**

EU/1/05/320/005

**13. BATCH NUMBER**

Lot

**14. GENERAL CLASSIFICATION FOR SUPPLY**

**15. INSTRUCTIONS ON USE**

**16. INFORMATION IN BRAILLE**

**17. UNIQUE IDENTIFIER – 2D BARCODE**

**18. UNIQUE IDENTIFIER - HUMAN READABLE DATA**

**PARTICULARS TO APPEAR ON THE OUTER PACKAGING**

**INNER CARTON (WITHOUT BLUE BOX) – Pack 2 (of 2) – ADDITIONAL SYRINGES to be used with Noxafil gastro-resistant powder and solvent for oral suspension**

**1. NAME OF THE MEDICINAL PRODUCT**

For use only with **Noxafil 300 mg** gastro-resistant powder and solvent for oral suspension kit

**Pack 2 (of 2)**

**2. STATEMENT OF ACTIVE SUBSTANCE(S)**

**3. LIST OF EXCIPIENTS**

**4. PHARMACEUTICAL FORM AND CONTENTS**

This carton contains six 3 mL and six 10 mL notched tip oral dosing syringes individually wrapped

**5. METHOD AND ROUTE(S) OF ADMINISTRATION**

**6. SPECIAL WARNING THAT THE MEDICINAL PRODUCT MUST BE STORED OUT OF THE SIGHT AND REACH OF CHILDREN**

**7. OTHER SPECIAL WARNING(S), IF NECESSARY**

**8. EXPIRY DATE**

EXP

**9. SPECIAL STORAGE CONDITIONS**

**10. SPECIAL PRECAUTIONS FOR DISPOSAL OF UNUSED MEDICINAL PRODUCTS OR WASTE MATERIALS DERIVED FROM SUCH MEDICINAL PRODUCTS, IF APPROPRIATE**

**11. NAME AND ADDRESS OF THE MARKETING AUTHORISATION HOLDER**

Merck Sharp & Dohme B.V.  
Waarderweg 39  
2031 BN Haarlem  
The Netherlands



**12. MARKETING AUTHORISATION NUMBER(S)**

EU/1/05/320/005

**13. BATCH NUMBER**

Lot

**14. GENERAL CLASSIFICATION FOR SUPPLY**

**15. INSTRUCTIONS ON USE**

Read the booklet with instructions provided with the Noxafil 300 mg gastro-resistant powder and solvent for oral suspension kit.

**16. INFORMATION IN BRAILLE**

Not applicable

**17. UNIQUE IDENTIFIER – 2D BARCODE**

**18. UNIQUE IDENTIFIER – HUMAN READABLE DATA**

**B. PACKAGE LEAFLET**

## Package leaflet: Information for the user

### Noxafil 40 mg/mL oral suspension posaconazole

**Read all of this leaflet carefully before you start taking this medicine because it contains important information for you.**

- Keep this leaflet. You may need to read it again.
- If you have any further questions, ask your doctor, pharmacist, or nurse.
- This medicine has been prescribed for you only. Do not pass it on to others. It may harm them, even if their signs of illness are the same as yours.
- If you get any side effects, talk to your doctor, pharmacist or nurse. This includes any possible side effects not listed in this leaflet. See section 4.

#### What is in this leaflet

1. What Noxafil is and what it is used for
2. What you need to know before you take Noxafil
3. How to take Noxafil
4. Possible side effects
5. How to store Noxafil
6. Contents of the pack and other information

#### 1. What Noxafil is and what it is used for

Noxafil contains a medicine called posaconazole. This belongs to a group of medicines called “antifungals”. It is used to prevent and treat many different fungal infections.

This medicine works by killing or stopping the growth of some types of fungi that can cause infections.

Noxafil can be used in adults to treat the following types of fungal infections when other antifungal medicines have not worked or you have had to stop taking them:

- infections caused by fungi of the *Aspergillus* family that have not improved during treatment with the antifungal medicines amphotericin B or itraconazole or when these medicines have had to be stopped;
- infections caused by fungi of the *Fusarium* family that have not improved during treatment with amphotericin B or when amphotericin B has had to be stopped;
- infections caused by fungi that cause the conditions known as “chromoblastomycosis” and “mycetoma” that have not improved during treatment with itraconazole or when itraconazole has had to be stopped;
- infections caused by a fungus called *Coccidioides* that have not improved during treatment with one or more of amphotericin B, itraconazole or fluconazole or when these medicines have had to be stopped;
- Infections in the mouth or throat area (known as “thrush”) caused by fungi called *Candida*, which were not previously treated.

This medicine can also be used to prevent fungal infections in adults who are at high-risk of getting a fungal infection, such as:

- patients who have a weak immune system due to having chemotherapy for “acute myelogenous leukaemia” (AML) or “myelodysplastic syndromes” (MDS)
- patients having “high-dose immunosuppressive therapy” after “hematopoietic stem cell transplant” (HSCT).

## 2. What you need to know before you take Noxafil

### Do not take Noxafil

- if you are allergic to posaconazole or any of the other ingredients of this medicine (listed in section 6).
- if you are taking: terfenadine, astemizole, cisapride, pimozide, halofantrine, quinidine, any medicines that contain “ergot alkaloids” such as ergotamine or dihydroergotamine, or a “statin” such as simvastatin, atorvastatin or lovastatin.
- if you have just started taking venetoclax or your venetoclax dose is being slowly increased for treatment of chronic lymphocytic leukaemia (CLL)

Do not take Noxafil if any of the above apply to you. If you are not sure, talk to your doctor or pharmacist before taking Noxafil.

See “Other medicines and Noxafil” below for more information including information on other medicines which may interact with Noxafil.

### Warnings and precautions

Talk to your doctor, pharmacist or nurse before taking Noxafil if you:

- have had an allergic reaction to another antifungal medicine such as ketoconazole, fluconazole, itraconazole or voriconazole.
- have or have ever had liver problems. You may need to have blood tests while you are taking this medicine.
- develop severe diarrhoea or vomiting, as these conditions may limit the effectiveness of this medicine.
- have an abnormal heart rhythm tracing (ECG) that shows a problem called long QTc interval
- have a weakness of the heart muscle or heart failure
- have a very slow heartbeat
- have heart rhythm disturbance
- have any problem with potassium, magnesium or calcium levels in your blood
- are taking vincristine, vinblastine and other “vinca alkaloids” (medicines used to treat cancer).
- are taking venetoclax (a medicine used to treat cancer).

If any of the above apply to you (or you are not sure), talk to your doctor, pharmacist or nurse before taking Noxafil.

If you develop severe diarrhoea or vomiting (being sick) while taking Noxafil, talk to your doctor, pharmacist or nurse straight away, as this may stop it from working properly. See section 4 for more information.

### Children

Noxafil oral suspension should not be used in children and adolescents (17 years of age and younger).

### Other medicines and Noxafil

Tell your doctor or pharmacist if you are taking, have recently taken or might take any other medicines.

### Do not take Noxafil if you are taking any of the following:

- terfenadine (used to treat allergies)
- astemizole (used to treat allergies)
- cisapride (used to treat stomach problems)
- pimozide (used to treat symptoms of Tourette's and mental illness)
- halofantrine (used to treat malaria)
- quinidine (used to treat abnormal heart rhythms).

Noxafil can increase the amount of these medicines in the blood which may lead to very serious changes to your heart rhythm.

- any medicines that contain “ergot alkaloids” such as ergotamine or dihydroergotamine used to

treat migraines. Noxafil can increase the amount of these medicines in the blood which may lead to a severe decrease in blood flow to your fingers or toes and could cause damage to them.

- a “statin” such as simvastatin, atorvastatin or lovastatin used to treat high cholesterol.
- venetoclax when used at the start of the treatment of a type of cancer, chronic lymphocytic leukaemia (CLL)

Do not take Noxafil if any of the above apply to you. If you are not sure, talk to your doctor or pharmacist before taking this medicine.

#### Other medicines

Look at the list of medicines given above that must not be taken while you are taking Noxafil. In addition to the medicines named above there are other medicines that carry a risk of rhythm problems that may be greater when they are taken with Noxafil. Please make sure you tell your doctor about all the medicines you are taking (prescribed or non-prescribed).

Certain medicines may increase the risk of side effects of Noxafil by increasing the amount of Noxafil in the blood.

The following medicines may decrease the effectiveness of Noxafil by decreasing the amount of Noxafil in the blood:

- rifabutin and rifampicin (used to treat certain infections). If you are already taking rifabutin, you will need a blood test and you will need to look out for some possible side effects of rifabutin.
- phenytoin, carbamazepine, phenobarbital or primidone (used to treat or prevent fits).
- efavirenz and fosamprenavir used to treat HIV infection.
- medicines used to decrease stomach acid such as cimetidine and ranitidine or omeprazole and similar medicines that are called proton pump inhibitors.

Noxafil may possibly increase the risk of side effects of some other medicines by increasing the amount of these medicines in the blood. These medicines include:

- vincristine, vinblastine and other “vinca alkaloids” (used to treat cancer)
- venetoclax (used to treat cancer)
- ciclosporin (used during or after transplant surgery)
- tacrolimus and sirolimus (used during or after transplant surgery)
- rifabutin (used to treat certain infections)
- medicines used to treat HIV called protease inhibitors (including lopinavir and atazanavir, which are given with ritonavir)
- midazolam, triazolam, alprazolam or other “benzodiazepines” (used as sedatives or muscle relaxants)
- diltiazem, verapamil, nifedipine, nisoldipine or other “calcium channel blockers” (used to treat high blood pressure)
- digoxin (used to treat heart failure)
- glipizide or other “sulfonylureas” (used to treat high blood sugar)
- all-trans retinoic acid (ATRA), also called tretinoin (used to treat certain blood cancers).

If any of the above apply to you (or you are not sure), talk to your doctor or pharmacist before taking Noxafil.

#### **Noxafil with food and drink**

To improve absorption of posaconazole, whenever possible it should be taken during or immediately after food or a nutritional drink (see section 3 “How to take Noxafil”). There is no information on the effect of alcohol on posaconazole.

#### **Pregnancy and breast-feeding**

Tell your doctor if you are or think you are pregnant before you start to take Noxafil.

Do not take Noxafil if you are pregnant unless you are told to by your doctor.

If you are a woman who could become pregnant you should use effective contraception while you are taking this medicine. If you become pregnant while you are taking Noxafil, contact your doctor straight away.

Do not breast-feed while taking Noxafil. This is because small amounts may pass into breast milk.

### **Driving and using machines**

You may feel dizzy, sleepy, or have blurred vision while taking Noxafil, which may affect your ability to drive or use tools or machines. If this happens, do not drive or use any tools or machines and contact your doctor.

### **Noxafil contains glucose**

Noxafil contains approximately 1.75 g of glucose per 5 mL of suspension. If you have been told by your doctor that you have an intolerance to some sugars, contact your doctor before taking this medicine.

### **Noxafil contains sodium**

This medicine contains less than 1 mmol sodium (23 mg) per 5 mL of suspension, that is to say essentially 'sodium-free'.

### **Noxafil contains sodium benzoate**

This medicine contains 10 mg of sodium benzoate (E211) per 5 mL of suspension.

### **Noxafil contains benzyl alcohol**

This medicine contains up to 1.25 mg of benzyl alcohol per 5 mL of suspension. Benzyl alcohol may cause allergic reactions.

### **Noxafil contains propylene glycol**

This medicine contains up to 24.75 mg of propylene glycol (E1520) per 5 mL of suspension.

## **3. How to take Noxafil**

Do not switch between Noxafil oral suspension and Noxafil tablets or Noxafil gastro-resistant powder and solvent for oral suspension without talking to your doctor or pharmacist because it may result in a lack of efficacy or an increased risk of adverse reactions.

Always take this medicine exactly as your doctor or pharmacist has told you. Check with your doctor or pharmacist if you are not sure. Your doctor will monitor your response and condition to determine how long Noxafil needs to be given and whether any change is needed to your daily dose.

The table below shows the recommended dose and length of treatment which depend on the type of infection that you have and may be individually adapted for you by your doctor. Do not adapt your dose yourself before consulting your doctor or change your treatment regime.

Whenever possible you should take posaconazole during or immediately after food or a nutritional drink.

<b>Indication</b>	<b>Recommended dose and length of treatment</b>
Treatment of refractory Fungal Infections ( <i>Invasive aspergillosis</i> , <i>Fusariosis</i> , <i>Chromoblastomycosis/Mycetoma</i> , <i>Coccidioidomycosis</i> )	The recommended dose is 200 mg (one 5 mL spoonful) taken four times daily. Alternatively, if recommended by your doctor, you may take 400 mg (two 5 mL spoonfuls) twice a day provided that you are able to take both doses during or after food or a nutritional drink.
First time treatment of Thrush	On the first day of treatment take 200 mg (one 5 mL spoonful) once. After the first day, take 100 mg (2.5 mL) once a day.

Indication	Recommended dose and length of treatment
Prevention of serious Fungal Infections	Take 200 mg (one 5 mL spoonful) three times a day.

### **If you take more Noxafil than you should**

If you are concerned that you may have taken too much, contact your doctor or healthcare professional immediately.

### **If you forget to take Noxafil**

If you have missed a dose, take it as soon as you remember and then carry on as before. However, if it is almost time for your next dose, take your dose when it is due. Do not take a double dose to make up for a forgotten dose.

If you have any further questions on the use of this medicine, ask your doctor, pharmacist or nurse.

## **4. Possible side effects**

Like all medicines, this medicine can cause side effects, although not everybody gets them.

### **Serious side effects**

**Tell your doctor, pharmacist or nurse straight away if you notice any of the following serious side effects – you may need urgent medical treatment:**

- nausea or vomit (feeling or being sick), diarrhoea
- signs of liver problems - these include yellowing of your skin or whites of the eyes, unusually dark urine or pale faeces, feeling sick for no reason, stomach problems, loss of appetite or unusual tiredness or weakness, an increase in liver enzymes shown up in blood tests
- allergic reaction

### **Other side effects**

Tell your doctor, pharmacist or nurse if you notice any of the following side effects:

#### Common: the following may affect up to 1 in 10 people

- a change in the salt level in your blood shown in blood tests - signs include feeling confused or weak
- abnormal skin sensations, such as numbness, tingling, itching, creeping, pricking or burning
- headache
- low potassium levels – shown up in blood tests
- low magnesium levels – shown up in blood tests
- high blood pressure
- loss of appetite, stomach pain or upset stomach, passing wind, dry mouth, changes in your taste
- heartburn (a burning sensation in the chest rising up to the throat)
- low levels of “neutrophils” a type of white blood cell (neutropenia) –this can make you more likely to get infections and be shown up in blood tests
- fever
- feeling weak, dizzy, tired or sleepy
- rash
- itching
- constipation
- rectal discomfort

#### Uncommon: the following may affect up to 1 in 100 people

- anaemia - signs include headaches, feeling tired or dizzy, being short of breath or looking pale and a low level of haemoglobin shown up in blood tests
- low level of platelets (thrombocytopenia) shown in blood tests – this may lead to bleeding

- low level of “leukocytes” a type of white blood cell (leukopenia) shown in blood tests – this can make you more likely to get infections
- high level of “eosinophils” a type of white blood cell (eosinophilia) – this can happen if you have inflammation
- inflammation of the blood vessels
- heart rhythm problems
- fits (convulsions)
- nerve damage (neuropathy)
- abnormal heart rhythm – shown up on a heart trace (ECG), palpitations, slow or fast heartbeat, high or low blood pressure
- low blood pressure
- inflammation of the pancreas (pancreatitis) – this may cause severe stomach pain
- oxygen supply to the spleen is interrupted (splenic infarction) - this may cause severe stomach pain
- severe kidney problems – signs include passing more or less urine, that is a different colour than usual
- high blood levels of creatinine – shown in blood tests
- cough, hiccups
- nose bleeds
- severe sharp chest pain when breathing in (pleuritic pain)
- swelling of lymph glands (lymphadenopathy)
- reduced feeling of sensitivity especially on the skin
- tremor
- high or low blood sugar levels
- blurred vision, sensitivity to light
- hair loss (alopecia)
- mouth ulcers
- shivering, feeling generally unwell
- pain, back or neck pain, pain in arms or legs
- water retention (oedema)
- menstrual problems (abnormal vaginal bleeding)
- inability to sleep (insomnia)
- being completely or partially unable to talk
- swelling of the mouth
- abnormal dreams, or difficulty sleeping
- problems with co-ordination or balance
- mucosal inflammation
- stuffy nose
- difficulty breathing
- chest discomfort
- feeling bloated
- mild to severe nausea, vomiting, cramps and diarrhoea, usually caused by a virus, stomach pain
- belching
- feeling jittery

Rare: the following may affect up to 1 in 1,000 people

- pneumonia – signs include feeling short of breath and producing discoloured phlegm
- high blood pressure in the blood vessels in the lungs (pulmonary hypertension) this can cause serious damage to your lungs and heart
- blood problems such as unusual blood clotting or prolonged bleeding
- severe allergic reactions, including widespread blistering rash and skin peeling
- mental problems such as hearing voices or seeing things that are not there
- fainting



- having problems thinking or talking, having jerking movements, especially in your hands that you cannot control
- stroke – signs include pain, weakness, numbness, or tingling in the limbs
- having a blind or dark spot in your field of vision
- heart failure or heart attack which could lead to the heart stopping beating and death, heart rhythm problems, with sudden death
- blood clots in your legs (deep vein thrombosis) – signs include intense pain or swelling of the legs
- blood clots in your lungs (pulmonary embolism) – signs include feeling short of breath or pain while breathing
- bleeding into your stomach or gut – signs include vomiting blood or passing blood in your stool
- a blockage in your gut (intestinal obstruction) especially in the “ileum”. The blockage will prevent the contents of your intestine from passing through to the lower bowel – signs include feeling bloated, vomiting, severe constipation, loss of appetite, and cramps
- “haemolytic uraemic syndrome” when red blood cells breakup (haemolysis) which may happen with or without kidney failure
- “pancytopenia” low level of all blood cells (red and white blood cells and platelets) shown in blood tests
- large purple discolourations on the skin (thrombotic thrombocytopenic purpura)
- swelling of the face or tongue
- depression
- double vision
- breast pain
- adrenal glands not working properly – this may cause weakness, tiredness, loss of appetite, skin discolouration
- pituitary gland not working properly – this may cause low blood levels of some hormones that affect the function of the male or female sex organs
- hearing problems
- pseudoaldosteronism, which results in high blood pressure with a low potassium level (shown in blood test)

Not known: frequency cannot be estimated from the available data

- some patients have also reported feeling confused after taking Noxafil.

Tell your doctor, pharmacist or nurse if you notice any of the side effects listed above.

### **Reporting of side effects**

If you get any side effects, talk to your doctor, pharmacist or nurse. This includes any possible side effects not listed in this leaflet. You can also report side effects directly via the national reporting system listed in [Appendix V](#). By reporting side effects you can help provide more information on the safety of this medicine.

## **5. How to store Noxafil**

Keep this medicine out of the sight and reach of children.

Do not use this medicine after the expiry date which is stated on the label after EXP. The expiry date refers to the last day of that month.

Do not freeze.

If you have any suspension left in a bottle more than four weeks after it was first opened, you should not use this medicine. Please return the bottle containing any leftover suspension to your pharmacist.

Do not throw away any medicines via wastewater or household waste. Ask your pharmacist how to throw away medicines you no longer use. These measures will help protect the environment.

## 6. Contents of the pack and other information

### What Noxafil contains

- The active substance in Noxafil is posaconazole. Each millilitre of oral suspension contains 40 milligrams of posaconazole.
- The other ingredients in the suspension are polysorbate 80, simeticone, sodium benzoate (E211), sodium citrate dihydrate, citric acid monohydrate, glycerol, xanthan gum, liquid glucose, titanium dioxide (E171), artificial cherry flavour containing benzyl alcohol and propylene glycol (E1520), and purified water.

### What Noxafil looks like and contents of the pack

Noxafil is a white, cherry flavoured, 105 mL oral suspension packaged in amber glass bottles. A measuring spoon is provided with each bottle for measuring 2.5 and 5 mL doses of the oral suspension.

### Marketing Authorisation Holder

Merck Sharp & Dohme B.V.  
Waarderweg 39  
2031 BN Haarlem  
The Netherlands

### Manufacturer

Organon Heist by  
Industriepark 30  
2220 Heist-op-den-Berg  
Belgium

Merck Sharp & Dohme B.V.  
Waarderweg 39  
2031 BN Haarlem  
The Netherlands

For any information about this medicine, please contact the local representative of the Marketing Authorisation Holder:

### België/Belgique/Belgien

MSD Belgium  
Tél/Tel : +32 (0)2 776 62 11  
dpoc\_belux@msd.com

### Lietuva

UAB Merck Sharp & Dohme  
Tel. + 370 5 278 02 47  
msd\_lietuva@merck.com

### България

Мерк Шарп и Доум България ЕООД  
Тел.: +359 2 819 3737  
info-msdbg@merck.com

### Luxembourg/Luxemburg

MSD Belgium  
Tél/Tel : +32 (0)2 776 62 11  
dpoc\_belux@msd.com

### Česká republika

Merck Sharp & Dohme s.r.o.  
Tel: +420 233 010 111  
dpoc\_czechslovak@merck.com

### Magyarország

MSD Pharma Hungary Kft.  
Tel.: +36 1 888 5300  
hungary\_msd@merck.com

### Danmark

MSD Danmark ApS  
Tlf: + 45 44 82 4000  
dkmail@merck.com

### Malta

Merck Sharp & Dohme Cyprus Limited  
Tel.: 8007 4433 (+356 99917558)  
malta\_info@merck.com

**Deutschland**

MSD Sharp & Dohme GmbH  
Tel: 0800 673 673 673 (+ 49 (0) 89 4561 0)  
e-mail@msd.de

**Eesti**

Merck Sharp & Dohme OÜ  
Tel.: + 372 6144 200  
msdeesti@merck.com

**Ελλάδα**

MSD A.Φ.B.E.E.  
Τηλ: +30 210 98 97 300  
dpoc\_greece@merck.com

**España**

Merck Sharp & Dohme de España, S.A.  
Tel: +34 91 321 06 00  
msd\_info@merck.com

**France**

MSD France  
Tél. +33 (0) 1 80 46 40 40

**Hrvatska**

Merck Sharp & Dohme d.o.o.  
Tel: + 385 1 6611 333  
croatia\_info@merck.com

**Ireland**

Merck Sharp & Dohme Ireland (Human Health)  
Limited  
Tel: +353 (0)1 2998700  
medinfo\_ireland@msd.com

**Ísland**

Vistor hf.  
Sími: + 354 535 7000

**Italia**

MSD Italia S.r.l.  
Tel: 800 23 99 89 (+39 06 361911)  
medicalinformation.it@msd.com

**Κύπρος**

Merck Sharp & Dohme Cyprus Limited  
Τηλ.: 800 00 673 (+357 22866700)  
cyprus\_info@merck.com

**Latvija**

SIA Merck Sharp & Dohme Latvija  
Tel: + 371-67364224  
msd\_lv@merck.com

**Nederland**

Merck Sharp & Dohme B.V.  
Tel: 0800 9999000 (+31 23 5153153)  
medicalinfo.nl@merck.com

**Norge**

MSD (Norge) AS  
Tlf: +47 32 20 73 00  
msdnorge@msd.no

**Österreich**

Merck Sharp & Dohme Ges.m.b.H.  
Tel: +43 (0) 1 26 044  
dpoc\_austria@merck.com

**Polska**

MSD Polska Sp. z o.o.  
Tel.: +48 22 549 51 00  
msdpolska@merck.com

**Portugal**

Merck Sharp & Dohme, Lda  
Tel: +351 21 446 5700  
inform\_pt@merck.com

**România**

Merck Sharp & Dohme Romania S.R.L.  
Tel.: + 40 21 529 2900  
msdromania@merck.com

**Slovenija**

Merck Sharp & Dohme, inovativna zdravila  
d.o.o.  
Tel: +386 1 5204 201  
msd.slovenia@merck.com

**Slovenská republika**

Merck Sharp & Dohme, s. r. o.  
Tel: +421 2 58282010  
dpoc\_czechslovak@merck.com

**Suomi/Finland**

MSD Finland Oy  
Puh/Tel: +358 (0)9 804 650  
info@msd.fi

**Sverige**

Merck Sharp & Dohme (Sweden) AB  
Tel: +46 77 5700488  
medicinskinfo@merck.com

**United Kingdom (Northern Ireland)**

Merck Sharp & Dohme Ireland (Human  
Health) Limited  
Tel: +353 (0)1 2998700  
medinfoNI@msd.com

**This leaflet was last revised in <{MM/YYYY}><{month YYYY}>.**

**Other sources of information**

Detailed information on this medicine is available on the European Medicines Agency web site:

<http://www.ema.europa.eu>.

## Package leaflet: Information for the user

### Noxafil 100 mg gastro-resistant tablets posaconazole

**Read all of this leaflet carefully before you start taking this medicine because it contains important information for you.**

- Keep this leaflet. You may need to read it again.
- If you have any further questions, ask your doctor, pharmacist, or nurse.
- This medicine has been prescribed for you only. Do not pass it on to others. It may harm them, even if their signs of illness are the same as yours.
- If you get any side effects, talk to your doctor, pharmacist or nurse. This includes any possible side effects not listed in this leaflet. See section 4.

#### What is in this leaflet

1. What Noxafil is and what it is used for
2. What you need to know before you take Noxafil
3. How to take Noxafil
4. Possible side effects
5. How to store Noxafil
6. Contents of the pack and other information

#### 1. What Noxafil is and what it is used for

Noxafil contains a medicine called posaconazole. This belongs to a group of medicines called “antifungals”. It is used to prevent and treat many different fungal infections.

This medicine works by killing or stopping the growth of some types of fungi that can cause infections.

Noxafil can be used in adults to treat fungal infections caused by fungi of the *Aspergillus* family.

Noxafil can be used in adults and children from 2 years of age weighing more than 40 kg to treat the following types of fungal infections:

- infections caused by fungi of the *Aspergillus* family that have not improved during treatment with the antifungal medicines amphotericin B or itraconazole or when these medicines have had to be stopped;
- infections caused by fungi of the *Fusarium* family that have not improved during treatment with amphotericin B or when amphotericin B has had to be stopped;
- infections caused by fungi that cause the conditions known as “chromoblastomycosis” and “mycetoma” that have not improved during treatment with itraconazole or when itraconazole has had to be stopped;
- infections caused by a fungus called *Coccidioides* that have not improved during treatment with one or more of amphotericin B, itraconazole or fluconazole or when these medicines have had to be stopped.

This medicine can also be used to prevent fungal infections in adults and children from 2 years of age weighing more than 40 kg who are at high-risk of getting a fungal infection, such as:

- patients who have a weak immune system due to having chemotherapy for “acute myelogenous leukaemia” (AML) or “myelodysplastic syndromes” (MDS)
- patients having “high-dose immunosuppressive therapy” after “hematopoietic stem cell transplant” (HSCT).

## **2. What you need to know before you take Noxafil**

### **Do not take Noxafil**

- if you are allergic to posaconazole or any of the other ingredients of this medicine (listed in section 6).
- if you are taking: terfenadine, astemizole, cisapride, pimozide, halofantrine, quinidine, any medicines that contain “ergot alkaloids” such as ergotamine or dihydroergotamine, or a “statin” such as simvastatin, atorvastatin or lovastatin.
- if you have just started taking venetoclax or your venetoclax dose is being slowly increased for treatment of chronic lymphocytic leukaemia (CLL)

Do not take Noxafil if any of the above apply to you. If you are not sure, talk to your doctor or pharmacist before taking Noxafil.

See “Other medicines and Noxafil” below for more information including information on other medicines which may interact with Noxafil.

### **Warnings and precautions**

Talk to your doctor, pharmacist or nurse before taking Noxafil if you:

- have had an allergic reaction to another antifungal medicine such as ketoconazole, fluconazole, itraconazole or voriconazole.
- have or have ever had liver problems. You may need to have blood tests while you are taking this medicine.
- develop severe diarrhoea or vomiting, as these conditions may limit the effectiveness of this medicine.
- have an abnormal heart rhythm tracing (ECG) that shows a problem called long QTc interval
- have a weakness of the heart muscle or heart failure
- have a very slow heartbeat
- have heart rhythm disturbance
- have any problem with potassium, magnesium or calcium levels in your blood
- are taking vincristine, vinblastine and other “vinca alkaloids” (medicines used to treat cancer).
- are taking venetoclax (a medicine used to treat cancer).

If any of the above apply to you (or you are not sure), talk to your doctor, pharmacist or nurse before taking Noxafil.

If you develop severe diarrhoea or vomiting (being sick) while taking Noxafil, talk to your doctor, pharmacist or nurse straight away, as this may stop it from working properly. See section 4 for more information.

### **Children**

Noxafil should not be given to children younger than 2 years of age.

### **Other medicines and Noxafil**

Tell your doctor or pharmacist if you are taking, have recently taken or might take any other medicines.

**Do not take Noxafil if you are taking any of the following:**

- terfenadine (used to treat allergies)
- astemizole (used to treat allergies)
- cisapride (used to treat stomach problems)
- pimozide (used to treat symptoms of Tourette's and mental illness)
- halofantrine (used to treat malaria)
- quinidine (used to treat abnormal heart rhythms).

Noxafil can increase the amount of these medicines in the blood which may lead to very serious changes to your heart rhythm.

- any medicines that contain “ergot alkaloids” such as ergotamine or dihydroergotamine used to treat migraines. Noxafil can increase the amount of these medicines in the blood which may lead to a severe decrease in blood flow to your fingers or toes and could cause damage to them.
- a “statin” such as simvastatin, atorvastatin or lovastatin used to treat high cholesterol.
- venetoclax when used at the start of the treatment of a type of cancer, chronic lymphocytic leukaemia (CLL)

Do not take Noxafil if any of the above apply to you. If you are not sure, talk to your doctor or pharmacist before taking this medicine.

Other medicines

Look at the list of medicines given above that must not be taken while you are taking Noxafil. In addition to the medicines named above there are other medicines that carry a risk of rhythm problems that may be greater when they are taken with Noxafil. Please make sure you tell your doctor about all the medicines you are taking (prescribed or non-prescribed).

Certain medicines may increase the risk of side effects of Noxafil by increasing the amount of Noxafil in the blood.

The following medicines may decrease the effectiveness of Noxafil by decreasing the amount of Noxafil in the blood:

- rifabutin and rifampicin (used to treat certain infections). If you are already taking rifabutin, you will need a blood test and you will need to look out for some possible side effects of rifabutin.
- phenytoin, carbamazepine, phenobarbital or primidone (used to treat or prevent fits).
- efavirenz and fosamprenavir used to treat HIV infection.

Noxafil may possibly increase the risk of side effects of some other medicines by increasing the amount of these medicines in the blood. These medicines include:

- vincristine, vinblastine and other “vinca alkaloids” (used to treat cancer)
- venetoclax (used to treat cancer)
- ciclosporin (used during or after transplant surgery)
- tacrolimus and sirolimus (used during or after transplant surgery)
- rifabutin (used to treat certain infections)
- medicines used to treat HIV called protease inhibitors (including lopinavir and atazanavir, which are given with ritonavir)
- midazolam, triazolam, alprazolam or other “benzodiazepines” (used as sedatives or muscle relaxants)
- diltiazem, verapamil, nifedipine, nisoldipine or other “calcium channel blockers” (used to treat high blood pressure)
- digoxin (used to treat heart failure)
- glipizide or other “sulfonylureas” (used to treat high blood sugar)
- all-trans retinoic acid (ATRA), also called tretinoin (used to treat certain blood cancers).

If any of the above apply to you (or you are not sure), talk to your doctor or pharmacist before taking Noxafil.

### **Pregnancy and breast-feeding**

Tell your doctor if you are or think you are pregnant before you start to take Noxafil.

Do not take Noxafil if you are pregnant unless you are told to by your doctor.

If you are a woman who could become pregnant you should use effective contraception while you are taking this medicine. If you become pregnant while you are taking Noxafil, contact your doctor straight away.

Do not breast-feed while taking Noxafil. This is because small amounts may pass into breast milk.

### **Driving and using machines**

You may feel dizzy, sleepy, or have blurred vision while taking Noxafil, which may affect your ability to drive or use tools or machines. If this happens, do not drive or use any tools or machines and contact your doctor.

### **Noxafil contains sodium**

This medicine contains less than 1 mmol sodium (23 mg) per tablet, that is to say essentially 'sodium-free'.

## **3. How to take Noxafil**

Do not switch between Noxafil tablets and Noxafil oral suspension without talking to your doctor or pharmacist because it may result in a lack of efficacy or an increased risk of adverse reactions.

Always take this medicine exactly as your doctor or pharmacist has told you. Check with your doctor or pharmacist if you are not sure.

### **How much to take**

The usual dose is 300 mg (three 100 mg tablets) twice a day on the first day, then 300 mg (three 100 mg tablets) once a day, thereafter.

The length of treatment may depend on the type of infection that you have and may be individually adapted for you by your doctor. Do not adapt your dose yourself before consulting your doctor or change your treatment regimen.

### **Taking this medicine**

- Swallow the tablet whole with some water.
- Do not crush, chew, break or dissolve the tablet.
- Tablets may be taken with or without food.

### **If you take more Noxafil than you should**

If you think that you may have taken too much Noxafil, talk to a doctor or go to the hospital straight away.

### **If you forget to take Noxafil**

- If you forget a dose, take it as soon as you remember it.
- However, if it is almost time for your next dose, skip the missed dose and go back to your regular schedule.
- Do not take a double dose to make up for a forgotten dose.

If you have any further questions on the use of this medicine, ask your doctor, pharmacist or nurse.

## **4. Possible side effects**

Like all medicines, this medicine can cause side effects, although not everybody gets them.



### **Serious side effects**

**Tell your doctor, pharmacist or nurse straight away if you notice any of the following serious side effects – you may need urgent medical treatment:**

- nausea or vomit (feeling or being sick), diarrhoea
- signs of liver problems - these include yellowing of your skin or whites of the eyes, unusually dark urine or pale faeces, feeling sick for no reason, stomach problems, loss of appetite or unusual tiredness or weakness, an increase in liver enzymes shown up in blood tests
- allergic reaction

### **Other side effects**

Tell your doctor, pharmacist or nurse if you notice any of the following side effects:

#### Common: the following may affect up to 1 in 10 people

- a change in the salt level in your blood shown in blood tests - signs include feeling confused or weak
- abnormal skin sensations, such as numbness, tingling, itching, creeping, pricking or burning
- headache
- low potassium levels – shown up in blood tests
- low magnesium levels – shown up in blood tests
- high blood pressure
- loss of appetite, stomach pain or upset stomach, passing wind, dry mouth, changes in your taste
- heartburn (a burning sensation in the chest rising up to the throat)
- low levels of “neutrophils” a type of white blood cell (neutropenia) – this can make you more likely to get infections and be shown up in blood tests
- fever
- feeling weak, dizzy, tired or sleepy
- rash
- itching
- constipation
- rectal discomfort

#### Uncommon: the following may affect up to 1 in 100 people

- anaemia - signs include headaches, feeling tired or dizzy, being short of breath or looking pale and a low level of haemoglobin shown up in blood tests
- low level of platelets (thrombocytopenia) shown in blood tests – this may lead to bleeding
- low level of “leukocytes” a type of white blood cell (leukopenia) shown in blood tests – this can make you more likely to get infections
- high level of “eosinophils” a type of white blood cell (eosinophilia) – this can happen if you have inflammation
- inflammation of the blood vessels
- heart rhythm problems
- fits (convulsions)
- nerve damage (neuropathy)
- abnormal heart rhythm – shown up on a heart trace (ECG), palpitations, slow or fast heartbeat, high or low blood pressure
- low blood pressure
- inflammation of the pancreas (pancreatitis) – this may cause severe stomach pain
- oxygen supply to the spleen is interrupted (splenic infarction) - this may cause severe stomach pain
- severe kidney problems – signs include passing more or less urine, that is a different colour than usual
- high blood levels of creatinine – shown in blood tests
- cough, hiccups
- nose bleeds
- severe sharp chest pain when breathing in (pleuritic pain)

- swelling of lymph glands (lymphadenopathy)
- reduced feeling of sensitivity especially on the skin
- tremor
- high or low blood sugar levels
- blurred vision, sensitivity to light
- hair loss (alopecia)
- mouth ulcers
- shivering, feeling generally unwell
- pain, back or neck pain, pain in arms or legs
- water retention (oedema)
- menstrual problems (abnormal vaginal bleeding)
- inability to sleep (insomnia)
- being completely or partially unable to talk
- swelling of the mouth
- abnormal dreams, or difficulty sleeping
- problems with co-ordination or balance
- mucosal inflammation
- stuffy nose
- difficulty breathing
- chest discomfort
- feeling bloated
- mild to severe nausea, vomiting, cramps and diarrhoea, usually caused by a virus, stomach pain
- belching
- feeling jittery

Rare: the following may affect up to 1 in 1,000 people

- pneumonia – signs include feeling short of breath and producing discoloured phlegm
- high blood pressure in the blood vessels in the lungs (pulmonary hypertension) this can cause serious damage to your lungs and heart
- blood problems such as unusual blood clotting or prolonged bleeding
- severe allergic reactions, including widespread blistering rash and skin peeling
- mental problems such as hearing voices or seeing things that are not there
- fainting
- having problems thinking or talking, having jerking movements, especially in your hands that you cannot control
- stroke – signs include pain, weakness, numbness, or tingling in the limbs
- having a blind or dark spot in your field of vision
- heart failure or heart attack which could lead to the heart stopping beating and death, heart rhythm problems, with sudden death
- blood clots in your legs (deep vein thrombosis) – signs include intense pain or swelling of the legs
- blood clots in your lungs (pulmonary embolism) – signs include feeling short of breath or pain while breathing
- bleeding into your stomach or gut – signs include vomiting blood or passing blood in your stool
- a blockage in your gut (intestinal obstruction) especially in the “ileum”. The blockage will prevent the contents of your intestine from passing through to the lower bowel – signs include feeling bloated, vomiting, severe constipation, loss of appetite, and cramps
- “haemolytic uraemic syndrome” when red blood cells breakup (haemolysis) which may happen with or without kidney failure
- “pancytopenia” low level of all blood cells (red and white blood cells and platelets) shown in blood tests
- large purple discolourations on the skin (thrombotic thrombocytopenic purpura)
- swelling of the face or tongue
- depression

- double vision
- breast pain
- adrenal glands not working properly – this may cause weakness, tiredness, loss of appetite, skin discolouration
- pituitary gland not working properly – this may cause low blood levels of some hormones that affect the function of the male or female sex organs
- hearing problems
- pseudoaldosteronism, which results in high blood pressure with a low potassium level (shown in blood test)

Not known: frequency cannot be estimated from the available data

- some patients have also reported feeling confused after taking Noxafil.

Tell your doctor, pharmacist or nurse if you notice any of the side effects listed above.

### **Reporting of side effects**

If you get any side effects, talk to your doctor, pharmacist or nurse. This includes any possible side effects not listed in this leaflet. You can also report side effects directly via [the national reporting system](#) listed in [Appendix V](#). By reporting side effects you can help provide more information on the safety of this medicine.

## **5. How to store Noxafil**

Keep this medicine out of the sight and reach of children.

Do not use this medicine after the expiry date which is stated on the blister after EXP. The expiry date refers to the last day of that month.

This medicine does not require any special storage conditions.

Do not throw away any medicines via wastewater or household waste. Ask your pharmacist how to throw away medicines you no longer use. These measures will help protect the environment.

## **6. Contents of the pack and other information**

### **What Noxafil contains**

- The active substance in Noxafil is posaconazole. Each tablet contains 100 mg of posaconazole.
- The other ingredients are: hypromellose acetate succinate; cellulose, microcrystalline; hydroxypropylcellulose (E463); silica dental type; croscarmellose sodium; magnesium stearate, polyvinyl alcohol, macrogol 3350, titanium dioxide (E171), talc, iron oxide yellow (E172).

### **What Noxafil looks like and contents of the pack**

Noxafil gastro-resistant tablets are yellow-coated and capsule-shaped, debossed “100” on one side packaged in a blister in cartons of 24 (2x12) or 96 (8x12) tablets.

Not all pack sizes may be marketed.

**Marketing Authorisation Holder**

Merck Sharp & Dohme B.V.  
Waarderweg 39  
2031 BN Haarlem  
The Netherlands

**Manufacturer**

Organon Heist bv  
Industriepark 30  
2220 Heist-op-den-Berg  
Belgium

Merck Sharp & Dohme B.V.  
Waarderweg 39  
2031 BN Haarlem  
The Netherlands

For any information about this medicine, please contact the local representative of the Marketing Authorisation Holder:

**België/Belgique/Belgien**

MSD Belgium  
Tél/Tel : +32 (0)2 776 62 11  
dpoc\_belux@msd.com

**Lietuva**

UAB Merck Sharp & Dohme  
Tel. + 370 5 278 02 47  
msd\_lietuva@merck.com

**България**

Мерк Шарп и Доум България ЕООД  
Тел.: +359 2 819 3737  
info-msdbg@merck.com

**Luxembourg/Luxemburg**

MSD Belgium  
Tél/Tel : +32 (0)2 776 62 11  
dpoc\_belux@msd.com

**Česká republika**

Merck Sharp & Dohme s.r.o.  
Tel: +420 233 010 111  
dpoc\_czechslovak@merck.com

**Magyarország**

MSD Pharma Hungary Kft.  
Tel.: +36 1 888 5300  
hungary\_msd@merck.com

**Danmark**

MSD Danmark ApS  
Tlf: + 45 44 82 4000  
dkmail@merck.com

**Malta**

Merck Sharp & Dohme Cyprus Limited  
Tel.: 8007 4433 (+356 99917558)  
malta\_info@merck.com

**Deutschland**

MSD Sharp & Dohme GmbH  
Tel: 0800 673 673 673 (+ 49 (0) 89 4561 0)  
e-mail@msd.de

**Nederland**

Merck Sharp & Dohme B.V.  
Tel: 0800 9999000 (+31 23 5153153)  
medicalinfo.nl@merck.com

**Eesti**

Merck Sharp & Dohme OÜ  
Tel.: + 372 6144 200  
msdeesti@merck.com

**Norge**

MSD (Norge) AS  
Tlf: +47 32 20 73 00  
msdnorge@msd.no

**Ελλάδα**

MSD A.Φ.Β.Ε.Ε.  
Τηλ: +30 210 98 97 300  
dpoc\_greece@merck.com

**Österreich**

Merck Sharp & Dohme Ges.m.b.H.  
Tel: +43 (0) 1 26 044  
dpoc\_austria@merck.com

**España**

Merck Sharp & Dohme de España, S.A.  
Tel: +34 91 321 06 00  
msd\_info@merck.com

**Polska**

MSD Polska Sp. z o.o.  
Tel.: +48 22 549 51 00  
msdpolska@merck.com

**France**

MSD France  
Tél. +33 (0) 1 80 46 40 40

**Hrvatska**

Merck Sharp & Dohme d.o.o.  
Tel: + 385 1 6611 333  
croatia\_info@merck.com

**Ireland**

Merck Sharp & Dohme Ireland (Human Health)  
Limited  
Tel: +353 (0)1 2998700  
medinfo\_ireland@msd.com

**Ísland**

Vistor hf.  
Sími: + 354 535 7000

**Italia**

MSD Italia S.r.l.  
Tel: 800 23 99 89 (+39 06 361911)  
medicalinformation.it@msd.com

**Κύπρος**

Merck Sharp & Dohme Cyprus Limited  
Τηλ.: 800 00 673 (+357 22866700)  
cyprus\_info@merck.com

**Latvija**

SIA Merck Sharp & Dohme Latvija  
Tel: + 371-67364224  
msd\_lv@merck.com

**Portugal**

Merck Sharp & Dohme, Lda  
Tel: +351 21 446 5700  
inform\_pt@merck.com

**România**

Merck Sharp & Dohme Romania S.R.L.  
Tel.: + 40 21 529 2900  
msdromania@merck.com

**Slovenija**

Merck Sharp & Dohme, inovativna zdravila  
d.o.o.  
Tel: +386 1 5204 201  
msd.slovenia@merck.com

**Slovenská republika**

Merck Sharp & Dohme, s. r. o.  
Tel: +421 2 58282010  
dpoc\_czechslovak@merck.com

**Suomi/Finland**

MSD Finland Oy  
Puh/Tel: +358 (0)9 804 650  
info@msd.fi

**Sverige**

Merck Sharp & Dohme (Sweden) AB  
Tel: +46 77 5700488  
medicinskinfo@merck.com

**United Kingdom (Northern Ireland)**

Merck Sharp & Dohme Ireland (Human  
Health) Limited  
Tel: +353 (0)1 2998700  
medinfoNI@msd.com

**This leaflet was last revised in <{MM/YYYY}><{month YYYY}>.**

**Other sources of information**

Detailed information on this medicine is available on the European Medicines Agency web site:  
<http://www.ema.europa.eu>.

## Package leaflet: Information for the user

### Noxafil 300 mg concentrate for solution for infusion posaconazole

**Read all of this leaflet carefully before you start using this medicine because it contains important information for you.**

- Keep this leaflet. You may need to read it again.
- If you have any further questions, ask your doctor, pharmacist, or nurse.
- This medicine has been prescribed for you only. Do not pass it on to others. It may harm them, even if their signs of illness are the same as yours.
- If you get any side effects, talk to your doctor, pharmacist or nurse. This includes any possible side effects not listed in this leaflet. See section 4.

#### What is in this leaflet

1. What Noxafil is and what it is used for
2. What you need to know before you use Noxafil
3. How to use Noxafil
4. Possible side effects
5. How to store Noxafil
6. Contents of the pack and other information

#### 1. What Noxafil is and what it is used for

Noxafil contains a medicine called posaconazole. This belongs to a group of medicines called “antifungals”. Noxafil is used to prevent and treat many different fungal infections.

Noxafil works by killing or stopping the growth of some types of fungi that can cause infections.

Noxafil can be used in adults to treat fungal infections caused by fungi of the *Aspergillus* family.

Noxafil can be used in adults and children from 2 years of age to treat the following types of fungal infections:

- infections caused by fungi of the *Aspergillus* family that have not improved during treatment with the antifungal medicines amphotericin B or itraconazole or when these medicines have had to be stopped;
- infections caused by fungi of the *Fusarium* family that have not improved during treatment with amphotericin B or when amphotericin B has had to be stopped;
- infections caused by fungi that cause the conditions known as “chromoblastomycosis” and “mycetoma” that have not improved during treatment with itraconazole or when itraconazole has had to be stopped;
- infections caused by a fungus called *Coccidioides*. that have not improved during treatment with one or more of amphotericin B, itraconazole or fluconazole or when these medicines have had to be stopped.

Noxafil can also be used to prevent fungal infections in adults and children from 2 years of age who are at high-risk of getting a fungal infection, such as:

- patients who have a weak immune system due to having chemotherapy for “acute myelogenous leukaemia” (AML) or “myelodysplastic syndromes” (MDS)
- patients having “high-dose immunosuppressive therapy” after “hematopoietic stem cell transplant” (HSCT).

## 2. What you need to know before you use Noxafil

### Do not use Noxafil

- if you are allergic to posaconazole or any of the other ingredients of this medicine (listed in section 6).
- if you are taking: terfenadine, astemizole, cisapride, pimozide, halofantrine, quinidine, any medicines that contain “ergot alkaloids” such as ergotamine or dihydroergotamine, or a “statin” such as simvastatin, atorvastatin or lovastatin.
- if you have just started taking venetoclax or your venetoclax dose is being slowly increased for treatment of chronic lymphocytic leukaemia (CLL)

Do not use Noxafil if any of the above apply to you. If you are not sure, talk to your doctor or pharmacist before taking Noxafil.

See “Other medicines and Noxafil” below for information on other medicines which may interact with Noxafil.

### Warnings and precautions

Talk to your doctor, pharmacist or nurse before taking Noxafil if you:

- have had an allergic reaction to another antifungal medicine such as ketoconazole, fluconazole, itraconazole or voriconazole.
- have or have ever had liver problems. You may need to have blood tests while you are taking Noxafil.
- have an abnormal heart rhythm tracing (ECG) that shows a problem called long QTc interval
- have a weakness of the heart muscle or heart failure
- have a very slow heartbeat
- have heart rhythm disturbance
- have any problem with potassium, magnesium or calcium levels in your blood
- are taking vincristine, vinblastine and other “vinca alkaloids” (medicines used to treat cancer).
- are taking venetoclax (a medicine used to treat cancer).

If any of the above apply to you (or you are not sure), talk to your doctor, pharmacist or nurse before using Noxafil.

### Children

Noxafil should not be given to children younger than 2 years of age.

### Other medicines and Noxafil

Tell your doctor or pharmacist if you are taking, have recently taken or might take any other medicines.

### Do not take Noxafil if you are taking any of the following:

- terfenadine (used to treat allergies)
- astemizole (used to treat allergies)
- cisapride (used to treat stomach problems)
- pimozide (used to treat symptoms of Tourette's and mental illness)
- halofantrine (used to treat malaria)
- quinidine (used to treat abnormal heart rhythms).

Noxafil can increase the amount of these medicines in the blood which may lead to very serious changes to your heart rhythm.

- any medicines that contain “ergot alkaloids” such as ergotamine or dihydroergotamine used to treat migraines. Noxafil can increase the amount of these medicines in the blood which may lead to a severe decrease in blood flow to your fingers or toes and could cause damage to them.
- a “statin” such as simvastatin, atorvastatin or lovastatin used to treat high cholesterol.
- venetoclax when used at the start of the treatment of a type of cancer, chronic lymphocytic leukaemia (CLL)

Do not take Noxafil if any of the above apply to you. If you are not sure, talk to your doctor or pharmacist before taking Noxafil.

### Other medicines

Look at the list of medicines given above that must not be taken while you are taking Noxafil. In addition to the medicines named above there are other medicines that carry a risk of rhythm problems that may be greater when they are taken with posaconazole. Please make sure you tell your doctor about all the medicines you are taking (prescribed or non-prescribed).

Certain medicines may increase the risk of side effects of Noxafil by increasing the amount of Noxafil in the blood.

The following medicines may decrease the effectiveness of Noxafil by decreasing the amount of Noxafil in the blood:

- rifabutin and rifampicin (used to treat certain infections). If you are already taking rifabutin, you will need a blood test and you will need to look out for some possible side effects of rifabutin.
- phenytoin, carbamazepine, phenobarbital or primidone (used to treat or prevent fits).
- efavirenz and fosamprenavir used to treat HIV infection.

Noxafil may possibly increase the risk of side effects of some other medicines by increasing the amount of these medicines in the blood. These medicines include:

- vincristine, vinblastine and other “vinca alkaloids” (used to treat cancer)
- venetoclax (used to treat cancer)
- ciclosporin (used during or after transplant surgery)
- tacrolimus and sirolimus (used during or after transplant surgery)
- rifabutin (used to treat certain infections)
- medicines used to treat HIV called protease inhibitors (including lopinavir and atazanavir, which are given with ritonavir)
- midazolam, triazolam, alprazolam or other “benzodiazepines” (used as sedatives or muscle relaxants)
- diltiazem, verapamil, nifedipine, nisoldipine or other “calcium channel blockers” (used to treat high blood pressure)
- digoxin (used to treat heart failure)
- glipizide or other “sulfonylureas” (used to treat high blood sugar)
- all-trans retinoic acid (ATRA), also called tretinoin (used to treat certain blood cancers).

If any of the above apply to you (or you are not sure), talk to your doctor or pharmacist before taking Noxafil.

### **Pregnancy and breast-feeding**

Tell your doctor if you are or think you are pregnant before you start to take Noxafil.

Do not use Noxafil if you are pregnant unless you are told to by your doctor.

If you are a woman who could become pregnant you should use effective contraception while you are using Noxafil. If you become pregnant while you are using Noxafil, contact your doctor straight away.

Do not breast-feed while using Noxafil. This is because small amounts may pass into breast milk.

### **Driving and using machines**

You may feel dizzy, sleepy, or have blurred vision while taking Noxafil, which may affect your ability to drive or use tools or machines. If this happens, do not drive or use any tools or machines and contact your doctor.

### **Noxafil contains sodium**

The maximum recommended daily dose of this medicine contains 924 mg sodium (found in table salt). This is equivalent to 46 % of the adult recommended maximum daily dietary intake for sodium.



Talk to your doctor or pharmacist if you need Noxafil 300 mg concentrate for solution for infusion or more daily for a prolonged period, especially if you have been advised to follow a low salt (sodium) diet.

### **Noxafil contains cyclodextrin**

This medicine contains 6,680 mg of cyclodextrin per vial.

## **3. How to use Noxafil**

Always use this medicine exactly as your doctor or pharmacist has told you. Check with your doctor or pharmacist if you are not sure.

The recommended dose for adults is 300 mg twice a day on the first day, then 300 mg once a day, thereafter.

The recommended dose for children aged 2 to less than 18 years, is 6 mg/kg to a maximum of 300 mg twice a day on the first day, then 6 mg/kg to a maximum of 300 mg once a day, thereafter.

Noxafil concentrate for solution for infusion will be diluted to the correct concentration by your pharmacist or nurse.

Noxafil concentrate for solution for infusion will always be prepared and given to you by a healthcare professional.

You will be given Noxafil:

- through a plastic tube placed in your vein (intravenous infusion)
- usually over 90 minutes

The length of treatment may depend on the type of infection that you have or the length of time your immune system is not working properly and may be individually adapted for you by your doctor. Do not adapt your dose yourself before consulting your doctor or change your treatment regimen.

### **If a dose of Noxafil has been forgotten**

As you will be given this medicine under close medical supervision, it is unlikely that a dose would be missed. However, tell your doctor or pharmacist if you think that a dose has been forgotten.

### **When Noxafil treatment is stopped by your doctor you should not experience any effects.**

If you have any further questions on the use of this medicine, ask your doctor, pharmacist or nurse.

## **4. Possible side effects**

Like all medicines, this medicine can cause side effects, although not everybody gets them.

### **Serious side effects**

**Tell your doctor, pharmacist or nurse straight away if you notice any of the following serious side effects – you may need urgent medical treatment:**

- nausea or vomit (feeling or being sick), diarrhoea,
- signs of liver problems, these include yellowing of your skin or whites of the eyes, unusually dark urine or pale faeces, feeling sick for no reason, stomach problems, loss of appetite or unusual tiredness or weakness, an increase in liver enzymes shown up in blood tests
- allergic reaction

## **Other side effects**

Tell your doctor, pharmacist or nurse if you notice any of the following side effects:

### Common: the following may affect up to 1 in 10 people

- a change in the salt level in your blood shown in blood tests signs include feeling confused or weak
- abnormal skin sensations, such as numbness, tingling, itching, creeping, pricking, or burning
- swelling, redness, and tenderness along the vein in which Noxafil was given
- headache
- low potassium levels – shown up in blood tests
- low magnesium levels – shown up in blood tests
- high blood pressure
- loss of appetite, stomach pain or upset stomach, passing wind, dry mouth, changes in your taste
- heartburn (a burning sensation in the chest rising up to the throat)
- low levels of “neutrophils” a type of white blood cell (neutropenia) – this can make you more likely to get infections and be shown up in blood tests
- fever
- feeling weak, dizzy, tired, or sleepy
- rash
- itching
- constipation
- rectal discomfort

### Uncommon: the following may affect up to 1 in 100 people

- anaemia- signs include headaches, feeling tired or dizzy, being short of breath or looking pale and a low level of haemoglobin shown up in blood tests
- low level of platelets (thrombocytopenia) shown in blood tests – this may lead to bleeding
- low level of “leukocytes” a type of white blood cell (leukopenia) shown in blood tests – this can make you more likely to get infections
- high level of “eosinophils” a type of white blood cell (eosinophilia) – this can happen if you have inflammation
- inflammation of the blood vessels
- heart rhythm problems
- fits (convulsions)
- nerve damage (neuropathy)
- abnormal heart rhythm – shown up on a heart trace (ECG), palpitations, slow or fast heartbeat, high or low blood pressure
- low blood pressure
- inflammation of the pancreas (pancreatitis) – this may cause severe stomach pain
- oxygen supply to the spleen is interrupted (splenic infarction) - this may cause severe stomach pain
- severe kidney problems – signs include passing more or less urine that is a different colour than usual
- high blood levels of creatinine – shown in blood tests
- cough, hiccups
- nose bleeds
- severe sharp chest pain when breathing in (pleuritic pain)
- swelling of lymph glands (lymphadenopathy)
- reduced feeling of sensitivity especially on the skin
- tremor
- high or low blood sugar levels
- blurred vision, sensitivity to light
- hair loss (alopecia)
- mouth ulcers
- shivering, feeling generally unwell

- pain, back or neck pain, pain in arms or legs
- water retention (oedema)
- menstrual problems (abnormal vaginal bleeding)
- inability to sleep (insomnia)
- being completely or partially unable to talk
- swelling of the mouth
- abnormal dreams, or difficulty sleeping
- problems with co-ordination or balance
- mucosal inflammation
- stuffy nose
- difficulty breathing
- chest discomfort
- feeling bloated
- mild to severe nausea, vomiting, cramps and diarrhoea, usually caused by a virus, stomach pain
- belching
- feeling jittery
- inflammation or pain at injection site

Rare: the following may affect up to 1 in 1,000 people

- pneumonia – signs include feeling short of breath and producing discoloured phlegm
- high blood pressure in the blood vessels in the lungs (pulmonary hypertension) this can cause serious damage to your lungs and heart
- blood problems such as unusual blood clotting or prolonged bleeding
- severe allergic reactions, including widespread blistering rash and skin peeling
- mental problems such as hearing voices or seeing things that are not there
- fainting
- having problems thinking or talking, having jerking movements, especially in your hands that you cannot control
- stroke – signs include pain, weakness, numbness, or tingling in the limbs
- having a blind or dark spot in your field of vision
- heart failure or heart attack which could lead to the heart stopping beating and death, heart rhythm problems, with sudden death
- blood clots in your legs (deep vein thrombosis) – signs include intense pain or swelling of the legs
- blood clots in your lungs (pulmonary embolism) – signs include feeling short of breath or pain while breathing
- bleeding into your stomach or gut – signs include vomiting blood or passing blood in your stool
- a blockage in your gut (intestinal obstruction) especially in the “ileum”. The blockage will prevent the contents of your intestine from passing through to the lower bowel – signs include feeling bloated, vomiting, severe constipation, loss of appetite, and cramps
- “haemolytic uraemic syndrome” when red blood cells breakup (haemolysis) which may happen with or without kidney failure
- “pancytopenia” low level of all blood cells (red and white blood cells and platelets) shown in blood tests
- large purple discolourations on the skin (thrombotic thrombocytopenic purpura)
- swelling of the face or tongue
- depression
- double vision
- breast pain
- adrenal glands not working properly – this may cause weakness, tiredness, loss of appetite, skin discolouration
- pituitary gland not working properly – this may cause low blood levels of some hormones that affect the function of the male or female sex organs
- hearing problems

- pseudoaldosteronism, which results in high blood pressure with a low potassium level (shown in blood test)

Not known: frequency cannot be estimated from the available data

- some patients have also reported feeling confused after using Noxafil.

Tell your doctor, pharmacist or nurse if you notice any of the side effects listed above.

### **Reporting of side effects**

If you get any side effects, talk to your doctor, pharmacist or nurse. This includes any possible side effects not listed in this leaflet. You can also report side effects directly via the [national reporting system](#) listed in [Appendix V](#). By reporting side effects you can help provide more information on the safety of this medicine.

## **5. How to store Noxafil**

Keep this medicine out of the sight and reach of children.

Do not use this medicine after the expiry date which is stated on the label after EXP. The expiry date refers to the last day of that month.

Store in a refrigerator (2°C–8°C).

Once prepared, the product should be used immediately. If not used immediately, the solution can be stored up to 24 hours at 2°C-8°C (in a refrigerator). This medicine is for single use only and any unused solution should be discarded.

Do not throw away any medicines via wastewater or household waste. Ask your pharmacist how to throw away medicines you no longer use. These measures will help protect the environment.

## **6. Contents of the pack and other information**

### **What Noxafil contains**

- The active substance is posaconazole. Each vial contains 300 mg of posaconazole.
- The other ingredients are: Betadex Sulfobutyl Ether Sodium (SBECD), disodium edetate, hydrochloric acid (concentrated), sodium hydroxide, water for injections.

### **What Noxafil looks like and contents of the pack**

Noxafil concentrate for solution for infusion is a clear, colourless to yellow liquid. Variations of colour within this range do not affect the quality of the product.

This medicine is available in a single use glass vial closed with bromobutyl rubber stopper and aluminium seal.

### **Marketing Authorisation Holder**

Merck Sharp & Dohme B.V.  
 Waarderweg 39  
 2031 BN Haarlem  
 The Netherlands

### **Manufacturer**

Organon Heist bv  
 Industriepark 30  
 2220 Heist-op-den-Berg  
 Belgium

Merck Sharp & Dohme B.V.  
 Waarderweg 39  
 2031 BN Haarlem  
 The Netherlands

For any information about this medicine, please contact the local representative of the Marketing Authorisation Holder:

**België/Belgique/Belgien**

MSD Belgium  
Tél/Tel : +32 (0)2 776 62 11  
dpoc\_belux@msd.com

**България**

Мерк Шарп и Доум България ЕООД  
Тел.: +359 2 819 3737  
info-msdbg@merck.com

**Česká republika**

Merck Sharp & Dohme s.r.o.  
Tel: +420 233 010 111  
dpoc\_czechslovak@merck.com

**Danmark**

MSD Danmark ApS  
Tlf: + 45 44 82 4000  
dkmail@merck.com

**Deutschland**

MSD Sharp & Dohme GmbH  
Tel: 0800 673 673 673 (+ 49 (0) 89 4561 0)  
e-mail@msd.de

**Eesti**

Merck Sharp & Dohme OÜ  
Tel.: + 372 6144 200  
msdeesti@merck.com

**Ελλάδα**

MSD Α.Φ.Β.Ε.Ε.  
Τηλ: +30 210 98 97 300  
dpoc\_greece@merck.com

**España**

Merck Sharp & Dohme de España, S.A.  
Tel: +34 91 321 06 00  
msd\_info@merck.com

**France**

MSD France  
Tél. +33 (0) 1 80 46 40 40

**Hrvatska**

Merck Sharp & Dohme d.o.o.  
Tel: + 385 1 6611 333  
croatia\_info@merck.com

**Lietuva**

UAB Merck Sharp & Dohme  
Tel. + 370 5 278 02 47  
msd\_lietuva@merck.com

**Luxembourg/Luxemburg**

MSD Belgium  
Tél/Tel : +32 (0)2 776 62 11  
dpoc\_belux@msd.com

**Magyarország**

MSD Pharma Hungary Kft.  
Tel.: +36 1 888 5300  
hungary\_msd@merck.com

**Malta**

Merck Sharp & Dohme Cyprus Limited  
Tel.: 8007 4433 (+356 99917558)  
malta\_info@merck.com

**Nederland**

Merck Sharp & Dohme B.V.  
Tel: 0800 9999000 (+31 23 5153153)  
medicalinfo.nl@merck.com

**Norge**

MSD (Norge) AS  
Tlf: +47 32 20 73 00  
msdnorge@msd.no

**Österreich**

Merck Sharp & Dohme Ges.m.b.H.  
Tel: +43 (0) 1 26 044  
dpoc\_austria@merck.com

**Polska**

MSD Polska Sp. z o.o.  
Tel.: +48 22 549 51 00  
msdpolska@merck.com

**Portugal**

Merck Sharp & Dohme, Lda  
Tel: +351 21 446 5700  
inform\_pt@merck.com

**România**

Merck Sharp & Dohme Romania S.R.L.  
Tel.: + 40 21 529 2900  
msdromania@merck.com

**Ireland**

Merck Sharp & Dohme Ireland (Human Health) Limited  
Tel: +353 (0)1 2998700  
medinfo\_ireland@msd.com

**Ísland**

Vistor hf.  
Sími: + 354 535 7000

**Italia**

MSD Italia S.r.l.  
Tel: 800 23 99 89 (+39 06 361911)  
medicalinformation.it@msd.com

**Κύπρος**

Merck Sharp & Dohme Cyprus Limited  
Τηλ.: 800 00 673 (+357 22866700)  
cyprus\_info@merck.com

**Latvija**

SIA Merck Sharp & Dohme Latvija  
Tel: + 371-67364224  
msd\_lv@merck.com

**Slovenija**

Merck Sharp & Dohme, inovativna zdravila d.o.o.  
Tel: +386 1 5204 201  
msd.slovenia@merck.com

**Slovenská republika**

Merck Sharp & Dohme, s. r. o.  
Tel: +421 2 58282010  
dpoc\_czechslovak@merck.com

**Suomi/Finland**

MSD Finland Oy  
Puh/Tel: +358 (0)9 804 650  
info@msd.fi

**Sverige**

Merck Sharp & Dohme (Sweden) AB  
Tel: +46 77 5700488  
medicinskinfo@merck.com

**United Kingdom (Northern Ireland)**

Merck Sharp & Dohme Ireland (Human Health) Limited  
Tel: +353 (0)1 2998700  
medinfoNI@msd.com

**This leaflet was last revised in <{MM/YYYY}><{month YYYY}>.**

**Other sources of information**

Detailed information on this medicine is available on the European Medicines Agency web site:  
<http://www.ema.europa.eu>.

---

**The following information is intended for healthcare professionals only:**

Administration instructions for Noxafil concentrate for solution for infusion

- Equilibrate the refrigerated vial of Noxafil to room temperature.
- Aseptically transfer 16.7 mL of posaconazole to an intravenous bag (or bottle) containing a compatible admixture diluent (see below for list of diluents) using the volume ranging from 150 mL to 283 mL depending on the final concentration to be achieved (not less than 1 mg/mL and not greater than 2 mg/mL).
- Administer via a central venous line, including a central venous catheter or peripherally inserted central catheter (PICC) by slow intravenous infusion over approximately 90 minutes. Noxafil concentrate for solution for infusion should not be given by bolus administration.
- If a central venous catheter is not available, a single infusion may be administered through a peripheral venous catheter with a volume to achieve a dilution of approximately 2 mg/mL. When administered through a peripheral venous catheter, the infusion should be administered over approximately 30 minutes.  
**Note: In clinical studies, multiple peripheral infusions given through the same vein resulted in infusion site reactions (see section 4.8).**
- Noxafil is for single use.

The following medicinal products can be infused at the same time through the same intravenous line (or cannula) as Noxafil concentrate for solution for infusion:

Amikacin sulfate
Caspofungin
Ciprofloxacin
Daptomycin
Dobutamine hydrochloride
Famotidine
Filgrastim
Gentamicin sulfate
Hydromorphone hydrochloride
Levofloxacin
Lorazepam
Meropenem
Micafungin
Morphine sulphate
Norepinephrine bitartrate
Potassium chloride
Vancomycin hydrochloride

Any products not listed in the table above should not be coadministered with Noxafil through the same intravenous line (or cannula).

The infusion solution should be inspected visually for particulate matter prior to administration. The solution of Noxafil ranges from colourless to pale yellow. Variations of colour within this range do not affect the quality of the product.

Any unused medicinal product or waste material should be disposed of in accordance with local requirements.

Noxafil must not be diluted with:

Lactated Ringer's solution
5 % glucose with Lactated Ringer's solution
4.2 % sodium bicarbonate

This medicinal product must not be mixed with other medicinal products except those mentioned below:

- 5 % glucose in water
- 0.9 % sodium chloride
- 0.45 % sodium chloride
- 5 % glucose and 0.45 % sodium chloride
- 5 % glucose and 0.9 % sodium chloride
- 5 % glucose and 20 mEq KCl

## Package leaflet: Information for the user

### Noxafil 300 mg gastro-resistant powder and solvent for oral suspension posaconazole

**Read all of this leaflet carefully before you start taking or giving this medicine to your child because it contains important information for you.**

- Keep this leaflet. You may need to read it again.
- If you have any further questions, ask your doctor, pharmacist, or nurse.
- This medicine has been prescribed for you or your child only. Do not pass it on to others. It may harm them, even if their signs of illness are the same as yours.
- If you get any side effects, talk to your doctor, pharmacist or nurse. This includes any possible side effects not listed in this leaflet. See section 4.

#### What is in this leaflet

1. What Noxafil is and what it is used for
2. What you need to know before you or your child takes Noxafil
3. How to take Noxafil
4. Possible side effects
5. How to store Noxafil
6. Contents of the pack and other information

#### 1. What Noxafil is and what it is used for

Noxafil contains a medicine called posaconazole. This belongs to a group of medicines called “antifungals”. It is used to prevent and treat many different fungal infections.

This medicine works by killing or stopping the growth of some types of fungi that can cause infections.

Noxafil can be used in children from 2 years of age to treat the following types of fungal infections when other antifungal medicines have not worked or you have had to stop taking them:

- infections caused by fungi of the *Aspergillus* family that have not improved during treatment with the antifungal medicines amphotericin B or itraconazole or when these medicines have had to be stopped;
- infections caused by fungi of the *Fusarium* family that have not improved during treatment with amphotericin B or when amphotericin B has had to be stopped;
- infections caused by fungi that cause the conditions known as “chromoblastomycosis” and “mycetoma” that have not improved during treatment with itraconazole or when itraconazole has had to be stopped;
- infections caused by a fungus called *Coccidioides* that have not improved during treatment with one or more of amphotericin B, itraconazole or fluconazole or when these medicines have had to be stopped.

This medicine can also be used to prevent fungal infections in children from 2 years of age who are at high-risk of getting a fungal infection, such as:

- patients who have a weak immune system due to having chemotherapy for “acute myelogenous leukaemia” (AML) or “myelodysplastic syndromes” (MDS).
- patients having “high-dose immunosuppressive therapy” after “hematopoietic stem cell transplant” (HSCT).



## **2. What you need to know before you or your child takes Noxafil**

### **Do not take Noxafil**

- if you or your child is allergic to posaconazole or any of the other ingredients of this medicine (listed in section 6).
- if you or your child is taking: terfenadine, astemizole, cisapride, pimozone, halofantrine, quinidine, any medicines that contain “ergot alkaloids” such as ergotamine or dihydroergotamine, or a “statin” such as simvastatin, atorvastatin or lovastatin.
- if you have just started taking venetoclax or your venetoclax dose is being slowly increased for treatment of chronic lymphocytic leukaemia (CLL)

Do not take Noxafil if any of the above apply to you or your child. If you are not sure, talk to your doctor or pharmacist before taking Noxafil.

See “Other medicines and Noxafil” below for more information including information on other medicines which may interact with Noxafil.

### **Warnings and precautions**

Talk to your doctor, pharmacist or nurse before taking Noxafil if you or your child:

- has had an allergic reaction to another antifungal medicine such as ketoconazole, fluconazole, itraconazole or voriconazole.
- has or have ever had liver problems. You may need to have blood tests while you are taking this medicine.
- develops severe diarrhoea or vomiting, as these conditions may limit the effectiveness of this medicine.
- has an abnormal heart rhythm tracing (ECG) that shows a problem called long QTc interval
- has a weakness of the heart muscle or heart failure
- has a very slow heartbeat
- has heart rhythm disturbance
- has any problem with potassium, magnesium or calcium levels in your blood
- is taking vincristine, vinblastine and other “vinca alkaloids” (medicines used to treat cancer).
- are taking venetoclax (a medicine used to treat cancer).

If any of the above apply to you or your child (or you are not sure), talk to your doctor, pharmacist or nurse before taking Noxafil.

If you develop severe diarrhoea or vomiting (being sick) while taking Noxafil, talk to your doctor, pharmacist or nurse straight away, as this may stop it from working properly. See section 4 for more information.

### **Noxafil gastro-resistant powder and solvent for oral suspension with food and drink**

This medicine can be taken with or without food.

Alcohol may affect the absorption of this medicine.

### **Children**

Noxafil should not be given to children younger than 2 years of age.

### **Other medicines and Noxafil**

Tell your doctor or pharmacist if you or your child is taking, have recently taken or might take any other medicines.

**Do not take Noxafil if you or your child is taking any of the following:**

- terfenadine (used to treat allergies)
- astemizole (used to treat allergies)
- cisapride (used to treat stomach problems)
- pimozide (used to treat symptoms of Tourette's and mental illness)
- halofantrine (used to treat malaria)
- quinidine (used to treat abnormal heart rhythms).

Noxafil can increase the amount of these medicines in the blood which may lead to very serious changes to your heart rhythm.

- any medicines that contain “ergot alkaloids” such as ergotamine or dihydroergotamine used to treat migraines. Noxafil can increase the amount of these medicines in the blood which may lead to a severe decrease in blood flow to your fingers or toes and could cause damage to them.
- a “statin” such as simvastatin, atorvastatin or lovastatin used to treat high cholesterol.
- venetoclax when used at the start of the treatment of a type of cancer, chronic lymphocytic leukaemia (CLL)

Do not take Noxafil if any of the above apply to you or your child. If you are not sure, talk to your doctor or pharmacist before taking this medicine.

Other medicines

Look at the list of medicines given above that must not be taken while you or your child is taking Noxafil. In addition to the medicines named above there are other medicines that carry a risk of rhythm problems that may be greater when they are taken with Noxafil. Please make sure you tell your doctor about all the medicines you or your child is taking (prescribed or non-prescribed).

Certain medicines may increase the risk of side effects of Noxafil by increasing the amount of Noxafil in the blood.

The following medicines may decrease the effectiveness of Noxafil by decreasing the amount of Noxafil in the blood:

- rifabutin and rifampicin (used to treat certain infections). If you are already taking rifabutin, you will need a blood test and you will need to look out for some possible side effects of rifabutin.
- phenytoin, carbamazepine, phenobarbital or primidone (used to treat or prevent fits).
- efavirenz and fosamprenavir used to treat HIV infection.

Noxafil may possibly increase the risk of side effects of some other medicines by increasing the amount of these medicines in the blood. These medicines include:

- vincristine, vinblastine and other “vinca alkaloids” (used to treat cancer)
- venetoclax (used to treat cancer)
- ciclosporin (used during or after transplant surgery)
- tacrolimus and sirolimus (used during or after transplant surgery)
- rifabutin (used to treat certain infections)
- medicines used to treat HIV called protease inhibitors (including lopinavir and atazanavir, which are given with ritonavir)
- midazolam, triazolam, alprazolam or other “benzodiazepines” (used as sedatives or muscle relaxants)
- diltiazem, verapamil, nifedipine, nisoldipine or other “calcium channel blockers” (used to treat high blood pressure)
- digoxin (used to treat heart failure)
- glipizide or other “sulfonylureas” (used to treat high blood sugar)
- all-trans retinoic acid (ATRA), also called tretinoin (used to treat certain blood cancers).

If any of the above apply to you or your child (or you are not sure), talk to your doctor or pharmacist before taking Noxafil.

### **Pregnancy and breast-feeding**

Tell your doctor if you are or think you are pregnant before you start to take Noxafil.

Do not take Noxafil if you are pregnant unless you are told to by your doctor.

If you are a woman who could become pregnant you should use effective contraception while you are taking this medicine. If you become pregnant while you are taking Noxafil, contact your doctor straight away.

Do not breast-feed while taking Noxafil. This is because small amounts may pass into breast milk.

### **Driving and using machines**

You may feel dizzy, sleepy, or have blurred vision while taking Noxafil, which may affect your ability to drive or use tools or machines. If this happens, do not drive or use any tools or machines and contact your doctor.

### **Noxafil contains methyl parahydroxybenzoate and propyl parahydroxybenzoate**

This medicine contains methyl parahydroxybenzoate (E218) and propyl parahydroxybenzoate. May cause allergic reactions (possibly delayed).

### **Noxafil contains sorbitol**

This medicine contains 47 mg sorbitol (E420) per mL.

Sorbitol is a source of fructose. If your doctor has told you that you (or your child) have an intolerance to some sugars or if you have been diagnosed with hereditary fructose intolerance (HFI), a rare genetic disorder in which a person cannot break down fructose, talk to your doctor before you (or your child) take or receive this medicine.

### **Noxafil contains propylene glycol**

This medicine contains 7 mg of propylene glycol (E1520) per mL.

### **Noxafil contains sodium**

This medicine contains less than 1 mmol sodium (23 mg) per dose, that is to say essentially 'sodium-free'.

## **3. How to take Noxafil**

Do not switch between taking Noxafil gastro-resistant powder and solvent for oral suspension and Noxafil oral suspension.

Always give this medicine to your child exactly as their doctor or pharmacist has told you. You should check with your child's doctor or pharmacist if you are not sure.

- See the instructions for use in the booklet for how to prepare and give a dose of Noxafil. Keep the booklet and follow it each time you prepare the medicine. Bring this booklet to your child's appointments.
- Make sure the doctor or pharmacist explains how to mix and give the right dose to your child.
- The powder for oral suspension needs to be mixed with the provided solvent before use. You must give to your child within 30 minutes of mixing.
- ONLY the solvent in the kit should be used to prepare Noxafil.
- To ensure delivery of the correct dose, ONLY the provided notched tip syringes should be used for preparation and administration.
- Make sure to follow the instructions of your doctor. The doctor will tell you if and when to stop giving Noxafil to your child.

### **How much to take**

The recommended dose for children aged 2 to less than 18 years, weighing 10 to 40 kg, is shown in the below table.

<b>Weight (kg)</b>	<b>Dose (volume)</b>
--------------------	----------------------

10-<12 kg	90 mg (3 mL)
12-<17 kg	120 mg (4 mL)
17-<21 kg	150 mg (5 mL)
21-<26 kg	180 mg (6 mL)
26-<36 kg	210 mg (7 mL)
36-40 kg	240 mg (8 mL)

On Day 1 the recommended dose is administered twice.

After Day 1, the recommended dose is administered once daily.

For children weighing > 40 kg, it is recommended to use Noxafil tablets if they can swallow whole tablets.

The length of treatment may depend on the type of infection or the length of time the immune system is not working properly and may be individually changed by the doctor. Do not change the dose or the treatment regimen before consulting the doctor that prescribed the medicine.

### **If you or your child takes more Noxafil than you should**

If you think that you or your child may have taken too much Noxafil, talk to a doctor or go to the hospital straight away.

### **If you forget to take Noxafil**

- If you forget a dose, take it or give it to your child as soon as you remember it.
- However, if it is almost time for the next dose, skip the missed dose and go back to the regular schedule.
- Do not take a double dose to make up for a forgotten dose.

If you have any further questions on the use of this medicine, ask your doctor, pharmacist or nurse.

## **4. Possible side effects**

Like all medicines, this medicine can cause side effects, although not everybody gets them.

### **Serious side effects**

**Tell your doctor, pharmacist or nurse straight away if you notice any of the following serious side effects – you or your child may need urgent medical treatment:**

- nausea or vomit (feeling or being sick), diarrhoea
- signs of liver problems - these include yellowing of your skin or whites of the eyes, unusually dark urine or pale faeces, feeling sick for no reason, stomach problems, loss of appetite or unusual tiredness or weakness, an increase in liver enzymes shown up in blood tests
- allergic reaction

### **Other side effects**

Tell your doctor, pharmacist or nurse if you notice any of the following side effects:

#### Common: the following may affect up to 1 in 10 people

- a change in the salt level in your blood shown in blood tests - signs include feeling confused or weak
- abnormal skin sensations, such as numbness, tingling, itching, creeping, pricking or burning
- headache
- low potassium levels – shown up in blood tests
- low magnesium levels – shown up in blood tests
- high blood pressure
- loss of appetite, stomach pain or upset stomach, passing wind, dry mouth, changes in your taste
- heartburn (a burning sensation in the chest rising up to the throat)

- low levels of “neutrophils” a type of white blood cell (neutropenia) – this can make you more likely to get infections and be shown up in blood tests
- fever
- feeling weak, dizzy, tired or sleepy
- rash
- itching
- constipation
- rectal discomfort

Uncommon: the following may affect up to 1 in 100 people

- anaemia - signs include headaches, feeling tired or dizzy, being short of breath or looking pale and a low level of haemoglobin shown up in blood tests
- low level of platelets (thrombocytopenia) shown in blood tests – this may lead to bleeding
- low level of “leukocytes” a type of white blood cell (leukopenia) shown in blood tests – this can make you more likely to get infections
- high level of “eosinophils” a type of white blood cell (eosinophilia) – this can happen if you have inflammation
- inflammation of the blood vessels
- heart rhythm problems
- fits (convulsions)
- nerve damage (neuropathy)
- abnormal heart rhythm – shown up on a heart trace (ECG), palpitations, slow or fast heartbeat, high or low blood pressure
- low blood pressure
- inflammation of the pancreas (pancreatitis) – this may cause severe stomach pain
- oxygen supply to the spleen is interrupted (splenic infarction) - this may cause severe stomach pain
- severe kidney problems – signs include passing more or less urine, that is a different colour than usual
- high blood levels of creatinine – shown in blood tests
- cough, hiccups
- nose bleeds
- severe sharp chest pain when breathing in (pleuritic pain)
- swelling of lymph glands (lymphadenopathy)
- reduced feeling of sensitivity especially on the skin
- tremor
- high or low blood sugar levels
- blurred vision, sensitivity to light
- hair loss (alopecia)
- mouth ulcers
- shivering, feeling generally unwell
- pain, back or neck pain, pain in arms or legs
- water retention (oedema)
- menstrual problems (abnormal vaginal bleeding)
- inability to sleep (insomnia)
- being completely or partially unable to talk
- swelling of the mouth
- abnormal dreams, or difficulty sleeping
- problems with co-ordination or balance
- mucosal inflammation
- stuffy nose
- difficulty breathing
- chest discomfort
- feeling bloated

- mild to severe nausea, vomiting, cramps and diarrhoea, usually caused by a virus, stomach pain
- belching
- feeling jittery

Rare: the following may affect up to 1 in 1,000 people

- pneumonia – signs include feeling short of breath and producing discoloured phlegm
- high blood pressure in the blood vessels in the lungs (pulmonary hypertension) this can cause serious damage to your lungs and heart
- blood problems such as unusual blood clotting or prolonged bleeding
- severe allergic reactions, including widespread blistering rash and skin peeling
- mental problems such as hearing voices or seeing things that are not there
- fainting
- having problems thinking or talking, having jerking movements, especially in your hands that you cannot control
- stroke – signs include pain, weakness, numbness, or tingling in the limbs
- having a blind or dark spot in your field of vision
- heart failure or heart attack which could lead to the heart stopping beating and death, heart rhythm problems, with sudden death
- blood clots in your legs (deep vein thrombosis) – signs include intense pain or swelling of the legs
- blood clots in your lungs (pulmonary embolism) – signs include feeling short of breath or pain while breathing
- bleeding into your stomach or gut – signs include vomiting blood or passing blood in your stool
- a blockage in your gut (intestinal obstruction) especially in the “ileum”. The blockage will prevent the contents of your intestine from passing through to the lower bowel – signs include feeling bloated, vomiting, severe constipation, loss of appetite, and cramps
- “haemolytic uraemic syndrome” when red blood cells breakup (haemolysis) which may happen with or without kidney failure
- “pancytopenia” low level of all blood cells (red and white blood cells and platelets) shown in blood tests
- large purple discolourations on the skin (thrombotic thrombocytopenic purpura)
- swelling of the face or tongue
- depression
- double vision
- breast pain
- adrenal glands not working properly – this may cause weakness, tiredness, loss of appetite, skin discolouration
- pituitary gland not working properly – this may cause low blood levels of some hormones that affect the function of the male or female sex organs
- hearing problems
- pseudoaldosteronism, which results in high blood pressure with a low potassium level (shown in blood test)

Not known: frequency cannot be estimated from the available data

- some patients have also reported feeling confused after taking Noxafil.

Tell your doctor, pharmacist or nurse if you notice any of the side effects listed above.

**Reporting of side effects**

If you or your child gets any side effects, talk to your doctor, pharmacist or nurse. This includes any possible side effects not listed in this leaflet. You can also report side effects directly via **the national reporting system** listed in [Appendix V](#). By reporting side effects you can help provide more information on the safety of this medicine.

## 5. How to store Noxafil

Keep this medicine out of the sight and reach of children.

Do not use this medicine after the expiry date which is stated on the carton after EXP. The expiry date refers to the last day of that month.

This medicine does not require any special storage conditions.

Do not throw away any medicines or solvent via wastewater. Ask your pharmacist how to throw away medicines you no longer use. These measures will help protect the environment.

See the instructions for use booklet for the right way to dispose of your leftover medicine.

## 6. Contents of the pack and other information

### What Noxafil contains

The active substance is posaconazole. Each single-use sachet of gastro-resistant powder for oral suspension is an off-white to yellow powder containing 300 mg of posaconazole.

The other ingredient is: hypromellose acetate succinate.

The solvent contains the following ingredients: purified water, glycerol (E 422), methyl parahydroxybenzoate (E218), propyl parahydroxybenzoate, sodium dihydrogen phosphate monohydrate, citric acid anhydrous (E330), xanthan gum (E415), sodium citrate (E331), saccharin sodium (E954), microcrystalline cellulose and carmellose sodium, carrageenan calcium sulfate trisodium phosphate (E407), sorbitol solution (E420), potassium sorbate (E202), flavour berry citrus sweet (containing propylene glycol (E1520), water, natural and artificial flavour), antifoam Af emulsion (containing polyethylene glycol (E1521), octamethyl cyclotetrasiloxane, decamethylcyclopentasiloxane and poly(oxy-1,2-ethanediyl), .alpha.-(1-oxooctadecyl)-.omega.-hydroxy).

### What Noxafil looks like and contents of the pack

Noxafil gastro-resistant powder and solvent for oral suspension is supplied as a pack containing:

Package 1: The kit contains 8 child-resistant single-use sachets (PET/aluminium/LLDPE), two 3 mL (green) notched tip syringes, two 10 mL (blue) notched tip syringes, two mixing cups, one 473 mL solvent bottle (HDPE) with polypropylene (PP) closure with a foil induction seal liner, and one bottle adapter for the solvent bottle.

Package 2: A box of six 3 mL (green) and six 10 mL (blue) notched tip syringes.

Each single-use sachet contains 300 mg of posaconazole which is suspended in 9 mL of solvent to obtain 10 mL total of suspension with a final concentration of approximately 30 mg per mL.

### Marketing Authorisation Holder and Manufacturer

Merck Sharp & Dohme B.V.  
Waarderweg 39  
2031 BN Haarlem  
The Netherlands

For any information about this medicine, please contact the local representative of the Marketing Authorisation Holder:

**België/Belgique/Belgien**

MSD Belgium  
Tél/Tel : +32 (0)2 776 62 11  
dpoc\_belux@msd.com

**България**

Мерк Шарп и Доум България ЕООД  
Тел.: +359 2 819 3737  
info-msdbg@merck.com

**Česká republika**

Merck Sharp & Dohme s.r.o.  
Tel: +420 233 010 111  
dpoc\_czechslovak@merck.com

**Danmark**

MSD Danmark ApS  
Tlf: + 45 44 82 4000  
dkmail@merck.com

**Deutschland**

MSD Sharp & Dohme GmbH  
Tel: 0800 673 673 673 (+ 49 (0) 89 4561 0)  
e-mail@msd.de

**Eesti**

Merck Sharp & Dohme OÜ  
Tel.: + 372 6144 200  
msdeesti@merck.com

**Ελλάδα**

MSD A.Φ.Β.Ε.Ε.  
Τηλ: +30 210 98 97 300  
dpoc\_greece@merck.com

**España**

Merck Sharp & Dohme de España, S.A.  
Tel: +34 91 321 06 00  
msd\_info@merck.com

**France**

MSD France  
Tél. +33 (0) 1 80 46 40 40

**Hrvatska**

Merck Sharp & Dohme d.o.o.  
Tel: + 385 1 6611 333  
croatia\_info@merck.com

**Ireland**

Merck Sharp & Dohme Ireland (Human Health)  
Limited  
Tel: +353 (0)1 2998700  
medinfo\_ireland@msd.com

**Lietuva**

UAB Merck Sharp & Dohme  
Tel. + 370 5 278 02 47  
msd\_lietuva@merck.com

**Luxembourg/Luxemburg**

MSD Belgium  
Tél/Tel : +32 (0)2 776 62 11  
dpoc\_belux@msd.com

**Magyarország**

MSD Pharma Hungary Kft.  
Tel.: +36 1 888 5300  
hungary\_msd@merck.com

**Malta**

Merck Sharp & Dohme Cyprus Limited  
Tel.: 8007 4433 (+356 99917558)  
malta\_info@merck.com

**Nederland**

Merck Sharp & Dohme B.V.  
Tel: 0800 9999000 (+31 23 5153153)  
medicalinfo.nl@merck.com

**Norge**

MSD (Norge) AS  
Tlf: +47 32 20 73 00  
msdnorge@msd.no

**Österreich**

Merck Sharp & Dohme Ges.m.b.H.  
Tel: +43 (0) 1 26 044  
dpoc\_austria@merck.com

**Polska**

MSD Polska Sp. z o.o.  
Tel.: +48 22 549 51 00  
msdpolska@merck.com

**Portugal**

Merck Sharp & Dohme, Lda  
Tel: +351 21 446 5700  
inform\_pt@merck.com

**România**

Merck Sharp & Dohme Romania S.R.L.  
Tel.: + 40 21 529 2900  
msdromania@merck.com

**Slovenija**

Merck Sharp & Dohme, inovativna zdravila  
d.o.o.  
Tel: +386 1 5204 201  
msd.slovenia@merck.com



**Ísland**

Vistor hf.  
Sími: + 354 535 7000

**Italia**

MSD Italia S.r.l.  
Tel: 800 23 99 89 (+39 06 361911)  
medicalinformation.it@msd.com

**Κύπρος**

Merck Sharp & Dohme Cyprus Limited  
Τηλ.: 800 00 673 (+357 22866700)  
cyprus\_info@merck.com

**Latvija**

SIA Merck Sharp & Dohme Latvija  
Tel: + 371-67364224  
msd\_lv@merck.com

**Slovenská republika**

Merck Sharp & Dohme, s. r. o.  
Tel: +421 2 58282010  
dpoc\_czechslovak@merck.com

**Suomi/Finland**

MSD Finland Oy  
Puh/Tel: +358 (0)9 804 650  
info@msd.fi

**Sverige**

Merck Sharp & Dohme (Sweden) AB  
Tel: +46 77 5700488  
medicinskinfo@merck.com

**United Kingdom (Northern Ireland)**

Merck Sharp & Dohme Ireland (Human Health) Limited  
Tel: +353 (0)1 2998700  
medinfoNI@msd.com

**This leaflet was last revised in <{MM/YYYY}><{month YYYY}>.**

**Other sources of information**

Detailed information on this medicine is available on the European Medicines Agency web site:  
<http://www.ema.europa.eu>.

## Instructions for Use

### Noxafil 300 mg gastro-resistant powder and solvent for oral suspension posaconazole

#### Instructions for Use for caregivers of toddlers and children

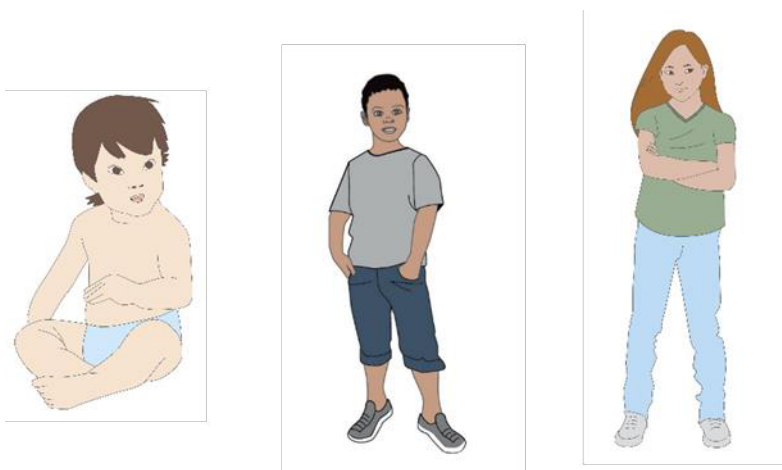

- **Make sure you read and understand these instructions for use.**
- **Bring this booklet to your child's appointments.**

#### Before you start

- Before you start, make sure that you read and understand all of these instructions. They may be different than those for medicines that you have used in the past.
- It is important that you make all measurements very carefully.
- Before you give Noxafil, check all 3 expiry dates. The expiry date is printed on the box (Figure 1), the Noxafil sachets (Figure 2), and the solvent (Figure 3).
- Do not open the Noxafil sachets until you are ready to mix the dose.



Figure 1

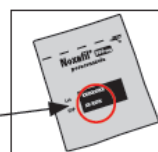

Figure 2



Figure 3

**Note:** If you have any questions, talk to your doctor or pharmacist.





## Before you start

- The amount of Noxafil you give depends on your child's weight. Your doctor will tell you the right dose to give your child. Make sure to keep your doctor's appointments so you get new dosing information as your child grows.
- This booklet tells you how to:
  - Make the Noxafil into a liquid form
  - Measure the right dose using an oral syringe
  - Give the Noxafil to your child
  - Clean up

**Note:** Put your child in a safe place. You will need both hands to prepare Noxafil. Wash your hands with soap and water before preparing Noxafil.

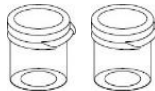
**Note before adding Noxafil:** Make sure you and your child are ready. If you do not use Noxafil within **30 minutes**, you will need to throw it away and start over.

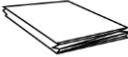
## Kit Contents

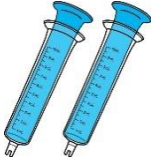
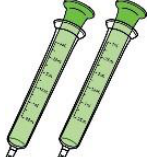
- Outer carton 
  - 2 mixing cups 
  - Instructions for use (this booklet)
  - 8 sachets of Noxafil powder 
  - Package leaflet 
  - Bottle adapter 
  - 4 syringes (shown below)
  - Bottle of solvent for use with Noxafil 
-  **2 blue (10 mL) syringes**
-  **2 green (3 mL) syringes**

**The kit has an extra cup and set of syringes in case one is lost or damaged. Do not use any damaged cups or syringes.**

## Get to Know the Oral Syringes

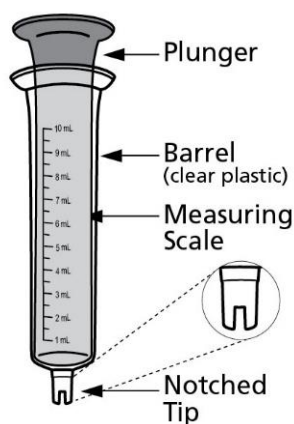

- Before you prepare a dose, review the parts of the syringe and how to use them.
  - If you have any questions about measuring with a syringe, talk to your doctor or pharmacist.
  - Make sure the plunger is pushed all the way into the barrel before you start to measure the dose.
- 
- Look for the number on the measuring scale that matches the amount of solvent or Noxafil that you need.
  - Make sure to follow the directions in this booklet to remove air bubbles from the syringe. **Air bubbles can affect the amount of medicine that the child gets.**

### Step 1. Get the solvent ready

**Note:** Noxafil needs to be prepared using the solvent.

**Do not** mix Noxafil with milk, juice, or water.



When you use the solvent for the first time:

- Open the bottle and remove the safety seal. Use scissors if needed.
- Place the bottle adapter on top of the bottle with the small hole facing up.
- **Push the bottle adapter all the way down.**
- Once in place, the bottle adapter stays in the bottle.
- Put the cap back on the bottle.

## Step 2. Gather all your supplies and put on a clean surface

**Note:** Put your child in a safe place. You will need both hands to prepare Noxafil. Wash your hands with soap and water before preparing Noxafil.



**1 mixing cup**  
(Using the tab on the mixing cup, pull open the lid.)



**1 sachet of Noxafil powder**



**Solvent**

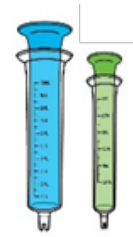

**1 blue syringe and 1 green syringe**  
(Have 1 of each ready, but you may only use 1, depending on the dose.)



**Scissors**  
(not included with kit: use sharp household or kitchen scissors)

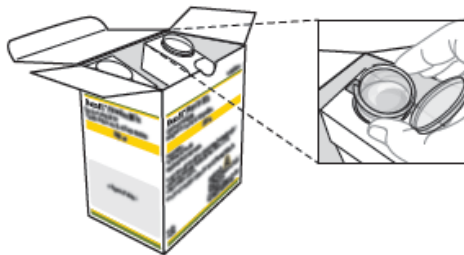

The Noxafil box has a mixing cup holder inside to help tilt the cup when you are measuring the dose.

## Step 3. Add Noxafil to the mixing cup

### **Note before adding Noxafil:**

Make sure you and your child are ready. If you do not use Noxafil within **30 minutes**, you will need to throw it away and start over.

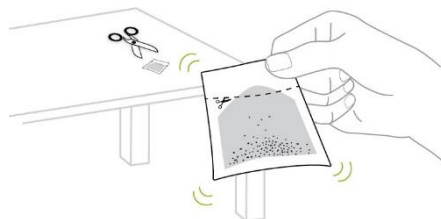

Figure 1

- Take **1 sachet** of Noxafil and shake the powder to the bottom of the sachet. (Figure 1)

- Cut open the sachet at the dotted line and add all of the powder to the mixing cup. Make sure the sachet is completely empty. (Figure 2)

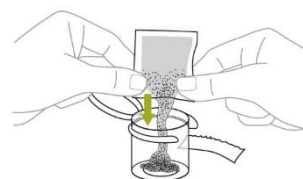

Figure 2

#### Step 4. Shake the solvent bottle



- Shake the solvent well before each time you prepare Noxafil.

#### Step 5. Fill the blue syringe with 9 mL of solvent

- Push the plunger of the **blue** syringe into the syringe barrel as far as it goes.
- Remove the cap from the bottle of solvent.
- Push the notched tip of the syringe into the bottle adapter.
- With the syringe attached to the bottle, turn the bottle and syringe upside down. With your other hand, pull back the plunger to draw the solvent back into the syringe.
- Stop when you get to the 9 mL line.
- Turn the bottle back over and remove the syringe to check your measurement.

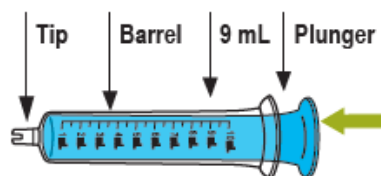

### Step 6. Check for air bubbles

- Hold the syringe with notched tip up. Tap it with your finger to move any air bubbles.
- Slowly push the plunger to make the air come out. (Figure 1)

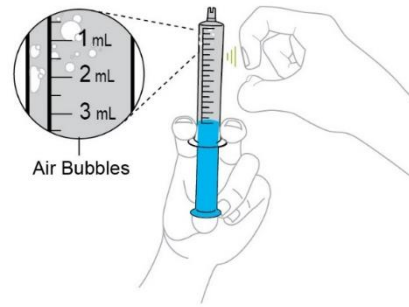
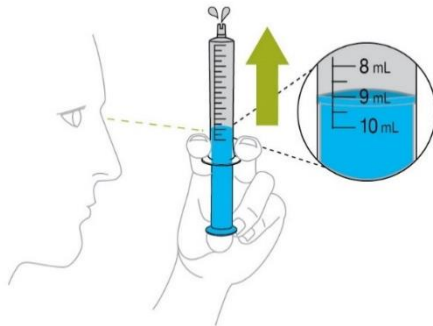

Figure 1



- Re-check the measurement of the solvent in the syringe. If it is less than 9 mL, put the notched tip back into the solvent and pull the plunger back until you get to the 9 mL mark. (Figure 2)

Figure 2

### Step 7. Add the 9 mL of solvent to the Noxafil

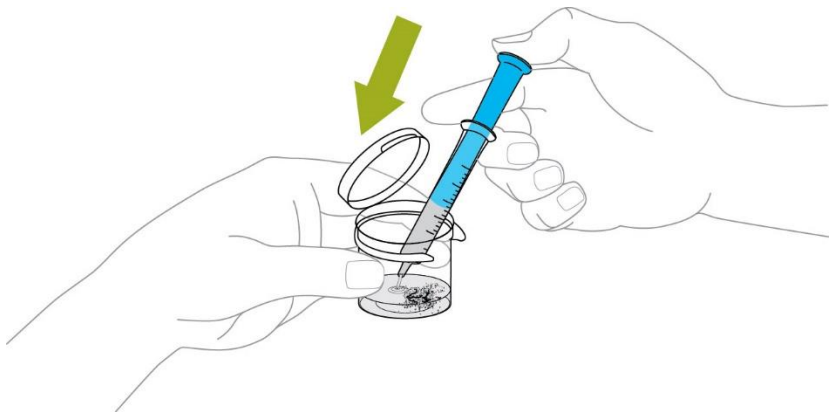

- Add the 9 mL of solvent to the Noxafil powder in the mixing cup by pushing all the way down on the plunger.

### Step 8. Mix the Noxafil

- Snap the lid of the mixing cup shut.
- Shake the mixing cup really hard for 45 seconds to mix the Noxafil. (Figure 1)

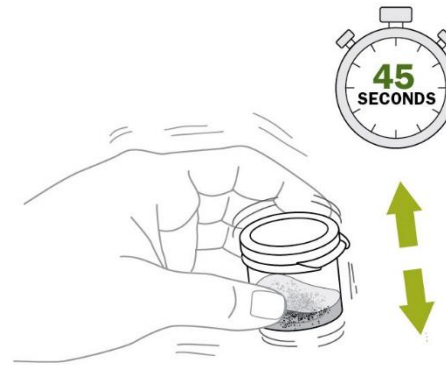
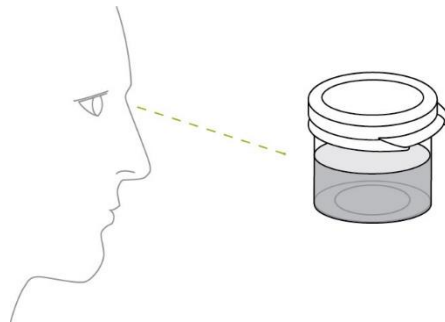

Figure 1



- Check to make sure the powder is mixed. If it is not mixed, shake the mixing cup some more. Noxafil should look cloudy and free of clumps. (Figure 2)

Figure 2

### Step 9. Check your prescription

- Use the dose amount in 'mL' prescribed by the doctor.

**Note:** The dose may change each time you go to the doctor, so make sure you have all the recent information. Be sure to go to all of your child's doctor appointments so your child gets the right dose.

### Step 10. Choose the syringe you need

**Note:** Only use the syringes provided in the kit.

Choose the correct syringe for your child's dose:

For 1 mL  
to 3 mL  
Green



For 3 mL  
to 10 mL  
Blue

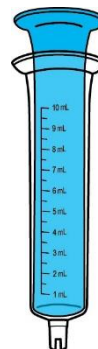

- Then find the mL mark on the syringe that matches your child's dose.



## Step 11. Measure the Noxafil

- Push the plunger into the dosing syringe as far as it goes. (Figure 1)
- Tilt the cup by hand or use the mixing cup holder inside the Noxafil box. (Figure 2)
- Put the notched tip of the dosing syringe into the lowest part of the cup with the Noxafil and pull back the plunger. (Figure 3)
- Stop when you get to the line showing the prescribed dose.



Figure 1

Figure 2

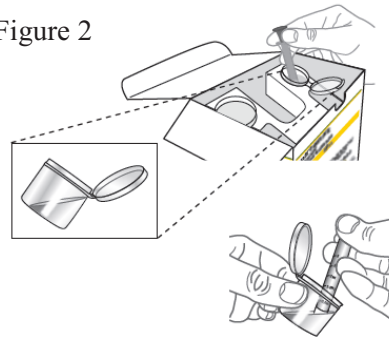

Figure 3

**Note:** You will not use all of the Noxafil. There will be some left over in the mixing cup.

## Step 12. Check for air bubbles

- Hold the syringe with notched tip up. Tap it with your finger to move any air bubbles.
- Slowly push the plunger to make the air come out. (Figure 1)

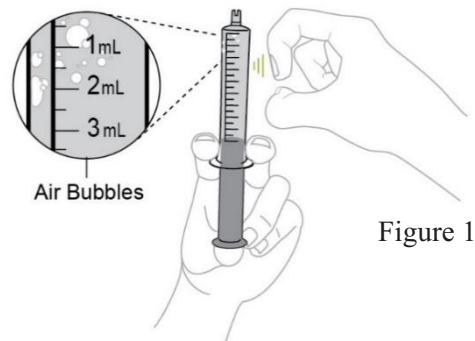

Figure 1

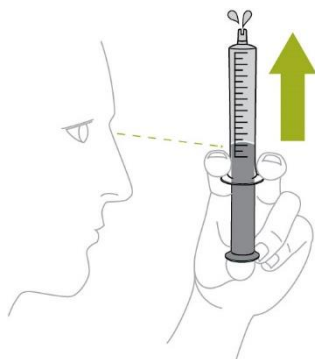

Figure 2

- Re-check the measurement of Noxafil in the syringe. If it is less than the prescribed dose, put the notched tip back into the mixing cup with the Noxafil and pull the plunger back until you get to the right dose mark. (Figure 2)

### Step 13. Give the Noxafil to your child

- Gently place the syringe inside your child's mouth so that the notched tip touches the inside of their cheek.
- Slowly push down on the plunger to give the dose of Noxafil. It is important that your child takes all of the dose (a little left in the syringe notched tip is ok).



#### Note:

- If your child vomits or spits out the whole dose within 15 minutes of taking Noxafil, a dose may be repeated once. Follow-up your doctor or pharmacist if this occurs.
- Only use the solvent from the kit. Do not mix Noxafil with milk, juice, or water.

### Step 14. Clean the cup and syringes

**Note:** Syringes and mixing cups should be reused. Do not throw away syringes and mixing cups provided until all the Noxafil sachets are used. If syringes cannot be washed and reused, additional syringes are provided in pack 2.

- Pour the leftover Noxafil from the mixing cup into the household waste bin.  
**Do not pour it into the sink.**
- Pull the plungers out of any syringes you used.
- Hand wash the syringes, plungers, and mixing cup with warm water and washing-up liquid. **Do not wash in the dishwasher.**
- Rinse with water and air dry.
- Put everything in a clean, dry place.

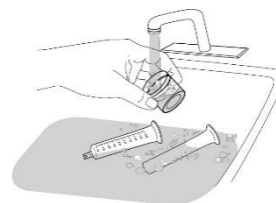
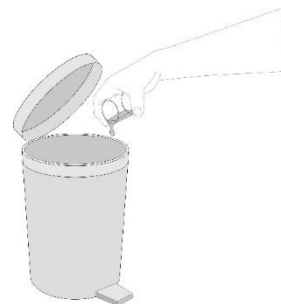

### Step 15. After all sachets of Noxafil have been used

- After you have used the last Noxafil sachet in this box, you will have leftover solvent in the bottle. Throw away the leftover solvent and all components of the kit.