

ANNEX I
SUMMARY OF PRODUCT CHARACTERISTICS

1. NAME OF THE MEDICINAL PRODUCT

ORENCIA 250 mg powder for concentrate for solution for infusion

2. QUALITATIVE AND QUANTITATIVE COMPOSITION

Each vial contains 250 mg of abatacept.

Each mL contains 25 mg of abatacept, after reconstitution.

Abatacept is a fusion protein produced by recombinant DNA technology in Chinese hamster ovary cells.

Excipient with known effect

sodium: 0.375 mmol (8.625 mg) per vial

For the full list of excipients, see section 6.1.

3. PHARMACEUTICAL FORM

Powder for concentrate for solution for infusion.

The powder is a white to off-white whole or fragmented cake.

4. CLINICAL PARTICULARS

4.1 Therapeutic indications

Rheumatoid arthritis

ORENCIA, in combination with methotrexate, is indicated for:

- the treatment of moderate to severe active rheumatoid arthritis (RA) in adult patients who responded inadequately to previous therapy with one or more disease-modifying anti-rheumatic drugs (DMARDs) including methotrexate (MTX) or a tumour necrosis factor (TNF)-alpha inhibitor.
- the treatment of highly active and progressive disease in adult patients with rheumatoid arthritis not previously treated with methotrexate.

A reduction in the progression of joint damage and improvement of physical function have been demonstrated during combination treatment with abatacept and methotrexate.

Psoriatic arthritis

ORENCIA, alone or in combination with methotrexate (MTX), is indicated for the treatment of active psoriatic arthritis (PsA) in adult patients when the response to previous DMARD therapy including MTX has been inadequate, and for whom additional systemic therapy for psoriatic skin lesions is not required.

Polyarticular juvenile idiopathic arthritis

ORENCIA in combination with methotrexate is indicated for the treatment of moderate to severe active polyarticular juvenile idiopathic arthritis (pJIA) in paediatric patients 6 years of age and older who have had an inadequate response to previous DMARD therapy.

ORENCIA can be given as monotherapy in case of intolerance to methotrexate or when treatment with methotrexate is inappropriate.

4.2 Posology and method of administration

Treatment should be initiated and supervised by specialist physicians experienced in the diagnosis and treatment of rheumatoid arthritis or pJIA.

If a response to abatacept is not present within 6 months of treatment, the continuation of the treatment should be reconsidered (see section 5.1).

Posology

Rheumatoid arthritis

Adults

To be administered as a 30-minute intravenous infusion at the dose specified in Table 1. Following the initial administration, ORENCIA should be given 2 and 4 weeks after the first infusion, then every 4 weeks thereafter.

Table 1: Dose of ORENCIA^a

Body Weight of Patient	Dose	Number of Vials ^b
< 60 kg	500 mg	2
≥ 60 kg to ≤ 100 kg	750 mg	3
> 100 kg	1,000 mg	4

^a Approximating 10 mg/kg.

^b Each vial provides 250 mg of abatacept for administration.

No dose adjustment is required when used in combination with other DMARDs, corticosteroids, salicylates, nonsteroidal anti-inflammatory drugs (NSAIDs), or analgesics.

Psoriatic arthritis

Adults

To be administered as a 30-minute intravenous infusion at the dose specified in Table 1. Following the initial administration, ORENCIA should be given 2 and 4 weeks after the first infusion, then every 4 weeks thereafter.

Paediatric population

Polyarticular juvenile idiopathic arthritis

The recommended dose of ORENCIA for patients 6 to 17 years of age with polyarticular juvenile idiopathic arthritis who weigh less than 75 kg is 10 mg/kg calculated based on the patient's body weight at each administration. Paediatric patients weighing 75 kg or more should be administered ORENCIA following the adult dosing regimen, not to exceed a maximum dose of 1,000 mg. ORENCIA should be administered as a 30-minute intravenous infusion. Following the initial administration, ORENCIA should be given at 2 and 4 weeks after the first infusion and every 4 weeks thereafter.

The safety and efficacy of intravenous ORENCIA in children below 6 years of age have not been studied and therefore, intravenous ORENCIA is not recommended for use in children under six years old.

ORENCIA solution for injection in pre-filled syringe for subcutaneous administration is available for paediatric patients 2 years of age and older for the treatment of pJIA (see Summary of Product Characteristics for ORENCIA solution for injection in pre-filled syringe).

Special populations

Elderly patients

No dose adjustment is required (see section 4.4).

Renal and hepatic impairment

ORENCIA has not been studied in these patient populations. No dose recommendations can be made.

Method of administration

For intravenous use.

The entire, fully diluted ORENCIA solution should be administered over a period of 30 minutes and must be administered with an infusion set and a sterile, non-pyrogenic, low-protein-binding filter (pore size of 0.2 to 1.2 µm). For instructions on reconstitution and dilution of the medicinal product before administration, see section 6.6.

4.3 Contraindications

Hypersensitivity to the active substance or to any of the excipients listed in section 6.1.

Severe and uncontrolled infections such as sepsis and opportunistic infections (see section 4.4).

4.4 Special warnings and precautions for use

Combination with TNF-inhibitors

There is limited experience with use of abatacept in combination with TNF-inhibitors (see section 5.1). In placebo-controlled clinical trials, in comparison with patients treated with TNF-inhibitors and placebo, patients who received combination TNF-inhibitors with abatacept experienced an increase in overall infections and serious infections (see section 4.5). Abatacept is not recommended for use in combination with TNF-inhibitors.

While transitioning from TNF-inhibitor therapy to ORENCIA therapy, patients should be monitored for signs of infection (see section 5.1, study VII).

Allergic reactions

Allergic reactions have been reported uncommonly with abatacept administration in clinical trials, where patients were not required to be pretreated to prevent allergic reactions (see section 4.8). Anaphylaxis or anaphylactoid reactions can occur after the first infusion and can be life-threatening. In postmarketing experience, a case of fatal anaphylaxis following the first infusion of ORENCIA has been reported. If any serious allergic or anaphylactic reaction occurs, intravenous or subcutaneous ORENCIA therapy should be discontinued immediately and appropriate therapy initiated, and the use of ORENCIA should be permanently discontinued.

Effects on the immune system

Medicinal products which affect the immune system, including ORENCIA, may affect host defences against infections and malignancies, and affect vaccination responses.

Co-administration of ORENCIA with biologic immunosuppressive or immunomodulatory agents could potentiate the effects of abatacept on the immune system (see section 4.5).

Infections

Serious infections, including sepsis and pneumonia, have been reported with abatacept (see section 4.8). Some of these infections have been fatal. Many of the serious infections have occurred in patients on concomitant immunosuppressive therapy which in addition to their underlying disease, could further predispose them to infections. Treatment with ORENCIA should not be initiated in patients with active infections until infections are controlled. Physicians should exercise caution when considering the use of ORENCIA in patients with a history of recurrent infections or underlying conditions which may predispose them to infections. Patients who develop a new infection while undergoing treatment with ORENCIA should be monitored closely. Administration of ORENCIA should be discontinued if a patient develops a serious infection.

No increase of tuberculosis was observed in the pivotal placebo-controlled studies; however, all ORENCIA patients were screened for tuberculosis. The safety of ORENCIA in individuals with latent tuberculosis is unknown. There have been reports of tuberculosis in patients receiving ORENCIA (see section 4.8). Patients should be screened for latent tuberculosis prior to initiating ORENCIA. The available medical guidelines should also be taken into account.

Anti-rheumatic therapies have been associated with hepatitis B reactivation. Therefore, screening for viral hepatitis should be performed in accordance with published guidelines before starting therapy with ORENCIA.

Progressive multifocal leukoencephalopathy (PML)

Cases of PML have been reported in patients receiving abatacept mostly in combination with other immunosuppressive medication. PML can be fatal and should be considered in the differential diagnosis in immunosuppressed patients with new onset or worsening neurological, psychiatric and cognitive symptoms. If symptoms suggestive of PML occur during ORENCIA therapy, treatment with ORENCIA should be discontinued and appropriate diagnostic measures initiated.

Malignancies

In the placebo-controlled clinical trials, the frequencies of malignancies in abatacept- and placebo-treated patients were 1.2% and 0.9%, respectively (see section 4.8). Patients with known malignancies were not included in these clinical trials. In carcinogenicity studies in mice, an increase in lymphomas and mammary tumours were noted. The clinical significance of this observation is unknown (see section 5.3). The potential role of abatacept in the development of malignancies, including lymphoma, in humans is unknown. There have been reports of non-melanoma skin cancers in patients receiving ORENCIA (see section 4.8). Periodic skin examination is recommended for all patients, particularly those with risk factors for skin cancer.

Vaccinations

Patients treated with ORENCIA may receive concurrent vaccinations, except for live vaccines. Live vaccines should not be given concurrently with abatacept or within 3 months of its discontinuation. Medicinal products that affect the immune system, including abatacept, may blunt the effectiveness of some immunisations.

It is recommended that patients with juvenile idiopathic arthritis be brought up to date with all immunisations in agreement with current immunisation guidelines prior to initiating ORENCIA therapy (see section 4.5).

Elderly patients

A total of 404 patients 65 years of age and older, including 67 patients 75 years and older, received abatacept in placebo-controlled clinical trials. Similar efficacy was observed in these patients and in younger patients. The frequencies of serious infection and malignancy relative to placebo among abatacept-treated patients over age 65 were higher than among those under age 65. Because there is a higher incidence of infections and malignancies in the elderly in general, caution should be used when treating the elderly (see section 4.8).

Autoimmune processes

There is a theoretical concern that treatment with abatacept might increase the risk for autoimmune processes in adults and children, for example deterioration of multiple sclerosis. In the placebo-controlled clinical trials, abatacept treatment did not lead to increased autoantibody formation, such as antinuclear and anti-dsDNA antibodies, relative to placebo treatment (see sections 4.8 and 5.3).

Blood glucose testing

Parenteral medicinal products containing maltose can interfere with the readings of blood glucose monitors that use test strips with glucose dehydrogenase pyrroloquinoline quinone (GDH-PQQ). The GDH-PQQ based glucose monitoring systems may react with the maltose present in ORENCIA, resulting in falsely elevated blood glucose readings on the day of infusion. When receiving ORENCIA, patients that require blood glucose monitoring should be advised to consider methods that do not react with maltose, such as those based on glucose dehydrogenase nicotinic adenine dinucleotide (GDH-NAD), glucose oxidase, or glucose hexokinase test methods.

Patients on controlled sodium diet

This medicinal product contains 34.5 mg sodium per maximum dose of 4 vials (8.625 mg sodium per vial), equivalent to 1.7% of the WHO recommended maximum daily intake of 2 g sodium for an adult.

Traceability

In order to improve the traceability of biological medicinal products, the name and the batch number of the administered product should be clearly recorded.

4.5 Interaction with other medicinal products and other forms of interaction

Combination with TNF-inhibitors

There is limited experience with the use of abatacept in combination with TNF-inhibitors (see section 5.1). While TNF-inhibitors did not influence abatacept clearance, in placebo-controlled clinical trials, patients receiving concomitant treatment with abatacept and TNF-inhibitors experienced more infections and serious infections than patients treated with only TNF-inhibitors. Therefore, concurrent therapy with abatacept and a TNF-inhibitor is not recommended.

Combination with other medicinal products

Population pharmacokinetic analyses did not detect any effect of methotrexate, NSAIDs, and corticosteroids on abatacept clearance (see section 5.2).

No major safety issues were identified with use of abatacept in combination with sulfasalazine, hydroxychloroquine, or leflunomide.

Combination with other medicinal products that affect the immune system and with vaccinations

Co-administration of abatacept with biologic immunosuppressive or immunomodulatory agents could potentiate the effects of abatacept on the immune system. There is insufficient evidence to assess the safety and efficacy of abatacept in combination with anakinra or rituximab (see section 4.4).

Vaccinations

Live vaccines should not be given concurrently with abatacept or within 3 months of its discontinuation. No data are available on the secondary transmission of infection from persons receiving live vaccines to patients receiving abatacept. Medicinal products that affect the immune system, including abatacept, may blunt the effectiveness of some immunisations (see sections 4.4 and 4.6).

Exploratory studies to assess the effect of abatacept on the antibody response to vaccination in healthy subjects as well as the antibody response to influenza and pneumococcal vaccines in rheumatoid arthritis patients suggested that abatacept may blunt the effectiveness of the immune response, but did not significantly inhibit the ability to develop a clinically significant or positive immune response.

Abatacept was evaluated in an open-label study in rheumatoid arthritis patients administered the 23-valent pneumococcal vaccine. After pneumococcal vaccination, 62 of 112 abatacept-treated patients were able to mount an adequate immune response of at least a 2-fold increase in antibody titers to pneumococcal polysaccharide vaccine.

Abatacept was also evaluated in an open-label study in rheumatoid arthritis patients administered the seasonal influenza trivalent virus vaccine. After influenza vaccination, 73 of 119 abatacept-treated patients without protective antibody levels at baseline were able to mount an adequate immune response of at least a 4-fold increase in antibody titers to trivalent influenza vaccine.

4.6 Fertility, pregnancy and lactation

Pregnancy and women of childbearing potential

There are no adequate data from use of abatacept in pregnant women. In pre-clinical embryo-foetal development studies no undesirable effects were observed at doses up to 29-fold a human 10 mg/kg dose based on AUC. In a pre- and postnatal development study in rats, limited changes in immune function were observed at 11-fold higher than a human 10 mg/kg dose based on AUC (see section 5.3).

ORENCIA should not be used during pregnancy unless the clinical condition of the woman requires treatment with abatacept. Women of childbearing potential have to use effective contraception during treatment and up to 14 weeks after the last dose of abatacept.

Abatacept may cross the placenta into the serum of infants born to women treated with abatacept during pregnancy. Consequently, these infants may be at increased risk of infection. The safety of administering live vaccines to infants exposed to abatacept *in utero* is unknown. Administration of live vaccines to infants exposed to abatacept *in utero* is not recommended for 14 weeks following the mother's last exposure to abatacept during pregnancy.

Breast-feeding

Abatacept has been shown to be present in rat milk.

It is unknown whether abatacept is excreted in human milk.

A risk to the newborns/infants cannot be excluded.

Breast-feeding should be discontinued during treatment with ORENCIA and for up to 14 weeks after the last dose of abatacept treatment.

Fertility

Formal studies of the potential effect of abatacept on human fertility have not been conducted.

In rats, abatacept had no undesirable effects on male or female fertility (see section 5.3).

4.7 Effects on ability to drive and use machines

Based on its mechanism of action, abatacept is expected to have no or negligible influence on the ability to drive and use machines. However, dizziness and reduced visual acuity have been reported as

common and uncommon adverse reactions respectively from patients treated with ORENCIA, therefore if a patient experiences such symptoms, driving and use of machinery should be avoided.

4.8 Undesirable effects

Summary of the safety profile in rheumatoid arthritis

Abatacept has been studied in patients with active rheumatoid arthritis in placebo-controlled clinical trials (2,653 patients with abatacept, 1,485 with placebo).

In placebo-controlled clinical trials with abatacept, adverse reactions (ARs) were reported in 49.4% of abatacept-treated patients and 45.8% of placebo-treated patients. The most frequently reported adverse reactions ($\geq 5\%$) among abatacept-treated patients were headache, nausea, and upper respiratory tract infections (including sinusitis). The proportion of patients who discontinued treatment due to ARs was 3.0% for abatacept-treated patients and 2.0% for placebo-treated patients.

Summary of the safety profile in psoriatic arthritis

Abatacept has been studied in patients with active psoriatic arthritis in two placebo-controlled clinical trials (341 patients with abatacept, 253 patients with placebo) (see section 5.1). During the 24-week placebo-controlled period in the larger study PsA-II, the proportion of patients with adverse reactions was similar in the abatacept and placebo treatment groups (15.5% and 11.4%, respectively). There were no adverse reactions that occurred at $\geq 2\%$ in either treatment group during the 24-week placebo-controlled period. The overall safety profile was comparable between studies PsA-I and PsA-II and consistent with the safety profile in rheumatoid arthritis (Table 2).

Tabulated list of adverse reactions

Listed in Table 2 are adverse reactions observed in clinical trials and post-marketing experience presented by system organ class and frequency, using the following categories: very common ($\geq 1/10$); common ($\geq 1/100$ to $< 1/10$); uncommon ($\geq 1/1,000$ to $< 1/100$); rare ($\geq 1/10,000$ to $< 1/1,000$); very rare ($< 1/10,000$). Within each frequency grouping, undesirable effects are presented in order of decreasing seriousness.

Table 2: Adverse reactions

Infections and infestations	Very Common	Upper respiratory tract infection (including tracheitis, nasopharyngitis, and sinusitis)
	Common	Lower respiratory tract infection (including bronchitis), urinary tract infection, herpes infections (including herpes simplex, oral herpes, and herpes zoster), pneumonia, influenza
	Uncommon	Tooth infection, onychomycosis, sepsis, musculoskeletal infections, skin abscess, pyelonephritis, rhinitis, ear infection
	Rare	Tuberculosis, bacteraemia, gastrointestinal infection, pelvic inflammatory disease
Neoplasms benign, malignant and unspecified (incl. cysts and polyps)	Uncommon	Basal cell carcinoma, skin papilloma
	Rare	Lymphoma, lung neoplasm malignant, squamous cell carcinoma

Blood and lymphatic system disorders	Uncommon	Thrombocytopenia, leukopenia
Immune system disorders	Uncommon	Hypersensitivity
Psychiatric disorders	Uncommon	Depression, anxiety, sleep disorder (including insomnia)
Nervous system disorders	Common Uncommon	Headache, dizziness Migraine, paraesthesia
Eye disorders	Uncommon	Conjunctivitis, dry eye, visual acuity reduced
Ear and labyrinth disorders	Uncommon	Vertigo
Cardiac disorders	Uncommon	Palpitations, tachycardia, bradycardia
Vascular disorders	Common Uncommon	Hypertension, blood pressure increased Hypotension, hot flush, flushing, vasculitis, blood pressure decreased
Respiratory, thoracic and mediastinal disorders	Common Uncommon	Cough Chronic obstructive pulmonary disease exacerbated, bronchospasm, wheezing, dyspnoea, throat tightness
Gastrointestinal disorders	Common Uncommon	Abdominal pain, diarrhoea, nausea, dyspepsia, mouth ulceration, aphthous stomatitis, vomiting Gastritis
Hepatobiliary disorders	Common	Liver function test abnormal (including transaminases increased)
Skin and subcutaneous tissue disorders	Common Uncommon	Rash (including dermatitis) Increased tendency to bruise, dry skin, alopecia, pruritus, urticaria, psoriasis, acne, erythema, hyperhidrosis
Musculoskeletal and connective tissue disorders	Uncommon	Arthralgia, pain in extremity

Reproductive system and breast disorders	Uncommon	Amenorrhea, menorrhagia
General disorders and administration site conditions	Common Uncommon	Fatigue, asthenia Influenza like illness, weight increased

Description of selected adverse reactions

Infections

In the placebo-controlled clinical trials with abatacept, infections at least possibly related to treatment were reported in 22.7% of abatacept-treated patients and 20.5% of placebo-treated patients.

Serious infections at least possibly related to treatment were reported in 1.5% of abatacept-treated patients and 1.1% of placebo-treated patients. The type of serious infections was similar between the abatacept and placebo treatment groups (see section 4.4).

The incidence rates (95% CI) for serious infections was 3.0 (2.3, 3.8) per 100 patient-years for abatacept-treated patients and 2.3 (1.5, 3.3) per 100 patient-years for placebo-treated patients in the double-blind studies.

In the cumulative period in clinical trials in 7,044 patients treated with abatacept during 20,510 patient-years, the incidence rate of serious infections was 2.4 per 100 patient-years, and the annualised incidence rate remained stable.

Malignancies

In placebo-controlled clinical trials, malignancies were reported in 1.2% (31/2,653) of abatacept-treated patients and in 0.9% (14/1,485) of placebo-treated patients. The incidence rates for malignancies was 1.3 (0.9, 1.9) per 100 patient-years for abatacept-treated patients and 1.1 (0.6, 1.9) per 100 patient-years for placebo-treated patients.

In the cumulative period 7,044 patients treated with abatacept during 21,011 patient-years (of which over 1,000 were treated with abatacept for over 5 years), the incidence rate of malignancy was 1.2 (1.1, 1.4) per 100 patient-years, and the annualised incidence rates remained stable.

The most frequently reported malignancy in the placebo-controlled clinical trials was non-melanoma skin cancer; 0.6 (0.3, 1.0) per 100 patient-years for abatacept-treated patients and 0.4 (0.1, 0.9) per 100 patient-years for placebo-treated patients and 0.5 (0.4, 0.6) per 100 patient-years in the cumulative period.

The most frequently reported organ cancer in the placebo-controlled clinical trials was lung cancer 0.17 (0.05, 0.43) per 100 patient-years for abatacept-treated patients, 0 for placebo-treated patients and 0.12 (0.08, 0.17) per 100 patient-years in the cumulative period. The most common hematologic malignancy was lymphoma 0.04 (0, 0.24) per 100 patient-years for abatacept-treated patients, 0 for placebo-treated patients and 0.06 (0.03, 0.1) per 100 patient-years in the cumulative period.

Infusion-related reactions

Acute infusion-related events (adverse reactions occurring within 1 hour of the start of the infusion) in seven pooled intravenous studies (for studies II, III, IV and V see section 5.1) were more common in the abatacept-treated patients than the placebo-treated patients (5.2% for abatacept, 3.7% for placebo). The most frequently reported event with abatacept (1-2%) was dizziness.

Acute infusion-related events that were reported in > 0.1% and ≤ 1% of patients treated with abatacept included cardiopulmonary symptoms such as hypotension, decreased blood pressure, tachycardia, bronchospasm, and dyspnoea; other symptoms included myalgia, nausea, erythema, flushing, urticaria,

hypersensitivity, pruritus, throat tightness, chest discomfort, chills, infusion site extravasation, infusion site pain, infusion site swelling, infusion related reaction, and rash. Most of these reactions were mild to moderate.

The occurrence of anaphylaxis remained rare during the double blind and the cumulative period. Hypersensitivity was reported uncommonly. Other reactions potentially associated with hypersensitivity to the medicinal product, such as hypotension, urticaria, and dyspnoea, that occurred within 24 hours of ORENCIA infusion, were uncommon.

Discontinuation due to an acute infusion-related reaction occurred in 0.3% of patients receiving abatacept and in 0.1% of placebo-treated patients.

Adverse reactions in patients with chronic obstructive pulmonary disease (COPD)

In study IV, there were 37 patients with COPD treated with intravenous abatacept and 17 treated with placebo. The COPD patients treated with abatacept developed adverse reactions more frequently than those treated with placebo (51.4% vs. 47.1%, respectively). Respiratory disorders occurred more frequently in abatacept-treated patients than in placebo-treated patients (10.8% vs. 5.9%, respectively); these included COPD exacerbation, and dyspnoea. A greater percentage of abatacept- than placebo-treated patients with COPD developed a serious adverse reaction (5.4% vs. 0%), including COPD exacerbation (1 of 37 patients [2.7%]) and bronchitis (1 of 37 patients [2.7%]).

Autoimmune processes

Abatacept therapy did not lead to increased formation of autoantibodies, i.e., antinuclear and anti-dsDNA antibodies, compared with placebo.

The incidence rate of autoimmune disorders in abatacept-treated patients during the double-blind period was 8.8 (7.6, 10.1) per 100 person-years of exposure and for placebo-treated patients was 9.6 (7.9, 11.5) per 100 person-years of exposure. The incidence rate in abatacept-treated patients was 3.8 per 100 person-years in the cumulative period. The most frequently reported autoimmune-related disorders other than the indication being studied during the cumulative period were psoriasis, rheumatoid nodule, and Sjogren's syndrome.

Immunogenicity

Antibodies directed against the abatacept molecule were assessed by ELISA assays in 3,985 rheumatoid arthritis patients treated for up to 8 years with abatacept. One hundred and eighty seven of 3,877 (4.8%) patients developed anti-abatacept antibodies while on treatment. In patients assessed for anti-abatacept antibodies after discontinuation of abatacept (> 42 days after last dose), 103 of 1,888 (5.5%) were seropositive.

Samples with confirmed binding activity to CTLA-4 were assessed for the presence of neutralizing antibodies. Twenty-two of 48 evaluable patients showed significant neutralizing activity. The potential clinical relevance of neutralizing antibody formation is not known.

Overall, there was no apparent correlation of antibody development to clinical response or adverse events. However, the number of patients that developed antibodies was too limited to make a definitive assessment. Because immunogenicity analyses are product-specific, comparison of antibody rates with those from other products is not appropriate.

Safety information related to the pharmacological class

Abatacept is the first selective co-stimulation modulator. Information on the relative safety in a clinical trial versus infliximab is summarised in section 5.1.

Paediatric population

Abatacept has been studied in patients with pJIA in two clinical trials (pJIA SC study and pJIA IV study). The pJIA SC study included 46 patients in the 2 to 5 year age cohort and 173 patients in the 6 to 17 year age cohort. The pJIA IV study included 190 patients in the 6 to 17 year age cohort. During

the first 4-month open-label period, the overall safety profile in these 409 pJIA patients was similar to that observed in the RA population with the following exceptions in the pJIA patients:

- Common adverse reactions: pyrexia
- Uncommon adverse reactions: haematuria, otitis (media and externa).

Description of selected adverse reactions

Infections

Infections were the most commonly reported adverse events in patients with pJIA. The types of infections were consistent with those commonly seen in outpatient paediatric populations. During the first 4-month treatment period of intravenous and subcutaneous abatacept in 409 patients with pJIA, the most common adverse reactions were nasopharyngitis (3.7% patients) and upper respiratory tract infection (2.9% patients). Two serious infections (varicella and sepsis) were reported during the initial 4 months of treatment with abatacept.

Infusion-related reactions

Of the 190 patients with pJIA treated with intravenous ORENCIA, one (0.5%) patient discontinued due to non-consecutive infusion reactions, consisting of bronchospasm and urticaria. During Periods A, B, and C, acute infusion-related reactions occurred at a frequency of 4%, 2%, and 4%, respectively, and were consistent with the types of reactions reported in adults.

Immunogenicity

Antibodies directed against the entire abatacept molecule or to the CTLA-4 portion of abatacept were assessed by ELISA assays in patients with pJIA following repeated treatment with intravenous ORENCIA. The rate of seropositivity while patients were receiving abatacept therapy was 0.5% (1/189) during Period A; 13.0% (7/54) during Period B; and 12.8% (19/148) during Period C. For patients in Period B who were randomised to placebo (therefore withdrawn from therapy for up to 6 months) the rate of seropositivity was 40.7% (22/54). Anti-abatacept antibodies were generally transient and of low titer. The absence of concomitant methotrexate (MTX) did not appear to be associated with a higher rate of seropositivity in Period B placebo recipients. The presence of antibodies was not associated with adverse reactions or infusion reactions, or with changes in efficacy or serum abatacept concentrations. Of the 54 patients withdrawn from ORENCIA during the double-blind period for up to 6 months, none had an infusion reaction upon re-initiation of ORENCIA.

Long-term extension period

During the extension period of the pJIA studies (20 months in the pJIA SC study and 5 years in the pJIA IV study), the safety profile in the pJIA patients aged 6 to 17 years was comparable to that seen in adult patients. One patient was diagnosed with multiple sclerosis while in the extension period of the pJIA IV study. One serious adverse reaction of infection (limb abscess) was reported in the 2 to 5 year age cohort during the 20-month extension period of the pJIA SC study.

Long-term safety data in 2 to 5 year age cohort with pJIA was limited, but the existing evidence did not reveal any new safety concern in this younger paediatric population. During the 24-month cumulative period of the pJIA SC study (4-month short term period plus 20-month extension period), a higher frequency of infections was reported in the 2 to 5 year age cohort (87.0%) compared to that reported in the 6 to 17 year age cohort (68.2%). This was mostly due to non-serious upper respiratory tract infections in the 2 to 5 year age cohort.

Reporting of suspected adverse reactions

Reporting suspected adverse reactions after authorisation of the medicinal product is important. It allows continued monitoring of the benefit/risk balance of the medicinal product. Healthcare professionals are asked to report any suspected adverse reactions via **the national reporting system** listed in [Appendix V](#).

4.9 Overdose

Doses up to 50 mg/kg have been administered without apparent toxic effect. In case of overdose, it is recommended that the patient be monitored for any signs or symptoms of adverse reactions and appropriate symptomatic treatment instituted.

5. PHARMACOLOGICAL PROPERTIES

5.1 Pharmacodynamic properties

Pharmacotherapeutic group: Immunosuppressants, selective immunosuppressants, ATC code: L04AA24

Abatacept is a fusion protein that consists of the extracellular domain of human cytotoxic T-lymphocyte-associated antigen 4 (CTLA-4) linked to a modified Fc portion of human immunoglobulin G1 (IgG1). Abatacept is produced by recombinant DNA technology in Chinese hamster ovary cells.

Mechanism of action

Abatacept selectively modulates a key costimulatory signal required for full activation of T lymphocytes expressing CD28. Full activation of T lymphocytes requires two signals provided by antigen presenting cells: recognition of a specific antigen by a T cell receptor (signal 1) and a second, costimulatory signal. A major costimulatory pathway involves the binding of CD80 and CD86 molecules on the surface of antigen presenting cells to the CD28 receptor on T lymphocytes (signal 2). Abatacept selectively inhibits this costimulatory pathway by specifically binding to CD80 and CD86. Studies indicate that naive T lymphocyte responses are more affected by abatacept than memory T lymphocyte responses.

Studies *in vitro* and in animal models demonstrate that abatacept modulates T lymphocyte-dependent antibody responses and inflammation. *In vitro*, abatacept attenuates human T lymphocyte activation as measured by decreased proliferation and cytokine production. Abatacept decreases antigen specific TNF α , interferon- γ , and interleukin-2 production by T lymphocytes.

Pharmacodynamic effects

Dose-dependent reductions were observed with abatacept in serum levels of soluble interleukin-2 receptor, a marker of T lymphocyte activation; serum interleukin-6, a product of activated synovial macrophages and fibroblast-like synoviocytes in rheumatoid arthritis; rheumatoid factor, an autoantibody produced by plasma cells; and C-reactive protein, an acute phase reactant of inflammation. In addition, serum levels of matrix metalloproteinase-3, which produces cartilage destruction and tissue remodelling, were decreased. Reductions in serum TNF α were also observed.

Clinical efficacy and safety in adult rheumatoid arthritis

The efficacy and safety of intravenous abatacept were assessed in randomised, double-blind, placebo-controlled clinical trials in adult patients with active rheumatoid arthritis diagnosed according to American College of Rheumatology (ACR) criteria. Studies I, II, III, V, and VI required patients to have at least 12 tender and 10 swollen joints at randomisation. Study IV did not require any specific number of tender or swollen joints.

In studies I, II, and V the efficacy and safety of abatacept compared to placebo were assessed in patients with an inadequate response to methotrexate and who continued on their stable dose of methotrexate. In addition, study V investigated the safety and efficacy of abatacept or infliximab relative to placebo. In study III the efficacy and safety of abatacept were assessed in patients with an inadequate response to a TNF-inhibitor, with the TNF-inhibitor discontinued prior to randomisation;

other DMARDs were permitted. Study IV primarily assessed safety in patients with active rheumatoid arthritis requiring additional intervention in spite of current therapy with non-biological and/or biological DMARDs; all DMARDs used at enrollment were continued. In study VI, the efficacy and safety of abatacept were assessed in methotrexate-naïve, Rheumatoid Factor (RF) and/or anti-Cyclic Citrullinated Peptide 2 (Anti-CCP2)-positive patients with early, erosive rheumatoid arthritis (≤ 2 years disease duration) who were randomised to receive abatacept plus methotrexate or methotrexate plus placebo. Study SC-II investigated the relative efficacy and safety of abatacept and adalimumab, both given subcutaneously without an intravenous loading dose and with background MTX, in patients with moderate to severely active RA and an inadequate response to previous MTX therapy. In study SC-III, abatacept subcutaneous was evaluated in combination with methotrexate (MTX), or as abatacept monotherapy, and compared to MTX monotherapy in induction of remission following 12 months of treatment, and the possible maintenance of drug-free remission after complete drug withdrawal, in adult MTX-naïve patients with highly active early, rheumatoid arthritis (mean DAS28-CRP of 5.4; mean symptom duration less than 6.7 months) with poor prognostic factors for rapidly progressive disease (e.g., anti-citrullinated protein antibodies [ACPA+], as measured by anti-CCP2 assay, and/or RF+, baseline joint erosions).

Study I patients were randomised to receive abatacept 2 or 10 mg/kg or placebo for 12 months. Study II, III, IV, and VI patients were randomised to receive a fixed dose approximating 10 mg/kg of abatacept or placebo for 12 (studies II, IV, and VI) or 6 months (study III). The dose of abatacept was 500 mg for patients weighing less than 60 kg, 750 mg for patients weighing 60 to 100 kg, and 1,000 mg for patients weighing greater than 100 kg. Study V patients were randomised to receive this same fixed dose of abatacept or 3 mg/kg infliximab or placebo for 6 months. Study V continued for an additional 6 months with the abatacept and infliximab groups only.

Studies I, II, III, IV, V, VI, SC-II, and SC-III evaluated 339, 638, 389, 1441, 431, 509, 646, and 351 adult patients, respectively.

Clinical response

ACR response

The percent of abatacept-treated patients achieving ACR 20, 50, and 70 responses in study II (patients with inadequate response to methotrexate), study III (patients with inadequate response to TNF-inhibitor), and study VI (methotrexate-naïve patients) are shown in Table 3.

In abatacept-treated patients in studies II and III, statistically significant improvement in the ACR 20 response versus placebo was observed after administration of the first dose (day 15), and this improvement remained significant for the duration of the studies. In study VI, statistically significant improvement in the ACR 20 response in abatacept plus methotrexate-treated patients versus methotrexate plus placebo-treated patients was observed at 29 days, and was maintained through the duration of the study. In study II, 43% of the patients who had not achieved an ACR 20 response at 6 months developed an ACR 20 response at 12 months.

Table 3: Clinical responses in controlled trials

	Percent of patients					
	MTX-Naive		Inadequate response to MTX		Inadequate response to TNF Inhibitor	
	Study VI		Study II		Study III	
Response Rate	Abatacept ^a +MTX n = 256	Placebo +MTX n = 253	Abatacept ^a +MTX n = 424	Placebo +MTX n = 214	Abatacept ^a +DMARDs ^b n = 256	Placebo +DMARDs ^b n = 133
ACR 20						
Day 15	24%	18%	23%*	14%	18%**	5%
Month 3	64% ^{††}	53%	62%***	37%	46%***	18%
Month 6	75% [†]	62%	68%***	40%	50%***	20%
Month 12	76% [‡]	62%	73%***	40%	NA ^d	NA ^d
ACR 50						
Month 3	40% [‡]	23%	32%***	8%	18%**	6%
Month 6	53% [‡]	38%	40%***	17%	20%***	4%
Month 12	57% [‡]	42%	48%***	18%	NA ^d	NA ^d
ACR 70						
Month 3	19% [†]	10%	13%***	3%	6% ^{††}	1%
Month 6	32% [†]	20%	20%***	7%	10%**	2%
Month 12	43% [‡]	27%	29%***	6%	NA ^d	NA ^d
Major Clinical Response^c	27% [‡]	12%	14%***	2%	NA ^d	NA ^d
DAS28-CRP Remission^e						
Month 6	28% [‡]	15%	NA	NA	NA	NA
Month 12	41% [‡]	23%	NA	NA	NA	NA

* p < 0.05, abatacept vs. placebo.

** p < 0.01, abatacept vs. placebo.

*** p < 0.001, abatacept vs. placebo.

† p < 0.01, abatacept plus MTX vs. MTX plus placebo

‡ p < 0.001, abatacept plus MTX vs. MTX plus placebo

†† p < 0.05, abatacept plus MTX vs. MTX plus placebo

^a Fixed dose approximating 10 mg/kg (see section 4.2).^b Concurrent DMARDs included one or more of the following: methotrexate, chloroquine/hydroxychloroquine, sulfasalazine, leflunomide, azathioprine, gold, and anakinra.^c Major clinical response is defined as achieving an ACR 70 response for a continuous 6-month period.^d After 6 months, patients were given the opportunity to enter an open-label study.^e DAS28-CRP Remission is defined as a DAS28-CRP score < 2.6

In the open-label extension of studies I, II, III, and VI durable and sustained ACR 20, 50, and 70 responses have been observed through 7 years, 5 years, 5 years, and 2 years, respectively, of abatacept treatment. In study I, ACR responses were assessed at 7 years in 43 patients with 72% ACR 20 responses, 58% ACR 50 responses, and 44% ACR 70 responses. In study II, ACR responses were assessed at 5 years in 270 patients with 84% ACR 20 responses, 61% ACR 50 responses, and 40% ACR 70 responses. In study III, ACR responses were assessed at 5 years in 91 patients with 74% ACR 20 responses, 51% ACR 50 responses, and 23% ACR 70 responses. In study VI, ACR responses

were assessed at 2 years in 232 patients with 85% ACR 20 responses, 74% ACR 50 responses, and 54% ACR 70 responses.

Greater improvements were seen with abatacept than with placebo in other measures of rheumatoid arthritis disease activity not included in the ACR response criteria, such as morning stiffness.

DAS28 response

Disease activity was also assessed using the Disease Activity Score 28. There was a significant improvement of DAS in studies II, III, V, and VI as compared to placebo or comparator.

In study VI, which only included adults, a significantly higher proportion of patients in the abatacept plus methotrexate group (41%) achieved DAS28 (CRP)-defined remission (score < 2.6) versus the methotrexate plus placebo group (23%) at year 1. The response at year 1 in the abatacept group was maintained through year 2.

In the substudy of study VI, patients who had achieved remission at 2 years (DAS 28 ESR < 2.6) and after at least 1 year of treatment with abatacept in study VI were eligible to enter a substudy. In the substudy 108 subjects were randomised 1:1 in double blinded fashion to receive abatacept at doses approximating 10 mg/kg (ABA 10) or 5 mg/kg (ABA 5). After 1 year of treatment, the maintenance of remission was assessed by the relapse of the disease. The time to and proportion of patients with the relapse of the disease observed between the two groups were similar.

Study V: abatacept or infliximab versus placebo

A randomised, double-blind study was conducted to assess the safety and efficacy of abatacept or infliximab versus placebo in patients with an inadequate response to methotrexate (study V). The primary outcome was the mean change in disease activity in abatacept-treated patients compared to placebo-treated patients at 6 months with a subsequent double-blind assessment of safety and efficacy of abatacept and infliximab at 12 months. Greater improvement ($p < 0.001$) in DAS28 was observed with abatacept and with infliximab compared to placebo at six months in the placebo-controlled portion of the trial; the results between the abatacept and infliximab groups were similar. The ACR responses in study V were consistent with the DAS28 score. Further improvement was observed at 12 months with abatacept. At 6 months, the incidence of AE of infections were 48.1% (75), 52.1% (86), and 51.8% (57) and the incidence of serious AE of infections were 1.3% (2), 4.2% (7), and 2.7% (3) for abatacept, infliximab and placebo groups, respectively. At 12 months, the incidence of AE of infections were 59.6% (93), 68.5% (113), and the incidence of serious AE of infections were 1.9% (3) and 8.5% (14) for abatacept and infliximab groups, respectively. The open label period of the study provided an assessment of the ability of abatacept to maintain efficacy for subjects originally randomised to abatacept and the efficacy response of those subjects who were switched to abatacept following treatment with infliximab. The reduction from baseline in mean DAS28 score at day 365 (-3.06) was maintained through day 729 (-3.34) in those patients who continued with abatacept. In those patients who initially received infliximab and then switched to abatacept, the reduction in the mean DAS28 score from baseline was 3.29 at day 729 and 2.48 at day 365.

Study SC-II: abatacept versus adalimumab

A randomised, single (investigator)-blinded, non-inferiority study was conducted to assess the safety and efficacy of weekly subcutaneous (SC) abatacept without an abatacept intravenous (IV) loading dose versus every-other-weekly subcutaneous adalimumab, both with background MTX, in patients with an inadequate response to methotrexate (study SC-II). The primary endpoint showed non-inferiority (predefined margin of 12%) of ACR 20 response after 12 months of treatment, 64.8% (206/318) for the abatacept SC group and 63.4% (208/328) for the adalimumab SC group; treatment difference was 1.8% [95% confidence interval (CI): -5.6, 9.2], with comparable responses throughout the 24-month period. The respective values for ACR 20 at 24 months were 59.7% (190/318) for the abatacept SC group and 60.1% (197/328) for the adalimumab SC group. The respective values for ACR 50 and ACR 70 at 12 months and 24 months were consistent and similar for abatacept and adalimumab. The adjusted mean changes (standard error; SE) from baseline in DAS28-CRP were -2.35 (SE 0.08) [95% CI: -2.51, -2.19] and -2.33 (SE 0.08) [95% CI: -2.50, -2.17] in the SC abatacept group and the adalimumab group, respectively, at 24 months, with similar changes

over time. At 24 months, 50.6% (127/251) [95% CI: 44.4, 56.8] of patients in abatacept and 53.3% (130/244) [95% CI: 47.0, 59.5] of patients in adalimumab groups achieved DAS 28 < 2.6. Improvement from baseline as measured by HAQ-DI at 24 months and over time was also similar between abatacept SC and adalimumab SC.

Safety and structural damage assessments were conducted at one and two years. The overall safety profile with respect to adverse reactions was similar between the two groups over the 24-month period. After 24 months, adverse reactions were reported in 41.5% (132/318) and 50% (164/328) of abatacept and adalimumab-treated patients. Serious adverse reactions were reported in 3.5% (11/318) and 6.1% (20/328) of the respective group. At 24 months, 20.8% (66/318) of patients on abatacept and 25.3% (83/328) on adalimumab had discontinued.

In SC-II, serious infections were reported in 3.8% (12/318) of patients treated with abatacept SC weekly, none of which led to discontinuation and in 5.8% (19/328) of patients treated with adalimumab SC every-other-week, leading to 9 discontinuations in the 24-month period.

The frequency of local injection site reactions was 3.8% (12/318) and 9.1% (30/328) at 12 months ($p = 0.006$) and 4.1% (13/318) and 10.4% (34/328) at 24 months for abatacept SC and adalimumab SC, respectively. Over the 2 year study period, 3.8% (12/318) and 1.5% (5/328) patients treated with abatacept SC and adalimumab SC respectively reported autoimmune disorders mild to moderate in severity (e.g., psoriasis, Raynaud's phenomenon, erythema nodosum).

Study SC-III: Induction of remission in methotrexate-naive RA patients

A randomised and double-blinded study evaluated abatacept SC in combination with methotrexate (abatacept + MTX), abatacept SC monotherapy, or methotrexate monotherapy (MTX group) in induction of remission following 12 months of treatment, and maintenance of drug-free remission after complete drug withdrawal in MTX-naive adult patients with highly active early rheumatoid arthritis with poor prognostic factors. Complete drug withdrawal led to loss of remission (return to disease activity) in all three treatment arms (abatacept with methotrexate, abatacept or methotrexate alone) in a majority of patients (Table 4).

Table 4: Remission rates at end of drug treatment and drug withdrawal phases in study SC-III

Number of patients	Abatacept SC+ MTX n = 119	MTX n = 116	Abatacept SC n = 116
Proportion of randomised patients with induction of remission after 12 months of treatment			
DAS28-Remission ^a	60.9%	45.2%	42.5%
Odds Ratio (95% CI) vs. MTX	2.01 (1.18, 3.43)	N/A	0.92 (0.55, 1.57)
P value	0.010	N/A	N/A
SDAI Clinical Remission ^b	42.0%	25.0%	29.3%
Estimate of Difference (95% CI) vs. MTX	17.02 (4.30, 29.73)	N/A	4.31 (-7.98, 16.61)
Boolean Clinical Remission	37.0%	22.4%	26.7%
Estimate of Difference (95% CI) vs. MTX	14.56 (2.19, 26.94)	N/A	4.31 (-7.62, 16.24)

Number of patients	Abatacept SC+ MTX n = 119	MTX n = 116	Abatacept SC n = 116
Proportion of randomised patients in remission at 12 months and at 18 months (6 months of complete drug withdrawal)			
DAS28-Remission ^a	14.8%	7.8%	12.4%
Odds Ratio (95% CI) vs. MTX	2.51 (1.02, 6.18)	N/A	2.04 (0.81, 5.14)
P value	0.045	N/A	N/A

^a DAS28-defined remission (DAS28-CRP < 2.6)

^b SDAI criterion (SDAI ≤ 3.3)

In SC-III the safety profiles of the three treatment groups (abatacept + MTX, abatacept monotherapy, MTX group) were overall similar. During the 12-month treatment period, adverse reactions were reported in 44.5% (53/119), 41.4% (48/116), and 44.0% (51/116) and serious adverse reactions were reported in 2.5% (3/119), 2.6% (3/116) and 0.9% (1/116) of patients treated in the three treatment groups, respectively. Serious infections were reported in 0.8% (1/119), 3.4% (4/116) and 0% (0/116) patients.

Radiographic response

Structural joint damage was assessed radiographically over a two-year period in studies II, and VI. The results were measured using the Genant-modified total Sharp score (TSS) and its components, the erosion score and joint space narrowing (JSN) score.

In study II, the baseline median TSS was 31.7 in abatacept-treated patients and 33.4 in placebo-treated patients. Abatacept/methotrexate reduced the rate of progression of structural damage compared to placebo/methotrexate after 12 months of treatment as shown in Table 5. The rate of progression of structural damage in year 2 was significantly lower than that in year 1 for patients randomised to abatacept ($p < 0.0001$). Subjects entering the long term extension after 1 year of double blind treatment all received abatacept treatment and radiographic progression was investigated through year 5. Data were analysed in an as-observed analysis using mean change in total score from the previous annual visit. The mean change was, 0.41 and 0.74 from year 1 to year 2 ($n = 290, 130$), 0.37 and 0.68 from year 2 to year 3 ($n = 293, 130$), 0.34 and 0.43 from year 3 to year 4 ($n = 290, 128$) and the change was 0.26 and 0.29 ($n = 233, 114$) from year 4 to year 5 for patients originally randomised to abatacept plus MTX and placebo plus MTX respectively.

Table 5: Mean radiographic changes over 12 months in study II

Parameter	Abatacept/MTX n = 391	Placebo/MTX n = 195	P-value ^a
Total Sharp score	1.21	2.32	0.012
Erosion score	0.63	1.14	0.029
JSN score	0.58	1.18	0.009

^a Based on non-parametric analysis.

In study VI, the mean change in TSS at 12 months was significantly lower in patients treated with abatacept plus methotrexate compared to those treated with methotrexate plus placebo. At 12 months 61% (148/242) of the patients treated with abatacept plus methotrexate and 53% (128/242) of the patients treated with methotrexate plus placebo had no progression (TSS ≤ 0). The progression of structural damage was lower in patients receiving continuous abatacept plus methotrexate treatment (for 24 months) compared to patients who initially received methotrexate plus placebo (for 12 months) and were switched to abatacept plus methotrexate for the next 12 months. Among the patients who entered the open-label 12-month period, 59% (125/213) of patients receiving continuous abatacept

plus methotrexate treatment and 48% (92/192) of patients who initially received methotrexate and switched to combination with abatacept had no progression.

In study SC-III, structural joint damage was assessed by MRI. The abatacept + MTX group had less progression in structural damage compared with MTX group as reflected by mean treatment difference of the abatacept + MTX group versus MTX group (Table 6).

Table 6: Structural and inflammatory MRI assessment in study SC-III

Mean Treatment Difference between Abatacept SC+MTX vs. MTX at 12 Months (95% CI)*

MRI Erosion Score	-1.22 (-2.20, -0.25)
MRI Osteitis/Bone Oedema Score	-1.43 (-2.68, -0.18)
MRI Synovitis Score	-1.60 (-2.42, -0.78)

* n = 119 for Abatacept SC + MTX; n = 116 for MTX

Physical function response

Improvement in physical function was measured by the Health Assessment Questionnaire Disability Index (HAQ-DI) in studies II, III, IV, V, and VI and the modified HAQ-DI in study I. The results from studies II, III, and VI are shown in Table 7.

Table 7: Improvement in physical function in controlled trials

	Methotrexate-Naive		Inadequate response to Methotrexate		Inadequate response to TNF Inhibitor	
	Study VI		Study II		Study III	
	Abatacept ^a +MTX	Placebo +MTX	Abatacept ^a +MTX	Placebo +MTX	Abatacept ^a +DMARDs ^b	Placebo +DMARDs ^b
HAQ ^c Disability Index						
Baseline (Mean)	1.7 (n = 254)	1.7 (n = 251)	1.69 (n = 422)	1.69 (n = 212)	1.83 (n = 249)	1.82 (n = 130)
Mean Improvement from Baseline						
Month 6	0.85 (n = 250)	0.68 (n = 249)	0.59*** (n = 420)	0.40 (n = 211)	0.45*** (n = 249)	0.11 (n = 130)
Month 12	0.96 (n = 254)	0.76 (n = 251)	0.66*** (n = 422)	0.37 (n = 212)	NA ^e	NA ^e
Proportion of patients with a clinically meaningful improvement ^d						
Month 6	72% [†]	63%	61%***	45%	47%***	23%
Month 12	72% [†]	62%	64%***	39%	NA ^e	NA ^e

*** p < 0.001, abatacept vs. placebo.

† p < 0.05, abatacept plus MTX vs MTX plus placebo

^a Fixed dose approximating 10 mg/kg (see section 4.2).

^b Concurrent DMARDs included one or more of the following: methotrexate, chloroquine/hydroxychloroquine, sulfasalazine, leflunomide, azathioprine, gold, and anakinra.

^c Health Assessment Questionnaire; 0 = best, 3 = worst; 20 questions; 8 categories: dressing and grooming, arising, eating, walking, hygiene, reach, grip, and activities.

^d Reduction in HAQ-DI of ≥ 0.3 units from baseline.

^e After 6 months, patients were given the opportunity to enter into an open-label study.

In study II, among patients with clinically meaningful improvement at month 12, 88% retained the response at month 18, and 85% retained the response at month 24. During the open-label periods of studies I, II, III, and VI the improvement in physical function has been maintained through 7 years, 5 years, 5 years, and 2 years, respectively.

In study SC-III, the proportion of subjects with a HAQ response as a measure of clinically meaningful improvement in physical function (reduction from baseline in HAQ-DI score of ≥ 0.3) was greater for the abatacept + MTX group vs. the MTX group at month 12 (65.5% vs 44.0%, respectively; treatment difference vs. MTX group of 21.6% [95% CI: 8.3, 34.9]).

Health-related outcomes and quality of life

Health-related quality of life was assessed by the SF-36 questionnaire at 6 months in studies I, II, and III and at 12 months in studies I and II. In these studies, clinically and statistically significant improvement was observed in the abatacept group as compared with the placebo group in all 8 domains of the SF-36 (4 physical domains: physical function, role physical, bodily pain, general health; and 4 mental domains: vitality, social function, role emotional, mental health), as well as the Physical Component Summary (PCS) and the Mental Component Summary (MCS). In study VI, improvement was observed at 12 months in abatacept plus methotrexate group as compared with the methotrexate plus placebo group in both PCS and MCS, and was maintained through 2 years.

Study VII: Safety of abatacept in patients with or without washout of previous TNF-inhibitor therapy

A study of open-label abatacept on a background of nonbiologic DMARDs was conducted in patients with active RA who had an inadequate response to previous (washout for at least 2 months; n = 449) or current (no washout period; n = 597) TNF-inhibitor therapy (study VII). The primary outcome, incidence of AEs, SAEs, and discontinuations due to AEs during 6 months of treatment, was similar between those who were previous and current TNF-inhibitor users at enrollment, as was the frequency of serious infections.

Clinical efficacy and safety in adult psoriatic arthritis

The efficacy and safety of abatacept were assessed in two randomised, double-blind, placebo-controlled trials (studies PsA-I and PsA-II) in adult patients, age 18 years and older. Patients had active PsA (≥ 3 swollen joints and ≥ 3 tender joints) despite prior treatment with DMARD therapy and had one qualifying psoriatic skin lesion of at least 2 cm in diameter.

In study PsA-I, 170 patients received placebo or abatacept intravenously on day 1, 15, 29, and then every 28 days thereafter in a double blind manner for 24 weeks, followed by open-label abatacept 10 mg/kg intravenously every 28 days. Patients were randomised to receive placebo or abatacept 3 mg/kg, 10 mg/kg, or two doses of 30 mg/kg followed by 10 mg/kg, without escape for 24 weeks, followed by open label abatacept 10 mg/kg monthly intravenous every month. Patients were allowed to receive stable doses of concomitant methotrexate, low dose corticosteroids (equivalent to ≤ 10 mg of prednisone) and/or NSAIDs during the trial.

In study PsA-II, 424 patients were randomised 1:1 to receive in a double-blind manner weekly doses of subcutaneous placebo or abatacept 125 mg without a loading dose for 24 weeks, followed by open-label abatacept 125 mg subcutaneous weekly. Patients were allowed to receive stable doses of concomitant methotrexate, sulfasalazine, leflunomide, hydroxychloroquine, low dose corticosteroids (equivalent to ≤ 10 mg of prednisone) and/or NSAIDs during the trial. Patients who had not achieved at least a 20% improvement from baseline in their swollen and tender joint counts by week 16 escaped to open-label abatacept 125 mg subcutaneous weekly.

The primary endpoint for both PsA-I and PsA-II was the proportion of patients achieving ACR 20 response at Week 24 (day 169).

Clinical Response

Signs and symptoms

The percent of patients achieving ACR 20, 50, or 70 responses at the recommended abatacept dose in studies PsA-I (10 mg/kg intravenous) and PsA-II (125 mg subcutaneous) are presented in Table 8 below.

Table 8: Proportion of patients with ACR responses at week 24 in studies PsA-I and PsA-II

	PsA-I ^a			PsA-II ^{b,c}		
	Abatacept 10 mg/kg IV N = 40	Placebo N = 42	Estimate of difference (95% CI)	Abatacept 125 mg SC N = 213	Placebo N = 211	Estimate of difference (95% CI)
ACR 20	47.5%*	19.0%	28.7 (9.4, 48.0)	39.4%*	22.3%	17.2 (8.7, 25.6)
ACR 50	25.0%	2.4%	22.7 (8.6, 36.9)	19.2%	12.3%	6.9 (0.1, 13.7)
ACR 70	12.5%	0%	12.5 (2.3, 22.7)	10.3%	6.6%	3.7 (-1.5, 8.9)

* p < 0.05 vs placebo, p values not assessed for ACR 50 and ACR 70.

^a 37% of patients were previously treated with TNF inhibitor.

^b 61% of patients were previously treated with TNF inhibitor.

^c Patients who had less than 20% improvement in tender or swollen joint counts at Week 16 met escape criteria and were considered non-responders.

A significantly higher proportion of patients achieved an ACR 20 response after treatment with abatacept 10 mg/kg intravenous in PsA-I or 125 mg subcutaneous in PsA-II compared to placebo at Week 24 in the overall study populations. Higher ACR 20 responses were observed with abatacept vs placebo regardless of prior TNF-inhibitor treatment in both studies. In the smaller study PsA-I, the ACR 20 responses with abatacept 10 mg/kg intravenous vs placebo in patients who were TNF inhibitor-naïve were 55.6% vs 20.0%, respectively, and in patients who were TNF inhibitor-experienced were 30.8% vs 16.7%, respectively. In study PsA-II, the ACR 20 responses with abatacept 125 mg subcutaneous vs placebo in patients who were TNF inhibitor-naïve were 44.0% vs 22.2%, respectively (21.9 [8.3, 35.6], estimate of difference [95% CI]), and in patients who were TNF inhibitor-experienced were 36.4% vs 22.3%, respectively (14.0 [3.3, 24.8], estimate of difference [95% CI]).

Higher ACR 20 responses in study PsA-II were seen with abatacept 125 mg subcutaneous vs. placebo irrespective of concomitant nonbiological DMARD treatment. The ACR 20 responses with abatacept 125 mg subcutaneous vs placebo in patients who did not use nonbiological DMARDs were 27.3% vs 12.1%, respectively, (15.15 [1.83, 28.47], estimate of difference [95% CI]), and in patients who had used non-biological DMARDs were 44.9% vs 26.9%, respectively, (18.00 [7.20, 28.81], estimate of difference [95% CI]). Clinical responses were maintained or continued to improve up to one year in studies PsA-I and PsA-II.

Structural response

In study PsA-II, the proportion of radiographic non-progressors (≤ 0 change from baseline) in total PsA-modified SHS on x-rays at Week 24 was greater with abatacept 125 mg subcutaneous (42.7%) than placebo (32.7%) (10.0 [1.0, 19.1] estimate of difference [95% CI]).

Physical Function Response

In study PsA-I, the proportion of patients with ≥ 0.30 decrease from baseline in HAQ-DI score was 45.0% with intravenous abatacept vs 19.0% with placebo (26.1 [6.8, 45.5], estimate of difference [95% CI]) at Week 24. In study PsA-II, the proportion of patients with at least ≥ 0.35 decrease from baseline in HAQ-DI was 31.0% with abatacept vs. 23.7% with placebo (7.2 [-1.1, 15.6], estimate of difference [95% CI]). Improvement in HAQ-DI scores was maintained or improved for up to 1 year with continuing abatacept treatment in both PsA-I and PsA-II studies.

No significant changes in PASI scores with abatacept treatment were seen over the 24-week double-blind period. Patients entering the two PsA studies had mild to moderate psoriasis with median PASI scores of 8.6 in PsA-I and 4.5 in PsA-II. In study PsA-I, the proportions of patients achieving PASI 50 response was 28.6% with abatacept vs. 14.3% with placebo (14.3 [-15.3, 43.9], estimate of difference [95% CI]), and the proportion of patients who achieved PASI 75 response was 14.3% with abatacept vs. 4.8% with placebo (9.5 [-13.0, 32.0], estimate of difference [95% CI]). In study PsA-II, the proportion of patients who achieved PASI 50 response was 26.7% with abatacept vs. 19.6% with placebo (7.3 [-2.2, 16.7], estimate of difference [95% CI]), and the proportion of patients who achieved PASI 75 response was 16.4% with abatacept vs. 10.1% with placebo (6.4 [-1.3, 14.1], estimate of difference [95% CI]).

Paediatric population in polyarticular juvenile idiopathic arthritis

Children and adolescents with moderate to severe active pJIA, ages 6 to 17 years with an inadequate response or intolerance to at least one DMARD, which may have included biologic agents, were enrolled. The safety and efficacy of intravenous abatacept were assessed in a three-part study. Period A was a 4-month open-label lead-in designed to induce an ACR Pedi 30 response. Patients achieving at least a ACR Pedi 30 response at the end of Period A were randomised into a double-blind, withdrawal phase (Period B), and received either abatacept or placebo for 6 months or until pJIA disease flare as defined in the study. Unless they had discontinued due to safety reasons, all patients who completed, or had a flare during Period B or were non-responders in Period A were offered entry into Period C, the open-label extension, which assessed long-term safety and efficacy.

In Period A all patients received 10 mg/kg of abatacept on days 1, 15, 29, 57 and 85 and were assessed on day 113. During period A, 74% were taking methotrexate (mean dose at study entry, 13.2 mg/m²/week) thus, 26% of patients received abatacept monotherapy in Period A. Of the 190 patients entering the study, 57 (30%) had previously been treated with TNF-inhibitor therapy.

ACR Pedi 30 responders at the end of Period A were randomised into Period B, the double-blind, withdrawal phase, to receive either abatacept or placebo for 6 months or until JIA flare.

Flare was defined as:

- $\geq 30\%$ worsening in at least 3 of the 6 pJIA core set variables
- $\geq 30\%$ improvement in not more than 1 of the 6 pJIA core set variables
- ≥ 2 cm (possible up to 10 cm) of worsening must have been present if the Physician or Parent Global Assessment was used to define flare
- worsening in ≥ 2 joints must have been present if the number of active joints or joints with limited range of motion was used to define flare

The patients entered in the trial were a mean of 12.4 years of age with mean disease duration of 4.4 years. They had active disease, with baseline mean active joint count of 16 and a mean number of joints with loss of motion of 16; and elevated C-reactive protein (CRP) levels (mean, 3.2 mg/dL) and ESRs (mean, 32 mm/h). Their pJIA subtypes at disease onset were: oligoarticular (16%), polyarticular (64%; 20% of the total were rheumatoid factor positive), and systemic (20%).

Of the 190 patients enrolled, 170 completed Period A, 65% (123/190) achieved an ACR Pedi 30 response, and 122 were randomised to Period B. Responses were similar in all subtypes of pJIA studied and for patients with or without methotrexate use. Of the 133 (70%) patients with no prior

TNF-inhibitor therapy, 101 (76%) achieved at least an ACR Pedi 30 response; of the 57 patients who had received prior TNF-inhibitor therapy, 22 (39%) achieved at least an ACR Pedi 30 response.

During Period B, the time to disease flare for the patients randomised to placebo was significantly shorter than for those randomised to abatacept (primary endpoint, $p = 0.0002$; log-rank test). Significantly more placebo recipients flared during Period B (33/62; 53%) than those maintained on abatacept (12/60; 20%; chi-square $p < 0.001$). The risk of disease flare for patients continuing on abatacept was less than one third that for placebo-treated patients (hazard ratio estimate = 0.31; 95% CI 0.16, 0.59).

Most randomised Period B patients entered Period C (58/60 Period B abatacept recipients; 59/62 Period B placebo recipients), as did 36 of the 47 Period A non-responders ($n = 153$ total patients).

Response rates at the end of Period A, at the end of Period B and after 5 years exposure in Period C are summarised in Table 9:

Table 9: Proportion (%) of polyarticular JIA patients with ACR responses or inactive disease

	End of Period A (day 113)	End of Period B ^a (day 169)		Period C ^b (day 1765)		
	Abatacept n = 190	Abatacept n = 58	Placebo n = 59	Abatacept group in Period B n = 33	Placebo group in Period B n = 30	Non-responder in Period A n = 13
ACR30	65	85	68	97	87	69
ACR50	50	79	53	94	80	69
ACR70	28	55	31	79	63	54
ACR90	13	41	15	67	40	39
Inactive disease	Not assessed	31	10	52	33	31

^a day 169 Last Observation Carried Forward (LOCF) for patients treated in Period C

^b As observed

Participants in Period C at day 1765 included 33 of the 58 Period B abatacept recipients, 30 of the 59 Period B placebo recipients, and 13 of the 36 Period A non-responders. The median duration of abatacept treatment in Period C was 1815 days (range 57–2,415 days; nearly 61 months). One hundred and two (67%) of the subjects had received at least 1,080 days (~ 36 months) of abatacept therapy in Period C. All patients had at least 4 months of prior, open-label abatacept treatment in Period A.

Abatacept in pJIA patients has also been studied with the subcutaneous formulation in children and adolescents with moderate to severe active pJIA, ages 2 to 17 years with an inadequate response or intolerance to at least one DMARD, which may have included biologic agents. The safety and efficacy of abatacept in the ongoing SC study were consistent with the results seen with abatacept in the IV study (see section 5.1 of the ORENCIA solution for injection in pre-filled syringe SmPC for complete study description and results).

5.2 Pharmacokinetic properties

Adult rheumatoid arthritis

After multiple intravenous infusions (days 1, 15, 30, and every 4 weeks thereafter), the pharmacokinetics of abatacept in rheumatoid arthritis patients showed dose-proportional increases of C_{max} and AUC over the dose range of 2 mg/kg to 10 mg/kg. At 10 mg/kg, the mean terminal half-life was 13.1 days, ranging from 8 to 25 days. The mean distribution volume (V_{ss}) was 0.07 L/kg and

ranged from 0.02 to 0.13 L/kg. The systemic clearance was approximately 0.22 mL/h/kg. Mean steady-state trough concentrations were approximately 25 mcg/mL, and mean C_{max} concentrations were approximately 290 mcg/mL. No systemic accumulation of abatacept occurred upon continued repeated treatment with 10 mg/kg at monthly intervals in rheumatoid arthritis patients.

Population pharmacokinetic analyses revealed that there was a trend toward higher clearance of abatacept with increasing body weight. Age and gender (when corrected for body weight) did not affect clearance. Methotrexate, NSAIDs, corticosteroids, and TNF-inhibitors were not found to influence abatacept clearance. No studies were conducted to examine the effects of either renal or hepatic impairment on the pharmacokinetics of abatacept.

Adult psoriatic arthritis

In PsA-I, patients were randomised to receive intravenous placebo or abatacept 3 mg/kg (3/3 mg/kg), 10 mg/kg (10/10 mg/kg), or two doses of 30 mg/kg followed by 10 mg/kg (30/10 mg/kg), on day 1, 15, 29, and then every 28 days thereafter. In this study, the steady-state concentrations of abatacept were dose-related. The geometric mean (CV%) c_{min} at day 169 were 7.8 mcg/mL (56.3%) for the 3/3 mg/kg, 24.3 mcg/mL (40.8%) for 10/10 mg/kg, and 26.6 mcg/mL (39.0%) for the 30/10 mg/kg regimens.

In study PsA-II following weekly subcutaneous administration of abatacept at 125 mg, steady-state of abatacept was reached at day 57 with the geometric mean (CV%) c_{min} ranging from 22.3 (54.2%) to 25.6 (47.7%) mcg/mL on days 57 to 169, respectively.

Consistent with the results observed earlier in RA patients, population pharmacokinetic analyses for abatacept in PsA patients revealed that there was a trend toward higher clearance (L/h) of abatacept with increasing body weight.

Paediatric population

Population pharmacokinetic analysis of abatacept serum concentration data from patients with pJIA 6 to 17 years of age following administration of intravenous abatacept 10 mg/kg revealed that the estimated clearance of abatacept, when normalised for baseline body weight, was higher in pJIA patients (0.4 mL/h/kg for a child weighing 40 kg) versus adult rheumatoid arthritis patients. Typical estimates for distribution volume and elimination half-life were 0.12 L/kg and 11.4 days, respectively, for a child weighing 40 kg. As a result of the higher body-weight normalised clearance and volume of distribution in pJIA patients, the predicted and observed systemic exposures of abatacept were lower than that observed in adults, such that the observed mean (range) peak and trough concentrations were 204 (66 to 595) mcg/mL and 10.6 (0.15 to 44.2) mcg/mL, respectively, in patients weighing less than 40 kg, and 229 (58 to 700) mcg/mL and 13.1 (0.34 to 44.6) mcg/mL, respectively, in patients weighing 40 kg or greater.

5.3 Preclinical safety data

No mutagenicity or clastogenicity was observed with abatacept in a battery of *in vitro* studies. In a mouse carcinogenicity study, increases in the incidence of malignant lymphomas and mammary gland tumours (in females) occurred. The increased incidence of lymphomas and mammary tumours observed in mice treated with abatacept may have been associated with decreased control of murine leukaemia virus and mouse mammary tumour virus, respectively, in the presence of long-term immunomodulation. In a one-year toxicity study in cynomolgus monkeys, abatacept was not associated with any significant toxicity. Reversible pharmacological effects consisted of minimal transient decreases in serum IgG and minimal to severe lymphoid depletion of germinal centres in the spleen and/or lymph nodes. No evidence of lymphomas or preneoplastic morphological changes was observed, despite the presence of a virus, lymphocryptovirus, which is known to cause such lesions in immunosuppressed monkeys within the time frame of this study. The relevance of these findings to the clinical use of abatacept is unknown.

In rats, abatacept had no undesirable effects on male or female fertility. Embryo-foetal development studies were conducted with abatacept in mice, rats, and rabbits at doses up to 20 to 30 times a human 10 mg/kg dose and no undesirable effects were observed in the offspring. In rats and rabbits, abatacept exposure was up to 29-fold a human 10 mg/kg exposure based on AUC. Abatacept was shown to cross the placenta in rats and rabbits. In a pre- and postnatal development study with abatacept in rats, no undesirable effects were observed in pups of dams given abatacept at doses up to 45 mg/kg, representing 3-fold a human 10 mg/kg exposure based on AUC. At a dose of 200 mg/kg, representing 11-fold a human exposure at 10 mg/kg based on AUC, limited changes in immune function (a 9-fold increase in the mean T-cell-dependent antibody response in female pups and inflammation of the thyroid of 1 female pup out of 10 male and 10 female pups evaluated at this dose) were observed.

Non-clinical studies relevant for use in the paediatric population

Studies in rats exposed to abatacept have shown immune system abnormalities including a low incidence of infections leading to death (juvenile rats). In addition, inflammation of the thyroid and pancreas was frequently seen in both juvenile and adult rats exposed to abatacept. Juvenile rats seemed to be more sensitive to lymphocytic inflammation of thyroid. Studies in adult mice and monkeys have not demonstrated similar findings. It is likely that the increased susceptibility to opportunistic infections observed in juvenile rats is associated with the exposure to abatacept before development of memory responses. The relevance of these results to humans is unknown.

6. PHARMACEUTICAL PARTICULARS

6.1 List of excipients

Maltose
Sodium dihydrogen phosphate monohydrate
Sodium chloride

6.2 Incompatibilities

In the absence of compatibility studies, this medicinal product must not be mixed with other medicinal products. ORENCIA should not be infused concomitantly in the same intravenous line with other medicinal products.

ORENCIA should NOT be used with siliconised syringes (see section 6.6).

6.3 Shelf life

Unopened vial

3 years

After reconstitution

Chemical and physical in-use stability has been demonstrated for 24 hours at 2°C - 8°C. From a microbiological point of view, the reconstituted solution should be diluted immediately.

After dilution

When the reconstituted solution is diluted immediately, the chemical and physical in-use stability of the diluted infusion solution has been demonstrated for 24 hours at 2°C - 8°C. From a microbiological point of view, the product should be used immediately.

6.4 Special precautions for storage

Store in a refrigerator (2°C - 8°C).

Store in the original package in order to protect from light.

For storage conditions after reconstitution and dilution of the medicinal product, see section 6.3.

6.5 Nature and contents of container

Vial (15 mL Type 1 glass) with a stopper (halobutyl-rubber) and flip off seal (aluminium).

Pack of 1 vial and 1 silicone-free syringe (polyethylene), and multipacks containing 2, or 3 vials and 2, or 3 silicone-free syringes (2 or 3 packs of 1).

Not all pack-sizes may be marketed.

6.6 Special precautions for disposal and other handling

Reconstitution and dilution should be performed in accordance with good practices rules, particularly with respect to asepsis.

Reconstitution

1. Determine the dose and the number of ORENCIA vials needed (see section 4.2).
2. Under aseptic conditions, reconstitute each vial with 10 mL of water for injections, using the **silicone-free disposable syringe provided with each vial** (see section 6.2) and an 18-21 gauge needle.
 - Remove the flip-top from the vial and wipe the top with an alcohol swab.
 - Insert the syringe needle into the vial through the centre of the rubber stopper and direct the stream of water for injections to the glass wall of the vial.
 - Do not use the vial if the vacuum is not present.
 - Remove the syringe and needle after 10 mL of water for injections have been injected into the vial.
 - To minimise foam formation in solutions of ORENCIA, the vial should be rotated with gentle swirling until the contents are completely dissolved. **Do not shake**. Avoid prolonged or vigorous agitation.
 - Upon complete dissolution of the powder, the vial should be vented with a needle to dissipate any foam that may be present.
 - After reconstitution the solution should be clear and colourless to pale yellow. Do not use if opaque particles, discolouration, or other foreign particles are present.

Dilution

3. Immediately after reconstitution, the concentrate must be further diluted to 100 mL with sodium chloride 9 mg/mL (0.9%) solution for injection.
 - From a 100 mL infusion bag or bottle, withdraw a volume of sodium chloride 9 mg/mL (0.9%) solution for injection equal to the volume of the reconstituted vials.
 - Slowly add the reconstituted ORENCIA solution from each vial to the infusion bag or bottle using the same **silicone-free disposable syringe provided with each vial**.
 - Gently mix. The final concentration of abatacept in the bag or bottle will depend upon the amount of active substance added, but will be no more than 10 mg/mL.
 - Any unused portion in the vials must be immediately discarded in accordance with local requirements.

4. When reconstitution and dilution are performed under aseptic conditions ORENCIA infusion solution can be used immediately or within 24 hours if stored refrigerated at 2°C to 8°C. Prior to administration, the ORENCIA solution should be inspected visually for particulate matter and discolouration. Discard the solution if any particulate matter or discolouration is observed.
 - Do not store any unused portion of the infusion solution for reuse.

Any unused medicinal product or waste material should be disposed of in accordance with local requirements.

7. MARKETING AUTHORISATION HOLDER

Bristol-Myers Squibb Pharma EEIG
Plaza 254
Blanchardstown Corporate Park 2
Dublin 15, D15 T867
Ireland

8. MARKETING AUTHORISATION NUMBERS

EU/1/07/389/001-003

9. DATE OF FIRST AUTHORISATION/RENEWAL OF THE AUTHORISATION

Date of first authorisation: 21 May 2007
Date of latest renewal: 21 May 2012

10. DATE OF REVISION OF THE TEXT

Detailed information on this medicinal product is available on the website of the European Medicines Agency <http://www.ema.europa.eu>.

1. NAME OF THE MEDICINAL PRODUCT

ORENCIA 50 mg solution for injection in pre-filled syringe
ORENCIA 87.5 mg solution for injection in pre-filled syringe
ORENCIA 125 mg solution for injection in pre-filled syringe

2. QUALITATIVE AND QUANTITATIVE COMPOSITION

ORENCIA 50 mg solution for injection in pre-filled syringe

Each pre-filled syringe contains 50 mg of abatacept in 0.4 mL.

ORENCIA 87.5 mg solution for injection in pre-filled syringe

Each pre-filled syringe contains 87.5 mg of abatacept in 0.7 mL.

ORENCIA 125 mg solution for injection in pre-filled syringe

Each pre-filled syringe contains 125 mg of abatacept in one mL.

Abatacept is a fusion protein produced by recombinant DNA technology in Chinese hamster ovary cells.

For the full list of excipients, see section 6.1.

3. PHARMACEUTICAL FORM

Solution for injection (injection).

The solution is clear, colourless to pale yellow with a pH of 6.8 to 7.4.

4. CLINICAL PARTICULARS

4.1 Therapeutic indications

Rheumatoid arthritis

ORENCIA, in combination with methotrexate, is indicated for:

- the treatment of moderate to severe active rheumatoid arthritis (RA) in adult patients who responded inadequately to previous therapy with one or more disease-modifying anti-rheumatic drugs (DMARDs) including methotrexate (MTX) or a tumour necrosis factor (TNF)-alpha inhibitor.
- the treatment of highly active and progressive disease in adult patients with rheumatoid arthritis not previously treated with methotrexate.

A reduction in the progression of joint damage and improvement of physical function have been demonstrated during combination treatment with abatacept and methotrexate.

Psoriatic arthritis

ORENCIA, alone or in combination with methotrexate (MTX), is indicated for the treatment of active psoriatic arthritis (PsA) in adult patients when the response to previous DMARD therapy including MTX has been inadequate, and for whom additional systemic therapy for psoriatic skin lesions is not required.

Polyarticular juvenile idiopathic arthritis

ORENCIA in combination with methotrexate is indicated for the treatment of moderate to severe active polyarticular juvenile idiopathic arthritis (pJIA) in paediatric patients 2 years of age and older who have had an inadequate response to previous DMARD therapy.

ORENCIA can be given as monotherapy in case of intolerance to methotrexate or when treatment with methotrexate is inappropriate.

4.2 Posology and method of administration

Treatment should be initiated and supervised by specialist physicians experienced in the diagnosis and treatment of rheumatoid arthritis.

If a response to abatacept is not present within 6 months of treatment, the continuation of the treatment should be reconsidered (see section 5.1).

Posology

Rheumatoid arthritis

Adults

ORENCIA subcutaneous (SC) may be initiated with or without an intravenous (IV) loading dose. ORENCIA SC should be administered weekly at a dose of 125 mg abatacept by subcutaneous injection regardless of weight (see section 5.1). If a single IV infusion is given to initiate treatment (IV loading dose before SC administration), the first 125 mg abatacept SC should be administered within a day of the IV infusion, followed by the weekly 125 mg abatacept SC injections (for the posology of the intravenous loading dose, please refer to section 4.2 of ORENCIA 250 mg powder for concentrate for solution for infusion).

Patients switching from abatacept intravenous therapy to subcutaneous administration should administer the first subcutaneous dose instead of the next scheduled intravenous dose.

No dose adjustment is required when used in combination with other DMARDs, corticosteroids, salicylates, nonsteroidal anti-inflammatory drugs (NSAIDs), or analgesics.

Psoriatic arthritis

Adults

ORENCIA should be administered weekly at a dose of 125 mg by subcutaneous (SC) injection without the need for an intravenous (IV) loading dose.

Patients switching from ORENCIA intravenous therapy to subcutaneous administration should administer the first subcutaneous dose instead of the next scheduled intravenous dose.

Paediatric population

Polyarticular juvenile idiopathic arthritis

The recommended weekly dose of ORENCIA solution for injection in pre-filled syringe for patients 2 to 17 years of age with polyarticular juvenile idiopathic arthritis should be initiated without an intravenous loading dose and administered utilizing the weight range-based dosing as specified in the table below:

Table 1: Weekly dose of ORENCIA

Body weight of patient	Dose
10 kg to less than 25 kg	50 mg
25 kg to less than 50 kg	87.5 mg
50 kg or more	125 mg

Patients switching from abatacept intravenous therapy to subcutaneous administration should administer the first subcutaneous dose instead of the next scheduled intravenous dose.

ORENCIA powder for concentrate for solution for infusion for intravenous administration is available for paediatric patients 6 years of age and older for the treatment of pJIA (see Summary of Product Characteristics for ORENCIA powder for concentrate for solution for infusion).

Missed dose

If a patient misses an injection of abatacept and is within three days of the planned date, he/she should be instructed to take the missed dose immediately and remain on the original weekly schedule. If the dose is missed by more than three days, the patient should be instructed when to take the next dose based on medical judgment (condition of the patient, status of disease activity, etc).

Special populations

Elderly patients

No dose adjustment is required (see section 4.4).

Renal and hepatic impairment

ORENCIA has not been studied in these patient populations. No dose recommendations can be made.

Paediatric population

The safety and efficacy of ORENCIA in children below 2 years of age have not been established. No data are available.

There is no relevant use of ORENCIA in children under two years old.

Method of administration

For subcutaneous use.

ORENCIA is intended for use under the guidance of a healthcare professional. After proper training in subcutaneous injection technique, a patient or caregiver may inject with ORENCIA if a physician/healthcare professional determines that it is appropriate.

The total content of the pre-filled syringe should be administered as a subcutaneous injection only. Injection sites should be rotated and injections should never be given into areas where the skin is tender, bruised, red, or hard.

Comprehensive instructions for the preparation and administration of ORENCIA in a pre-filled syringe are given in the package leaflet and “Important instructions for use”.

4.3 Contraindications

Hypersensitivity to the active substance or to any of the excipients listed in section 6.1.

Severe and uncontrolled infections such as sepsis and opportunistic infections (see section 4.4).

4.4 Special warnings and precautions for use

Combination with TNF-inhibitors

There is limited experience with use of abatacept in combination with TNF-inhibitors (see section 5.1). In placebo-controlled clinical trials, in comparison with patients treated with TNF-inhibitors and placebo, patients who received combination TNF-inhibitors with abatacept experienced an increase in overall infections and serious infections (see section 4.5). Abatacept is not recommended for use in combination with TNF-inhibitors.

While transitioning from TNF-inhibitor therapy to ORENCIA therapy, patients should be monitored for signs of infection (see section 5.1, study VII).

Allergic reactions

Allergic reactions have been reported uncommonly with abatacept administration in clinical trials, where patients were not required to be pretreated to prevent allergic reactions (see section 4.8). Anaphylaxis or anaphylactoid reactions can occur after the first infusion and can be life-threatening. In postmarketing experience, a case of fatal anaphylaxis following the first infusion of ORENCIA has been reported. If any serious allergic or anaphylactic reaction occurs, intravenous or subcutaneous ORENCIA therapy should be discontinued immediately and appropriate therapy initiated, and the use of ORENCIA should be permanently discontinued (see section 4.8).

Effects on the immune system

Medicinal products which affect the immune system, including ORENCIA, may affect host defences against infections and malignancies, and affect vaccination responses.

Co-administration of ORENCIA with biologic immunosuppressive or immunomodulatory agents could potentiate the effects of abatacept on the immune system (see section 4.5).

Infections

Serious infections, including sepsis and pneumonia, have been reported with abatacept (see section 4.8). Some of these infections have been fatal. Many of the serious infections have occurred in patients on concomitant immunosuppressive therapy which in addition to their underlying disease, could further predispose them to infections. Treatment with ORENCIA should not be initiated in patients with active infections until infections are controlled. Physicians should exercise caution when considering the use of ORENCIA in patients with a history of recurrent infections or underlying conditions which may predispose them to infections. Patients who develop a new infection while undergoing treatment with ORENCIA should be monitored closely. Administration of ORENCIA should be discontinued if a patient develops a serious infection.

No increase of tuberculosis was observed in the pivotal placebo-controlled studies; however, all ORENCIA patients were screened for tuberculosis. The safety of ORENCIA in individuals with latent tuberculosis is unknown. There have been reports of tuberculosis in patients receiving ORENCIA (see section 4.8). Patients should be screened for latent tuberculosis prior to initiating ORENCIA. The available medical guidelines should also be taken into account.

Anti-rheumatic therapies have been associated with hepatitis B reactivation. Therefore, screening for viral hepatitis should be performed in accordance with published guidelines before starting therapy with ORENCIA.

Progressive multifocal leukoencephalopathy (PML)

Cases of PML have been reported in patients receiving abatacept mostly in combination with other immunosuppressive medication. PML can be fatal and should be considered in the differential diagnosis in immunosuppressed patients with new onset or worsening neurological, psychiatric and

cognitive symptoms. If symptoms suggestive of PML occur during ORENCIA therapy, treatment with ORENCIA should be discontinued and appropriate diagnostic measures initiated.

Malignancies

In the placebo-controlled clinical trials, the frequencies of malignancies in abatacept- and placebo-treated patients were 1.2% and 0.9%, respectively (see section 4.8). Patients with known malignancies were not included in these clinical trials. In carcinogenicity studies in mice, an increase in lymphomas and mammary tumours were noted. The clinical significance of this observation is unknown (see section 5.3). The potential role of abatacept in the development of malignancies, including lymphoma, in humans is unknown. There have been reports of non-melanoma skin cancers in patients receiving ORENCIA (see section 4.8). Periodic skin examination is recommended for all patients, particularly those with risk factors for skin cancer.

Vaccinations

Patients treated with ORENCIA may receive concurrent vaccinations, except for live vaccines. Live vaccines should not be given concurrently with abatacept or within 3 months of its discontinuation. Medicinal products that affect the immune system, including abatacept, may blunt the effectiveness of some immunisations (see section 4.5).

Elderly patients

A total of 404 patients 65 years of age and older, including 67 patients 75 years and older, received intravenous abatacept in placebo-controlled clinical trials. A total of 270 patients 65 years of age and older, including 46 patients 75 years and older, received subcutaneous abatacept in controlled clinical trials. The frequencies of serious infection and malignancy relative to placebo among intravenous abatacept-treated patients over age 65 were higher than among those under age 65. Similarly, the frequencies of serious infection and malignancy among subcutaneous abatacept-treated patients over age 65 were higher than among those under age 65. Because there is a higher incidence of infections and malignancies in the elderly in general, caution should be used when treating the elderly (see section 4.8).

Autoimmune processes

There is a theoretical concern that treatment with abatacept might increase the risk for autoimmune processes in adults, for example deterioration of multiple sclerosis. In the placebo-controlled clinical trials, abatacept treatment did not lead to increased autoantibody formation, such as antinuclear and anti-dsDNA antibodies, relative to placebo treatment (see sections 4.8 and 5.3).

Patients on controlled sodium diet

This medicinal product contains less than 1 mmol sodium (23 mg) per pre-filled syringe, that is to say essentially 'sodium-free'.

Traceability

In order to improve the traceability of biological medicinal products, the name and the batch number of the administered product should be clearly recorded.

4.5 Interaction with other medicinal products and other forms of interaction

Combination with TNF-inhibitors

There is limited experience with the use of abatacept in combination with TNF-inhibitors (see section 5.1). While TNF-inhibitors did not influence abatacept clearance, in placebo-controlled clinical trials, patients receiving concomitant treatment with abatacept and TNF-inhibitors experienced more infections and serious infections than patients treated with only TNF-inhibitors. Therefore, concurrent therapy with abatacept and a TNF-inhibitor is not recommended.

Combination with other medicinal products

Population pharmacokinetic analyses did not detect any effect of methotrexate, NSAIDs, and corticosteroids on abatacept clearance (see section 5.2).

No major safety issues were identified with use of abatacept in combination with sulfasalazine, hydroxychloroquine, or leflunomide.

Combination with other medicinal products that affect the immune system and with vaccinations

Co-administration of abatacept with biologic immunosuppressive or immunomodulatory agents could potentiate the effects of abatacept on the immune system. There is insufficient evidence to assess the safety and efficacy of abatacept in combination with anakinra or rituximab (see section 4.4).

Vaccinations

Live vaccines should not be given concurrently with abatacept or within 3 months of its discontinuation. No data are available on the secondary transmission of infection from persons receiving live vaccines to patients receiving abatacept. Medicinal products that affect the immune system, including abatacept, may blunt the effectiveness of some immunisations (see sections 4.4 and 4.6).

Exploratory studies to assess the effect of abatacept on the antibody response to vaccination in healthy subjects as well as the antibody response to influenza and pneumococcal vaccines in rheumatoid arthritis patients suggested that abatacept may blunt the effectiveness of the immune response, but did not significantly inhibit the ability to develop a clinically significant or positive immune response.

Abatacept was evaluated in an open-label study in rheumatoid arthritis patients administered the 23-valent pneumococcal vaccine. After pneumococcal vaccination, 62 of 112 abatacept-treated patients were able to mount an adequate immune response of at least a 2-fold increase in antibody titers to pneumococcal polysaccharide vaccine.

Abatacept was also evaluated in an open-label study in rheumatoid arthritis patients administered the seasonal influenza trivalent virus vaccine. After influenza vaccination, 73 of 119 abatacept-treated patients without protective antibody levels at baseline were able to mount an adequate immune response of at least a 4-fold increase in antibody titers to trivalent influenza vaccine.

4.6 Fertility, pregnancy and lactation

Pregnancy and women of childbearing potential

There are no adequate data from use of abatacept in pregnant women. In pre-clinical embryo-foetal development studies no undesirable effects were observed at doses up to 29-fold a human 10 mg/kg dose based on AUC. In a pre- and postnatal development study in rats, limited changes in immune function were observed at 11-fold higher than a human 10 mg/kg dose based on AUC (see section 5.3).

ORENCIA should not be used during pregnancy unless the clinical condition of the woman requires treatment with abatacept. Women of childbearing potential have to use effective contraception during treatment and up to 14 weeks after the last dose of abatacept.

Abatacept may cross the placenta into the serum of infants born to women treated with abatacept during pregnancy. Consequently, these infants may be at increased risk of infection. The safety of administering live vaccines to infants exposed to abatacept *in utero* is unknown. Administration of live vaccines to infants exposed to abatacept *in utero* is not recommended for 14 weeks following the mother's last exposure to abatacept during pregnancy.

Breast-feeding

Abatacept has been shown to be present in rat milk.

It is unknown whether abatacept is excreted in human milk.

A risk to the newborns/infants cannot be excluded.

Breast-feeding should be discontinued during treatment with ORENCIA and for up to 14 weeks after the last dose of abatacept treatment.

Fertility

Formal studies of the potential effect of abatacept on human fertility have not been conducted. In rats, abatacept had no undesirable effects on male or female fertility (see section 5.3).

4.7 Effects on ability to drive and use machines

Based on its mechanism of action, abatacept is expected to have no or negligible influence on the ability to drive and use machines. However, dizziness and reduced visual acuity have been reported as common and uncommon adverse reactions respectively from patients treated with ORENCIA, therefore if a patient experiences such symptoms, driving and use of machinery should be avoided.

4.8 Undesirable effects

Summary of the safety profile in rheumatoid arthritis

Abatacept has been studied in patients with active rheumatoid arthritis in placebo-controlled clinical trials (2,653 patients with abatacept, 1,485 with placebo).

In placebo-controlled clinical trials with abatacept, adverse reactions (ARs) were reported in 49.4% of abatacept-treated patients and 45.8% of placebo-treated patients. The most frequently reported adverse reactions ($\geq 5\%$) among abatacept-treated patients were headache, nausea, and upper respiratory tract infections (including sinusitis). The proportion of patients who discontinued treatment due to ARs was 3.0% for abatacept-treated patients and 2.0% for placebo-treated patients.

Tabulated list of adverse reactions

Listed in Table 2 are adverse reactions observed in clinical trials and post-marketing experience presented by system organ class and frequency, using the following categories: very common ($\geq 1/10$); common ($\geq 1/100$ to $< 1/10$); uncommon ($\geq 1/1,000$ to $< 1/100$); rare ($\geq 1/10,000$ to $< 1/1,000$); very rare ($< 1/10,000$). Within each frequency grouping, undesirable effects are presented in order of decreasing seriousness.

Table 2: Adverse reactions

Infections and infestations	Very Common	Upper respiratory tract infection (including tracheitis, nasopharyngitis, and sinusitis)
	Common	Lower respiratory tract infection (including bronchitis), urinary tract infection, herpes infections (including herpes simplex, oral herpes, and herpes zoster), pneumonia, influenza
	Uncommon	Tooth infection, onychomycosis, sepsis, musculoskeletal infections, skin abscess, pyelonephritis, rhinitis, ear infection
	Rare	Tuberculosis, bacteraemia, gastrointestinal infection, pelvic inflammatory disease
Neoplasms benign, malignant and unspecified (incl. cysts and polyps)	Uncommon	Basal cell carcinoma, skin papilloma
	Rare	Lymphoma, lung neoplasm malignant, squamous cell carcinoma
Blood and lymphatic system disorders	Uncommon	Thrombocytopenia, leukopenia
Immune system disorders	Uncommon	Hypersensitivity
Psychiatric disorders	Uncommon	Depression, anxiety, sleep disorder (including insomnia)
Nervous system disorders	Common	Headache, dizziness
	Uncommon	Migraine, paraesthesia
Eye disorders	Uncommon	Conjunctivitis, dry eye, visual acuity reduced
Ear and labyrinth disorders	Uncommon	Vertigo
Cardiac disorders	Uncommon	Palpitations, tachycardia, bradycardia
Vascular disorders	Common	Hypertension, blood pressure increased
	Uncommon	Hypotension, hot flush, flushing, vasculitis, blood pressure decreased

Respiratory, thoracic and mediastinal disorders	Common	Cough
	Uncommon	Chronic obstructive pulmonary disease exacerbated, bronchospasm, wheezing, dyspnoea, throat tightness
Gastrointestinal disorders	Common	Abdominal pain, diarrhoea, nausea, dyspepsia, mouth ulceration, aphthous stomatitis, vomiting
	Uncommon	Gastritis
Hepatobiliary disorders	Common	Liver function test abnormal (including transaminases increased)
Skin and subcutaneous tissue disorders	Common	Rash (including dermatitis)
	Uncommon	Increased tendency to bruise, dry skin, alopecia, pruritus, urticaria, psoriasis, acne, erythema, hyperhidrosis
Musculoskeletal and connective tissue disorders	Uncommon	Arthralgia, pain in extremity
Reproductive system and breast disorders	Uncommon	Amenorrhea, menorrhagia
General disorders and administration site conditions	Common	Fatigue, asthenia, local injection site reactions, systemic injection reactions*
	Uncommon	Influenza like illness, weight increased

*(e.g. pruritus, throat tightness, dyspnoea)

Description of selected adverse reactions

Infections

In the placebo-controlled clinical trials with abatacept, infections at least possibly related to treatment were reported in 22.7% of abatacept-treated patients and 20.5% of placebo-treated patients.

Serious infections at least possibly related to treatment were reported in 1.5% of abatacept-treated patients and 1.1% of placebo-treated patients. The type of serious infections was similar between the abatacept and placebo treatment groups (see section 4.4).

The incidence rates (95% CI) for serious infections was 3.0 (2.3, 3.8) per 100 patient-years for abatacept-treated patients and 2.3 (1.5, 3.3) per 100 patient-years for placebo-treated patients in the double-blind studies.

In the cumulative period in clinical trials in 7,044 patients treated with abatacept during 20,510 patient-years, the incidence rate of serious infections was 2.4 per 100 patient-years, and the annualised incidence rate remained stable.

Malignancies

In placebo-controlled clinical trials, malignancies were reported in 1.2% (31/2,653) of abatacept-treated patients, and in 0.9% (14/1,485) of placebo-treated patients. The incidence rates for malignancies was 1.3 (0.9, 1.9) per 100 patient-years for abatacept-treated patients and 1.1 (0.6, 1.9) per 100 patient-years for placebo-treated patients.

In the cumulative period 7,044 patients treated with abatacept during 21,011 patient-years (of which over 1,000 were treated with abatacept for over 5 years), the incidence rate of malignancy was 1.2 (1.1, 1.4) per 100 patient-years, and the annualised incidence rates remained stable.

The most frequently reported malignancy in the placebo-controlled clinical trials was non-melanoma skin cancer; 0.6 (0.3, 1.0) per 100 patient-years for abatacept-treated patients and 0.4 (0.1, 0.9) per 100 patient-years for placebo-treated patients and 0.5 (0.4, 0.6) per 100 patient-years in the cumulative period.

The most frequently reported organ cancer in the placebo-controlled clinical trials was lung cancer 0.17 (0.05, 0.43) per 100 patient-years for abatacept-treated patients, 0 for placebo-treated patients and 0.12 (0.08, 0.17) per 100 patient-years in the cumulative period. The most common hematologic malignancy was lymphoma 0.04 (0, 0.24) per 100 patient-years for abatacept-treated patients, 0 for placebo-treated patients, and 0.06 (0.03, 0.1) per 100 patient-years in the cumulative period.

Adverse reactions in patients with chronic obstructive pulmonary disease (COPD)

In study IV, there were 37 patients with COPD treated with intravenous abatacept and 17 treated with placebo. The COPD patients treated with abatacept developed adverse reactions more frequently than those treated with placebo (51.4% vs. 47.1%, respectively). Respiratory disorders occurred more frequently in abatacept-treated patients than in placebo-treated patients (10.8% vs. 5.9%, respectively); these included COPD exacerbation, and dyspnoea. A greater percentage of abatacept- than placebo-treated patients with COPD developed a serious adverse reaction (5.4% vs. 0%), including COPD exacerbation (1 of 37 patients [2.7%]) and bronchitis (1 of 37 patients [2.7%]).

Autoimmune processes

Abatacept therapy did not lead to increased formation of autoantibodies, i.e., antinuclear and anti-dsDNA antibodies, compared with placebo.

The incidence rate of autoimmune disorders in abatacept-treated patients during the double-blind period was 8.8 (7.6, 10.1) per 100 person-years of exposure and for placebo-treated patients was 9.6 (7.9, 11.5) per 100 person-years of exposure. The incidence rate in abatacept-treated patients was 3.8 per 100 person-years in the cumulative period. The most frequently reported autoimmune-related disorders other than the indication being studied during the cumulative period were psoriasis, rheumatoid nodule, and Sjogren's syndrome.

Immunogenicity in adults treated with intravenous abatacept

Antibodies directed against the abatacept molecule were assessed by ELISA assays in 3,985 rheumatoid arthritis patients treated for up to 8 years with abatacept. One hundred and eighty-seven of 3,877 (4.8%) patients developed anti-abatacept antibodies while on treatment. In patients assessed for anti-abatacept antibodies after discontinuation of abatacept (> 42 days after last dose), 103 of 1,888 (5.5%) were seropositive.

Samples with confirmed binding activity to CTLA-4 were assessed for the presence of neutralizing antibodies. Twenty-two of 48 evaluable patients showed significant neutralizing activity. The potential clinical relevance of neutralizing antibody formation is not known.

Overall, there was no apparent correlation of antibody development to clinical response or adverse events. However, the number of patients that developed antibodies was too limited to make a definitive assessment. Because immunogenicity analyses are product-specific, comparison of antibody rates with those from other products is not appropriate.

Immunogenicity in adults treated with subcutaneous abatacept

Study SC-I compared the immunogenicity to abatacept following subcutaneous or intravenous administration as assessed by ELISA assay. During the initial double blind 6 months period (short-term period), the overall immunogenicity frequency to abatacept was 1.1% (8/725) and 2.3% (16/710) for the subcutaneous and intravenous groups, respectively. The rate is consistent with previous experience, and there was no effect of immunogenicity on pharmacokinetics, safety, or efficacy.

Immunogenicity to abatacept following long-term subcutaneous administration was assessed by a new electrochemiluminescence (ECL) assay. Comparison of incidence rates across different assays is not appropriate, as the ECL assay was developed to be more sensitive and drug tolerant than the previous ELISA assay. The cumulative immunogenicity frequency to abatacept by the ECL assay with at least one positive sample in the short-term and long-term periods combined was 15.7% (215/1369) while on abatacept, with a mean duration of exposure of 48.8 months, and 17.3% (194/1121) after discontinuation (> 21 days up to 168 days after last dose). The exposure adjusted incidence rate (expressed per 100 person-years) remained stable over the treatment duration.

Consistent with previous experience, titers and persistence of antibody responses were generally low and did not increase upon continued dosing (6.8% subjects were seropositive on 2 consecutive visits), and there was no apparent correlation of antibody development to clinical response, adverse events, or pharmacokinetics.

In study SC-III, similar immunogenicity rates were seen in patients on treatment for the abatacept+MTX, and abatacept monotherapy groups (2.9% (3/103) and 5.0% (5/101), respectively) during the double-blind 12-month period. As in study SC-I, there was no effect of immunogenicity on safety or efficacy.

Immunogenicity and safety of abatacept upon withdrawal and restart of treatment

A study in the subcutaneous program was conducted to investigate the effect of withdrawal (three months) and restart of abatacept subcutaneous treatment on immunogenicity. Upon withdrawal of abatacept subcutaneous treatment, the increased rate of immunogenicity was consistent with that seen upon discontinuation of abatacept administered intravenously. Upon reinitiating therapy, there were no injection reactions and no other safety concerns in patients who were withdrawn from subcutaneous therapy for up to 3 months relative to those who remained on subcutaneous therapy, whether therapy was reintroduced with or without an intravenous loading dose. The safety observed in the treatment arm that reinitiated therapy without an intravenous loading dose was also consistent with that observed in the other studies.

In SC-III, increased rates of immunogenicity were observed in subjects tested during 6 months of complete drug withdrawal in the abatacept+MTX and abatacept monotherapy groups (37.7% [29/77] and 44.1% [27/59], respectively) with generally low titer antibody responses. No clinical impact of these antibody responses was detected, and no safety concerns were observed upon reinitiation of abatacept therapy.

Injection Reactions in adult patients treated with subcutaneous abatacept

Study SC-I compared the safety of abatacept including injection site reactions following subcutaneous or intravenous administration. The overall frequency of injection site reactions was 2.6% (19/736) and 2.5% (18/721) for the subcutaneous abatacept group and the subcutaneous placebo group (intravenous abatacept), respectively. All injection site reactions were described as mild to moderate (hematoma, pruritus, or erythema) and generally did not necessitate drug discontinuation. During the cumulative study period when all subjects treated with abatacept in 7 SC studies were included, the frequency of injection site reactions was 4.6% (116/2,538) with an incidence rate of 1.32 per 100 person-years.

Postmarketing reports of systemic injection reactions (e.g. pruritus, throat tightness, dyspnoea) have been received following the use of subcutaneous ORENCIA.

Safety information related to the pharmacological class

Abatacept is the first selective co-stimulation modulator. Information on the relative safety in a clinical trial versus infliximab is summarised in section 5.1.

Summary of the safety profile in psoriatic arthritis

Abatacept has been studied in patients with active psoriatic arthritis in two placebo-controlled clinical trials (341 patients with abatacept, 253 patients with placebo) (see Section 5.1). During the 24-week placebo-controlled period in the larger study PsA-II, the proportion of patients with adverse reactions was similar in the abatacept and placebo treatment groups (15.5% and 11.4%, respectively). There were no adverse reactions that occurred at $\geq 2\%$ in either treatment group during the 24-week placebo-controlled period. The overall safety profile was comparable between studies PsA-I and PsA-II and consistent with the safety profile in rheumatoid arthritis (Table 2).

Paediatric population

Abatacept has been studied in patients with pJIA in 2 clinical trials (ongoing pJIA SC study and pJIA IV study). The pJIA SC study included 46 patients in the 2 to 5 year age cohort and 173 patients in the 6 to 17 year age cohort. The pJIA IV study included 190 patients in the 6 to 17 year age cohort. During the first 4-month open-label period, the overall safety profile in these 409 pJIA patients was similar to that observed in the RA population with the following exceptions in the pJIA patients:

- Common adverse reactions: pyrexia
- Uncommon adverse reactions: haematuria, otitis (media and externa).

Description of selected adverse reactions

Infections

Infections were the most commonly reported adverse events in patients with pJIA. The types of infections were consistent with those commonly seen in outpatient paediatric populations. During the first 4-month treatment period of intravenous and subcutaneous abatacept in 409 patients with pJIA, the most common adverse reactions were nasopharyngitis (3.7% patients) and upper respiratory tract infection (2.9% patients). Two serious infections (varicella and sepsis) were reported during the initial 4 months of treatment with abatacept.

Injection reactions

Of the 219 patients with pJIA treated with subcutaneous abatacept during the first 4-month abatacept treatment, the frequency of local injection reactions was 4.6% (10/219); injection site pain and injection site erythema were the most frequently reported local injection reactions. No systemic hypersensitivity reactions were reported.

Immunogenicity in patients with pJIA treated with subcutaneous abatacept

Antibodies directed against the whole abatacept molecule or to the CTLA-4 portion of abatacept were assessed by an ECL assay in patients with pJIA following repeated treatment with subcutaneous abatacept. Overall, 6.9% (15/218) of subjects (cohorts combined) had a positive immunogenicity response relative to baseline during the cumulative period, including the 4-month short-term treatment period, 20-month extension treatment period and the 6-month post abatacept follow-up period. In the 6 to 17 year age cohort, the overall rate of seropositivity during the cumulative period including post abatacept follow-up was 4.7% (8/172): 2.3% (4/172) on treatment and 13.6% (6/44) after discontinuation of abatacept (≥ 28 days after the last dose). In the 2 to 5 year age cohort, the overall rate of seropositivity during the cumulative period including post abatacept follow-up was 15.2% (7/46): 10.9% (5/46) on treatment and 37.5% (3/8) after discontinuation of abatacept (≥ 28 days after the last dose).

Overall antibodies against abatacept were generally transient and of low titer. The absence of concomitant methotrexate did not appear to be associated with a higher rate of seropositivity. The significance of the higher incidence in the 2 to 5 year age cohort is unknown, taking into account the

difference in sample size. The presence of antibodies was not associated with adverse reactions, or with changes in efficacy or serum abatacept concentrations, in either cohort.

Long-term extension period

During the extension period of the pJIA studies (20 months in the pJIA ongoing SC study and 5 years in the pJIA IV study), the safety profile in the pJIA patients aged 6 to 17 years was comparable to that seen in adult patients. One patient was diagnosed with multiple sclerosis while in the extension period of the pJIA IV study. One serious adverse reaction of infection (limb abscess) was reported in the 2 to 5 year age cohort during the 20-month extension period of the pJIA SC study.

Long-term safety data in 2 to 5 year age cohort with pJIA was limited, but the existing evidence did not reveal any new safety concern in this younger paediatric population. During the 24-month cumulative period of the pJIA SC study (4-month short-term period plus 20-month extension period), a higher frequency of infections was reported in the 2 to 5 year age cohort (87.0%) compared to that reported in the 6 to 17 year age cohort (68.2%). This was mostly due to non-serious upper respiratory tract infections in the 2 to 5 year age cohort.

Reporting of suspected adverse reactions

Reporting suspected adverse reactions after authorisation of the medicinal product is important. It allows continued monitoring of the benefit/risk balance of the medicinal product. Healthcare professionals are asked to report any suspected adverse reactions via [the national reporting system listed in Appendix V](#).

4.9 Overdose

Doses up to 50 mg/kg have been administered intravenously without apparent toxic effect. In case of overdose, it is recommended that the patient be monitored for any signs or symptoms of adverse reactions and appropriate symptomatic treatment instituted.

5. PHARMACOLOGICAL PROPERTIES

5.1 Pharmacodynamic properties

Pharmacotherapeutic group: Immunosuppressants, selective immunosuppressants, ATC code: L04AA24

Abatacept is a fusion protein that consists of the extracellular domain of human cytotoxic T-lymphocyte-associated antigen 4 (CTLA-4) linked to a modified Fc portion of human immunoglobulin G1 (IgG1). Abatacept is produced by recombinant DNA technology in Chinese hamster ovary cells.

Mechanism of action

Abatacept selectively modulates a key costimulatory signal required for full activation of T lymphocytes expressing CD28. Full activation of T lymphocytes requires two signals provided by antigen presenting cells: recognition of a specific antigen by a T cell receptor (signal 1) and a second, costimulatory signal. A major costimulatory pathway involves the binding of CD80 and CD86 molecules on the surface of antigen presenting cells to the CD28 receptor on T lymphocytes (signal 2). Abatacept selectively inhibits this costimulatory pathway by specifically binding to CD80 and CD86. Studies indicate that naive T lymphocyte responses are more affected by abatacept than memory T lymphocyte responses.

Studies *in vitro* and in animal models demonstrate that abatacept modulates T lymphocyte-dependent antibody responses and inflammation. *In vitro*, abatacept attenuates human T lymphocyte activation as

measured by decreased proliferation and cytokine production. Abatacept decreases antigen specific TNF α , interferon- γ , and interleukin-2 production by T lymphocytes.

Pharmacodynamic effects

Dose-dependent reductions were observed with abatacept in serum levels of soluble interleukin-2 receptor, a marker of T lymphocyte activation; serum interleukin-6, a product of activated synovial macrophages and fibroblast-like synoviocytes in rheumatoid arthritis; rheumatoid factor, an autoantibody produced by plasma cells; and C-reactive protein, an acute phase reactant of inflammation. In addition, serum levels of matrix metalloproteinase-3, which produces cartilage destruction and tissue remodelling, were decreased. Reductions in serum TNF α were also observed.

Clinical efficacy and safety in adult rheumatoid arthritis

The efficacy and safety of intravenous abatacept were assessed in randomised, double-blind, placebo-controlled clinical trials in adult patients with active rheumatoid arthritis diagnosed according to American College of Rheumatology (ACR) criteria. Studies I, II, III, V, and VI required patients to have at least 12 tender and 10 swollen joints at randomisation. Study IV did not require any specific number of tender or swollen joints. Study SC-I was a randomised, double-blind, double-dummy non-inferiority study administered to patients stratified by body weight (< 60 kg, 60 to 100 kg, > 100 kg) that compared the efficacy and safety of abatacept administered subcutaneously and intravenously in subjects with rheumatoid arthritis (RA), receiving background methotrexate (MTX), and experiencing an inadequate response to MTX (MTX-IR).

In studies I, II, and V the efficacy and safety of abatacept compared to placebo were assessed in patients with an inadequate response to methotrexate and who continued on their stable dose of methotrexate. In addition, study V investigated the safety and efficacy of abatacept or infliximab relative to placebo. In study III the efficacy and safety of abatacept were assessed in patients with an inadequate response to a TNF-inhibitor, with the TNF-inhibitor discontinued prior to randomisation; other DMARDs were permitted. Study IV primarily assessed safety in patients with active rheumatoid arthritis requiring additional intervention in spite of current therapy with non-biological and/or biological DMARDs; all DMARDs used at enrollment were continued. In study VI, the efficacy and safety of abatacept were assessed in methotrexate-naive, Rheumatoid Factor (RF) and/or anti-Cyclic Citrullinated Peptide 2 (Anti-CCP2)-positive patients with early, erosive rheumatoid arthritis (≤ 2 years disease duration) who were randomised to receive abatacept plus methotrexate or methotrexate plus placebo. In study SC-I, the goal was to demonstrate non-inferiority of the efficacy and comparability of the safety of abatacept subcutaneous relative to intravenous administration in subjects with moderate to severely active RA and experiencing inadequate response to MTX. Study SC-II investigated the relative efficacy and safety of abatacept and adalimumab, both given subcutaneously without an intravenous loading dose and with background MTX, in patients with moderate to severely active RA and an inadequate response to previous MTX therapy. In study SC-III, abatacept subcutaneous was evaluated in combination with methotrexate, or as abatacept monotherapy, and compared to MTX monotherapy in induction of remission following 12 months of treatment, and the possible maintenance of drug-free remission after complete drug withdrawal, in adult MTX-naive patients with highly active early rheumatoid arthritis (mean DAS28-CRP of 5.4; mean symptom duration less than 6.7 months) with poor prognostic factors for rapidly progressive disease (e.g. anti-citrullinated protein antibodies [ACPA+], as measured by anti-CCP2 assay, and/or RF+, baseline joint erosions).

Study I patients were randomised to receive abatacept 2 or 10 mg/kg or placebo for 12 months. Study II, III, IV, and VI patients were randomised to receive a fixed dose approximating 10 mg/kg of abatacept or placebo for 12 (studies II, IV, and VI) or 6 months (study III). The dose of abatacept was 500 mg for patients weighing less than 60 kg, 750 mg for patients weighing 60 to 100 kg, and 1,000 mg for patients weighing greater than 100 kg. In study SC-I, abatacept was given subcutaneously to patients after a single loading dose of intravenous abatacept and then every week thereafter. Subjects continued taking their current dose of MTX from the day of randomisation. Study V patients were randomised to receive this same fixed dose of abatacept or 3 mg/kg infliximab

or placebo for 6 months. Study V continued for an additional 6 months with the abatacept and infliximab groups only.

Studies I, II, III, IV, V, VI, SC-I, SC-II, and SC-III evaluated 339, 638, 389, 1441, 431, 509, 1371, 646, and 351 adult patients, respectively.

Clinical response

ACR response

The percent of abatacept-treated patients achieving ACR 20, 50, and 70 responses in study II (patients with inadequate response to methotrexate), study III (patients with inadequate response to TNF-inhibitor), study VI (methotrexate-naïve patients), and study SC-I (subcutaneous abatacept) are shown in Table 3.

In abatacept-treated patients in studies II and III, statistically significant improvement in the ACR 20 response versus placebo was observed after administration of the first dose (day 15), and this improvement remained significant for the duration of the studies. In study VI, statistically significant improvement in the ACR 20 response in abatacept plus methotrexate-treated patients versus methotrexate plus placebo-treated patients was observed at 29 days, and was maintained through the duration of the study. In study II, 43% of the patients who had not achieved an ACR 20 response at 6 months developed an ACR 20 response at 12 months.

In study SC-I, abatacept administered subcutaneously (SC) was non-inferior relative to intravenous IV infusions of abatacept with respect to ACR 20 responses up to 6 months of treatment. Patients treated with abatacept subcutaneously also achieved similar ACR 50 and 70 responses as those patients receiving abatacept intravenously at 6 months.

No difference in clinical response between subcutaneous and intravenous abatacept was seen across the 3 weight groups. In SC-I, the ACR 20 response rates at day 169 for subcutaneous and intravenous abatacept were respectively 78.3% (472/603 SC) and 76.0% (456/600 IV) in patients < 65 years, versus 61.1% (55/90 SC) and 74.4% (58/78 IV) for patients ≥ 65 years.

Table 3: Clinical responses in controlled trials

	Percent of patients							
	Intravenous administration						Subcutaneous administration	
	MTX-Naive		Inadequate response to MTX		Inadequate response to TNF Inhibitor		Inadequate response to MTX	
	Study VI		Study II		Study III		Study SC-I	
Response Rate	Abatacept ^a +MTX n = 256	Placebo +MTX n = 253	Abatacept ^a +MTX n = 424	Placebo +MTX n = 214	Abatacept ^a +DMARDs ^b n = 256	Placebo +DMARDs ^b n = 133	Abatacept ^f SC +MTX n = 693	Abatacept ^f IV +MTX n = 678
ACR 20								
Day 15	24%	18%	23%*	14%	18%**	5%	25%	25%
Month 3	64% ^{††}	53%	62%***	37%	46%***	18%	68%	69%
Month 6	75% [†]	62%	68%***	40%	50%***	20%	76% [§]	76%
Month 12	76% [‡]	62%	73%***	40%	NA ^d	NA ^d	NA	NA

	Percent of patients							
	Intravenous administration						Subcutaneous administration	
	MTX-Naive		Inadequate response to MTX		Inadequate response to TNF Inhibitor		Inadequate response to MTX	
	Study VI		Study II		Study III		Study SC-I	
Response Rate	Abatacept ^a +MTX n = 256	Placebo +MTX n = 253	Abatacept ^a +MTX n = 424	Placebo +MTX n = 214	Abatacept ^a +DMARDs ^b n = 256	Placebo +DMARDs ^b n = 133	Abatacept ^f SC +MTX n = 693	Abatacept ^f IV +MTX n = 678
ACR 50								
Month 3	40% [‡]	23%	32%***	8%	18%**	6%	33%	39%
Month 6	53% [‡]	38%	40%***	17%	20%***	4%	52%	50%
Month 12	57% [‡]	42%	48%***	18%	NA ^d	NA ^d	NA	NA
ACR 70								
Month 3	19% [†]	10%	13%***	3%	6% ^{††}	1%	13%	16%
Month 6	32% [†]	20%	20%***	7%	10%**	2%	26%	25%
Month 12	43% [‡]	27%	29%***	6%	NA ^d	NA ^d	NA	NA
Major Clinical Response^c	27% [‡]	12%	14%***	2%	NA ^d	NA ^d	NA	NA
DAS28-CRP Remission^e								
Month 6	28% [‡]	15%	NA	NA	NA	NA	24% ^{§§}	25%
Month 12	41% [‡]	23%	NA	NA	NA	NA	NA	NA

* p < 0.05, abatacept vs. placebo.

** p < 0.01, abatacept vs. placebo.

*** p < 0.001, abatacept vs. placebo.

† p < 0.01, abatacept plus MTX vs. MTX plus placebo

‡ p < 0.001, abatacept plus MTX vs. MTX plus placebo

†† p < 0.05, abatacept plus MTX vs. MTX plus placebo

§ 95% CI: -4.2, 4.8 (based on prespecified margin for non-inferiority of -7.5%)

§§ITT data is presented in table

^a Fixed dose approximating 10 mg/kg (see section 4.2).

^b Concurrent DMARDs included one or more of the following: methotrexate, chloroquine/hydroxychloroquine, sulfasalazine, leflunomide, azathioprine, gold, and anakinra.

^c Major clinical response is defined as achieving an ACR 70 response for a continuous 6-month period.

^d After 6 months, patients were given the opportunity to enter an open-label study.

^e DAS28-CRP Remission is defined as a DAS28-CRP score < 2.6

^f Per protocol data is presented in table. For ITT; n = 736, 721 for subcutaneous (SC) and intravenous (IV) abatacept, respectively

In the open-label extension of studies I, II, III, VI, and SC-I durable and sustained ACR 20, 50, and 70 responses have been observed through 7 years, 5 years, 5 years, 2 years, and 5 years, respectively, of abatacept treatment. In study I, ACR responses were assessed at 7 years in 43 patients with 72% ACR 20 responses, 58% ACR 50 responses, and 44% ACR 70 responses. In study II, ACR responses were assessed at 5 years in 270 patients with 84% ACR 20 responses, 61% ACR 50 responses, and 40% ACR 70 responses. In study III, ACR responses were assessed at 5 years in 91 patients with 74% ACR 20 responses, 51% ACR 50 responses, and 23% ACR 70 responses. In study VI, ACR responses were assessed at 2 years in 232 patients with 85% ACR 20 responses, 74% ACR 50 responses, and 54% ACR 70 responses. In study SC-I, ACR responses were assessed at

5 years with 85% (356/421) ACR 20 responses, 66% (277/423) ACR 50 responses, and 45% (191/425) ACR 70 responses.

Greater improvements were seen with abatacept than with placebo in other measures of rheumatoid arthritis disease activity not included in the ACR response criteria, such as morning stiffness.

DAS28 response

Disease activity was also assessed using the Disease Activity Score 28. There was a significant improvement of DAS in studies II, III, V, and VI as compared to placebo or comparator.

In study VI, which only included adults, a significantly higher proportion of patients in the abatacept plus methotrexate group (41%) achieved DAS28 (CRP)-defined remission (score < 2.6) versus the methotrexate plus placebo group (23%) at year 1. The response at year 1 in the abatacept group was maintained through year 2.

Study V: abatacept or infliximab versus placebo

A randomised, double-blind study was conducted to assess the safety and efficacy of intravenous abatacept or infliximab versus placebo in patients with an inadequate response to methotrexate (study V). The primary outcome was the mean change in disease activity in abatacept-treated patients compared to placebo-treated patients at 6 months with a subsequent double-blind assessment of safety and efficacy of abatacept and infliximab at 12 months. Greater improvement ($p < 0.001$) in DAS28 was observed with abatacept and with infliximab compared to placebo at six months in the placebo-controlled portion of the trial; the results between the abatacept and infliximab groups were similar. The ACR responses in study V were consistent with the DAS28 score. Further improvement was observed at 12 months with abatacept. At 6 months, the incidence of AE of infections were 48.1% (75), 52.1% (86), and 51.8% (57) and the incidence of serious AE of infections were 1.3% (2), 4.2% (7), and 2.7% (3) for abatacept, infliximab and placebo groups, respectively. At 12 months, the incidence of AE of infections were 59.6% (93), 68.5% (113), and the incidence of serious AE of infections were 1.9% (3) and 8.5% (14) for abatacept and infliximab groups, respectively. The open label period of the study provided an assessment of the ability of abatacept to maintain efficacy for subjects originally randomised to abatacept and the efficacy response of those subjects who were switched to abatacept following treatment with infliximab. The reduction from baseline in mean DAS28 score at day 365 (-3.06) was maintained through day 729 (-3.34) in those patients who continued with abatacept. In those patients who initially received infliximab and then switched to abatacept, the reduction in the mean DAS28 score from baseline were 3.29 at day 729 and 2.48 at day 365.

Study SC-II: abatacept versus adalimumab

A randomised, single (investigator)-blinded, non-inferiority study was conducted to assess the safety and efficacy of weekly subcutaneous (SC) abatacept without an abatacept intravenous (IV) loading dose versus every-other-weekly subcutaneous adalimumab, both with background MTX, in patients with an inadequate response to methotrexate (study SC-II). The primary endpoint showed non-inferiority (predefined margin of 12%) of ACR20 response after 12 months of treatment, 64.8% (206/318) for the abatacept SC group and 63.4% (208/328) for the adalimumab SC group; treatment difference was 1.8% [95% confidence interval (CI): -5.6, 9.2], with comparable responses throughout the 24-month period. The respective values for ACR 20 at 24 months were 59.7% (190/318) for the abatacept SC group and 60.1% (197/328) for the adalimumab SC group. The respective values for ACR 50 and ACR 70 at 12 months and 24 months were consistent and similar for abatacept and adalimumab. The adjusted mean changes (standard error; SE) from baseline in DAS28-CRP were -2.35 (SE 0.08) [95% CI: -2.51, -2.19] and -2.33 (SE 0.08) [95% CI: -2.50, -2.17] in the SC abatacept group and the adalimumab group, respectively, at 24 months, with similar changes over time. At 24 months, 50.6% (127/251) [95% CI: 44.4, 56.8] of patients in abatacept and 53.3% (130/244) [95% CI: 47.0, 59.5] of patients in adalimumab groups achieved DAS 28 < 2.6. Improvement from baseline as measured by HAQ-DI at 24 months and over time was also similar between abatacept SC and adalimumab SC.

Safety and structural damage assessments were conducted at one and two years. The overall safety profile with respect to adverse reactions was similar between the two groups over the 24-month period. After 24 months, adverse reactions were reported in 41.5% (132/318) and 50% (164/328) of abatacept and adalimumab-treated patients. Serious adverse reactions were reported in 3.5% (11/318) and 6.1% (20/328) of the respective group. At 24 months, 20.8% (66/318) of patients on abatacept and 25.3% (83/328) on adalimumab had discontinued.

In SC-II, serious infections were reported in 3.8% (12/318) of patients treated with abatacept SC weekly, none of which led to discontinuation and in 5.8% (19/328) of patients treated with adalimumab SC every-other-week, leading to 9 discontinuations in the 24-month period.

The frequency of local injection site reactions was 3.8% (12/318) and 9.1% (30/328) at 12 months ($p = 0.006$) and 4.1% (13/318) and 10.4% (34/328) at 24 months for abatacept SC and adalimumab SC, respectively. Over the 2 year study period, 3.8% (12/318) and 1.5% (5/328) patients treated with abatacept SC and adalimumab SC respectively reported autoimmune disorders mild to moderate in severity (e.g., psoriasis, Raynaud's phenomenon, erythema nodosum).

Study SC-III: Induction of remission in methotrexate-naive RA patients

A randomised and double-blinded study evaluated abatacept SC in combination with methotrexate (abatacept + MTX), abatacept SC monotherapy, or methotrexate monotherapy (MTX group) in induction of remission following 12 months of treatment, and maintenance of drug-free remission after complete drug withdrawal in MTX-naive adult patients with highly active early rheumatoid arthritis with poor prognostic factors. Complete drug withdrawal led to loss of remission (return to disease activity) in all three treatment arms (abatacept with methotrexate, abatacept or methotrexate alone) in a majority of patients (Table 4).

Table 4: Remission rates at end of drug treatment and drug withdrawal phases in study SC-III

Number of patients	Abatacept SC + MTX n = 119	MTX n = 116	Abatacept SC n = 116
Proportion of randomised patients with induction of remission after 12 months of treatment			
DAS28-Remission ^a	60.9%	45.2%	42.5%
Odds Ratio (95% CI) vs. MTX	2.01 (1.18, 3.43)	N/A	0.92 (0.55, 1.57)
P value	0.010	N/A	N/A
SDAI Clinical Remission ^b	42.0%	25.0%	29.3%
Estimate of Difference (95% CI) vs. MTX	17.02 (4.30, 29.73)	N/A	4.31 (-7.98, 16.61)
Boolean Clinical Remission	37.0%	22.4%	26.7%
Estimate of Difference (95% CI) vs. MTX	14.56 (2.19, 26.94)	N/A	4.31 (-7.62, 16.24)
Proportion of randomised patients in remission at 12 months and at 18 months (6 months of complete drug withdrawal)			
DAS28-Remission ^a	14.8%	7.8%	12.4%
Odds Ratio (95% CI) vs. MTX	2.51 (1.02, 6.18)	N/A	2.04 (0.81, 5.14)
P value	0.045	N/A	N/A

^a DAS28-defined remission (DAS28-CRP < 2.6)

^b SDAI criterion (SDAI ≤ 3.3)

In SC-III the safety profiles of the three treatment groups (abatacept + MTX, abatacept monotherapy, MTX group) were overall similar. During the 12-month treatment period, adverse reactions were reported in 44.5% (53/119), 41.4% (48/116), and 44.0% (51/116) and serious adverse reactions were

reported in 2.5% (3/119), 2.6% (3/116) and 0.9% (1/116) of patients treated in the three treatment groups, respectively. Serious infections were reported in 0.8% (1/119), 3.4% (4/116) and 0% (0/116) patients.

Radiographic response

Structural joint damage was assessed radiographically over a two-year period in studies II, VI, and SC-II. The results were measured using the Genant-modified total Sharp score (TSS) and its components, the erosion score and joint space narrowing (JSN) score.

In study II, the baseline median TSS was 31.7 in abatacept-treated patients and 33.4 in placebo-treated patients. Abatacept/methotrexate reduced the rate of progression of structural damage compared to placebo/methotrexate after 12 months of treatment as shown in Table 5. The rate of progression of structural damage in year 2 was significantly lower than that in year 1 for patients randomised to abatacept ($p < 0.0001$). Subjects entering the long term extension after 1 year of double blind treatment all received abatacept treatment and radiographic progression was investigated through year 5. Data were analysed in an as-observed analysis using mean change in total score from the previous annual visit. The mean change was, 0.41 and 0.74 from year 1 to year 2 ($n = 290, 130$), 0.37 and 0.68 from year 2 to year 3 ($n = 293, 130$), 0.34 and 0.43 from year 3 to year 4 ($n = 290, 128$) and the change was 0.26 and 0.29 ($n = 233, 114$) from year 4 to year 5 for patients originally randomised to abatacept plus MTX and placebo plus MTX respectively.

Table 5: Mean radiographic changes over 12 months in study II

Parameter	Abatacept/MTX n = 391	Placebo/MTX n = 195	P-value ^a
Total Sharp score	1.21	2.32	0.012
Erosion score	0.63	1.14	0.029
JSN score	0.58	1.18	0.009

^a Based on non-parametric analysis.

In study VI, the mean change in TSS at 12 months was significantly lower in patients treated with abatacept plus methotrexate compared to those treated with methotrexate plus placebo. At 12 months 61% (148/242) of the patients treated with abatacept plus methotrexate and 53% (128/242) of the patients treated with methotrexate plus placebo had no progression ($TSS \leq 0$). The progression of structural damage was lower in patients receiving continuous abatacept plus methotrexate treatment (for 24 months) compared to patients who initially received methotrexate plus placebo (for 12 months) and were switched to abatacept plus methotrexate for the next 12 months. Among the patients who entered the open-label 12-month period, 59% (125/213) of patients receiving continuous abatacept plus methotrexate treatment and 48% (92/192) of patients who initially received methotrexate and switched to combination with abatacept had no progression.

In study SC-II, structural joint damage was assessed radiographically and expressed as a change from baseline in the van der Heijde-modified Total Sharp Score (mTSS) and its components. Similar inhibition was observed in both treatment groups up to 24 months (mTSS (mean \pm standard deviation [SD]) = 0.89 \pm 4.13 vs 1.13 \pm 8.66), erosion score (0.41 \pm 2.57 vs 0.41 \pm 5.04), and JSN score (0.48 \pm 2.18 vs 0.72 \pm 3.81)) for the abatacept ($n = 257$) and adalimumab ($n = 260$) groups, respectively.

In study SC-III, structural joint damage was assessed by MRI. The abatacept + MTX group had less progression in structural damage compared with MTX group as reflected by mean treatment difference of the abatacept + MTX group versus MTX group (Table 6).

Table 6: Structural and inflammatory MRI assessment in study SC-III

Mean Treatment Difference between Abatacept SC+MTX vs. MTX at 12 Months (95% CI)*

MRI Erosion Score	-1.22 (-2.20, -0.25)
MRI Osteitis/Bone Oedema Score	-1.43 (-2.68, -0.18)
MRI Synovitis Score	-1.60 (-2.42, -0.78)

* n = 119 for Abatacept SC + MTX; n = 116 for MTX

Physical function response

Improvement in physical function was measured by the Health Assessment Questionnaire Disability Index (HAQ-DI) in studies II, III, IV, V, and VI and the modified HAQ-DI in study I. In study SC-I, improvement from baseline as measured by HAQ-DI at 6 months and over time was similar between subcutaneous and intravenous administration. The results from studies II, III, and VI are shown in Table 7.

Table 7: Improvement in physical function in controlled trials

	Methotrexate-Naive		Inadequate response to Methotrexate		Inadequate response to TNF Inhibitor	
	Study VI		Study II		Study III	
HAQ ^c Disability Index	Abatacept ^a +MTX	Placebo +MTX	Abatacept ^a +MTX	Placebo +MTX	Abatacept ^a +DMARDs ^b	Placebo +DMARDs ^b
Baseline (Mean)	1.7 (n = 254)	1.7 (n = 251)	1.69 (n = 422)	1.69 (n = 212)	1.83 (n = 249)	1.82 (n = 130)
Mean Improvement from Baseline						
Month 6	0.85 (n = 250)	0.68 (n = 249)	0.59*** (n = 420)	0.40 (n = 211)	0.45*** (n = 249)	0.11 (n = 130)
Month 12	0.96 (n = 254)	0.76 (n = 251)	0.66*** (n = 422)	0.37 (n = 212)	NA ^c	NA ^c
Proportion of patients with a clinically meaningful improvement ^d						
Month 6	72% [†]	63%	61%***	45%	47%***	23%
Month 12	72% [†]	62%	64%***	39%	NA ^c	NA ^c

*** p < 0.001, abatacept vs. placebo.

† p < 0.05, abatacept plus MTX vs MTX plus placebo

^a Fixed dose approximating 10 mg/kg (see section 4.2).^b Concurrent DMARDs included one or more of the following: methotrexate, chloroquine/hydroxychloroquine, sulfasalazine, leflunomide, azathioprine, gold, and anakinra.^c Health Assessment Questionnaire; 0 = best, 3 = worst; 20 questions; 8 categories: dressing and grooming, arising, eating, walking, hygiene, reach, grip, and activities.^d Reduction in HAQ-DI of ≥ 0.3 units from baseline.^e After 6 months, patients were given the opportunity to enter into an open-label study.

In study II, among patients with clinically meaningful improvement at month 12, 88% retained the response at month 18, and 85% retained the response at month 24. During the open-label periods of

studies I, II, III, and VI the improvement in physical function has been maintained through 7 years, 5 years, 5 years, and 2 years, respectively.

In study SC-III, the proportion of subjects with a HAQ response as a measure of clinically meaningful improvement in physical function (reduction from baseline in HAQ-D1 score of ≥ 0.3) was greater for the abatacept + MTX group vs. the MTX group at month 12 (65.5% vs 44.0%, respectively; treatment difference vs. MTX group of 21.6% [95% CI: 8.3, 34.9]).

Health-related outcomes and quality of life

Health-related quality of life was assessed by the SF-36 questionnaire at 6 months in studies I, II, and III and at 12 months in studies I and II. In these studies, clinically and statistically significant improvement was observed in the abatacept group as compared with the placebo group in all 8 domains of the SF-36 (4 physical domains: physical function, role physical, bodily pain, general health; and 4 mental domains: vitality, social function, role emotional, mental health), as well as the Physical Component Summary (PCS) and the Mental Component Summary (MCS). In study VI, improvement was observed at 12 months in abatacept plus methotrexate group as compared with the methotrexate plus placebo group in both PCS and MCS, and was maintained through 2 years.

Study VII: Safety of abatacept in patients with or without washout of previous TNF-inhibitor therapy

A study of open-label intravenous abatacept on a background of nonbiologic DMARDs was conducted in patients with active RA who had an inadequate response to previous (washout for at least 2 months; n = 449) or current (no washout period; n = 597) TNF-inhibitor therapy (study VII). The primary outcome, incidence of AEs, SAEs, and discontinuations due to AEs during 6 months of treatment, was similar between those who were previous and current TNF-inhibitor users at enrollment, as was the frequency of serious infections.

Clinical efficacy and safety in adult psoriatic arthritis

The efficacy and safety of abatacept were assessed in two randomised, double-blind, placebo-controlled trials (studies PsA-I and PsA-II) in adult patients, age 18 years and older. Patients had active PsA (≥ 3 swollen joints and ≥ 3 tender joints) despite prior treatment with DMARD therapy and had one qualifying psoriatic skin lesion of at least 2 cm in diameter.

In study PsA-I, 170 patients received placebo or abatacept intravenously on day 1, 15, 29, and then every 28 days thereafter in a double blind manner for 24 weeks, followed by open-label abatacept 10 mg/kg intravenous every 28 days. Patients were randomised to receive placebo or abatacept 3 mg/kg, 10 mg/kg, or two doses of 30 mg/kg followed by 10 mg/kg, without escape for 24 weeks, followed by open label abatacept 10 mg/kg monthly intravenous every month. Patients were allowed to receive stable doses of concomitant methotrexate, low dose corticosteroids (equivalent to ≤ 10 mg of prednisone) and/or NSAIDs during the trial.

In study PsA-II, 424 patients were randomised 1:1 to receive in a double-blind manner weekly doses of subcutaneous placebo or abatacept 125 mg without a loading dose for 24 weeks, followed by open-label abatacept 125 mg subcutaneous weekly. Patients were allowed to receive stable doses of concomitant methotrexate, sulfasalazine, leflunomide, hydroxychloroquine, low dose corticosteroids (equivalent to ≤ 10 mg of prednisone) and/or NSAIDs during the trial. Patients who had not achieved at least a 20% improvement from baseline in their swollen and tender joint counts by Week 16 escaped to open-label abatacept 125 mg subcutaneous weekly.

The primary endpoint for both PsA-I and PsA-II was the proportion of patients achieving ACR 20 response at Week 24 (day 169).

Clinical Response

Signs and symptoms

The percent of patients achieving ACR 20, 50, or 70 responses at the recommended abatacept dose in studies PsA-I (10 mg/kg intravenous) and PsA-II (125 mg subcutaneous) are presented in Table 8 below.

Table 8: Proportion of patients with ACR responses at week 24 in studies PsA-I and PsA-II

	PsA-I ^a			PsA-II ^{b,c}		
	Abatacept 10 mg/kg IV N = 40	Placebo N = 42	Estimate of difference (95% CI)	Abatacept 125 mg SC N = 213	Placebo N = 211	Estimate of difference (95% CI)
ACR 20	47.5%*	19.0%	28.7 (9.4, 48.0)	39.4%*	22.3%	17.2 (8.7, 25.6)
ACR 50	25.0%	2.4%	22.7 (8.6, 36.9)	19.2%	12.3%	6.9 (0.1, 13.7)
ACR 70	12.5%	0%	12.5 (2.3, 22.7)	10.3%	6.6%	3.7 (-1.5, 8.9)

* p < 0.05 vs placebo, p values not assessed for ACR 50 and ACR 70.

^a 37% of patients were previously treated with TNF inhibitor.

^b 61% of patients were previously treated with TNF inhibitor.

^c Patients who had less than 20% improvement in tender or swollen joint counts at Week 16 met escape criteria and were considered non-responders.

A significantly higher proportion of patients achieved an ACR 20 response after treatment with abatacept 10 mg/kg intravenous in PsA-I or 125 mg subcutaneous in PsA-II compared to placebo at Week 24 in the overall study populations. Higher ACR 20 responses were observed with abatacept vs placebo regardless of prior TNF-inhibitor treatment in both studies. In the smaller study PsA-I, the ACR 20 responses with abatacept 10 mg/kg intravenous vs placebo in patients who were TNF inhibitor-naïve were 55.6% vs 20.0%, respectively, and in patients who were TNF inhibitor-experienced were 30.8% vs 16.7%, respectively. In study PsA-II, the ACR 20 responses with abatacept 125 mg subcutaneous vs placebo in patients who were TNF inhibitor-naïve were 44.0% vs 22.2%, respectively (21.9 [8.3, 35.6], estimate of difference [95% CI]), and in patients who were TNF inhibitor-experienced were 36.4% vs 22.3%, respectively (14.0 [3.3, 24.8], estimate of difference [95% CI]).

Higher ACR 20 responses in study PsA-II were seen with abatacept 125 mg subcutaneous vs. placebo irrespective of concomitant non-biological DMARD treatment. The ACR 20 responses with abatacept 125 mg subcutaneous vs placebo in patients who did not use non-biological DMARDs were 27.3% vs 12.1%, respectively, (15.15 [1.83, 28.47], estimate of difference [95% CI]), and in patients who had used non-biological DMARDs were 44.9% vs 26.9%, respectively, (18.00 [7.20, 28.81], estimate of difference [95% CI]). Clinical responses were maintained or continued to improve up to one year in studies PsA-I and PsA-II.

Structural response

In study PsA-II, the proportion of radiographic non-progressors (≤ 0 change from baseline) in total PsA-modified SHS on x-rays at Week 24 was greater with abatacept 125 mg subcutaneous (42.7%) than placebo (32.7%) (10.0 [1.0, 19.1] estimate of difference [95% CI]).

Physical Function Response

In study PsA-I, the proportion of patients with ≥ 0.30 decrease from baseline in HAQ-DI score was 45.0% with intravenous abatacept vs 19.0% with placebo (26.1 [6.8, 45.5], estimate of difference [95% CI]) at Week 24. In study PsA-II, the proportion of patients with at least ≥ 0.35 decrease from

baseline in HAQ-DI was 31.0% with abatacept vs. 23.7% with placebo (7.2 [-1.1, 15.6], estimate of difference [95% CI]). Improvement in HAQ-DI scores was maintained or improved for up to 1 year with continuing abatacept treatment in both PsA-I and PsA-II studies.

No significant changes in PASI scores with abatacept treatment were seen over the 24-week double-blind period. Patients entering the two PsA studies had mild to moderate psoriasis with median PASI scores of 8.6 in PsA-I and 4.5 in PsA-II. In study PsA-I, the proportions of patients achieving PASI 50 response was 28.6% with abatacept vs. 14.3% with placebo (14.3 [-15.3, 43.9], estimate of difference [95% CI]), and the proportion of patients who achieved PASI 75 response was 14.3% with abatacept vs. 4.8% with placebo (9.5 [-13.0, 32.0], estimate of difference [95% CI]). In study PsA-II, the proportion of patients who achieved PASI 50 response was 26.7% with abatacept vs. 19.6% with placebo (7.3 [-2.2, 16.7], estimate of difference [95% CI]), and the proportion of patients who achieved PASI 75 response was 16.4% with abatacept vs. 10.1% with placebo (6.4 [-1.3, 14.1], estimate of difference [95% CI]).

Paediatric population in polyarticular juvenile idiopathic arthritis

Subcutaneous

The efficacy of subcutaneous abatacept in children 2 to 17 years of age is based on pharmacokinetic exposure and extrapolation of established efficacy from intravenous abatacept in pJIA patients and subcutaneous abatacept in adult patients with RA, and is supported by data from an ongoing clinical study. In this study children and adolescents with moderately to severely active pJIA, ages 2 to 17 years (46 patients in the 2 to 5 year age cohort and 173 patients in the 6 to 17 year age cohort) with an inadequate response or intolerance to at least one DMARD, which may have included biologic agents, were treated. The safety and efficacy of subcutaneous abatacept were assessed in a single-arm, open-label study designed with a primary endpoint of steady-state trough concentration (C_{min}) at 4 months (short-term period) in the 6 to 17 year age cohort. Patients continued abatacept treatment in an ongoing open-label extension, which assessed long-term safety and efficacy for an additional 20 months.

At baseline 79% of 219 patients enrolled and treated in the study were taking methotrexate (mean dose at study entry, 12.3 mg/m²/week) and 21% of patients received abatacept monotherapy. Of the 219 patients entering the study, 56 (25.6%) had previously been treated with biologic DMARD therapy (including TNF inhibitors and tocilizumab).

Patients entered in the trial were a mean 10.6 years of age with mean disease duration of 2.4 years. They had active disease, with a mean active joint count of 11.8, mean number of joints with loss of motion of 10.3, and a mean elevated C-reactive protein (CRP) level of 1.24 mg/dL at baseline.

Of the 219 patients treated, 205 completed the short-term period and 200 entered the ongoing long-term extension period. In the 2 to 5 year age cohort, 39 (84.8%) patients completed 2 years. In the 6 to 17 year age cohort 132 (76.3%) patients completed 2 years.

Response rates at the end of the short-term exposure are summarised in Table 9:

Table 9: Proportion (%) of polyarticular JIA patients with ACRP responses or inactive disease at end of short-term period (4 months)

	Ages 2 to 17 years
	n = 219
ACRP30	84.5%
ACRP50	75.3%
ACRP70	57.1%
ACRP90	34.7%
ACRP100	20.1%
Inactive disease*	34.2%

* No active joints, physician's global assessment of disease severity ≤ 10 mm and CRP ≤ 0.6 mg/dL.

The ACRP responses and inactive disease results were maintained through 2 years.

Intravenous

Children and adolescents with moderate to severe active pJIA, ages 6 to 17 years with an inadequate response or intolerance to at least one DMARD, which may have included biologic agents, were enrolled. The safety and efficacy of intravenous abatacept were assessed in a three-part study. Period A was a 4-month open-label lead-in designed to induce an ACR Pedi 30 response. Patients achieving at least a ACR Pedi 30 response at the end of Period A were randomised into a double-blind, withdrawal phase (Period B), and received either abatacept or placebo for 6 months or until pJIA disease flare as defined in the study. Unless they had discontinued due to safety reasons, all patients who completed, or had a flare during Period B or were non-responders in Period A were offered entry into Period C, the open-label extension, which assessed long-term safety and efficacy.

In Period A all patients received 10 mg/kg of abatacept on days 1, 15, 29, 57 and 85 and were assessed on day 113. During period A, 74% were taking methotrexate (mean dose at study entry, 13.2 mg/m²/week) thus, 26% of patients received abatacept monotherapy in Period A. Of the 190 patients entering the study, 57 (30%) had previously been treated with TNF-inhibitor therapy.

ACR Pedi 30 responders at the end of Period A were randomised into Period B, the double-blind, withdrawal phase, to receive either abatacept or placebo for 6 months or until JIA flare.

Flare was defined as:

- $\geq 30\%$ worsening in at least 3 of the 6 pJIA core set variables
- $\geq 30\%$ improvement in not more than 1 of the 6 pJIA core set variables
- ≥ 2 cm (possible up to 10 cm) of worsening must have been present if the Physician or Parent Global Assessment was used to define flare
- worsening in ≥ 2 joints must have been present if the number of active joints or joints with limited range of motion was used to define flare

The patients entered in the trial were a mean of 12.4 years of age with mean disease duration of 4.4 years. They had active disease, with baseline mean active joint count of 16 and a mean number of joints with loss of motion of 16; and elevated C-reactive protein (CRP) levels (mean, 3.2 mg/dL) and ESRs (mean, 32 mm/h). Their pJIA subtypes at disease onset were: oligoarticular (16%), polyarticular (64%; 20% of the total were rheumatoid factor positive), and systemic (20%).

Of the 190 patients enrolled, 170 completed Period A, 65% (123/190) achieved an ACR Pedi 30 response, and 122 were randomised to Period B. Responses were similar in all subtypes of pJIA studied and for patients with or without methotrexate use. Of the 133 (70%) patients with no prior TNF-inhibitor therapy, 101 (76%) achieved at least an ACR Pedi 30 response; of the 57 patients who had received prior TNF-inhibitor therapy, 22 (39%) achieved at least an ACR Pedi 30 response.

During Period B, the time to disease flare for the patients randomised to placebo was significantly shorter than for those randomised to abatacept (primary endpoint, $p = 0.0002$; log-rank test).

Significantly more placebo recipients flared during Period B (33/62; 53%) than those maintained on abatacept (12/60; 20%; chi-square $p < 0.001$). The risk of disease flare for patients continuing on abatacept was less than one third that for placebo-treated patients (hazard ratio estimate = 0.31; 95% CI 0.16, 0.59).

Most randomised Period B patients entered Period C (58/60 Period B abatacept recipients; 59/62 Period B placebo recipients), as did 36 of the 47 Period A non-responders ($n = 153$ total patients).

Response rates at the end of Period A, at the end of Period B and after 5 years exposure in Period C are summarised in Table 10:

Table 10: Proportion (%) of polyarticular JIA patients with ACR responses or inactive disease

	End of Period A (day 113)	End of Period B ^a (day 169)		Period C ^b (day 1765)		
	Abatacept n = 190	Abatacept n = 58	Placebo n = 59	Abatacept group in Period B n = 33	Placebo group in Period B n = 30	Non-responder in Period A n = 13
ACR30	65	85	68	97	87	69
ACR50	50	79	53	94	80	69
ACR70	28	55	31	79	63	54
ACR90	13	41	15	67	40	39
Inactive disease	Not assessed	31	10	52	33	31

^a day 169 Last Observation Carried Forward (LOCF) for patients treated in Period C

^b As observed

Participants in Period C at day 1765 included 33 of the 58 Period B abatacept recipients, 30 of the 59 Period B placebo recipients, and 13 of the 36 Period A non-responders. The median duration of abatacept treatment in Period C was 1815 days (range 57–2,415 days; nearly 61 months). One hundred and two (67%) of the subjects had received at least 1,080 days (~ 36 months) of abatacept therapy in Period C. All patients had at least 4 months of prior, open-label abatacept treatment in Period A.

5.2 Pharmacokinetic properties

Adult rheumatoid arthritis

The geometric mean estimate (90% confidence interval) for the bioavailability of abatacept following subcutaneous administration relative to intravenous administration is 78.6% (64.7%, 95.6%). The mean (range) for c_{min} and c_{max} at steady state observed after 85 days of treatment was 32.5 mcg/mL (6.6 to 113.8 mcg/mL) and 48.1 mcg/mL (9.8 to 132.4 mcg/mL), respectively. Mean estimates for systemic clearance (0.28 mL/h/kg), volume of distribution (0.11 L/kg), and terminal half-life (14.3 days) were comparable between subcutaneous and intravenous administration.

A single study was conducted to determine the effect of monotherapy use of abatacept on immunogenicity following subcutaneous administration without an intravenous load. When the intravenous loading dose was not administered, a mean trough concentration of 12.6 mcg/mL was achieved after 2 weeks of dosing. The efficacy response over time in this study appeared consistent with studies that included an intravenous loading dose, however, the effect of no intravenous load on the onset of efficacy has not been formally studied.

Consistent with the intravenous data, population pharmacokinetic analyses for subcutaneous abatacept in RA patients revealed that there was a trend toward higher clearance of abatacept with increasing

body weight. Age and gender (when corrected for body weight) did not affect apparent clearance. Concomitant MTX, NSAIDs, corticosteroids, and TNF-inhibitors did not influence abatacept apparent clearance.

Adult psoriatic arthritis

In PsA-I, patients were randomised to receive intravenous placebo or abatacept 3 mg/kg (3/3 mg/kg), 10 mg/kg (10/10 mg/kg), or two doses of 30 mg/kg followed by 10 mg/kg (30/10 mg/kg), on day 1, 15, 29, and then every 28 days thereafter. In this study, the steady-state concentrations of abatacept were dose-related. The geometric mean (CV%) c_{\min} at day 169 were 7.8 mcg/mL (56.3%) for the 3/3 mg/kg, 24.3 mcg/mL (40.8%) for 10/10 mg/kg, and 26.6 mcg/mL (39.0%) for the 30/10 mg/kg regimens.

In study PsA-II following weekly subcutaneous administration of abatacept at 125 mg, steady-state of abatacept was reached at day 57 with the geometric mean (CV%) c_{\min} ranging from 22.3 (54.2%) to 25.6 (47.7%) mcg/mL on days 57 to 169, respectively.

Consistent with the results observed earlier in RA patients, population pharmacokinetic analyses for abatacept in PsA patients revealed that there was a trend toward higher clearance (L/h) of abatacept with increasing body weight.

Paediatric pJIA population

Pharmacokinetics of abatacept for subcutaneous injection have been studied in patients 2 to 17 years of age.

Steady state of abatacept was achieved by day 85 following the weekly body-weight-tiered subcutaneous abatacept dosing. Comparable trough concentrations across weight tiers and age groups were achieved by the body-weight-tiered subcutaneous dosing regimen. The mean (range) trough concentration of abatacept at day 113 was 46.2 mcg/mL (13.4 to 96.2 mcg/mL), 48.0 mcg/mL (22.4 to 122.1 mcg/mL), and 38.5 mcg/mL (9.3 to 73.2 mcg/mL) in paediatric pJIA patients weighing 10 to < 25 kg, 25 to < 50 kg, and \geq 50 kg, respectively.

The pharmacokinetics of abatacept is similar in adult RA and paediatric pJIA patients except for the higher SC absorption in pJIA patients. SC bioavailability (F) increased by 28% and the absorption rate constant (KA) was higher in pJIA patients than RA patients.

Consistent with the intravenous data, population pharmacokinetic analyses for subcutaneous abatacept in pJIA patients revealed that there was a trend toward higher clearance of abatacept with increasing body weight. Age and gender (when corrected for body weight) did not affect apparent clearance. Concomitant medication, such as methotrexate, corticosteroids, and NSAIDs, did not influence abatacept apparent clearance.

5.3 Preclinical safety data

No mutagenicity or clastogenicity was observed with abatacept in a battery of *in vitro* studies. In a mouse carcinogenicity study, increases in the incidence of malignant lymphomas and mammary gland tumours (in females) occurred. The increased incidence of lymphomas and mammary tumours observed in mice treated with abatacept may have been associated with decreased control of murine leukaemia virus and mouse mammary tumour virus, respectively, in the presence of long-term immunomodulation. In a one-year toxicity study in cynomolgus monkeys, abatacept was not associated with any significant toxicity. Reversible pharmacological effects consisted of minimal transient decreases in serum IgG and minimal to severe lymphoid depletion of germinal centres in the spleen and/or lymph nodes. No evidence of lymphomas or preneoplastic morphological changes was observed, despite the presence of a virus, lymphocryptovirus, which is known to cause such lesions in immunosuppressed monkeys within the time frame of this study. The relevance of these findings to the clinical use of abatacept is unknown.

In rats, abatacept had no undesirable effects on male or female fertility. Embryo-foetal development studies were conducted with abatacept in mice, rats, and rabbits at doses up to 20 to 30 times a human 10 mg/kg dose and no undesirable effects were observed in the offspring. In rats and rabbits, abatacept exposure was up to 29-fold a human 10 mg/kg exposure based on AUC. Abatacept was shown to cross the placenta in rats and rabbits. In a pre- and postnatal development study with abatacept in rats, no undesirable effects were observed in pups of dams given abatacept at doses up to 45 mg/kg, representing 3-fold a human 10 mg/kg exposure based on AUC. At a dose of 200 mg/kg, representing 11-fold a human exposure at 10 mg/kg based on AUC, limited changes in immune function (a 9-fold increase in the mean T-cell-dependent antibody response in female pups and inflammation of the thyroid of 1 female pup out of 10 male and 10 female pups evaluated at this dose) were observed.

Non-clinical studies relevant for use in the paediatric population

Studies in rats exposed to abatacept have shown immune system abnormalities including a low incidence of infections leading to death (juvenile rats). In addition, inflammation of the thyroid and pancreas was frequently seen in both juvenile and adult rats exposed to abatacept. Juvenile rats seemed to be more sensitive to lymphocytic inflammation of thyroid. Studies in adult mice and monkeys have not demonstrated similar findings. It is likely that the increased susceptibility to opportunistic infections observed in juvenile rats is associated with the exposure to abatacept before development of memory responses. The relevance of these results to humans is unknown.

6. PHARMACEUTICAL PARTICULARS

6.1 List of excipients

Sucrose
Poloxamer 188
Sodium dihydrogen phosphate monohydrate
Disodium phosphate anhydrous
Water for injections

6.2 Incompatibilities

In the absence of compatibility studies, this medicinal product must not be mixed with other medicinal products.

6.3 Shelf life

2 years

6.4 Special precautions for storage

Store in a refrigerator (2°C - 8°C). Do not freeze.
Store in the original package in order to protect from light.

6.5 Nature and contents of container

ORENCIA 50 mg solution for injection in pre-filled syringe

0.4 mL pre-filled syringe (type 1 glass) with an automatic needle safety guard and flange extenders (white plunger).
Packs of 4 pre-filled syringes with needle guard.

ORENCIA 87.5 mg solution for injection in pre-filled syringe

0.7 mL pre-filled syringe (type 1 glass) with an automatic needle safety guard and flange extenders (light blue plunger).

Packs of 4 pre-filled syringes with needle guard.

ORENCIA 125 mg solution for injection in pre-filled syringe

One mL pre-filled syringe (type 1 glass) with flange extenders or one mL pre-filled syringe with an automatic needle safety guard and flange extenders (orange plunger).

Packs of 1 or 4 pre-filled syringes and multipack containing 12 pre-filled syringes (3 packs of 4).

Packs of 1, 3 or 4 pre-filled syringes with needle guard and multipack containing 12 pre-filled syringes with needle guard (3 packs of 4).

The type 1 glass syringe has a coated bromobutyl stopper and fixed stainless steel needle covered with a rigid needle shield.

Not all pack sizes may be marketed.

6.6 Special precautions for disposal and other handling

The medicinal product is for single use only. After removing the pre-filled syringe from the refrigerator the pre-filled syringe should be allowed to reach room temperature by waiting 30 minutes, before injecting ORENCIA. The syringe should not be shaken.

Any unused medicinal product or waste material should be disposed of in accordance with local requirements.

7. MARKETING AUTHORISATION HOLDER

Bristol-Myers Squibb Pharma EEIG
Plaza 254
Blanchardstown Corporate Park 2
Dublin 15, D15 T867
Ireland

8. MARKETING AUTHORISATION NUMBERS

EU/1/07/389/004-010

EU/1/07/389/013-014

9. DATE OF FIRST AUTHORISATION/RENEWAL OF THE AUTHORISATION

Date of first authorisation: 21 May 2007

Date of latest renewal: 21 May 2012

10. DATE OF REVISION OF THE TEXT

Detailed information on this medicinal product is available on the website of the European Medicines Agency <http://www.ema.europa.eu>.

1. NAME OF THE MEDICINAL PRODUCT

ORENCIA 125 mg solution for injection in pre-filled pen

2. QUALITATIVE AND QUANTITATIVE COMPOSITION

Each pre-filled pen contains 125 mg of abatacept in one mL.

Abatacept is a fusion protein produced by recombinant DNA technology in Chinese hamster ovary cells.

For the full list of excipients, see section 6.1.

3. PHARMACEUTICAL FORM

Solution for injection (injection) in pre-filled pen (ClickJect).

The solution is clear, colourless to pale yellow with a pH of 6.8 to 7.4.

4. CLINICAL PARTICULARS

4.1 Therapeutic indications

Rheumatoid arthritis

ORENCIA, in combination with methotrexate, is indicated for:

- the treatment of moderate to severe active rheumatoid arthritis (RA) in adult patients who responded inadequately to previous therapy with one or more disease-modifying anti-rheumatic drugs (DMARDs) including methotrexate (MTX) or a tumour necrosis factor (TNF)-alpha inhibitor.
- the treatment of highly active and progressive disease in adult patients with rheumatoid arthritis not previously treated with methotrexate.

A reduction in the progression of joint damage and improvement of physical function have been demonstrated during combination treatment with abatacept and methotrexate.

Psoriatic arthritis

ORENCIA, alone or in combination with methotrexate (MTX), is indicated for the treatment of active psoriatic arthritis (PsA) in adult patients when the response to previous DMARD therapy including MTX has been inadequate and for whom additional systemic therapy for psoriatic skin lesions is not required.

4.2 Posology and method of administration

Treatment should be initiated and supervised by specialist physicians experienced in the diagnosis and treatment of rheumatoid arthritis.

If a response to abatacept is not present within 6 months of treatment, the continuation of the treatment should be reconsidered (see section 5.1).

Posology

Rheumatoid arthritis

Adults

ORENCIA subcutaneous (SC) may be initiated with or without an intravenous (IV) loading dose. ORENCIA SC should be administered weekly at a dose of 125 mg by subcutaneous injection regardless of weight (see section 5.1). If a single IV infusion is given to initiate treatment (IV loading dose before SC administration), the first 125 mg abatacept SC should be administered within a day of the IV infusion, followed by the weekly 125 mg abatacept SC injections (for the posology of the intravenous loading dose, please refer to section 4.2 of ORENCIA 250 mg powder for concentrate for solution for infusion).

Patients switching from ORENCIA intravenous therapy to subcutaneous administration should administer the first subcutaneous dose instead of the next scheduled intravenous dose.

No dose adjustment is required when used in combination with other DMARDs, corticosteroids, salicylates, nonsteroidal anti-inflammatory drugs (NSAIDs), or analgesics.

Psoriatic arthritis

Adults

ORENCIA should be administered weekly at a dose of 125 mg by subcutaneous (SC) injection without the need for an intravenous (IV) loading dose.

Patients switching from ORENCIA intravenous therapy to subcutaneous administration should administer the first subcutaneous dose instead of the next scheduled intravenous dose.

Missed dose

If a patient misses an injection of ORENCIA and is within three days of the planned date, he/she should be instructed to take the missed dose immediately and remain on the original weekly schedule. If the dose is missed by more than three days, the patient should be instructed when to take the next dose based on medical judgment (condition of the patient, status of disease activity, etc).

Special populations

Elderly patients

No dose adjustment is required (see section 4.4).

Renal and hepatic impairment

ORENCIA has not been studied in these patient populations. No dose recommendations can be made.

Paediatric population

The safety and efficacy of ORENCIA solution for injection in pre-filled pen for subcutaneous administration in children below 18 years of age have not been established. No data are available.

ORENCIA powder for concentrate for solution for infusion is available for paediatric patients 6 years of age and older for the treatment of pJIA (see Summary of Product Characteristics for ORENCIA powder for concentrate for solution for infusion).

ORENCIA solution for injection pre-filled syringe for subcutaneous administration is available for paediatric patients 2 years of age and older for the treatment of pJIA (see Summary of Product Characteristics for ORENCIA Solution for Injection pre-filled syringe).

Method of administration

For subcutaneous use.

ORENCIA is intended for use under the guidance of a healthcare professional. After proper training in subcutaneous injection technique, a patient may self-inject with ORENCIA if a physician/healthcare professional determines that it is appropriate.

The total content (1 mL) of the pre-filled pen should be administered as a subcutaneous injection only. Injection sites should be rotated and injections should never be given into areas where the skin is tender, bruised, red, or hard.

Comprehensive instructions for the preparation and administration of ORENCIA in a pre-filled pen are given in the package leaflet and "Important instructions for use". For instructions on preparation of the medicinal product before administration, see section 6.6.

4.3 Contraindications

Hypersensitivity to the active substance or to any of the excipients listed in section 6.1.

Severe and uncontrolled infections such as sepsis and opportunistic infections (see section 4.4).

4.4 Special warnings and precautions for use

Combination with TNF-inhibitors

There is limited experience with use of abatacept in combination with TNF-inhibitors (see section 5.1). In placebo-controlled clinical trials, in comparison with patients treated with TNF-inhibitors and placebo, patients who received combination TNF-inhibitors with abatacept experienced an increase in overall infections and serious infections (see section 4.5). Abatacept is not recommended for use in combination with TNF-inhibitors.

While transitioning from TNF-inhibitor therapy to ORENCIA therapy, patients should be monitored for signs of infection (see section 5.1, study VII).

Allergic reactions

Allergic reactions have been reported uncommonly with abatacept administration in clinical trials, where patients were not required to be pretreated to prevent allergic reactions (see section 4.8). Anaphylaxis or anaphylactoid reactions can occur after the first infusion and can be life-threatening. In post-marketing experience, a case of fatal anaphylaxis following the first infusion of ORENCIA has been reported. If any serious allergic or anaphylactic reaction occurs, intravenous or subcutaneous ORENCIA therapy should be discontinued immediately and appropriate therapy initiated, and the use of ORENCIA should be permanently discontinued (see section 4.8).

Effects on the immune system

Medicinal products which affect the immune system, including ORENCIA, may affect host defences against infections and malignancies, and affect vaccination responses.

Co-administration of ORENCIA with biologic immunosuppressive or immunomodulatory agents could potentiate the effects of abatacept on the immune system (see section 4.5).

Infections

Serious infections, including sepsis and pneumonia, have been reported with abatacept (see section 4.8). Some of these infections have been fatal. Many of the serious infections have occurred in patients on concomitant immunosuppressive therapy which in addition to their underlying disease, could further predispose them to infections. Treatment with ORENCIA should not be initiated in patients with active infections until infections are controlled. Physicians should exercise caution when considering the use of ORENCIA in patients with a history of recurrent infections or underlying conditions which may predispose them to infections. Patients who develop a new infection while

undergoing treatment with ORENCIA should be monitored closely. Administration of ORENCIA should be discontinued if a patient develops a serious infection.

No increase of tuberculosis was observed in the pivotal placebo-controlled studies; however, all ORENCIA patients were screened for tuberculosis. The safety of ORENCIA in individuals with latent tuberculosis is unknown. There have been reports of tuberculosis in patients receiving ORENCIA (see section 4.8). Patients should be screened for latent tuberculosis prior to initiating ORENCIA. The available medical guidelines should also be taken into account.

Anti-rheumatic therapies have been associated with hepatitis B reactivation. Therefore, screening for viral hepatitis should be performed in accordance with published guidelines before starting therapy with ORENCIA.

Progressive multifocal leukoencephalopathy (PML)

Cases of PML have been reported in patients receiving abatacept mostly in combination with other immunosuppressive medication. PML can be fatal and should be considered in the differential diagnosis in immunosuppressed patients with new onset or worsening neurological, psychiatric and cognitive symptoms. If symptoms suggestive of PML occur during ORENCIA therapy, treatment with ORENCIA should be discontinued and appropriate diagnostic measures initiated.

Malignancies

In the placebo-controlled clinical trials, the frequencies of malignancies in abatacept- and placebo-treated patients were 1.2% and 0.9%, respectively (see section 4.8). Patients with known malignancies were not included in these clinical trials. In carcinogenicity studies in mice, an increase in lymphomas and mammary tumours were noted. The clinical significance of this observation is unknown (see section 5.3). The potential role of abatacept in the development of malignancies, including lymphoma, in humans is unknown. There have been reports of non-melanoma skin cancers in patients receiving ORENCIA (see section 4.8). Periodic skin examination is recommended for all patients, particularly those with risk factors for skin cancer.

Vaccinations

Patients treated with ORENCIA may receive concurrent vaccinations, except for live vaccines. Live vaccines should not be given concurrently with abatacept or within 3 months of its discontinuation. Medicinal products that affect the immune system, including abatacept, may blunt the effectiveness of some immunisations (see section 4.5).

Elderly patients

A total of 404 patients 65 years of age and older, including 67 patients 75 years and older, received intravenous abatacept in placebo-controlled clinical trials. A total of 270 patients 65 years of age and older, including 46 patients 75 years and older, received subcutaneous abatacept in controlled clinical trials. The frequencies of serious infection and malignancy relative to placebo among intravenous abatacept-treated patients over age 65 were higher than among those under age 65. Similarly, the frequencies of serious infection and malignancy among subcutaneous abatacept-treated patients over age 65 were higher than among those under age 65. Because there is a higher incidence of infections and malignancies in the elderly in general, caution should be used when treating the elderly (see section 4.8).

Autoimmune processes

There is a theoretical concern that treatment with abatacept might increase the risk for autoimmune processes in adults, for example deterioration of multiple sclerosis. In the placebo-controlled clinical trials, abatacept treatment did not lead to increased autoantibody formation, such as antinuclear and anti-dsDNA antibodies, relative to placebo treatment (see sections 4.8 and 5.3).

Patients on controlled sodium diet

This medicinal product contains 0.014 mmol sodium (0.322 mg) per pre-filled pen, that is to say essentially 'sodium-free'.

Traceability

In order to improve the traceability of biological medicinal products, the name and the batch number of the administered product should be clearly recorded.

4.5 Interaction with other medicinal products and other forms of interaction

Combination with TNF-inhibitors

There is limited experience with the use of abatacept in combination with TNF-inhibitors (see section 5.1). While TNF-inhibitors did not influence abatacept clearance, in placebo-controlled clinical trials, patients receiving concomitant treatment with abatacept and TNF-inhibitors experienced more infections and serious infections than patients treated with only TNF-inhibitors. Therefore, concurrent therapy with abatacept and a TNF-inhibitor is not recommended.

Combination with other medicinal products

Population pharmacokinetic analyses did not detect any effect of methotrexate, NSAIDs, and corticosteroids on abatacept clearance (see section 5.2).

No major safety issues were identified with use of abatacept in combination with sulfasalazine, hydroxychloroquine, or leflunomide.

Combination with other medicinal products that affect the immune system and with vaccinations

Co-administration of abatacept with biologic immunosuppressive or immunomodulatory agents could potentiate the effects of abatacept on the immune system. There is insufficient evidence to assess the safety and efficacy of abatacept in combination with anakinra or rituximab (see section 4.4).

Vaccinations

Live vaccines should not be given concurrently with abatacept or within 3 months of its discontinuation. No data are available on the secondary transmission of infection from persons receiving live vaccines to patients receiving abatacept. Medicinal products that affect the immune system, including abatacept, may blunt the effectiveness of some immunisations (see sections 4.4 and 4.6).

Exploratory studies to assess the effect of abatacept on the antibody response to vaccination in healthy subjects as well as the antibody response to influenza and pneumococcal vaccines in rheumatoid arthritis patients suggested that abatacept may blunt the effectiveness of the immune response, but did not significantly inhibit the ability to develop a clinically significant or positive immune response.

Abatacept was evaluated in an open-label study in rheumatoid arthritis patients administered the 23-valent pneumococcal vaccine. After pneumococcal vaccination, 62 of 112 abatacept-treated patients were able to mount an adequate immune response of at least a 2-fold increase in antibody titers to pneumococcal polysaccharide vaccine.

Abatacept was also evaluated in an open-label study in rheumatoid arthritis patients administered the seasonal influenza trivalent virus vaccine. After influenza vaccination, 73 of 119 abatacept-treated patients without protective antibody levels at baseline were able to mount an adequate immune response of at least a 4-fold increase in antibody titers to trivalent influenza vaccine.

4.6 Fertility, pregnancy and lactation

Pregnancy and women of childbearing potential

There are no adequate data from use of abatacept in pregnant women. In pre-clinical embryo-foetal development studies no undesirable effects were observed at doses up to 29-fold a human 10 mg/kg dose based on AUC. In a pre- and postnatal development study in rats, limited changes in immune function were observed at 11-fold higher than a human 10 mg/kg dose based on AUC (see section 5.3).

ORENCIA should not be used during pregnancy unless the clinical condition of the woman requires treatment with abatacept.

Women of childbearing potential have to use effective contraception during treatment and up to 14 weeks after the last dose of abatacept.

Abatacept may cross the placenta into the serum of infants born to women treated with abatacept during pregnancy. Consequently, these infants may be at increased risk of infection. The safety of administering live vaccines to infants exposed to abatacept *in utero* is unknown. Administration of live vaccines to infants exposed to abatacept *in utero* is not recommended for 14 weeks following the mother's last exposure to abatacept during pregnancy.

Breast-feeding

Abatacept has been shown to be present in rat milk.

It is unknown whether abatacept is excreted in human milk.

A risk to the newborns/infants cannot be excluded.

Breast-feeding should be discontinued during treatment with ORENCIA and for up to 14 weeks after the last dose of abatacept treatment.

Fertility

Formal studies of the potential effect of abatacept on human fertility have not been conducted. In rats, abatacept had no undesirable effects on male or female fertility (see section 5.3).

4.7 Effects on ability to drive and use machines

Based on its mechanism of action, abatacept is expected to have no or negligible influence on the ability to drive and use machines. However, dizziness and reduced visual acuity have been reported as common and uncommon adverse reactions respectively from patients treated with ORENCIA, therefore if a patient experiences such symptoms, driving and use of machinery should be avoided.

4.8 Undesirable effects

Summary of the safety profile in rheumatoid arthritis

Abatacept has been studied in patients with active rheumatoid arthritis in placebo-controlled clinical trials (2,653 patients with abatacept, 1,485 with placebo).

In placebo-controlled clinical trials with abatacept, adverse reactions (ARs) were reported in 49.4% of abatacept-treated patients and 45.8% of placebo-treated patients. The most frequently reported adverse reactions ($\geq 5\%$) among abatacept-treated patients were headache, nausea, and upper respiratory tract infections (including sinusitis). The proportion of patients who discontinued treatment due to ARs was 3.0% for abatacept-treated patients and 2.0% for placebo-treated patients.

Tabulated list of adverse reactions

Listed in Table 1 are adverse reactions observed in clinical trials and post-marketing experience presented by system organ class and frequency, using the following categories: very common ($\geq 1/10$); common ($\geq 1/100$ to $< 1/10$); uncommon ($\geq 1/1,000$ to $< 1/100$); rare ($\geq 1/10,000$ to $< 1/1,000$); very rare ($< 1/10,000$). Within each frequency grouping, undesirable effects are presented in order of decreasing seriousness.

Table 1: Adverse reactions

Infections and infestations	Very Common	Upper respiratory tract infection (including tracheitis, nasopharyngitis, and sinusitis)
	Common	Lower respiratory tract infection (including bronchitis), urinary tract infection, herpes infections (including herpes simplex, oral herpes, and herpes zoster), pneumonia, influenza
	Uncommon	Tooth infection, onychomycosis, sepsis, musculoskeletal infections, skin abscess, pyelonephritis, rhinitis, ear infection
	Rare	Tuberculosis, bacteraemia, gastrointestinal infection, pelvic inflammatory disease
Neoplasms benign, malignant and unspecified (incl. cysts and polyps)	Uncommon	Basal cell carcinoma, skin papilloma
	Rare	Lymphoma, lung neoplasm malignant, squamous cell carcinoma
Blood and lymphatic system disorders	Uncommon	Thrombocytopenia, leukopenia
Immune system disorders	Uncommon	Hypersensitivity
Psychiatric disorders	Uncommon	Depression, anxiety, sleep disorder (including insomnia)
Nervous system disorders	Common	Headache, dizziness
	Uncommon	Migraine, paraesthesia
Eye disorders	Uncommon	Conjunctivitis, dry eye, visual acuity reduced
Ear and labyrinth disorders	Uncommon	Vertigo
Cardiac disorders	Uncommon	Palpitations, tachycardia, bradycardia

Vascular disorders	Common	Hypertension, blood pressure increased
	Uncommon	Hypotension, hot flush, flushing, vasculitis, blood pressure decreased
Respiratory, thoracic and mediastinal disorders	Common	Cough
	Uncommon	Chronic obstructive pulmonary disease exacerbated, bronchospasm, wheezing, dyspnoea, throat tightness
Gastrointestinal disorders	Common	Abdominal pain, diarrhoea, nausea, dyspepsia, mouth ulceration, aphthous stomatitis, vomiting
	Uncommon	Gastritis
Hepatobiliary disorders	Common	Liver function test abnormal (including transaminases increased)
Skin and subcutaneous tissue disorders	Common	Rash (including dermatitis)
	Uncommon	Increased tendency to bruise, dry skin, alopecia, pruritus, urticaria, psoriasis, acne, erythema, hyperhidrosis
Musculoskeletal and connective tissue disorders	Uncommon	Arthralgia, pain in extremity
Reproductive system and breast disorders	Uncommon	Amenorrhea, menorrhagia
General disorders and administration site conditions	Common	Fatigue, asthenia, local injection site reactions, systemic injection reactions*
	Uncommon	Influenza like illness, weight increased

*(e.g. pruritus, throat tightness, dyspnoea)

Description of selected adverse reactions

Infections

In the placebo-controlled clinical trials with abatacept, infections at least possibly related to treatment were reported in 22.7% of abatacept-treated patients and 20.5% of placebo-treated patients.

Serious infections at least possibly related to treatment were reported in 1.5% of abatacept-treated patients and 1.1% of placebo-treated patients. The type of serious infections was similar between the abatacept and placebo treatment groups (see section 4.4).

The incidence rates (95% CI) for serious infections was 3.0 (2.3, 3.8) per 100 patient-years for abatacept-treated patients and 2.3 (1.5, 3.3) per 100 patient-years for placebo-treated patients in the double-blind studies.

In the cumulative period in clinical trials in 7,044 patients treated with abatacept during 20,510 patient-years, the incidence rate of serious infections was 2.4 per 100 patient-years, and the annualised incidence rate remained stable.

Malignancies

In placebo-controlled clinical trials, malignancies were reported in 1.2% (31/2,653) of abatacept-treated patients and in 0.9% (14/1,485) of placebo-treated patients. The incidence rates for malignancies was 1.3 (0.9, 1.9) per 100 patient-years for abatacept-treated patients and 1.1 (0.6, 1.9) per 100 patient-years for placebo-treated patients.

In the cumulative period 7,044 patients treated with abatacept during 21,011 patient-years (of which over 1,000 were treated with abatacept for over 5 years), the incidence rate of malignancy was 1.2 (1.1, 1.4) per 100 patient-years, and the annualised incidence rates remained stable.

The most frequently reported malignancy in the placebo-controlled clinical trials was non-melanoma skin cancer; 0.6 (0.3, 1.0) per 100 patient-years for abatacept-treated patients and 0.4 (0.1, 0.9) per 100 patient-years for placebo-treated patients and 0.5 (0.4, 0.6) per 100 patient-years in the cumulative period.

The most frequently reported organ cancer in the placebo-controlled clinical trials was lung cancer 0.17 (0.05, 0.43) per 100 patient-years for abatacept-treated patients, 0 for placebo-treated patients, and 0.12 (0.08, 0.17) per 100 patient-years in the cumulative period. The most common hematologic malignancy was lymphoma 0.04 (0, 0.24) per 100 patient-years for abatacept-treated patients, 0 for placebo-treated patients, and 0.06 (0.03, 0.1) per 100 patient-years in the cumulative period.

Adverse reactions in patients with chronic obstructive pulmonary disease (COPD)

In study IV, there were 37 patients with COPD treated with intravenous abatacept and 17 treated with placebo. The COPD patients treated with abatacept developed adverse reactions more frequently than those treated with placebo (51.4% vs. 47.1%, respectively). Respiratory disorders occurred more frequently in abatacept-treated patients than in placebo-treated patients (10.8% vs. 5.9%, respectively); these included COPD exacerbation, and dyspnoea. A greater percentage of abatacept- than placebo-treated patients with COPD developed a serious adverse reaction (5.4% vs. 0%), including COPD exacerbation (1 of 37 patients [2.7%]) and bronchitis (1 of 37 patients [2.7%]).

Autoimmune processes

Abatacept therapy did not lead to increased formation of autoantibodies, i.e., antinuclear and anti-dsDNA antibodies, compared with placebo.

The incidence rate of autoimmune disorders in abatacept-treated patients during the double-blind period was 8.8 (7.6, 10.1) per 100 person-years of exposure and for placebo-treated patients was 9.6 (7.9, 11.5) per 100 person-years of exposure. The incidence rate in abatacept-treated patients was 3.8 per 100 person-years in the cumulative period. The most frequently reported autoimmune-related disorders other than the indication being studied during the cumulative period were psoriasis, rheumatoid nodule, and Sjogren's syndrome.

Immunogenicity in adults treated with intravenous abatacept

Antibodies directed against the abatacept molecule were assessed by ELISA assays in 3,985 rheumatoid arthritis patients treated for up to 8 years with abatacept. One hundred and eighty-seven of 3,877 (4.8%) patients developed anti-abatacept antibodies while on treatment. In patients assessed for anti-abatacept antibodies after discontinuation of abatacept (> 42 days after last dose), 103 of 1,888 (5.5%) were seropositive.

Samples with confirmed binding activity to CTLA-4 were assessed for the presence of neutralizing antibodies. Twenty-two of 48 evaluable patients showed significant neutralizing activity. The potential clinical relevance of neutralizing antibody formation is not known.

Overall, there was no apparent correlation of antibody development to clinical response or adverse events. However, the number of patients that developed antibodies was too limited to make a definitive assessment. Because immunogenicity analyses are product-specific, comparison of antibody rates with those from other products is not appropriate.

Immunogenicity in adults treated with subcutaneous abatacept

Study SC-I compared the immunogenicity to abatacept following subcutaneous or intravenous administration as assessed by ELISA assay. During the initial double blind 6 months period (short-term period), the overall immunogenicity frequency to abatacept was 1.1% (8/725) and 2.3% (16/710) for the subcutaneous and intravenous groups, respectively. The rate is consistent with previous experience, and there was no effect of immunogenicity on pharmacokinetics, safety, or efficacy.

Immunogenicity to abatacept following long-term subcutaneous administration was assessed by a new electrochemiluminescence (ECL) assay. Comparison of incidence rates across different assays is not appropriate, as the ECL assay was developed to be more sensitive and drug tolerant than the previous ELISA assay. The cumulative immunogenicity frequency to abatacept by the ECL assay with at least one positive sample in the short-term and long-term periods combined was 15.7% (215/1369) while on abatacept, with a mean duration of exposure of 48.8 months, and 17.3% (194/1121) after discontinuation (> 21 days up to 168 days after last dose). The exposure adjusted incidence rate (expressed per 100 person-years) remained stable over the treatment duration.

Consistent with previous experience, titers and persistence of antibody responses were generally low and did not increase upon continued dosing (6.8% subjects were seropositive on 2 consecutive visits), and there was no apparent correlation of antibody development to clinical response, adverse events, or pharmacokinetics.

In study SC-III, similar immunogenicity rates were seen in patients on treatment for the abatacept+MTX, and abatacept monotherapy groups (2.9% (3/103) and 5.0% (5/101), respectively) during the double-blind 12-month period. As in study SC-I, there was no effect of immunogenicity on safety or efficacy.

Immunogenicity and safety of abatacept upon withdrawal and restart of treatment

A study in the subcutaneous program was conducted to investigate the effect of withdrawal (three months) and restart of abatacept subcutaneous treatment on immunogenicity. Upon withdrawal of abatacept subcutaneous treatment, the increased rate of immunogenicity was consistent with that seen upon discontinuation of abatacept administered intravenously. Upon reinitiating therapy, there were no injection reactions and no other safety concerns in patients who were withdrawn from subcutaneous therapy for up to 3 months relative to those who remained on subcutaneous therapy, whether therapy was reintroduced with or without an intravenous loading dose. The safety observed in the treatment arm that reinitiated therapy without an intravenous loading dose was also consistent with that observed in the other studies.

In SC-III, increased rates of immunogenicity were observed in subjects tested during 6 months of complete drug withdrawal in the abatacept+MTX and abatacept monotherapy groups (37.7% [29/77] and 44.1% [27/59], respectively) with generally low titer antibody responses. No clinical impact of these antibody responses was detected, and no safety concerns were observed upon reinitiation of abatacept therapy.

Injection Reactions in adult patients treated with subcutaneous abatacept

Study SC-I compared the safety of abatacept including injection site reactions following subcutaneous or intravenous administration. The overall frequency of injection site reactions was 2.6% (19/736) and 2.5% (18/721) for the subcutaneous abatacept group and the subcutaneous placebo group (intravenous abatacept), respectively. All injection site reactions were described as mild to moderate (hematoma, pruritus, or erythema) and generally did not necessitate drug discontinuation. During the cumulative study period when all subjects treated with abatacept in 7 SC studies were included the frequency of injection site reactions was 4.6% (116/2,538) with an incidence rate of 1.32 per 100 person-years. Postmarketing reports of systemic injection reactions (e.g. pruritus, throat tightness, dyspnoea) have been received following the use of subcutaneous ORENCIA.

Safety information related to the pharmacological class

Abatacept is the first selective co-stimulation modulator. Information on the relative safety in a clinical trial versus infliximab is summarised in section 5.1.

Summary of the safety profile in psoriatic arthritis

Abatacept has been studied in patients with active psoriatic arthritis in two placebo-controlled clinical trials (341 patients with abatacept, 253 patients with placebo) (see Section 5.1). During the 24-week placebo-controlled period in the larger study PsA-II, the proportion of patients with adverse reactions was similar in the abatacept and placebo treatment groups (15.5% and 11.4%, respectively). There were no adverse reactions that occurred at $\geq 2\%$ in either treatment group during the 24-week placebo-controlled period. The overall safety profile was comparable between studies PsA-I and PsA-II and consistent with the safety profile in rheumatoid arthritis (Table 1).

Reporting of suspected adverse reactions

Reporting suspected adverse reactions after authorisation of the medicinal product is important. It allows continued monitoring of the benefit/risk balance of the medicinal product. Healthcare professionals are asked to report any suspected adverse reactions via [the national reporting system listed in Appendix V](#).

4.9 Overdose

Doses up to 50 mg/kg have been administered intravenously without apparent toxic effect. In case of overdose, it is recommended that the patient be monitored for any signs or symptoms of adverse reactions and appropriate symptomatic treatment instituted.

5. PHARMACOLOGICAL PROPERTIES

5.1 Pharmacodynamic properties

Pharmacotherapeutic group: Immunosuppressants, selective immunosuppressants, ATC code: L04AA24

Abatacept is a fusion protein that consists of the extracellular domain of human cytotoxic T-lymphocyte-associated antigen 4 (CTLA-4) linked to a modified Fc portion of human immunoglobulin G1 (IgG1). Abatacept is produced by recombinant DNA technology in Chinese hamster ovary cells.

Mechanism of action

Abatacept selectively modulates a key costimulatory signal required for full activation of T lymphocytes expressing CD28. Full activation of T lymphocytes requires two signals provided by antigen presenting cells: recognition of a specific antigen by a T cell receptor (signal 1) and a second, costimulatory signal. A major costimulatory pathway involves the binding of CD80 and CD86 molecules on the surface of antigen presenting cells to the CD28 receptor on T lymphocytes (signal 2). Abatacept selectively inhibits this costimulatory pathway by specifically binding to CD80 and CD86. Studies indicate that naive T lymphocyte responses are more affected by abatacept than memory T lymphocyte responses.

Studies *in vitro* and in animal models demonstrate that abatacept modulates T lymphocyte-dependent antibody responses and inflammation. *In vitro*, abatacept attenuates human T lymphocyte activation as measured by decreased proliferation and cytokine production. Abatacept decreases antigen specific TNF α , interferon- γ , and interleukin-2 production by T lymphocytes.

Pharmacodynamic effects

Dose-dependent reductions were observed with abatacept in serum levels of soluble interleukin-2 receptor, a marker of T lymphocyte activation; serum interleukin-6, a product of activated synovial macrophages and fibroblast-like synoviocytes in rheumatoid arthritis; rheumatoid factor, an autoantibody produced by plasma cells; and C-reactive protein, an acute phase reactant of inflammation. In addition, serum levels of matrix metalloproteinase-3, which produces cartilage destruction and tissue remodelling, were decreased. Reductions in serum TNF α were also observed.

Clinical efficacy and safety in adult rheumatoid arthritis

The efficacy and safety of intravenous abatacept were assessed in randomised, double-blind, placebo-controlled clinical trials in adult patients with active rheumatoid arthritis diagnosed according to American College of Rheumatology (ACR) criteria. Studies I, II, III, V, and VI required patients to have at least 12 tender and 10 swollen joints at randomisation. Study IV did not require any specific number of tender or swollen joints. Study SC-I was a randomised, double-blind, double-dummy non-inferiority study administered to patients stratified by body weight (< 60 kg, 60 to 100 kg, > 100 kg) that compared the efficacy and safety of abatacept administered subcutaneously and intravenously in subjects with rheumatoid arthritis (RA), receiving background methotrexate (MTX), and experiencing an inadequate response to MTX (MTX-IR).

In studies I, II, and V the efficacy and safety of abatacept compared to placebo were assessed in patients with an inadequate response to methotrexate and who continued on their stable dose of methotrexate. In addition, study V investigated the safety and efficacy of abatacept or infliximab relative to placebo. In study III the efficacy and safety of abatacept were assessed in patients with an inadequate response to a TNF-inhibitor, with the TNF-inhibitor discontinued prior to randomisation; other DMARDs were permitted. Study IV primarily assessed safety in patients with active rheumatoid arthritis requiring additional intervention in spite of current therapy with non-biological and/or biological DMARDs; all DMARDs used at enrollment were continued. In study VI, the efficacy and safety of abatacept were assessed in methotrexate-naïve, Rheumatoid Factor (RF) and/or anti-Cyclic Citrullinated Peptide 2 (Anti-CCP2)-positive patients with early, erosive rheumatoid arthritis (≤ 2 years disease duration) who were randomised to receive abatacept plus methotrexate or methotrexate plus placebo. In study SC-I, the goal was to demonstrate non-inferiority of the efficacy and comparability of the safety of abatacept subcutaneous relative to intravenous administration in subjects with moderate to severely active RA and experiencing inadequate response to MTX. Study SC-II investigated the relative efficacy and safety of abatacept and adalimumab, both given subcutaneously without an intravenous loading dose and with background MTX, in patients with moderate to severely active RA and an inadequate response to previous MTX therapy. In study SC-III, abatacept subcutaneous was evaluated in combination with methotrexate, or as abatacept monotherapy, and compared to MTX monotherapy in induction of remission following 12 months of treatment, and the possible maintenance of drug-free remission after complete drug withdrawal, in adult MTX-naïve patients with highly active early rheumatoid arthritis (mean DAS28-CRP of 5.4; mean symptom duration less than 6.7 months) with poor prognostic factors for rapidly progressive disease (e.g. anti-citrullinated protein antibodies [ACPA+], as measured by anti-CCP2 assay, and/or RF+, baseline joint erosions).

Study I patients were randomised to receive abatacept 2 or 10 mg/kg or placebo for 12 months. Study II, III, IV, and VI patients were randomised to receive a fixed dose approximating 10 mg/kg of abatacept or placebo for 12 (studies II, IV, and VI) or 6 months (study III). The dose of abatacept was 500 mg for patients weighing less than 60 kg, 750 mg for patients weighing 60 to 100 kg, and 1,000 mg for patients weighing greater than 100 kg. In study SC-I, abatacept was given subcutaneously to patients after a single loading dose of intravenous abatacept and then every week thereafter. Subjects continued taking their current dose of MTX from the day of randomisation. Study V patients were randomised to receive this same fixed dose of abatacept or 3 mg/kg infliximab or placebo for 6 months. Study V continued for an additional 6 months with the abatacept and infliximab groups only.

Studies I, II, III, IV, V, VI, SC-I, SC-II, and SC-III evaluated 339, 638, 389, 1441, 431, 509, 1371, 646, and 351 adult patients, respectively.

Clinical response

ACR response

The percent of abatacept-treated patients achieving ACR 20, 50, and 70 responses in study II (patients with inadequate response to methotrexate), study III (patients with inadequate response to TNF-inhibitor), study VI (methotrexate-naïve patients), and study SC-I (subcutaneous abatacept) are shown in Table 2.

In abatacept-treated patients in studies II and III, statistically significant improvement in the ACR 20 response versus placebo was observed after administration of the first dose (day 15), and this improvement remained significant for the duration of the studies. In study VI, statistically significant improvement in the ACR 20 response in abatacept plus methotrexate-treated patients versus methotrexate plus placebo-treated patients was observed at 29 days, and was maintained through the duration of the study. In study II, 43% of the patients who had not achieved an ACR 20 response at 6 months developed an ACR 20 response at 12 months.

In study SC-I, abatacept administered subcutaneously (SC) was non-inferior relative to intravenous (IV) infusions of abatacept with respect to ACR 20 responses up to 6 months of treatment. Patients treated with abatacept subcutaneously also achieved similar ACR 50 and 70 responses as those patients receiving abatacept intravenously at 6 months.

No difference in clinical response between subcutaneous and intravenous abatacept was seen across the 3 weight groups. In SC-I, the ACR 20 response rates at day 169 for subcutaneous and intravenous abatacept were respectively 78.3% (472/603 SC) and 76.0% (456/600 IV) in patients < 65 years, versus 61.1% (55/90 SC) and 74.4% (58/78 IV) for patients ≥ 65 years.

Table 2: Clinical responses in controlled trials

Response Rate	Percent of patients							
	Intravenous administration						Subcutaneous administration	
	MTX-Naïve		Inadequate response to MTX		Inadequate response to TNF Inhibitor		Inadequate response to MTX	
	Study VI		Study II		Study III		Study SC-I	
	Abatacept ^a +MTX n = 256	Placebo +MTX n = 253	Abatacept ^a +MTX n = 424	Placebo +MTX n = 214	Abatacept ^a +DMARDs ^b n = 256	Placebo +DMARDs ^b n = 133	Abatacept ^f SC +MTX n = 693	Abatacept ^f IV +MTX n = 678
ACR 20								
Day 15	24%	18%	23%*	14%	18%**	5%	25%	25%
Month 3	64% ^{††}	53%	62%***	37%	46%***	18%	68%	69%
Month 6	75% [†]	62%	68%***	40%	50%***	20%	76% [§]	76%
Month 12	76% [‡]	62%	73%***	40%	NA ^d	NA ^d	NA	NA
ACR 50								
Month 3	40% [‡]	23%	32%***	8%	18%**	6%	33%	39%
Month 6	53% [‡]	38%	40%***	17%	20%***	4%	52%	50%
Month 12	57% [‡]	42%	48%***	18%	NA ^d	NA ^d	NA	NA

Percent of patients								
	Intravenous administration						Subcutaneous administration	
	MTX-Naive		Inadequate response to MTX		Inadequate response to TNF Inhibitor		Inadequate response to MTX	
	Study VI		Study II		Study III		Study SC-I	
ACR 70								
Month 3	19% [†]	10%	13%***	3%	6% ^{††}	1%	13%	16%
Month 6	32% [†]	20%	20%***	7%	10%**	2%	26%	25%
Month 12	43% [‡]	27%	29%***	6%	NA ^d	NA ^d	NA	NA
Major Clinical Response^c	27% [‡]	12%	14%***	2%	NA ^d	NA ^d	NA	NA
DAS28-CRP Remission^e								
Month 6	28% [‡]	15%	NA	NA	NA	NA	24% ^{§§}	25%
Month 12	41% [‡]	23%	NA	NA	NA	NA	NA	NA

* p < 0.05, abatacept vs. placebo.

** p < 0.01, abatacept vs. placebo.

*** p < 0.001, abatacept vs. placebo.

[†] p < 0.01, abatacept plus MTX vs. MTX plus placebo

[‡] p < 0.001, abatacept plus MTX vs. MTX plus placebo

^{††} p < 0.05, abatacept plus MTX vs. MTX plus placebo

[§] 95% CI: -4.2, 4.8 (based on prespecified margin for non-inferiority of -7.5%)

^{§§}ITT data is presented in table

^a Fixed dose approximating 10 mg/kg (see section 4.2).

^b Concurrent DMARDs included one or more of the following: methotrexate, chloroquine/hydroxychloroquine, sulfasalazine, leflunomide, azathioprine, gold, and anakinra.

^c Major clinical response is defined as achieving an ACR 70 response for a continuous 6-month period.

^d After 6 months, patients were given the opportunity to enter an open-label study.

^e DAS28-CRP Remission is defined as a DAS28-CRP score < 2.6

^f Per protocol data is presented in table. For ITT; n = 736, 721 for subcutaneous (SC) and intravenous (IV) abatacept, respectively

In the open-label extension of studies I, II, III, VI, and SC-I durable and sustained ACR 20, 50, and 70 responses have been observed through 7 years, 5 years, 5 years, 2 years, and 5 years, respectively, of abatacept treatment. In study I, ACR responses were assessed at 7 years in 43 patients with 72% ACR 20 responses, 58% ACR 50 responses, and 44% ACR 70 responses. In study II, ACR responses were assessed at 5 years in 270 patients with 84% ACR 20 responses, 61% ACR 50 responses, and 40% ACR 70 responses. In study III, ACR responses were assessed at 5 years in 91 patients with 74% ACR 20 responses, 51% ACR 50 responses, and 23% ACR 70 responses. In study VI, ACR responses were assessed at 2 years in 232 patients with 85% ACR 20 responses, 74% ACR 50 responses, and 54% ACR 70 responses. In study SC-I, ACR responses were assessed at 5 years with 85% (356/421) ACR 20 responses, 66% (277/423) ACR 50 responses, and 45% (191/425) ACR 70 responses.

Greater improvements were seen with abatacept than with placebo in other measures of rheumatoid arthritis disease activity not included in the ACR response criteria, such as morning stiffness.

DAS28 response

Disease activity was also assessed using the Disease Activity Score 28. There was a significant improvement of DAS in studies II, III, V, and VI as compared to placebo or comparator.

In study VI, which only included adults, a significantly higher proportion of patients in the abatacept plus methotrexate group (41%) achieved DAS28 (CRP)-defined remission (score < 2.6) versus the methotrexate plus placebo group (23%) at year 1. The response at year 1 in the abatacept group was maintained through year 2.

Study V: abatacept or infliximab versus placebo

A randomised, double-blind study was conducted to assess the safety and efficacy of intravenous abatacept or infliximab versus placebo in patients with an inadequate response to methotrexate (study V). The primary outcome was the mean change in disease activity in abatacept-treated patients compared to placebo-treated patients at 6 months with a subsequent double-blind assessment of safety and efficacy of abatacept and infliximab at 12 months. Greater improvement ($p < 0.001$) in DAS28 was observed with abatacept and with infliximab compared to placebo at six months in the placebo-controlled portion of the trial; the results between the abatacept and infliximab groups were similar. The ACR responses in study V were consistent with the DAS28 score. Further improvement was observed at 12 months with abatacept. At 6 months, the incidence of AE of infections were 48.1% (75), 52.1% (86), and 51.8% (57) and the incidence of serious AE of infections were 1.3% (2), 4.2% (7), and 2.7% (3) for abatacept, infliximab and placebo groups, respectively. At 12 months, the incidence of AE of infections were 59.6% (93), 68.5% (113), and the incidence of serious AE of infections were 1.9% (3) and 8.5% (14) for abatacept and infliximab groups, respectively. The open label period of the study provided an assessment of the ability of abatacept to maintain efficacy for subjects originally randomised to abatacept and the efficacy response of those subjects who were switched to abatacept following treatment with infliximab. The reduction from baseline in mean DAS28 score at day 365 (-3.06) was maintained through day 729 (-3.34) in those patients who continued with abatacept. In those patients who initially received infliximab and then switched to abatacept, the reduction in the mean DAS28 score from baseline were 3.29 at day 729 and 2.48 at day 365.

Study SC-II: abatacept versus adalimumab

A randomised, single (investigator)-blinded, non-inferiority study was conducted to assess the safety and efficacy of weekly subcutaneous (SC) abatacept without an abatacept intravenous (IV) loading dose versus every-other-weekly subcutaneous adalimumab, both with background MTX, in patients with an inadequate response to methotrexate (study SC-II). The primary endpoint showed non-inferiority (predefined margin of 12%) of ACR20 response after 12 months of treatment, 64.8% (206/318) for the abatacept SC group and 63.4% (208/328) for the adalimumab SC group; treatment difference was 1.8% [95% confidence interval (CI): -5.6, 9.2], with comparable responses throughout the 24-month period. The respective values for ACR 20 at 24 months were 59.7% (190/318) for the abatacept SC group and 60.1% (197/328) for the adalimumab SC group. The respective values for ACR 50 and ACR 70 at 12 months and 24 months were consistent and similar for abatacept and adalimumab. The adjusted mean changes (standard error; SE) from baseline in DAS28-CRP were -2.35 (SE 0.08) [95% CI: -2.51, -2.19] and -2.33 (SE 0.08) [95% CI: -2.50, -2.17] in the SC abatacept group and the adalimumab group, respectively, at 24 months, with similar changes over time. At 24 months, 50.6% (127/251) [95% CI: 44.4, 56.8] of patients in abatacept and 53.3% (130/244) [95% CI: 47.0, 59.5] of patients in adalimumab groups achieved DAS 28 < 2.6. Improvement from baseline as measured by HAQ-DI at 24 months and over time was also similar between abatacept SC and adalimumab SC.

Safety and structural damage assessments were conducted at one and two years. The overall safety profile with respect to adverse reactions was similar between the two groups over the 24-month period. After 24-months, adverse reactions were reported in 41.5% (132/318) and 50% (164/328) of abatacept and adalimumab-treated patients. Serious adverse reactions were reported in 3.5% (11/318) and 6.1% (20/328) of the respective group. At 24-months, 20.8% (66/318) of patients on abatacept and 25.3% (83/328) on adalimumab had discontinued.

In SC-II, serious infections were reported in 3.8% (12/318) of patients treated with abatacept SC weekly, none of which led to discontinuation and in 5.8% (19/328) of patients treated with adalimumab SC every-other-week, leading to 9 discontinuations in the 24-month period.

The frequency of local injection site reactions was 3.8% (12/318) and 9.1% (30/328) at 12 months ($p = 0.006$) and 4.1% (13/318) and 10.4% (34/328) at 24 months for abatacept SC and adalimumab SC, respectively. Over the 2 year study period, 3.8% (12/318) and 1.5% (5/328) patients treated with abatacept SC and adalimumab SC respectively reported autoimmune disorders mild to moderate in severity (e.g., psoriasis, Raynaud's phenomenon, erythema nodosum).

Study SC-III: Induction of remission in methotrexate-naive RA patients

A randomised and double-blinded study evaluated abatacept SC in combination with methotrexate (abatacept + MTX), abatacept SC monotherapy, or methotrexate monotherapy (MTX group) in induction of remission following 12 months of treatment, and maintenance of drug-free remission after complete drug withdrawal in MTX-naive adult patients with highly active early rheumatoid arthritis with poor prognostic factors. Complete drug withdrawal led to loss of remission (return to disease activity) in all three treatment arms (abatacept with methotrexate, abatacept or methotrexate alone) in a majority of patients (Table 3).

Table 3: Remission rates at end of drug treatment and drug withdrawal phases in study SC-III

Number of patients	Abatacept SC+ MTX n = 119	MTX n = 116	Abatacept SC n = 116
Proportion of randomised patients with induction of remission after 12 months of treatment			
DAS28-Remission ^a	60.9%	45.2%	42.5%
Odds Ratio (95% CI) vs. MTX	2.01 (1.18, 3.43)	N/A	0.92 (0.55, 1.57)
P value	0.010	N/A	N/A
SDAI Clinical Remission ^b	42.0%	25.0%	29.3%
Estimate of Difference (95% CI) vs. MTX	17.02 (4.30, 29.73)	N/A	4.31 (-7.98, 16.61)
Boolean Clinical Remission	37.0%	22.4%	26.7%
Estimate of Difference (95% CI) vs. MTX	14.56 (2.19, 26.94)	N/A	4.31 (-7.62, 16.24)
Proportion of randomised patients in remission at 12 months and at 18 months (6 months of complete drug withdrawal)			
DAS28-Remission ^a	14.8%	7.8%	12.4%
Odds Ratio (95% CI) vs. MTX	2.51 (1.02, 6.18)	N/A	2.04 (0.81, 5.14)
P value	0.045	N/A	N/A

^a DAS28-defined remission (DAS28-CRP < 2.6)

^b SDAI criterion (SDAI ≤ 3.3)

In SC-III the safety profiles of the three treatment groups (abatacept + MTX, abatacept monotherapy, MTX group) were overall similar. During the 12-month treatment period, adverse reactions were reported in 44.5% (53/119), 41.4% (48/116), and 44.0% (51/116) and serious adverse reactions were reported in 2.5% (3/119), 2.6% (3/116) and 0.9% (1/116) of patients treated in the three treatment groups, respectively. Serious infections were reported in 0.8% (1/119), 3.4% (4/116) and 0% (0/116) patients.

Radiographic response

Structural joint damage was assessed radiographically over a two-year period in studies II, VI, and SC-II. The results were measured using the Genant-modified total Sharp score (TSS) and its components, the erosion score and joint space narrowing (JSN) score.

In study II, the baseline median TSS was 31.7 in abatacept-treated patients and 33.4 in placebo-treated patients. Abatacept/methotrexate reduced the rate of progression of structural damage compared to placebo/methotrexate after 12 months of treatment as shown in Table 4. The rate of progression of structural damage in year 2 was significantly lower than that in year 1 for patients randomised to abatacept ($p < 0.0001$). Subjects entering the long term extension after 1 year of double blind treatment all received abatacept treatment and radiographic progression was investigated through year 5. Data were analysed in an as-observed analysis using mean change in total score from the previous annual visit. The mean change was, 0.41 and 0.74 from year 1 to year 2 ($n = 290, 130$), 0.37 and 0.68 from year 2 to year 3 ($n = 293, 130$), 0.34 and 0.43 from year 3 to year 4 ($n = 290, 128$) and the change was 0.26 and 0.29 ($n = 233, 114$) from year 4 to year 5 for patients originally randomised to abatacept plus MTX and placebo plus MTX respectively.

Table 4: Mean radiographic changes over 12 months in study II

Parameter	Abatacept/MTX n = 391	Placebo/MTX n = 195	P-value ^a
Total Sharp score	1.21	2.32	0.012
Erosion score	0.63	1.14	0.029
JSN score	0.58	1.18	0.009

^a Based on non-parametric analysis.

In study VI, the mean change in TSS at 12 months was significantly lower in patients treated with abatacept plus methotrexate compared to those treated with methotrexate plus placebo. At 12 months 61% (148/242) of the patients treated with abatacept plus methotrexate and 53% (128/242) of the patients treated with methotrexate plus placebo had no progression (TSS ≤ 0). The progression of structural damage was lower in patients receiving continuous abatacept plus methotrexate treatment (for 24 months) compared to patients who initially received methotrexate plus placebo (for 12 months) and were switched to abatacept plus methotrexate for the next 12 months. Among the patients who entered the open-label 12-month period, 59% (125/213) of patients receiving continuous abatacept plus methotrexate treatment and 48% (92/192) of patients who initially received methotrexate and switched to combination with abatacept had no progression.

In study SC-II, structural joint damage was assessed radiographically and expressed as a change from baseline in the van der Heijde-modified Total Sharp Score (mTSS) and its components. Similar inhibition was observed in both treatment groups up to 24 months (mTSS (mean \pm standard deviation [SD]) = 0.89 \pm 4.13 vs 1.13 \pm 8.66), erosion score (0.41 \pm 2.57 vs 0.41 \pm 5.04), and JSN score (0.48 \pm 2.18 vs 0.72 \pm 3.81)) for the abatacept ($n = 257$) and adalimumab ($n = 260$) groups, respectively.

In study SC-III, structural joint damage was assessed by MRI. The abatacept + MTX group had less progression in structural damage compared with MTX group as reflected by mean treatment difference of the abatacept + MTX group versus MTX group (Table 5).

Table 5: Structural and inflammatory MRI assessment in study SC-III

Mean Treatment Difference between Abatacept SC+MTX vs. MTX at 12 Months (95% CI)*	
MRI Erosion Score	-1.22 (-2.20, -0.25)
MRI Osteitis/Bone Oedema Score	-1.43 (-2.68, -0.18)
MRI Synovitis Score	-1.60 (-2.42, -0.78)

* $n = 119$ for Abatacept SC + MTX; $n = 116$ for MTX

Physical function response

Improvement in physical function was measured by the Health Assessment Questionnaire Disability Index (HAQ-DI) in studies II, III, IV, V, and VI and the modified HAQ-DI in study I. In study SC-I, improvement from baseline as measured by HAQ-DI at 6 months and over time was similar between subcutaneous and intravenous administration. The results from studies II, III, and VI are shown in Table 6.

Table 6: Improvement in physical function in controlled trials

	Methotrexate-Naive		Inadequate response to Methotrexate		Inadequate response to TNF Inhibitor	
	Study VI		Study II		Study III	
HAQ ^c Disability Index	Abatacept ^a +MTX	Placebo +MTX	Abatacept ^a +MTX	Placebo +MTX	Abatacept ^a +DMARDs ^b	Placebo +DMARDs ^b
Baseline (Mean)	1.7 (n = 254)	1.7 (n = 251)	1.69 (n = 422)	1.69 (n = 212)	1.83 (n = 249)	1.82 (n = 130)
Mean Improvement from Baseline						
Month 6	0.85 (n = 250)	0.68 (n = 249)	0.59*** (n = 420)	0.40 (n = 211)	0.45*** (n = 249)	0.11 (n = 130)
Month 12	0.96 (n = 254)	0.76 (n = 251)	0.66*** (n = 422)	0.37 (n = 212)	NA ^e	NA ^e
Proportion of patients with a clinically meaningful improvement ^d						
Month 6	72% [†]	63%	61%***	45%	47%***	23%
Month 12	72% [†]	62%	64%***	39%	NA ^e	NA ^e

*** p < 0.001, abatacept vs. placebo.

[†] p < 0.05, abatacept plus MTX vs MTX plus placebo

^a Fixed dose approximating 10 mg/kg (see section 4.2).

^b Concurrent DMARDs included one or more of the following: methotrexate, chloroquine/hydroxychloroquine, sulfasalazine, leflunomide, azathioprine, gold, and anakinra.

^c Health Assessment Questionnaire; 0 = best, 3 = worst; 20 questions; 8 categories: dressing and grooming, arising, eating, walking, hygiene, reach, grip, and activities.

^d Reduction in HAQ-DI of ≥ 0.3 units from baseline.

^e After 6 months, patients were given the opportunity to enter into an open-label study.

In study II, among patients with clinically meaningful improvement at month 12, 88% retained the response at month 18, and 85% retained the response at month 24. During the open-label periods of studies I, II, III, and VI the improvement in physical function has been maintained through 7 years, 5 years, 5 years, and 2 years, respectively.

In study SC-III, the proportion of subjects with a HAQ response as a measure of clinically meaningful improvement in physical function (reduction from baseline in HAQ-DI score of ≥ 0.3) was greater for the abatacept + MTX group vs. the MTX group at month 12 (65.5% vs 44.0%, respectively; treatment difference vs. MTX group of 21.6% [95% CI: 8.3, 34.9]).

Health-related outcomes and quality of life

Health-related quality of life was assessed by the SF-36 questionnaire at 6 months in studies I, II, and III and at 12 months in studies I and II. In these studies, clinically and statistically significant improvement was observed in the abatacept group as compared with the placebo group in all 8 domains of the SF-36 (4 physical domains: physical function, role physical, bodily pain, general health; and 4 mental domains: vitality, social function, role emotional, mental health), as well as the Physical Component Summary (PCS) and the Mental Component Summary (MCS). In study VI, improvement was observed at 12 months in abatacept plus methotrexate group as compared with the methotrexate plus placebo group in both PCS and MCS, and was maintained through 2 years.

Study VII: Safety of abatacept in patients with or without washout of previous TNF-inhibitor therapy

A study of open-label intravenous abatacept on a background of nonbiologic DMARDs was conducted in patients with active RA who had an inadequate response to previous (washout for at least 2 months; n = 449) or current (no washout period; n = 597) TNF-inhibitor therapy (study VII). The primary outcome, incidence of AEs, SAEs, and discontinuations due to AEs during 6 months of treatment, was similar between those who were previous and current TNF-inhibitor users at enrollment, as was the frequency of serious infections.

Study SC-I: Pre-filled pen sub-study

Patients in the sub-study (n = 117) of the open-label extension of study SC-I received 125 mg of subcutaneous abatacept administered weekly via the pre-filled syringe for at least 4 months, and were then switched to receive 125 mg SC abatacept administered weekly via the pre-filled pen for 12 weeks. The adjusted geometric mean of abatacept at steady state trough concentration (C_{min}) was 25.3 mcg/mL for the subcutaneous pre-filled pen and 27.8 mcg/mL for the subcutaneous pre-filled syringe with a ratio of 0.91 [90% CI: 0.83, 1.00]. During the 12-week pre-filled pen period of the sub-study, there were no deaths or related SAEs. Three patients had SAEs (postoperative wound infection, H1N1 influenza, and myocardial ischemia in 1 patient each) that were not considered related to the study drug. There were six overall discontinuations during this period, only one of which was due to an AE (the SAE of post-operative wound infection). Two patients (2/117, 1.7%) using the SC pre-filled pen experienced local injection site reactions.

Clinical efficacy and safety in adult psoriatic arthritis

The efficacy and safety of abatacept were assessed in two randomised, double-blind, placebo-controlled trials (studies PsA-I and PsA-II) in adult patients, age 18 years and older. Patients had active PsA (≥ 3 swollen joints and ≥ 3 tender joints) despite prior treatment with DMARD therapy and had one qualifying psoriatic skin lesion of at least 2 cm in diameter.

In study PsA-I, 170 patients received placebo or abatacept intravenously on Day 1, 15, 29, and then every 28 days thereafter in a double blind manner for 24 weeks, followed by open-label abatacept 10 mg/kg intravenous every 28 days. Patients were randomised to receive placebo or abatacept 3 mg/kg, 10 mg/kg, or two doses of 30 mg/kg followed by 10 mg/kg, without escape for 24 weeks, followed by open label abatacept 10 mg/kg monthly intravenous every month. Patients were allowed to receive stable doses of concomitant methotrexate, low dose corticosteroids (equivalent to ≤ 10 mg of prednisone) and/or NSAIDs during the trial.

In study PsA-II, 424 patients were randomised 1:1 to receive in a double-blind manner weekly doses of subcutaneous placebo or abatacept 125 mg without a loading dose for 24 weeks, followed by open-label abatacept 125 mg subcutaneous weekly. Patients were allowed to receive stable doses of concomitant methotrexate, sulfasalazine, leflunomide, hydroxychloroquine, low dose corticosteroids (equivalent to ≤ 10 mg of prednisone) and/or NSAIDs during the trial. Patients who had not achieved at least a 20% improvement from baseline in their swollen and tender joint counts by Week 16 escaped to open-label abatacept 125 mg subcutaneous weekly.

The primary endpoint for both PsA-I and PsA-II was the proportion of patients achieving ACR 20 response at Week 24 (day 169).

Clinical Response

Signs and symptoms

The percent of patients achieving ACR 20, 50, or 70 responses at the recommended abatacept dose in studies PsA-I (10 mg/kg intravenous) and PsA-II (125 mg subcutaneous) are presented in Table 7 below.

Table 7: Proportion of patients with ACR responses at week 24 in studies PsA-I and PsA-II

	PsA-I ^a			PsA-II ^{b,c}		
	Abatacept 10 mg/kg IV N = 40	Placebo N = 42	Estimate of difference (95% CI)	Abatacept 125 mg SC N = 213	Placebo N = 211	Estimate of difference (95% CI)
ACR 20	47.5%*	19.0%	28.7 (9.4, 48.0)	39.4%*	22.3%	17.2 (8.7, 25.6)
ACR 50	25.0%	2.4%	22.7 (8.6, 36.9)	19.2%	12.3%	6.9 (0.1, 13.7)
ACR 70	12.5%	0%	12.5 (2.3, 22.7)	10.3%	6.6%	3.7 (-1.5, 8.9)

* p < 0.05 vs placebo, p values not assessed for ACR 50 and ACR 70.

^a 37% of patients were previously treated with TNF inhibitor.

^b 61% of patients were previously treated with TNF inhibitor.

^c Patients who had less than 20% improvement in tender or swollen joint counts at Week 16 met escape criteria and were considered non-responders.

A significantly higher proportion of patients achieved an ACR 20 response after treatment with abatacept 10 mg/kg intravenous in PsA-I or 125 mg subcutaneous in PsA-II compared to placebo at Week 24 in the overall study populations. Higher ACR 20 responses were observed with abatacept vs placebo regardless of prior TNF-inhibitor treatment in both studies. In the smaller study PsA-I, the ACR 20 responses with abatacept 10 mg/kg intravenous vs placebo in patients who were TNF inhibitor-naïve were 55.6% vs 20.0%, respectively, and in patients who were TNF inhibitor-experienced were 30.8% vs 16.7%, respectively. In study PsA-II, the ACR 20 responses with abatacept 125 mg subcutaneous vs placebo in patients who were TNF inhibitor-naïve were 44.0% vs 22.2%, respectively (21.9 [8.3, 35.6], estimate of difference [95% CI]), and in patients who were TNF inhibitor-experienced were 36.4% vs 22.3%, respectively (14.0 [3.3, 24.8], estimate of difference [95% CI]).

Higher ACR 20 responses in study PsA-II were seen with abatacept 125 mg subcutaneous vs. placebo irrespective of concomitant non-biological DMARD treatment. The ACR 20 responses with abatacept 125 mg subcutaneous vs placebo in patients who did not use non-biological DMARDs were 27.3% vs 12.1%, respectively, (15.15 [1.83, 28.47] estimate of difference [95% CI]), and in patients who had used non-biological DMARDs were 44.9% vs 26.9%, respectively, (18.00 [7.20, 28.81], estimate of difference [95% CI]). Clinical responses were maintained or continued to improve up to one year in studies PsA-I and PsA-II.

Structural response

In study PsA-II, the proportion of radiographic non-progressors (≤ 0 change from baseline) in total PsA-modified SHS on x-rays at Week 24 was greater with abatacept 125 mg subcutaneous (42.7%) than placebo (32.7%) (10.0 [1.0, 19.1] estimate of difference [95% CI]).

Physical Function Response

In study PsA-I, the proportion of patients with ≥ 0.30 decrease from baseline in HAQ-DI score was 45.0% with intravenous abatacept vs 19.0% with placebo (26.1 [6.8, 45.5], estimate of difference [95% CI]) at Week 24. In study PsA-II, the proportion of patients with at least ≥ 0.35 decrease from baseline in HAQ-DI was 31.0% with abatacept vs. 23.7% with placebo (7.2 [-1.1, 15.6], estimate of difference [95% CI]). Improvement in HAQ-DI scores was maintained or improved for up to 1 year with continuing abatacept treatment in both PsA-I and PsA-II studies.

No significant changes in PASI scores with abatacept treatment were seen over the 24-week double-blind period. Patients entering the two PsA studies had mild to moderate psoriasis with median PASI scores of 8.6 in PsA-I and 4.5 in PsA-II. In study PsA-I, the proportions of patients achieving PASI 50 response was 28.6% with abatacept vs. 14.3% with placebo (14.3 [-15.3, 43.9], estimate of difference [95% CI]), and the proportion of patients who achieved PASI 75 response was 14.3% with abatacept vs. 4.8% with placebo (9.5 [-13.0, 32.0], estimate of difference [95% CI]). In study PsA-II, the proportion of patients who achieved PASI 50 response was 26.7% with abatacept vs. 19.6% with placebo (7.3 [-2.2, 16.7], estimate of difference [95% CI]), and the proportion of patients who achieved PASI 75 response was 16.4% with abatacept vs. 10.1% with placebo (6.4 [-1.3, 14.1], estimate of difference [95% CI]).

Paediatric population

ORENCIA powder for concentrate for solution for infusion and ORENCIA solution for injection in pre-filled syringe are approved in the paediatric patients with pJIA. Please refer to the ORENCIA powder for concentrate for solution for infusion 250 mg and ORENCIA solution for injection in pre-filled syringe 125 mg, 87.5 mg and 50 mg SmPCs.

5.2 Pharmacokinetic properties

Adult rheumatoid arthritis

The geometric mean estimate (90% confidence interval) for the bioavailability of abatacept following subcutaneous administration relative to intravenous administration is 78.6% (64.7%, 95.6%). The mean (range) for c_{\min} and c_{\max} at steady state observed after 85 days of treatment was 32.5 mcg/mL (6.6 to 113.8 mcg/mL) and 48.1 mcg/mL (9.8 to 132.4 mcg/mL), respectively. Mean estimates for systemic clearance (0.28 mL/h/kg), volume of distribution (0.11 L/kg), and terminal half-life (14.3 days) were comparable between subcutaneous and intravenous administration.

A single study was conducted to determine the effect of monotherapy use of abatacept on immunogenicity following subcutaneous administration without an intravenous load. When the intravenous loading dose was not administered, a mean trough concentration of 12.6 mcg/mL was achieved after 2 weeks of dosing. The efficacy response over time in this study appeared consistent with studies that included an intravenous loading dose, however, the effect of no intravenous load on the onset of efficacy has not been formally studied.

Consistent with the intravenous data, population pharmacokinetic analyses for subcutaneous abatacept in RA patients revealed that there was a trend toward higher clearance of abatacept with increasing body weight. Age and gender (when corrected for body weight) did not affect apparent clearance. Concomitant MTX, NSAIDs, corticosteroids, and TNF-inhibitors did not influence abatacept apparent clearance.

Adult psoriatic arthritis

In PsA-I, patients were randomised to receive intravenous placebo or abatacept 3 mg/kg (3/3 mg/kg), 10 mg/kg (10/10 mg/kg), or two doses of 30 mg/kg followed by 10 mg/kg (30/10 mg/kg), on day 1, 15, 29, and then every 28 days thereafter. In this study, the steady-state concentrations of abatacept were dose-related. The geometric mean (CV%) c_{\min} at day 169 were 7.8 mcg/mL (56.3%) for the

3/3 mg/kg, 24.3 mcg/mL (40.8%) for 10/10 mg/kg, and 26.6 mcg/mL (39.0%) for the 30/10 mg/kg regimens.

In study PsA-II following weekly subcutaneous administration of abatacept at 125 mg, steady-state of abatacept was reached at day 57 with the geometric mean (CV%) c_{\min} ranging from 22.3 (54.2%) to 25.6 (47.7%) mcg/mL on days 57 to 169, respectively.

Consistent with the results observed earlier in RA patients, population pharmacokinetic analyses for abatacept in PsA patients revealed that there was a trend toward higher clearance (L/h) of abatacept with increasing body weight.

5.3 Preclinical safety data

No mutagenicity or clastogenicity was observed with abatacept in a battery of *in vitro* studies. In a mouse carcinogenicity study, increases in the incidence of malignant lymphomas and mammary gland tumours (in females) occurred. The increased incidence of lymphomas and mammary tumours observed in mice treated with abatacept may have been associated with decreased control of murine leukaemia virus and mouse mammary tumour virus, respectively, in the presence of long-term immunomodulation. In a one-year toxicity study in cynomolgus monkeys, abatacept was not associated with any significant toxicity. Reversible pharmacological effects consisted of minimal transient decreases in serum IgG and minimal to severe lymphoid depletion of germinal centres in the spleen and/or lymph nodes. No evidence of lymphomas or preneoplastic morphological changes was observed, despite the presence of a virus, lymphocryptovirus, which is known to cause such lesions in immunosuppressed monkeys within the time frame of this study. The relevance of these findings to the clinical use of abatacept is unknown.

In rats, abatacept had no undesirable effects on male or female fertility. Embryo-foetal development studies were conducted with abatacept in mice, rats, and rabbits at doses up to 20 to 30 times a human 10 mg/kg dose and no undesirable effects were observed in the offspring. In rats and rabbits, abatacept exposure was up to 29-fold a human 10 mg/kg exposure based on AUC. Abatacept was shown to cross the placenta in rats and rabbits. In a pre- and postnatal development study with abatacept in rats, no undesirable effects were observed in pups of dams given abatacept at doses up to 45 mg/kg, representing 3-fold a human 10 mg/kg exposure based on AUC. At a dose of 200 mg/kg, representing 11-fold a human exposure at 10 mg/kg based on AUC, limited changes in immune function (a 9-fold increase in the mean T-cell-dependent antibody response in female pups and inflammation of the thyroid of 1 female pup out of 10 male and 10 female pups evaluated at this dose) were observed.

Non-clinical studies relevant for use in the paediatric population

Studies in rats exposed to abatacept have shown immune system abnormalities including a low incidence of infections leading to death (juvenile rats). In addition, inflammation of the thyroid and pancreas was frequently seen in both juvenile and adult rats exposed to abatacept. Juvenile rats seemed to be more sensitive to lymphocytic inflammation of thyroid. Studies in adult mice and monkeys have not demonstrated similar findings. It is likely that the increased susceptibility to opportunistic infections observed in juvenile rats is associated with the exposure to abatacept before development of memory responses. The relevance of these results to humans is unknown.

6. PHARMACEUTICAL PARTICULARS

6.1 List of excipients

Sucrose
Poloxamer 188
Sodium dihydrogen phosphate monohydrate
Disodium phosphate anhydrous
Water for injections

6.2 Incompatibilities

In the absence of compatibility studies, this medicinal product must not be mixed with other medicinal products.

6.3 Shelf life

2 years

6.4 Special precautions for storage

Store in a refrigerator (2°C - 8°C). Do not freeze.
Store in the original package in order to protect from light.

6.5 Nature and contents of container

One mL pre-filled syringe (Type 1 glass) in a pre-filled pen. The Type 1 glass syringe has a coated stopper and fixed stainless steel needle covered with a rigid needle shield.

Pack of 4 pre-filled pens and multipack containing 12 pre-filled pens (3 packs of 4).

Not all pack-sizes may be marketed.

6.6 Special precautions for disposal and other handling

The medicinal product is for single use only. After removing the pre-filled pen from the refrigerator the pre-filled pen should be allowed to reach room temperature by waiting 30 minutes, before injecting ORENCIA. The pen should not be shaken.

Any unused medicinal product or waste material should be disposed of in accordance with local requirements.

7. MARKETING AUTHORISATION HOLDER

Bristol-Myers Squibb Pharma EEIG
Plaza 254
Blanchardstown Corporate Park 2
Dublin 15, D15 T867
Ireland

8. MARKETING AUTHORISATION NUMBERS

EU/1/07/389/011-012

9. DATE OF FIRST AUTHORISATION/RENEWAL OF THE AUTHORISATION

Date of first authorisation: 21 May 2007

Date of latest renewal: 21 May 2012

10. DATE OF REVISION OF THE TEXT

Detailed information on this medicinal product is available on the website of the European Medicines Agency <http://www.ema.europa.eu>.

ANNEX II

- A. MANUFACTURER OF THE BIOLOGICAL ACTIVE SUBSTANCE AND MANUFACTURERS RESPONSIBLE FOR BATCH RELEASE**
- B. CONDITIONS OR RESTRICTIONS REGARDING SUPPLY AND USE**
- C. OTHER CONDITIONS AND REQUIREMENTS OF THE MARKETING AUTHORISATION**
- D. CONDITIONS OR RESTRICTIONS WITH REGARD TO THE SAFE AND EFFECTIVE USE OF THE MEDICINAL PRODUCT**

A. MANUFACTURER OF THE BIOLOGICAL ACTIVE SUBSTANCE AND MANUFACTURERS RESPONSIBLE FOR BATCH RELEASE

Name and address of the manufacturer of the biological active substance

Bristol-Myers Squibb Co.
38 Jackson Road
Devens, MA 01434
USA

Name and address of the manufacturers responsible for batch release

CATALENT ANAGNI S.R.L.
Loc. Fontana del Ceraso snc
Strada Provinciale 12 Casilina, 41
03012 Anagni (FR)
Italy

Swords Laboratories Unlimited Company t/a Bristol-Myers Squibb Cruiserath Biologics
Cruiserath Road, Mulhuddart
Dublin 15
Ireland

The printed package leaflet of the medicinal product must state the name and address of the manufacturer responsible for the release of the concerned batch.

B. CONDITIONS OR RESTRICTIONS REGARDING SUPPLY AND USE

Medicinal product subject to restricted medical prescription (see Annex I: Summary of Product Characteristics, section 4.2).

C. OTHER CONDITIONS AND REQUIREMENTS OF THE MARKETING AUTHORISATION

- **Periodic safety update reports (PSURs)**

The requirements for submission of PSURs for this medicinal product are set out in the list of Union reference dates (EURD list) provided for under Article 107c(7) of Directive 2001/83/EC and any subsequent updates published on the European medicines web-portal.

D. CONDITIONS OR RESTRICTIONS WITH REGARD TO THE SAFE AND EFFECTIVE USE OF THE MEDICINAL PRODUCT

- **Risk management plan (RMP)**

The marketing authorisation holder (MAH) shall perform the required pharmacovigilance activities and interventions detailed in the agreed RMP presented in Module 1.8.2 of the marketing authorisation and any agreed subsequent updates of the RMP.

An updated RMP should be submitted:

- At the request of the European Medicines Agency;
- Whenever the risk management system is modified, especially as the result of new information being received that may lead to a significant change to the benefit/risk profile or as the result of an important (pharmacovigilance or risk minimisation) milestone being reached.

- **Additional risk minimisation measures**

The Marketing Authorisation Holder (MAH) shall ensure that in each Member State where ORENCIA is marketed, all patients who are expected to use ORENCIA have access to the Patient Alert Card (provided within each medicine pack).

- **Patient alert card:**

- A warning message for healthcare professionals treating the patient at any time, including in conditions of emergency, that the patient is using ORENCIA
- That ORENCIA treatment may increase the risk of infections and allergic reactions.
- Signs or symptoms of the safety concern and when to seek attention from a healthcare professional
- Contact details of the ORENCIA prescriber
- A warning message for patients who have received ORENCIA while pregnant to inform healthcare personnel before any vaccination is given to the baby due to the potential risk of severe infection caused by immunisation with live vaccines

ANNEX III
LABELLING AND PACKAGE LEAFLET

A. LABELLING

PARTICULARS TO APPEAR ON THE OUTER PACKAGING

OUTER CARTON FOR PACK OF 1 VIAL

1. NAME OF THE MEDICINAL PRODUCT

ORENCIA 250 mg powder for concentrate for solution for infusion
abatacept

2. STATEMENT OF ACTIVE SUBSTANCE(S)

Each vial contains 250 mg abatacept.

3. LIST OF EXCIPIENTS

Excipients: maltose, sodium dihydrogen phosphate monohydrate and sodium chloride

4. PHARMACEUTICAL FORM AND CONTENTS

Powder for concentrate for solution for infusion

1 vial
1 silicone-free syringe

5. METHOD AND ROUTE(S) OF ADMINISTRATION

Read the package leaflet before use.
Intravenous use after reconstitution and dilution.

For single use only.
Use the silicone-free disposable syringe included in the package for reconstitution.

6. SPECIAL WARNING THAT THE MEDICINAL PRODUCT MUST BE STORED OUT OF THE SIGHT AND REACH OF CHILDREN

Keep out of the sight and reach of children.

7. OTHER SPECIAL WARNING(S), IF NECESSARY

8. EXPIRY DATE

EXP

Read the package leaflet for the shelf-life of the reconstituted product.

9. SPECIAL STORAGE CONDITIONS

Store in a refrigerator.
Store in the original package in order to protect from light.

10. SPECIAL PRECAUTIONS FOR DISPOSAL OF UNUSED MEDICINAL PRODUCTS OR WASTE MATERIALS DERIVED FROM SUCH MEDICINAL PRODUCTS, IF APPROPRIATE

Discard any unused solution.

11. NAME AND ADDRESS OF THE MARKETING AUTHORISATION HOLDER

Bristol-Myers Squibb Pharma EEIG
Plaza 254
Blanchardstown Corporate Park 2
Dublin 15, D15 T867
Ireland

12. MARKETING AUTHORISATION NUMBER(S)

EU/1/07/389/001 1 vial and 1 silicone-free syringe

13. BATCH NUMBER

Lot

14. GENERAL CLASSIFICATION FOR SUPPLY

15. INSTRUCTIONS ON USE

16. INFORMATION IN BRAILLE

Justification for not including Braille accepted.

17. UNIQUE IDENTIFIER – 2D BARCODE

2D barcode carrying the unique identifier included.

18. UNIQUE IDENTIFIER – HUMAN READABLE DATA

PC:
SN:
NN:

PARTICULARS TO APPEAR ON THE OUTER PACKAGING

OUTER CARTON FOR MULTIPACKS (INCLUDING BLUE BOX)

1. NAME OF THE MEDICINAL PRODUCT

ORENCIA 250 mg powder for concentrate for solution for infusion
abatacept

2. STATEMENT OF ACTIVE SUBSTANCE(S)

Each vial contains 250 mg abatacept.

3. LIST OF EXCIPIENTS

Excipients: maltose, sodium dihydrogen phosphate monohydrate and sodium chloride

4. PHARMACEUTICAL FORM AND CONTENTS

Powder for concentrate for solution for infusion

Multipack: 2 vials and 2 silicone-free syringes (2 packs of 1)

Multipack: 3 vials and 3 silicone-free syringes (3 packs of 1)

5. METHOD AND ROUTE(S) OF ADMINISTRATION

Read the package leaflet before use.
Intravenous use after reconstitution and dilution.

For single use only.
Use the silicone-free disposable syringe included in the package for reconstitution.

6. SPECIAL WARNING THAT THE MEDICINAL PRODUCT MUST BE STORED OUT OF THE SIGHT AND REACH OF CHILDREN

Keep out of the sight and reach of children.

7. OTHER SPECIAL WARNING(S), IF NECESSARY

8. EXPIRY DATE

EXP

Read the package leaflet for the shelf-life of the reconstituted product.

9. SPECIAL STORAGE CONDITIONS

Store in a refrigerator.
Store in the original package in order to protect from light.

10. SPECIAL PRECAUTIONS FOR DISPOSAL OF UNUSED MEDICINAL PRODUCTS OR WASTE MATERIALS DERIVED FROM SUCH MEDICINAL PRODUCTS, IF APPROPRIATE

Discard any unused solution.

11. NAME AND ADDRESS OF THE MARKETING AUTHORISATION HOLDER

Bristol-Myers Squibb Pharma EEIG
Plaza 254
Blanchardstown Corporate Park 2
Dublin 15, D15 T867
Ireland

12. MARKETING AUTHORISATION NUMBER(S)

EU/1/07/389/002 2 vials and 2 silicone-free syringes (2 packs of 1)
EU/1/07/389/003 3 vials and 3 silicone-free syringes (3 packs of 1)

13. BATCH NUMBER

Lot

14. GENERAL CLASSIFICATION FOR SUPPLY

15. INSTRUCTIONS ON USE

16. INFORMATION IN BRAILLE

Justification for not including Braille accepted.

17. UNIQUE IDENTIFIER – 2D BARCODE

2D barcode carrying the unique identifier included.

18. UNIQUE IDENTIFIER – HUMAN READABLE DATA

PC:
SN:
NN:

PARTICULARS TO APPEAR ON THE OUTER PACKAGING

CARTON AS INTERMEDIATE PACK (WITHOUT BLUE BOX)

1. NAME OF THE MEDICINAL PRODUCT

ORENCIA 250 mg powder for concentrate for solution for infusion
abatacept

2. STATEMENT OF ACTIVE SUBSTANCE(S)

Each vial contains 250 mg abatacept.

3. LIST OF EXCIPIENTS

Excipients: maltose, sodium dihydrogen phosphate monohydrate and sodium chloride

4. PHARMACEUTICAL FORM AND CONTENTS

Powder for concentrate for solution for infusion

1 vial
1 silicone-free syringe

Component of a multipack, can't be sold separately.

5. METHOD AND ROUTE(S) OF ADMINISTRATION

Read the package leaflet before use.
Intravenous use after reconstitution and dilution.

For single use only.
Use the silicone-free disposable syringe included in the package for reconstitution.

6. SPECIAL WARNING THAT THE MEDICINAL PRODUCT MUST BE STORED OUT OF THE SIGHT AND REACH OF CHILDREN

Keep out of the sight and reach of children.

7. OTHER SPECIAL WARNING(S), IF NECESSARY

8. EXPIRY DATE

EXP

Read the package leaflet for the shelf-life of the reconstituted product.

9. SPECIAL STORAGE CONDITIONS

Store in a refrigerator.

Store in the original package in order to protect from light.

10. SPECIAL PRECAUTIONS FOR DISPOSAL OF UNUSED MEDICINAL PRODUCTS OR WASTE MATERIALS DERIVED FROM SUCH MEDICINAL PRODUCTS, IF APPROPRIATE

Discard any unused solution.

11. NAME AND ADDRESS OF THE MARKETING AUTHORISATION HOLDER

Bristol-Myers Squibb Pharma EEIG
Plaza 254
Blanchardstown Corporate Park 2
Dublin 15, D15 T867
Ireland

12. MARKETING AUTHORISATION NUMBER(S)

EU/1/07/389/002 2 vials and 2 silicone-free syringes (2 packs of 1)

EU/1/07/389/003 3 vials and 3 silicone-free syringes (3 packs of 1)

13. BATCH NUMBER

Lot

14. GENERAL CLASSIFICATION FOR SUPPLY

15. INSTRUCTIONS ON USE

16. INFORMATION IN BRAILLE

Justification for not including Braille accepted.

17. UNIQUE IDENTIFIER – 2D BARCODE

18. UNIQUE IDENTIFIER – HUMAN READABLE DATA

MINIMUM PARTICULARS TO APPEAR ON SMALL IMMEDIATE PACKAGING UNITS

VIAL LABEL

1. NAME OF THE MEDICINAL PRODUCT AND ROUTE OF ADMINISTRATION

ORENCIA 250 mg powder for concentrate for solution for infusion
abatacept
Intravenous use

2. METHOD OF ADMINISTRATION

3. EXPIRY DATE

EXP

4. BATCH NUMBER

Lot

5. CONTENTS BY WEIGHT, BY VOLUME OR BY UNIT

6. OTHER

Use the silicone-free disposable syringe included in the package for reconstitution.

PARTICULARS TO APPEAR ON THE OUTER PACKAGING

OUTER CARTON FOR PACKS OF 4 PRE-FILLED SYRINGES WITH NEEDLE GUARD

1. NAME OF THE MEDICINAL PRODUCT

ORENCIA 50 mg solution for injection in pre-filled syringe
abatacept

2. STATEMENT OF ACTIVE SUBSTANCE(S)

One pre-filled syringe contains 50 mg abatacept in 0.4 mL.

3. LIST OF EXCIPIENTS

Excipients: sucrose, poloxamer 188, sodium dihydrogen phosphate monohydrate, disodium phosphate anhydrous, water for injections.

4. PHARMACEUTICAL FORM AND CONTENTS

Solution for injection in pre-filled syringe

4 pre-filled syringes with needle guard

5. METHOD AND ROUTE(S) OF ADMINISTRATION

Read the package leaflet before use.
Subcutaneous use.

6. SPECIAL WARNING THAT THE MEDICINAL PRODUCT MUST BE STORED OUT OF THE SIGHT AND REACH OF CHILDREN

Keep out of the sight and reach of children.

7. OTHER SPECIAL WARNING(S), IF NECESSARY

8. EXPIRY DATE

EXP

9. SPECIAL STORAGE CONDITIONS

Store in a refrigerator.
Do not freeze.
Store in the original package in order to protect from light.

10. SPECIAL PRECAUTIONS FOR DISPOSAL OF UNUSED MEDICINAL PRODUCTS OR WASTE MATERIALS DERIVED FROM SUCH MEDICINAL PRODUCTS, IF APPROPRIATE

11. NAME AND ADDRESS OF THE MARKETING AUTHORISATION HOLDER

Bristol-Myers Squibb Pharma EEIG
Plaza 254
Blanchardstown Corporate Park 2
Dublin 15, D15 T867
Ireland

12. MARKETING AUTHORISATION NUMBER(S)

EU/1/07/389/013 4 pre-filled syringes with needle guard

13. BATCH NUMBER

Lot

14. GENERAL CLASSIFICATION FOR SUPPLY

15. INSTRUCTIONS ON USE

16. INFORMATION IN BRAILLE

ORENCIA 50 mg

17. UNIQUE IDENTIFIER – 2D BARCODE

2D barcode carrying the unique identifier included.

18. UNIQUE IDENTIFIER – HUMAN READABLE DATA

PC:
SN:
NN:

MINIMUM PARTICULARS TO APPEAR ON SMALL IMMEDIATE PACKAGING UNITS

LABEL FOR SYRINGE

1. NAME OF THE MEDICINAL PRODUCT AND ROUTE(S) OF ADMINISTRATION

ORENCIA 50 mg injection
abatacept
SC

2. METHOD OF ADMINISTRATION

3. EXPIRY DATE

EXP

4. BATCH NUMBER

Lot

5. CONTENTS BY WEIGHT, BY VOLUME OR BY UNIT

6. OTHER

PARTICULARS TO APPEAR ON THE OUTER PACKAGING

OUTER CARTON FOR PACKS OF 4 PRE-FILLED SYRINGES WITH NEEDLE GUARD

1. NAME OF THE MEDICINAL PRODUCT

ORENCIA 87.5 mg solution for injection in pre-filled syringe
abatacept

2. STATEMENT OF ACTIVE SUBSTANCE(S)

One pre-filled syringe contains 87.5 mg abatacept in 0.7 mL.

3. LIST OF EXCIPIENTS

Excipients: sucrose, poloxamer 188, sodium dihydrogen phosphate monohydrate, disodium phosphate anhydrous, water for injections.

4. PHARMACEUTICAL FORM AND CONTENTS

Solution for injection in pre-filled syringe

4 pre-filled syringes with needle guard

5. METHOD AND ROUTE(S) OF ADMINISTRATION

Read the package leaflet before use.
Subcutaneous use.

6. SPECIAL WARNING THAT THE MEDICINAL PRODUCT MUST BE STORED OUT OF THE SIGHT AND REACH OF CHILDREN

Keep out of the sight and reach of children.

7. OTHER SPECIAL WARNING(S), IF NECESSARY

8. EXPIRY DATE

EXP

9. SPECIAL STORAGE CONDITIONS

Store in a refrigerator.
Do not freeze.
Store in the original package in order to protect from light.

10. SPECIAL PRECAUTIONS FOR DISPOSAL OF UNUSED MEDICINAL PRODUCTS OR WASTE MATERIALS DERIVED FROM SUCH MEDICINAL PRODUCTS, IF APPROPRIATE

11. NAME AND ADDRESS OF THE MARKETING AUTHORISATION HOLDER

Bristol-Myers Squibb Pharma EEIG
Plaza 254
Blanchardstown Corporate Park 2
Dublin 15, D15 T867
Ireland

12. MARKETING AUTHORISATION NUMBER(S)

EU/1/07/389/014 4 pre-filled syringes with needle guard

13. BATCH NUMBER

Lot

14. GENERAL CLASSIFICATION FOR SUPPLY

15. INSTRUCTIONS ON USE

16. INFORMATION IN BRAILLE

ORENCIA 87.5 mg

17. UNIQUE IDENTIFIER – 2D BARCODE

2D barcode carrying the unique identifier included.

18. UNIQUE IDENTIFIER – HUMAN READABLE DATA

PC:
SN:
NN:

MINIMUM PARTICULARS TO APPEAR ON SMALL IMMEDIATE PACKAGING UNITS

LABEL FOR SYRINGE

1. NAME OF THE MEDICINAL PRODUCT AND ROUTE(S) OF ADMINISTRATION

ORENCIA 87.5 mg injection
abatacept
SC

2. METHOD OF ADMINISTRATION

3. EXPIRY DATE

EXP

4. BATCH NUMBER

Lot

5. CONTENTS BY WEIGHT, BY VOLUME OR BY UNIT

6. OTHER

PARTICULARS TO APPEAR ON THE OUTER PACKAGING

OUTER CARTON FOR PACKS OF 1, 3 AND 4 PRE-FILLED SYRINGES WITH NEEDLE GUARD

1. NAME OF THE MEDICINAL PRODUCT

ORENCIA 125 mg solution for injection in pre-filled syringe
abatacept

2. STATEMENT OF ACTIVE SUBSTANCE(S)

One pre-filled syringe contains 125 mg abatacept in one mL.

3. LIST OF EXCIPIENTS

Excipients: sucrose, poloxamer 188, sodium dihydrogen phosphate monohydrate, disodium phosphate anhydrous, water for injections.

4. PHARMACEUTICAL FORM AND CONTENTS

Solution for injection in pre-filled syringe

1 pre-filled syringe with needle guard

3 pre-filled syringes with needle guard

4 pre-filled syringes with needle guard

5. METHOD AND ROUTE(S) OF ADMINISTRATION

Read the package leaflet before use.
Subcutaneous use.

6. SPECIAL WARNING THAT THE MEDICINAL PRODUCT MUST BE STORED OUT OF THE SIGHT AND REACH OF CHILDREN

Keep out of the sight and reach of children.

7. OTHER SPECIAL WARNING(S), IF NECESSARY

8. EXPIRY DATE

EXP

9. SPECIAL STORAGE CONDITIONS

Store in a refrigerator.
Do not freeze.
Store in the original package in order to protect from light.

10. SPECIAL PRECAUTIONS FOR DISPOSAL OF UNUSED MEDICINAL PRODUCTS OR WASTE MATERIALS DERIVED FROM SUCH MEDICINAL PRODUCTS, IF APPROPRIATE**11. NAME AND ADDRESS OF THE MARKETING AUTHORISATION HOLDER**

Bristol-Myers Squibb Pharma EEIG
Plaza 254
Blanchardstown Corporate Park 2
Dublin 15, D15 T867
Ireland

12. MARKETING AUTHORISATION NUMBER(S)

EU/1/07/389/007 1 pre-filled syringe with needle guard
EU/1/07/389/008 4 pre-filled syringes with needle guard
EU/1/07/389/010 3 pre-filled syringes with needle guard

13. BATCH NUMBER

Lot

14. GENERAL CLASSIFICATION FOR SUPPLY**15. INSTRUCTIONS ON USE****16. INFORMATION IN BRAILLE**

ORENCIA 125 mg

17. UNIQUE IDENTIFIER – 2D BARCODE

2D barcode carrying the unique identifier included.

18. UNIQUE IDENTIFIER – HUMAN READABLE DATA

PC:
SN:
NN:

PARTICULARS TO APPEAR ON THE OUTER PACKAGING

OUTER CARTON FOR MULTIPACK (INCLUDING BLUE BOX)

1. NAME OF THE MEDICINAL PRODUCT

ORENCIA 125 mg solution for injection in pre-filled syringe
abatacept

2. STATEMENT OF ACTIVE SUBSTANCE(S)

One pre-filled syringe contains 125 mg abatacept in one mL.

3. LIST OF EXCIPIENTS

Excipients: sucrose, poloxamer 188, sodium dihydrogen phosphate monohydrate, disodium phosphate anhydrous, water for injections.

4. PHARMACEUTICAL FORM AND CONTENTS

Solution for injection in pre-filled syringe

Multipack: 12 pre-filled syringes with needle guard (3 packs of 4)

5. METHOD AND ROUTE(S) OF ADMINISTRATION

Read the package leaflet before use.
Subcutaneous use.

6. SPECIAL WARNING THAT THE MEDICINAL PRODUCT MUST BE STORED OUT OF THE SIGHT AND REACH OF CHILDREN

Keep out of the sight and reach of children.

7. OTHER SPECIAL WARNING(S), IF NECESSARY

8. EXPIRY DATE

EXP

9. SPECIAL STORAGE CONDITIONS

Store in a refrigerator.
Do not freeze.
Store in the original package in order to protect from light.

10. SPECIAL PRECAUTIONS FOR DISPOSAL OF UNUSED MEDICINAL PRODUCTS OR WASTE MATERIALS DERIVED FROM SUCH MEDICINAL PRODUCTS, IF APPROPRIATE

11. NAME AND ADDRESS OF THE MARKETING AUTHORISATION HOLDER

Bristol-Myers Squibb Pharma EEIG
Plaza 254
Blanchardstown Corporate Park 2
Dublin 15, D15 T867
Ireland

12. MARKETING AUTHORISATION NUMBER(S)

EU/1/07/389/009 12 pre-filled syringes with needle guard (3 packs of 4)

13. BATCH NUMBER

Lot

14. GENERAL CLASSIFICATION FOR SUPPLY

15. INSTRUCTIONS ON USE

16. INFORMATION IN BRAILLE

ORENCIA 125 mg

17. UNIQUE IDENTIFIER – 2D BARCODE

2D barcode carrying the unique identifier included.

18. UNIQUE IDENTIFIER – HUMAN READABLE DATA

PC:
SN:
NN:

PARTICULARS TO APPEAR ON THE OUTER PACKAGING

CARTON AS INTERMEDIATE PACK (WITHOUT BLUE BOX)

1. NAME OF THE MEDICINAL PRODUCT

ORENCIA 125 mg solution for injection in pre-filled syringe
abatacept

2. STATEMENT OF ACTIVE SUBSTANCE(S)

One pre-filled syringe contains 125 mg abatacept in one mL.

3. LIST OF EXCIPIENTS

Excipients: sucrose, poloxamer 188, sodium dihydrogen phosphate monohydrate, disodium phosphate anhydrous, water for injections.

4. PHARMACEUTICAL FORM AND CONTENTS

Solution for injection in pre-filled syringe

4 pre-filled syringes with needle guard

Component of a multipack, can't be sold separately.

5. METHOD AND ROUTE(S) OF ADMINISTRATION

Subcutaneous use.
Read the package leaflet before use.

6. SPECIAL WARNING THAT THE MEDICINAL PRODUCT MUST BE STORED OUT OF THE SIGHT AND REACH OF CHILDREN

Keep out of the sight and reach of children.

7. OTHER SPECIAL WARNING(S), IF NECESSARY

8. EXPIRY DATE

EXP

9. SPECIAL STORAGE CONDITIONS

Store in a refrigerator.
Do not freeze.
Store in the original package in order to protect from light.

10. SPECIAL PRECAUTIONS FOR DISPOSAL OF UNUSED MEDICINAL PRODUCTS OR WASTE MATERIALS DERIVED FROM SUCH MEDICINAL PRODUCTS, IF APPROPRIATE

11. NAME AND ADDRESS OF THE MARKETING AUTHORISATION HOLDER

Bristol-Myers Squibb Pharma EEIG
Plaza 254
Blanchardstown Corporate Park 2
Dublin 15, D15 T867
Ireland

12. MARKETING AUTHORISATION NUMBER(S)

EU/1/07/389/009 12 pre-filled syringes with needle guard (3 packs of 4)

13. BATCH NUMBER

Lot

14. GENERAL CLASSIFICATION FOR SUPPLY

15. INSTRUCTIONS ON USE

16. INFORMATION IN BRAILLE

ORENCIA 125 mg

17. UNIQUE IDENTIFIER – 2D BARCODE

18. UNIQUE IDENTIFIER – HUMAN READABLE DATA

MINIMUM PARTICULARS TO APPEAR ON SMALL IMMEDIATE PACKAGING UNITS

LABEL FOR SYRINGE

1. NAME OF THE MEDICINAL PRODUCT AND ROUTE(S) OF ADMINISTRATION

ORENCIA 125 mg injection
abatacept
SC

2. METHOD OF ADMINISTRATION

3. EXPIRY DATE

EXP

4. BATCH NUMBER

Lot

5. CONTENTS BY WEIGHT, BY VOLUME OR BY UNIT

6. OTHER

PARTICULARS TO APPEAR ON THE OUTER PACKAGING

OUTER CARTON FOR PACKS OF 1 AND 4 PRE-FILLED SYRINGES

1. NAME OF THE MEDICINAL PRODUCT

ORENCIA 125 mg solution for injection in pre-filled syringe
abatacept

2. STATEMENT OF ACTIVE SUBSTANCE(S)

One pre-filled syringe contains 125 mg abatacept in one mL.

3. LIST OF EXCIPIENTS

Excipients: sucrose, poloxamer 188, sodium dihydrogen phosphate monohydrate, disodium phosphate anhydrous, water for injections.

4. PHARMACEUTICAL FORM AND CONTENTS

Solution for injection in pre-filled syringe

1 pre-filled syringe

4 pre-filled syringes

5. METHOD AND ROUTE(S) OF ADMINISTRATION

Read the package leaflet before use.
Subcutaneous use.

6. SPECIAL WARNING THAT THE MEDICINAL PRODUCT MUST BE STORED OUT OF THE SIGHT AND REACH OF CHILDREN

Keep out of the sight and reach of children.

7. OTHER SPECIAL WARNING(S), IF NECESSARY

8. EXPIRY DATE

EXP

9. SPECIAL STORAGE CONDITIONS

Store in a refrigerator.
Do not freeze.
Store in the original package in order to protect from light.

10. SPECIAL PRECAUTIONS FOR DISPOSAL OF UNUSED MEDICINAL PRODUCTS OR WASTE MATERIALS DERIVED FROM SUCH MEDICINAL PRODUCTS, IF APPROPRIATE**11. NAME AND ADDRESS OF THE MARKETING AUTHORISATION HOLDER**

Bristol-Myers Squibb Pharma EEIG
Plaza 254
Blanchardstown Corporate Park 2
Dublin 15, D15 T867
Ireland

12. MARKETING AUTHORISATION NUMBER(S)

EU/1/07/389/004 1 pre-filled syringe
EU/1/07/389/005 4 pre-filled syringes

13. BATCH NUMBER

Lot

14. GENERAL CLASSIFICATION FOR SUPPLY**15. INSTRUCTIONS ON USE****16. INFORMATION IN BRAILLE**

ORENCIA 125 mg

17. UNIQUE IDENTIFIER – 2D BARCODE

2D barcode carrying the unique identifier included.

18. UNIQUE IDENTIFIER – HUMAN READABLE DATA

PC:
SN:
NN:

PARTICULARS TO APPEAR ON THE OUTER PACKAGING

OUTER CARTON FOR MULTIPACK (INCLUDING BLUE BOX)

1. NAME OF THE MEDICINAL PRODUCT

ORENCIA 125 mg solution for injection in pre-filled syringe
abatacept

2. STATEMENT OF ACTIVE SUBSTANCE(S)

One pre-filled syringe contains 125 mg abatacept in one mL.

3. LIST OF EXCIPIENTS

Excipients: sucrose, poloxamer 188, sodium dihydrogen phosphate monohydrate, disodium phosphate anhydrous, and water for injections.

4. PHARMACEUTICAL FORM AND CONTENTS

Solution for injection in pre-filled syringe

Multipack: 12 pre-filled syringes (3 packs of 4)

5. METHOD AND ROUTE(S) OF ADMINISTRATION

Read the package leaflet before use.
Subcutaneous use.

6. SPECIAL WARNING THAT THE MEDICINAL PRODUCT MUST BE STORED OUT OF THE SIGHT AND REACH OF CHILDREN

Keep out of the sight and reach of children.

7. OTHER SPECIAL WARNING(S), IF NECESSARY

8. EXPIRY DATE

EXP

9. SPECIAL STORAGE CONDITIONS

Store in a refrigerator.
Do not freeze.
Store in the original package in order to protect from light.

10. SPECIAL PRECAUTIONS FOR DISPOSAL OF UNUSED MEDICINAL PRODUCTS OR WASTE MATERIALS DERIVED FROM SUCH MEDICINAL PRODUCTS, IF APPROPRIATE**11. NAME AND ADDRESS OF THE MARKETING AUTHORISATION HOLDER**

Bristol-Myers Squibb Pharma EEIG
Plaza 254
Blanchardstown Corporate Park 2
Dublin 15, D15 T867
Ireland

12. MARKETING AUTHORISATION NUMBER(S)

EU/1/07/389/006 12 pre-filled syringes (3 packs of 4)

13. BATCH NUMBER

Lot

14. GENERAL CLASSIFICATION FOR SUPPLY**15. INSTRUCTIONS ON USE****16. INFORMATION IN BRAILLE**

ORENCIA 125 mg

17. UNIQUE IDENTIFIER – 2D BARCODE

2D barcode carrying the unique identifier included.

18. UNIQUE IDENTIFIER – HUMAN READABLE DATA

PC:
SN:
NN:

PARTICULARS TO APPEAR ON THE OUTER PACKAGING

CARTON AS INTERMEDIATE PACK (WITHOUT BLUE BOX)

1. NAME OF THE MEDICINAL PRODUCT

ORENCIA 125 mg solution for injection in pre-filled syringe
abatacept

2. STATEMENT OF ACTIVE SUBSTANCE(S)

One pre-filled syringe contains 125 mg abatacept in one mL.

3. LIST OF EXCIPIENTS

Excipients: sucrose, poloxamer 188, sodium dihydrogen phosphate monohydrate, disodium phosphate anhydrous, and water for injections.

4. PHARMACEUTICAL FORM AND CONTENTS

Solution for injection in pre-filled syringe

4 pre-filled syringes

Component of a multipack, can't be sold separately.

5. METHOD AND ROUTE(S) OF ADMINISTRATION

Read the package leaflet before use.
Subcutaneous use.

6. SPECIAL WARNING THAT THE MEDICINAL PRODUCT MUST BE STORED OUT OF THE SIGHT AND REACH OF CHILDREN

Keep out of the sight and reach of children.

7. OTHER SPECIAL WARNING(S), IF NECESSARY

8. EXPIRY DATE

EXP

9. SPECIAL STORAGE CONDITIONS

Store in a refrigerator.
Do not freeze.
Store in the original package in order to protect from light.

10. SPECIAL PRECAUTIONS FOR DISPOSAL OF UNUSED MEDICINAL PRODUCTS OR WASTE MATERIALS DERIVED FROM SUCH MEDICINAL PRODUCTS, IF APPROPRIATE

11. NAME AND ADDRESS OF THE MARKETING AUTHORISATION HOLDER

Bristol-Myers Squibb Pharma EEIG
Plaza 254
Blanchardstown Corporate Park 2
Dublin 15, D15 T867
Ireland

12. MARKETING AUTHORISATION NUMBER(S)

EU/1/07/389/006 12 pre-filled syringes (3 packs of 4)

13. BATCH NUMBER

Lot

14. GENERAL CLASSIFICATION FOR SUPPLY

15. INSTRUCTIONS ON USE

16. INFORMATION IN BRAILLE

ORENCIA 125 mg

17. UNIQUE IDENTIFIER – 2D BARCODE

18. UNIQUE IDENTIFIER – HUMAN READABLE DATA

PARTICULARS TO APPEAR ON THE OUTER PACKAGING

OUTER CARTON FOR PACK OF 4 PRE-FILLED PENS

1. NAME OF THE MEDICINAL PRODUCT

ORENCIA 125 mg solution for injection in pre-filled pen
abatacept

2. STATEMENT OF ACTIVE SUBSTANCE(S)

One pre-filled pen contains 125 mg abatacept in one mL.

3. LIST OF EXCIPIENTS

Excipients: sucrose, poloxamer 188, sodium dihydrogen phosphate monohydrate, disodium phosphate anhydrous, water for injections.

4. PHARMACEUTICAL FORM AND CONTENTS

Solution for injection in pre-filled pen (ClickJect)

4 ClickJect pre-filled pens

5. METHOD AND ROUTE(S) OF ADMINISTRATION

Read the package leaflet before use.
Subcutaneous use.

6. SPECIAL WARNING THAT THE MEDICINAL PRODUCT MUST BE STORED OUT OF THE SIGHT AND REACH OF CHILDREN

Keep out of the sight and reach of children.

7. OTHER SPECIAL WARNING(S), IF NECESSARY

8. EXPIRY DATE

EXP

9. SPECIAL STORAGE CONDITIONS

Store in a refrigerator.
Do not freeze.
Store in the original package in order to protect from light.

10. SPECIAL PRECAUTIONS FOR DISPOSAL OF UNUSED MEDICINAL PRODUCTS OR WASTE MATERIALS DERIVED FROM SUCH MEDICINAL PRODUCTS, IF APPROPRIATE

11. NAME AND ADDRESS OF THE MARKETING AUTHORISATION HOLDER

Bristol-Myers Squibb Pharma EEIG
Plaza 254
Blanchardstown Corporate Park 2
Dublin 15, D15 T867
Ireland

12. MARKETING AUTHORISATION NUMBER(S)

EU/1/07/389/011 4 pre-filled pens

13. BATCH NUMBER

Lot

14. GENERAL CLASSIFICATION FOR SUPPLY

15. INSTRUCTIONS ON USE

16. INFORMATION IN BRAILLE

ORENCIA 125 mg

17. UNIQUE IDENTIFIER – 2D BARCODE

2D barcode carrying the unique identifier included.

18. UNIQUE IDENTIFIER – HUMAN READABLE DATA

PC:
SN:
NN:

PARTICULARS TO APPEAR ON THE OUTER PACKAGING

OUTER CARTON FOR MULTIPACK (INCLUDING BLUE BOX)

1. NAME OF THE MEDICINAL PRODUCT

ORENCIA 125 mg solution for injection in pre-filled pen
abatacept

2. STATEMENT OF ACTIVE SUBSTANCE(S)

One pre-filled pen contains 125 mg abatacept in one mL.

3. LIST OF EXCIPIENTS

Excipients: sucrose, poloxamer 188, sodium dihydrogen phosphate monohydrate, disodium phosphate anhydrous, water for injections.

4. PHARMACEUTICAL FORM AND CONTENTS

Solution for injection in pre-filled pen (ClickJect)

Multipack: 12 ClickJect pre-filled pens (3 packs of 4)

5. METHOD AND ROUTE(S) OF ADMINISTRATION

Read the package leaflet before use.
Subcutaneous use.

6. SPECIAL WARNING THAT THE MEDICINAL PRODUCT MUST BE STORED OUT OF THE SIGHT AND REACH OF CHILDREN

Keep out of the sight and reach of children.

7. OTHER SPECIAL WARNING(S), IF NECESSARY

8. EXPIRY DATE

EXP

9. SPECIAL STORAGE CONDITIONS

Store in a refrigerator.
Do not freeze.
Store in the original package in order to protect from light.

10. SPECIAL PRECAUTIONS FOR DISPOSAL OF UNUSED MEDICINAL PRODUCTS OR WASTE MATERIALS DERIVED FROM SUCH MEDICINAL PRODUCTS, IF APPROPRIATE

11. NAME AND ADDRESS OF THE MARKETING AUTHORISATION HOLDER

Bristol-Myers Squibb Pharma EEIG
Plaza 254
Blanchardstown Corporate Park 2
Dublin 15, D15 T867
Ireland

12. MARKETING AUTHORISATION NUMBER(S)

EU/1/07/389/012 12 pre-filled pens (3 packs of 4)

13. BATCH NUMBER

Lot

14. GENERAL CLASSIFICATION FOR SUPPLY

15. INSTRUCTIONS ON USE

16. INFORMATION IN BRAILLE

ORENCIA 125 mg

17. UNIQUE IDENTIFIER – 2D BARCODE

2D barcode carrying the unique identifier included.

18. UNIQUE IDENTIFIER – HUMAN READABLE DATA

PC:
SN:
NN:

PARTICULARS TO APPEAR ON THE OUTER PACKAGING

CARTON AS INTERMEDIATE PACK (WITHOUT BLUE BOX)

1. NAME OF THE MEDICINAL PRODUCT

ORENCIA 125 mg solution for injection in pre-filled pen
abatacept

2. STATEMENT OF ACTIVE SUBSTANCE(S)

One pre-filled pen contains 125 mg abatacept in one mL.

3. LIST OF EXCIPIENTS

Excipients: sucrose, poloxamer 188, sodium dihydrogen phosphate monohydrate, disodium phosphate anhydrous, water for injections.

4. PHARMACEUTICAL FORM AND CONTENTS

Solution for injection in pre-filled pen (ClickJect)

4 ClickJect pre-filled pens

Component of a multipack, can't be sold separately.

5. METHOD AND ROUTE(S) OF ADMINISTRATION

Read the package leaflet before use.
Subcutaneous use.

6. SPECIAL WARNING THAT THE MEDICINAL PRODUCT MUST BE STORED OUT OF THE SIGHT AND REACH OF CHILDREN

Keep out of the sight and reach of children.

7. OTHER SPECIAL WARNING(S), IF NECESSARY

8. EXPIRY DATE

EXP

9. SPECIAL STORAGE CONDITIONS

Store in a refrigerator.
Do not freeze.
Store in the original package in order to protect from light.

10. SPECIAL PRECAUTIONS FOR DISPOSAL OF UNUSED MEDICINAL PRODUCTS OR WASTE MATERIALS DERIVED FROM SUCH MEDICINAL PRODUCTS, IF APPROPRIATE**11. NAME AND ADDRESS OF THE MARKETING AUTHORISATION HOLDER**

Bristol-Myers Squibb Pharma EEIG
Plaza 254
Blanchardstown Corporate Park 2
Dublin 15, D15 T867
Ireland

12. MARKETING AUTHORISATION NUMBER(S)

EU/1/07/389/012 12 pre-filled pens (3 packs of 4)

13. BATCH NUMBER

Lot

14. GENERAL CLASSIFICATION FOR SUPPLY**15. INSTRUCTIONS ON USE****16. INFORMATION IN BRAILLE**

ORENCIA 125 mg

17. UNIQUE IDENTIFIER – 2D BARCODE**18. UNIQUE IDENTIFIER – HUMAN READABLE DATA**

**MINIMUM PARTICULARS TO APPEAR ON SMALL IMMEDIATE PACKAGING UNITS
LABEL FOR PRE-FILLED PEN**

1. NAME OF THE MEDICINAL PRODUCT AND ROUTE(S) OF ADMINISTRATION

ORENCIA 125 mg injection
abatacept
Subcutaneous use

2. METHOD OF ADMINISTRATION

3. EXPIRY DATE

EXP

4. BATCH NUMBER

Lot

5. CONTENTS BY WEIGHT, BY VOLUME OR BY UNIT

6. OTHER

ORENCIA IV PATIENT ALERT CARD TEXT

<p style="text-align: center;">ORENCIA Patient Alert Card</p> <p>This alert card contains important safety information that you need to be aware of before you are given ORENCIA and during treatment with ORENCIA.</p> <ul style="list-style-type: none">• Show this card to any doctor involved in your treatment. <p>Infections</p> <p>ORENCIA increases the risk of getting infections.</p> <ul style="list-style-type: none">- You must not be treated with ORENCIA if you have severe infection.- You should be screened for certain infections prior to treatment with ORENCIA. <p>Tuberculosis (TB): You should be screened for TB prior to ORENCIA treatment. It is very important that you tell your doctor if you have ever had TB, or if you have been in close contact with someone who has had TB.</p> <p>Hepatitis: Anti-rheumatic therapies have been associated with hepatitis B reactivation. You should be screened for viral hepatitis in accordance with published guidelines.</p>	<p>Infections</p> <ul style="list-style-type: none">- If you develop symptoms suggestive of infections, such as fever, persistent cough, weight loss, or listlessness, seek medical attention immediately. <p>Allergic Reactions</p> <p>Allergic reactions may occur after the use of ORENCIA. If you experience symptoms such as chest tightness, wheezing, severe dizziness, or lightheadedness, seek medical attention immediately.</p> <p>Dates of ORENCIA Treatment:</p> <p>Start: _____</p> <p>Most recent: _____</p> <ul style="list-style-type: none">• See the ORENCIA package leaflet for more information.• Please make sure you also have a list of all your other medicines with you at any visit to a health care professional. <p>Patient's Name: _____</p> <p>Doctor's Name: _____</p> <p>Doctor's Phone: _____</p> <p>Keep this card with you for 3 months after the last ORENCIA dose, since side effects may occur a long time after your last dose of ORENCIA.</p> <p>ORENCIA should not be used in pregnant women unless clearly necessary. If you have received ORENCIA while you were pregnant, it is important that you inform the baby's health care personnel before any vaccinations are given to your baby. Your baby may be at risk of severe infection caused by "live vaccines" for 14 weeks since your last ORENCIA administration.</p> <p style="text-align: right;">[Mmm YYYY]</p>
--	--

ORENCIA SC PATIENT ALERT CARD TEXT

<p style="text-align: center;">ORENCIA Patient Alert Card</p> <p>This alert card contains important safety information that you need to be aware of before you are given ORENCIA and during treatment with ORENCIA.</p> <ul style="list-style-type: none">• Show this card to any doctor involved in your treatment. <p>Infections</p> <p>ORENCIA increases the risk of getting infections.</p> <ul style="list-style-type: none">- You must not be treated with ORENCIA if you have severe infection.- You should be screened for certain infections prior to treatment with ORENCIA. <p>Tuberculosis (TB): You should be screened for TB prior to ORENCIA treatment. It is very important that you tell your doctor if you have ever had TB, or if you have been in close contact with someone who has had TB.</p> <p>Hepatitis: Anti-rheumatic therapies have been associated with hepatitis B reactivation. You should be screened for viral hepatitis in accordance with published guidelines.</p>	<p>Infections</p> <ul style="list-style-type: none">- If you develop symptoms suggestive of infections, such as fever, persistent cough, weight loss, or listlessness, seek medical attention immediately. <p>Allergic Reactions</p> <p>Allergic reactions may occur after the use of ORENCIA. If you experience symptoms such as chest tightness, wheezing, severe dizziness, or lightheadedness, seek medical attention immediately.</p> <p>Start of ORENCIA Treatment:</p> <p>_____</p> <ul style="list-style-type: none">• See the ORENCIA package leaflet for more information.• Please make sure you also have a list of all your other medicines with you at any visit to a health care professional. <p>Patient's Name: _____</p> <p>Doctor's Name: _____</p> <p>Doctor's Phone: _____</p> <p>Keep this card with you for 3 months after the last ORENCIA dose, since side effects may occur a long time after your last dose of ORENCIA.</p> <p>ORENCIA should not be used in pregnant women unless clearly necessary. If you have received ORENCIA while you were pregnant, it is important that you inform the baby's health care personnel before any vaccinations are given to your baby. Your baby may be at risk of severe infection caused by "live vaccines" for 14 weeks since your last ORENCIA administration.</p> <p style="text-align: right;">[Mmm YYYY]</p>
--	---

B. PACKAGE LEAFLET

Package leaflet: Information for the patient
ORENCIA 250 mg powder for concentrate for solution for infusion
abatacept

Read all of this leaflet carefully before you are given this medicine because it contains important information for you.

- Keep this leaflet. You may need to read it again.
- If you have any further questions, ask your doctor, pharmacist or nurse.
- If you get any side effects, talk to your doctor, pharmacist or nurse. This includes any possible side effects not listed in this leaflet. See section 4.

What is in this leaflet

1. What ORENCIA is and what it is used for
2. What you need to know before you are given ORENCIA
3. How to use ORENCIA
4. Possible side effects
5. How to store ORENCIA
6. Contents of the pack and other information

1. What ORENCIA is and what it is used for

ORENCIA contains the active substance abatacept, a protein produced in cell cultures. ORENCIA lessens the immune system's attack on normal tissues by interfering with the immune cells (called T lymphocytes) that contribute to the development of rheumatoid arthritis. ORENCIA selectively modulates the activation of T cells involved in the immune systems' inflammatory response.

ORENCIA is used to treat rheumatoid arthritis and psoriatic arthritis in adults and also polyarticular juvenile idiopathic arthritis in children 6 years of age and older.

Rheumatoid Arthritis

Rheumatoid arthritis is a long-term progressive systemic disease that, if untreated, can lead to serious consequences, such as joint destruction, increased disability and impairment of daily activities. In people with rheumatoid arthritis the body's own immune system attacks normal body tissues, leading to pain and swelling of the joints. This can cause joint damage. Rheumatoid arthritis (RA) affects everyone differently. In most people, joint symptoms develop gradually over several years. However, in some, RA may progress rapidly and yet other people may have RA for a limited period of time and then enter a period of remission. RA is usually a chronic (long-term), progressive disease. This means, even if you're on treatment, whether or not you're still having symptoms, RA could be continuing to damage your joints. By finding the right treatment plan for you, you may be able to slow down this disease process, which may help reduce long-term joint damage, as well as pain and fatigue and improve your overall quality of life.

ORENCIA is used to treat moderate to severe active rheumatoid arthritis when you do not respond well enough to treatment with other disease-modifying medicines or with another group of medicines called 'tumour necrosis factor (TNF) blockers'. It is used in combination with a medicine called methotrexate.

ORENCIA can also be used with methotrexate to treat highly active and progressive rheumatoid arthritis without previous methotrexate treatment.

Psoriatic Arthritis

Psoriatic arthritis is an inflammatory disease of the joints, usually accompanied by psoriasis, an inflammatory disease of the skin. If you have active psoriatic arthritis you will first be given other medicines. If you do not respond well enough to these medicines, you may be given ORENCIA to:

- Reduce the signs and symptoms of your disease.
- Slow down the damage to your bones and joints.
- Improve your physical function and your ability to do normal daily activities.

ORENCIA is used to treat psoriatic arthritis alone or in combination with methotrexate.

Polyarticular Juvenile Idiopathic Arthritis

Polyarticular juvenile idiopathic arthritis is a long-term inflammatory disease affecting one or more joints in children and adolescents.

ORENCIA powder for concentrate for solution for infusion is used in children and adolescents aged 6 to 17 years when a previous disease-modifying medicine has not worked well enough or is not suitable for them. ORENCIA is usually used in combination with methotrexate, although ORENCIA may also be used alone in case of intolerance to methotrexate or if treatment with methotrexate is inappropriate.

ORENCIA is used to:

- slow down the damage to joints
- improve physical function
- improve other signs and symptoms of polyarticular juvenile idiopathic arthritis

2. What you need to know before you are given ORENCIA

You should not be given ORENCIA

- **if you are allergic** to abatacept or any of the other ingredients of this medicine (listed in section 6).
- **if you have a severe or uncontrolled infection**, do not start treatment with ORENCIA. Having an infection could put you at risk of serious side effects from ORENCIA.

Warnings and precautions

Talk to your doctor, pharmacist or nurse:

- **if you experience allergic reactions** such as chest tightness, wheezing, severe dizziness or lightheadedness, swelling or skin rash **tell your doctor immediately**.
- if you, your partner or your caregiver notice **new onset or worsening of neurological symptoms** including general muscle weakness, disturbance of vision, difficulty speaking, a **change in the way you walk** or problem with your **balance, changes in thinking, memory and orientation** leading to confusion and personality changes **contact your doctor immediately** because these may be symptoms of a very rare, serious and potentially fatal brain infection called progressive multifocal leukoencephalopathy (PML).
- **if you have any kind of infection**, including long-term or localised infection, if you often get infections or **if you have symptoms of infection (e.g. fever, malaise, dental problems), it is important to tell your doctor**. ORENCIA can lower your body's ability to fight infection and the treatment can make you more likely to get infections or make any infection you have worse.
- **if you have had tuberculosis (TB)** or have symptoms of tuberculosis (persistent cough, weight loss, listlessness, mild fever) **tell your doctor**. Before you are given ORENCIA, your doctor will examine you for tuberculosis or do a skin test.
- **if you have viral hepatitis** tell your doctor. Before you are given ORENCIA, your doctor may examine you for hepatitis.
- **if you have cancer**, your doctor will decide if you can still be given ORENCIA.

- **if you recently had a vaccination** or are planning to have one, **tell your doctor**. Some vaccines should not be given while you are receiving ORENCIA. **Check with your doctor before you are given any vaccines**. It is recommended that patients with polyarticular juvenile idiopathic arthritis, if possible, be brought up to date with all immunisations in agreement with current immunisation guidelines prior to starting ORENCIA therapy. Certain vaccinations may cause infections from the vaccine. If you received ORENCIA while you were pregnant, your baby may be at a higher risk for getting such an infection for up to approximately 14 weeks after the last dose you received during pregnancy. It is important that you tell your baby's doctors and other health care professionals about your ORENCIA use during your pregnancy so they can decide when your baby should receive any vaccine.
- **if you are using a blood glucose monitor** to check your blood glucose levels. ORENCIA contains maltose, which is a type of sugar that can give falsely high blood glucose readings with certain types of blood glucose monitors. Your doctor may recommend a different method for monitoring your blood glucose levels.

Your doctor may also do tests to examine your blood values.

Children and adolescents

ORENCIA powder for concentrate for solution for infusion has not been studied in children and adolescents under 6 years of age, therefore ORENCIA powder for concentrate for infusion is not recommended for use in this patient population.

ORENCIA solution for injection pre-filled syringe is available for subcutaneous administration for paediatric patients 2 years of age and older.

Other medicines and ORENCIA

Tell your doctor if you are taking, have recently taken or might take any other medicines.

ORENCIA should not be used with biological medicines for rheumatoid arthritis, including TNF-blockers like adalimumab, etanercept, and infliximab; there is not enough evidence to recommend its being given with anakinra and rituximab.

ORENCIA can be received with other medicines commonly used to treat rheumatoid arthritis, such as steroids or painkillers, including non-steroidal anti-inflammatories such as ibuprofen or diclofenac. Ask your doctor or pharmacist for advice before taking any other medicine while using ORENCIA.

Pregnancy and breast-feeding

The effects of ORENCIA in pregnancy are not known, so you should not be given ORENCIA if you are pregnant unless your doctor specifically recommends it.

- if you are a woman who could become pregnant, you must use reliable contraception (birth control) while using ORENCIA and up to 14 weeks after the last dose. Your doctor will advise you on suitable methods.
- if you become pregnant while using ORENCIA, tell your doctor.

If you received ORENCIA during your pregnancy, your baby may have a higher risk for getting an infection. It is important that you tell your baby's doctors and other health care professionals about your ORENCIA use during your pregnancy before the baby receives any vaccine (for more information see section on vaccination).

It is not known whether ORENCIA passes into human milk. **You must stop breast-feeding** if you are being treated with ORENCIA and for up to 14 weeks after the last dose.

Driving and using machines

The use of ORENCIA is not expected to affect the ability to drive, cycle or use machines. However, if you are feeling tired or unwell after receiving ORENCIA, you should not drive, cycle or operate any machinery.

ORENCIA contains sodium

This medicine contains 34.5 mg sodium (main component of cooking/table salt) per maximum dose of 4 vials (8.625 mg sodium per vial). This is equivalent to 1.7% of the recommended maximum daily dietary intake of sodium for an adult.

3. How to use ORENCIA

ORENCIA will be given to you under the supervision of an experienced doctor.

Recommended dose in adults

The recommended dose of abatacept for adults with rheumatoid arthritis or psoriatic arthritis is based on body weight:

Your weight	Dose	Vials
Less than 60 kg	500 mg	2
60 kg - 100 kg	750 mg	3
More than 100 kg	1,000 mg	4

Your doctor will advise you on the duration of treatment and what other medicines, including other disease-modifying medicines, if any, you may continue to take while on ORENCIA.

ORENCIA can be used by adults over 65 with no change in dose.

Use in children and adolescents

For children and adolescents aged 6 to 17 years with polyarticular juvenile idiopathic arthritis who weigh less than 75 kg, the recommended dose of intravenous abatacept is 10 mg/kg. Children weighing 75 kg or more should be administered ORENCIA powder for concentrate for solution for infusion following the adult dosing regimen.

How ORENCIA is given to you

ORENCIA is given to you into a vein, usually in your arm, over a period of 30 minutes. This procedure is referred to as an infusion. Healthcare professionals will monitor you while you receive your ORENCIA infusion.

ORENCIA is supplied as a powder for solution for infusion. This means that before ORENCIA is given to you, it is first dissolved in water for injections, then further diluted with sodium chloride 9 mg/mL (0.9%) solution for injection.

How often ORENCIA is given to you

ORENCIA should be given to you again, 2 and then 4 weeks after the first infusion. After that you will receive a dose every 4 weeks. Your doctor will advise you on the duration of treatment and what other medicines you may continue to take while on ORENCIA.

If you are given more ORENCIA than you should

If this happens, your doctor will monitor you for any signs or symptoms of side effects, and treat these symptoms if necessary.

If you forget to receive ORENCIA

If you miss receiving ORENCIA when you are supposed to, ask your doctor when to schedule your next dose.

If you stop using ORENCIA

The decision to stop using ORENCIA should be discussed with your doctor.

If you have any further questions on the use of this medicine, ask your doctor, pharmacist or nurse.

4. Possible side effects

Like all medicines, this medicine can cause side effects, although not everybody gets them. The most common side effects with ORENCIA are infections of the upper airway (including infections of the nose and throat), headache and nausea, as listed below. ORENCIA can cause serious side effects, which may need treatment.

Possible serious side effects include serious infections, malignancies (cancer) and allergic reactions, as listed below.

Tell your doctor immediately if you notice any of the following:

- severe rash, hives or other signs of allergic reaction
- swollen face, hands or feet
- trouble breathing or swallowing
- fever, persistent cough, weight loss, listlessness

Tell your doctor as soon as possible if you notice any of the following:

- feeling generally unwell, dental problems, burning sensation during urination, painful skin rash, painful skin blisters, coughing

The symptoms described above can be signs of the side effects listed below, all of which have been observed with ORENCIA in adult clinical trials:

Very common (may affect more than 1 in 10 people):

- infections of the upper airway (including infections of the nose, throat and sinuses).

Common (may affect up to 1 in 10 people):

- infections of lungs, urinary infections, painful skin blisters (herpes), flu
- headache, dizziness
- high blood pressure
- cough
- abdominal pain, diarrhoea, nausea, upset stomach, mouth sores, vomiting
- rash
- fatigue, weakness
- abnormal liver function tests

Uncommon (may affect up to 1 in 100 people):

- tooth infection, nail fungal infection, infection in the muscles, blood stream infection, collection of pus under the skin, kidney infection, ear infection
- low white blood cells count
- skin cancer, skin warts
- low blood platelet count
- allergic reactions
- depression, anxiety, sleep disturbance
- migraine
- numbness
- dry eye, reduced vision
- eye inflammation
- palpitation, rapid heart rate, low heart rate
- low blood pressure, hot flush, blood vessels inflammation, flushing
- difficulty in breathing, wheezing, shortness of breath, acute worsening of a lung disease called chronic obstructive pulmonary disease (COPD)
- throat tightness
- rhinitis
- increased tendency to bruise, dry skin, psoriasis, skin redness, excessive sweating, acne

- hair loss, itching, hives
- painful joints
- pain in the extremities
- absence of menstruation, excessive menses
- flu-like illness, increased weight, infusion-related reactions

Rare (may affect up to 1 in 1,000 people):

- tuberculosis
- inflammation of uterus, fallopian tubes and/or ovaries
- gastrointestinal infection
- cancer of white blood cells, lung cancer

Children and adolescents with polyarticular juvenile idiopathic arthritis

The side effects experienced in children and adolescents with polyarticular juvenile idiopathic arthritis are similar to those experienced in adults as described above, with the following differences:

Common (may affect up to 1 in 10 people):

- upper airway infection (including infections of nose, sinus and throat)
- fever

Uncommon (may affect up to 1 in 100 people):

- blood in urine
- ear infection

Reporting of side effects

If you get any side effects, talk to your doctor, pharmacist or nurse. This includes any possible side effects not listed in this leaflet. You can also report side effects directly via [the national reporting system listed in Appendix V](#). By reporting side effects you can help provide more information on the safety of this medicine.

5. How to store ORENCIA

Keep this medicine out of the sight and reach of children.

Do not use this medicine after the expiry date which is stated on the label and the carton after EXP. The expiry date refers to the last day of that month.

Store in a refrigerator (2°C - 8°C).

Store in the original package in order to protect from light.

After reconstitution and dilution, the infusion solution is stable for 24 hours in a refrigerator, but for bacteriological reasons, it is to be used immediately.

Do not use this medicine if you notice opaque particles, discolouration or other foreign particles present in the infusion solution.

Do not throw away any medicines via wastewater or household waste. Ask your pharmacist how to throw away medicines you no longer use. These measures will help to protect the environment.

6. Contents of the pack and other information

What ORENCIA contains

- The active substance is abatacept. Each vial contains 250 mg of abatacept.

- After reconstitution, each mL contains 25 mg of abatacept.
- The other ingredients are maltose, sodium dihydrogen phosphate monohydrate and sodium chloride (see section 2 "ORENCIA contains sodium").

What ORENCIA looks like and contents of the pack

ORENCIA powder for concentrate for solution for infusion is a white to off-white powder that can appear solid or broken into pieces.

ORENCIA is available in packs of 1 vial and 1 silicone-free syringe, and in multipacks containing 2, or 3 vials and 2, or 3 silicone-free syringes (2 or 3 packs of 1).

Not all pack sizes may be marketed.

Marketing Authorisation Holder

Bristol-Myers Squibb Pharma EEIG
Plaza 254
Blanchardstown Corporate Park 2
Dublin 15, D15 T867
Ireland

Manufacturer

CATALENT ANAGNI S.R.L.
Loc. Fontana del Ceraso snc
Strada Provinciale 12 Casilina, 41
03012 Anagni (FR)
Italy

Swords Laboratories Unlimited Company t/a Bristol-Myers Squibb Cruiserath Biologics
Cruiserath Road, Mulhuddart
Dublin 15
Ireland

This leaflet was last revised in

Other sources of information

Detailed information on this medicine is available on the European Medicines Agency web site:
<http://www.ema.europa.eu>.

The following information is intended for healthcare professionals only

Reconstitution and dilution should be performed in accordance with good practices rules, particularly with respect to asepsis.

Dose selection: see section 3 'How to use ORENCIA' of the Package Leaflet

Reconstitution of vials: under aseptic conditions, reconstitute each vial with 10 mL of water for injections, using the **silicone-free disposable syringe provided with each vial** and an 18-21 gauge needle. Remove the flip-top from the vial and wipe the top with an alcohol swab. Insert the syringe needle into the vial through the centre of the rubber stopper and direct the stream of water for injections to the glass wall of the vial. Do not use the vial if a vacuum is not present. Remove the syringe and needle after 10 mL of water for injections have been injected into the vial. To minimise foam formation in solutions of ORENCIA the vial should be rotated with gentle swirling until the contents are completely dissolved. **Do not shake. Do not use prolonged or vigorous agitation.** Upon complete dissolution of the powder, the vial should be vented with a needle to dissipate any foam that may be present. After reconstitution the solution should be clear and colourless to pale yellow. Do not use if opaque particles, discolouration, or other foreign particles are present.

Preparation of infusion: immediately after reconstitution, dilute the concentrate to 100 mL with sodium chloride 9 mg/mL (0.9%) solution for injection. From a 100 mL infusion bag or bottle, withdraw a volume of 0.9% sodium chloride injection equal to the volume of the reconstituted ORENCIA vials. Slowly add the reconstituted ORENCIA solution from each vial to the infusion bag or bottle using the same **silicone-free disposable syringe provided with each vial**. Gently mix. The final concentration of abatacept in the bag or bottle will depend upon the amount of active substance added, but will be no more than 10 mg/mL.

Administration: when reconstitution and dilution are performed under aseptic conditions ORENCIA infusion solution can be used immediately or within 24 hours if stored refrigerated at 2°C to 8°C. However, for microbiological reasons, it is to be used immediately. Prior to administration, the ORENCIA solution should be inspected visually for particulate matter and discolouration. Discard the solution if any particulate matter or discolouration is observed. The entire, fully diluted ORENCIA solution should be administered over a period of 30 minutes and must be administered with an infusion set and a sterile, non-pyrogenic, low-protein-binding filter (pore size of 0.2 to 1.2 µm). Do not store any unused portion of the infusion solution for reuse.

Other medicines: ORENCIA should not be mixed with other medicines or infused concomitantly in the same intravenous line with other medicines. No physical or biochemical compatibility studies have been conducted to evaluate the co-administration of ORENCIA with other medicines.

Do not throw away any medicines via wastewater or household waste. Ask your pharmacist how to throw away medicines you no longer use. These measures will help to protect the environment.

Package leaflet: Information for the patient
ORENCIA 50 mg solution for injection in pre-filled syringe
ORENCIA 87.5 mg solution for injection in pre-filled syringe
ORENCIA 125 mg solution for injection in pre-filled syringe
abatacept

Read all of this leaflet carefully before you start using this medicine because it contains important information for you.

- Keep this leaflet. You may need to read it again.
- If you have any further questions, ask your doctor, pharmacist or nurse.
- This medicine has been prescribed for you only. Do not pass it on to others. It may harm them, even if their signs of illness are the same as yours.
- If you get any side effects, talk to your doctor, pharmacist or nurse. This includes any possible side effects not listed in this leaflet. See section 4.

What is in this leaflet

1. What ORENCIA is and what it is used for
2. What you need to know before you use ORENCIA
3. How to use ORENCIA
4. Possible side effects
5. How to store ORENCIA
6. Contents of the pack and other information

1. What ORENCIA is and what it is used for

ORENCIA contains the active substance abatacept, a protein produced in cell cultures. ORENCIA lessens the immune system's attack on normal tissues by interfering with the immune cells (called T lymphocytes) that contribute to the development of rheumatoid arthritis. ORENCIA selectively modulates the activation of T cells involved in the immune system's inflammatory response.

ORENCIA is used to treat rheumatoid arthritis and psoriatic arthritis in adults and also polyarticular juvenile idiopathic arthritis in children 2 years of age and older.

Rheumatoid Arthritis

Rheumatoid arthritis is a long-term progressive systemic disease that, if untreated, can lead to serious consequences, such as joint destruction, increased disability and impairment of daily activities. In people with rheumatoid arthritis the body's own immune system attacks normal body tissues, leading to pain and swelling of the joints. This can cause joint damage. Rheumatoid arthritis (RA) affects everyone differently. In most people, joint symptoms develop gradually over several years. However, in some, RA may progress rapidly and yet other people may have RA for a limited period of time and then enter a period of remission. RA is usually a chronic (long-term), progressive disease. This means, even if you're on treatment, whether or not you're still having symptoms, RA could be continuing to damage your joints. By finding the right treatment plan for you, you may be able to slow down this disease process, which may help reduce long-term joint damage, as well as pain and fatigue and improve your overall quality of life.

ORENCIA is used to treat moderate to severe active rheumatoid arthritis when you do not respond well enough to treatment with other disease-modifying medicines or with another group of medicines called 'tumour necrosis factor (TNF) blockers'. It is used in combination with a medicine called methotrexate.

ORENCIA can also be used with methotrexate to treat highly active and progressive rheumatoid arthritis without previous methotrexate treatment.

ORENCIA is used to:

- slow down the damage to your joints
- improve your physical function

Psoriatic Arthritis

Psoriatic arthritis is an inflammatory disease of the joints, usually accompanied by psoriasis, an inflammatory disease of the skin. If you have active psoriatic arthritis you will first be given other medicines. If you do not respond well enough to these medicines, you may be given ORENCIA to:

- Reduce the signs and symptoms of your disease.
- Slow down the damage to your bones and joints.
- Improve your physical function and your ability to do normal daily activities.

ORENCIA is used to treat psoriatic arthritis alone or in combination with methotrexate.

Polyarticular Juvenile Idiopathic Arthritis

Polyarticular juvenile idiopathic arthritis is a long-term inflammatory disease affecting one or more joints in children and adolescents.

ORENCIA solution for injection in pre-filled syringe is used in children and adolescents aged 2 to 17 years when a previous disease-modifying medicine has not worked well or is not suitable for them. ORENCIA is usually used in combination with methotrexate, although ORENCIA may also be used alone if treatment with methotrexate is inappropriate.

ORENCIA is used to:

- slow down the damage to joints
- improve physical function
- improve other signs and symptoms of polyarticular juvenile idiopathic arthritis

2. What you need to know before you use ORENCIA

Do not use ORENCIA

- **if you are allergic** to abatacept or any of the other ingredients of this medicine (listed in section 6).
- **if you have a severe or uncontrolled infection**, do not start treatment with ORENCIA. Having an infection could put you at risk of serious side effects from ORENCIA.

Warnings and precautions

Talk to your doctor, pharmacist or nurse:

- **if you experience allergic reactions** such as chest tightness, wheezing, severe dizziness or lightheadedness, swelling or skin rash **tell your doctor immediately**.
- if you, your partner or your caregiver notice **new onset or worsening of neurological symptoms** including general muscle weakness, disturbance of vision, difficulty speaking, a **change in the way you walk** or problem with your **balance, changes in thinking, memory and orientation** leading to confusion and personality changes **contact your doctor immediately** because these may be symptoms of a very rare, serious and potentially fatal brain infection called progressive multifocal leukoencephalopathy (PML).
- **if you have any kind of infection**, including long-term or localised infection, if you often get infections or **if you have symptoms of infection (e.g. fever, malaise, dental problems), it is important to tell your doctor**. ORENCIA can lower your body's ability to fight infection and the treatment can make you more likely to get infections or make any infection you have worse.
- **if you have had tuberculosis (TB)** or have symptoms of tuberculosis (persistent cough, weight loss, listlessness, mild fever) **tell your doctor**. Before you use ORENCIA, your doctor will examine you for tuberculosis or do a skin test.

- **if you have viral hepatitis** tell your doctor. Before you use ORENCIA, your doctor may examine you for hepatitis.
- **if you have cancer**, your doctor will decide if you can still be given ORENCIA.
- **if you recently had a vaccination** or are planning to have one, **tell your doctor**. Some vaccines should not be given while you are receiving ORENCIA. **Check with your doctor before you are given any vaccines**. Certain vaccinations may cause infections from the vaccine. If you received ORENCIA while you were pregnant, your baby may be at a higher risk for getting such an infection for up to approximately 14 weeks after the last dose you received during pregnancy. It is important that you tell your baby's doctors and other health care professionals about your ORENCIA use during your pregnancy so they can decide when your baby should receive any vaccine.

Your doctor may also do tests to examine your blood values.

Children and adolescents

ORENCIA solution for injection in pre-filled syringe has not been studied in children and adolescents under 2 years of age. Therefore, ORENCIA solution for injection in pre-filled syringe is not recommended for use in this patient population.

Other medicines and ORENCIA

Tell your doctor if you are taking, have recently taken or might take any other medicines.

ORENCIA should not be used with biological medicines for rheumatoid arthritis, including TNF-blockers like adalimumab, etanercept, and infliximab; there is not enough evidence to recommend its being given with anakinra and rituximab.

ORENCIA can be used with other medicines commonly used to treat rheumatoid arthritis, such as steroids or painkillers, including non-steroidal anti-inflammatories such as ibuprofen or diclofenac. Ask your doctor or pharmacist for advice before taking any other medicine while using ORENCIA.

Pregnancy and breast-feeding

The effects of ORENCIA in pregnancy are not known, so do not use ORENCIA if you are pregnant unless your doctor specifically recommends it.

- if you are a woman who could become pregnant, you must use reliable contraception (birth control) while using ORENCIA and up to 14 weeks after the last dose. Your doctor will advise you on suitable methods.
- if you become pregnant while using ORENCIA, tell your doctor.

If you received ORENCIA during your pregnancy, your baby may have a higher risk for getting an infection. It is important that you tell your baby's doctors and other health care professionals about your ORENCIA use during your pregnancy before the baby receives any vaccine (for more information see section on vaccination).

It is not known whether ORENCIA passes into human milk. **You must stop breast-feeding** if you are being treated with ORENCIA and for up to 14 weeks after the last dose.

Driving and using machines

The use of ORENCIA is not expected to affect the ability to drive, cycle or use machines. However, if you are feeling tired or unwell after receiving ORENCIA, you should not drive, cycle or operate any machinery.

ORENCIA contains sodium

This medicine contains less than 1 mmol sodium (23 mg) per dose, that is to say essentially 'sodium-free'.

3. How to use ORENCIA

Always use this medicine exactly as your doctor or pharmacist has told you. Check with your doctor or pharmacist if you are not sure.

ORENCIA solution for injection is injected under the skin (subcutaneous use).

Recommended dose in adults

The recommended dose of ORENCIA for adults with rheumatoid arthritis or psoriatic arthritis is 125 mg given every week regardless of weight.

Your doctor may start your ORENCIA treatment with or without a one-time dose of powder for concentrate for solution for infusion (given to you into a vein, usually in your arm, over a period of 30 minutes). If a single intravenous dose is given to start the treatment, the first subcutaneous injection of ORENCIA should be given within a day of the intravenous infusion, followed by the weekly 125 mg subcutaneous injections.

ORENCIA can be used by adults over 65 with no change in dose.

Use in children and adolescents

For patients 2 to 17 years of age with polyarticular juvenile idiopathic arthritis, the recommended weekly dose of ORENCIA solution for injection in pre-filled syringe is based on body weight:

Weekly Dose of ORENCIA	
Body Weight of Patient	Dose
10 kg to less than 25 kg	50 mg
25 kg to less than 50 kg	87.5 mg
50 kg or more	125 mg

If you are already on intravenous ORENCIA treatment and wish to transition to ORENCIA subcutaneous, you should receive a subcutaneous injection instead of your next intravenous infusion, followed by weekly subcutaneous injections of ORENCIA.

Your doctor will advise you on the duration of treatment and what other medicines, including other disease-modifying medicines, if any, you may continue to take while on ORENCIA.

At the start, your doctor or nurse may inject ORENCIA. However, you and your doctor may decide that you can inject ORENCIA yourself. In this case, you will get training on how to inject ORENCIA yourself.

Talk to your doctor if you have any questions about giving yourself an injection. You will find detailed instructions for the preparation and administration of ORENCIA at the end of this leaflet (see "**Important instructions for use**").

If you use more ORENCIA than you should

If this happens, contact immediately your doctor who will monitor you for any signs or symptoms of side effects, and treat these symptoms if necessary.

If you forget to use ORENCIA

Keep track of your next dose. It is very important to use ORENCIA exactly as prescribed by your doctor. If you miss your dose within three days of when you are supposed to take it, take your dose as soon as you remember and then follow your original dosing schedule on your chosen day. If you miss your dose by more than three days, ask your doctor when to take your next dose.

If you stop using ORENCIA

The decision to stop using ORENCIA should be discussed with your doctor.

If you have any further questions on the use of this medicine, **ask your doctor, pharmacist or nurse.**

4. Possible side effects

Like all medicines, this medicine can cause side effects, although not everybody gets them. The most common side effects with ORENCIA are infections of the upper airway (including infections of the nose and throat), headache and nausea, as listed below. ORENCIA can cause serious side effects, which may need treatment.

Possible serious side effects include serious infections, malignancies (cancer) and allergic reactions, as listed below.

Tell your doctor immediately if you notice any of the following:

- severe rash, hives or other signs of allergic reaction
- swollen face, hands or feet
- trouble breathing or swallowing
- fever, persistent cough, weight loss, listlessness

Tell your doctor as soon as possible if you notice any of the following:

- feeling generally unwell, dental problems, burning sensation during urination, painful skin rash, painful skin blisters, coughing

The symptoms described above can be signs of the side effects listed below, all of which have been observed with ORENCIA in adult clinical trials:

List of side effects:

Very common (may affect more than 1 in 10 people):

- infections of the upper airway (including infections of the nose, throat and sinuses).

Common (may affect up to 1 in 10 people):

- infections of lungs, urinary infections, painful skin blisters (herpes), flu
- headache, dizziness
- high blood pressure
- cough
- abdominal pain, diarrhoea, nausea, upset stomach, mouth sores, vomiting
- rash
- fatigue, weakness, injection site reactions
- abnormal liver function tests

Uncommon (may affect up to 1 in 100 people):

- tooth infection, nail fungal infection, infection in the muscles, blood stream infection, collection of pus under the skin, kidney infection, ear infection
- low white blood cells count
- skin cancer, skin warts
- low blood platelet count
- allergic reactions
- depression, anxiety, sleep disturbance
- migraine
- numbness
- dry eye, reduced vision
- eye inflammation
- palpitation, rapid heart rate, low heart rate
- low blood pressure, hot flush, blood vessels inflammation, flushing
- difficulty in breathing, wheezing, shortness of breath, acute worsening of a lung disease called chronic obstructive pulmonary disease (COPD)

- throat tightness
- rhinitis
- increased tendency to bruise, dry skin, psoriasis, skin redness, excessive sweating, acne
- hair loss, itching, hives
- painful joints
- pain in the extremities
- absence of menstruation, excessive menses
- flu-like illness, increased weight

Rare (may affect up to 1 in 1,000 people):

- tuberculosis
- inflammation of uterus, fallopian tubes and/or ovaries
- gastrointestinal infection
- cancer of white blood cells, lung cancer

Children and adolescents with polyarticular juvenile idiopathic arthritis

The side effects experienced in children and adolescents with polyarticular juvenile idiopathic arthritis are similar to those experienced in adults as described above with the following differences:

Common (may affect up to 1 in 10 people):

- upper airway infection (including infections of nose, sinus and throat)
- fever

Uncommon (may affect up to 1 in 100 people):

- blood in urine
- ear infection

Reporting of side effects

If you get any side effects, talk to your doctor, pharmacist or nurse. This includes any possible side effects not listed in this leaflet. You can also report side effects directly via **the national reporting system listed in Appendix V**. By reporting side effects you can help provide more information on the safety of this medicine.

5. How to store ORENCIA

Keep this medicine out of the sight and reach of children.

Do not use this medicine after the expiry date which is stated on the label and the carton after EXP. The expiry date refers to the last day of that month.

Store in a refrigerator (2°C to 8°C). Do not freeze.

Store in the original package in order to protect from light.

Do not use this medicine if the liquid is cloudy or discoloured, or has large particles. The liquid should be clear to pale yellow.

Do not throw away any medicines via wastewater or household waste. Ask your pharmacist how to throw away medicines you no longer use. These measures will help to protect the environment.

6. Contents of the pack and other information

What ORENCIA contains

ORENCIA 50 mg solution for injection in pre-filled syringe

- The active substance is abatacept.
- Each pre-filled syringe contains 50 mg of abatacept in 0.4 mL.

ORENCIA 87.5 mg solution for injection in pre-filled syringe

- The active substance is abatacept.
- Each pre-filled syringe contains 87.5 mg of abatacept in 0.7 mL.

ORENCIA 125 mg solution for injection in pre-filled syringe

- The active substance is abatacept.
- Each pre-filled syringe contains 125 mg of abatacept in one mL.
- The other ingredients are sucrose, poloxamer 188, sodium dihydrogen phosphate monohydrate, disodium phosphate anhydrous, and water for injections (see section 2 "ORENCIA contains sodium").

What ORENCIA looks like and contents of the pack

ORENCIA solution for injection (injection) is a clear, colourless to pale yellow solution.

ORENCIA is available in the following presentations:

ORENCIA 50 mg solution for injection in pre-filled syringe with white plunger

- pack of 4 pre-filled syringes with needle guard.

ORENCIA 87.5 mg solution for injection in pre-filled syringe with light blue plunger

- pack of 4 pre-filled syringes with needle guard.

ORENCIA 125 mg solution for injection in pre-filled syringe with orange plunger

- packs of 1 or 4 pre-filled syringes and multipack containing 12 pre-filled syringes (3 packs of 4).
- packs of 1, 3, or 4 pre-filled syringes with needle guard and multipack containing 12 pre-filled syringes with needle guard (3 packs of 4).

Not all pack sizes may be marketed.

Marketing Authorisation Holder

Bristol-Myers Squibb Pharma EEIG
Plaza 254
Blanchardstown Corporate Park 2
Dublin 15, D15 T867
Ireland

Manufacturer

CATALENT ANAGNI S.R.L.
Loc. Fontana del Ceraso snc
Strada Provinciale 12 Casilina, 41
03012 Anagni (FR)
Italy

Swords Laboratories Unlimited Company t/a Bristol-Myers Squibb Cruiserath Biologics
Cruiserath Road, Mulhuddart
Dublin 15
Ireland

This leaflet was last revised in

Other sources of information

Detailed information on this medicine is available on the European Medicines Agency web site:

<http://www.ema.europa.eu>.

Important instructions for use. Read carefully.

HOW TO USE

ORENCIA 50 mg

ORENCIA 87.5 mg

ORENCIA 125 mg

solution for injection in pre-filled syringe with needle guard

Abatacept

Subcutaneous use

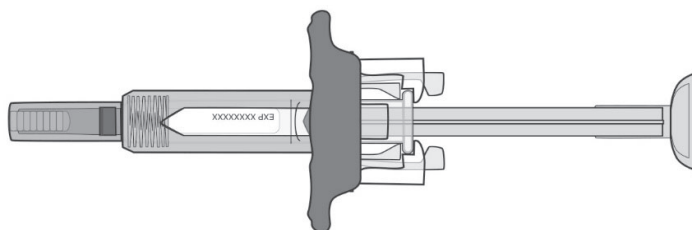

Read these instructions before you use the ORENCIA pre-filled syringe.

Before you use the pre-filled syringe for the first time, make sure your doctor, nurse or pharmacist shows you the right way to use it.

Keep refrigerated until ready to use. DO NOT FREEZE.

If you have questions about this product, please read the Package Leaflet.

BEFORE YOU BEGIN:

Get to know your Pre-filled Syringe

There are **3 types** of pre-filled syringes:

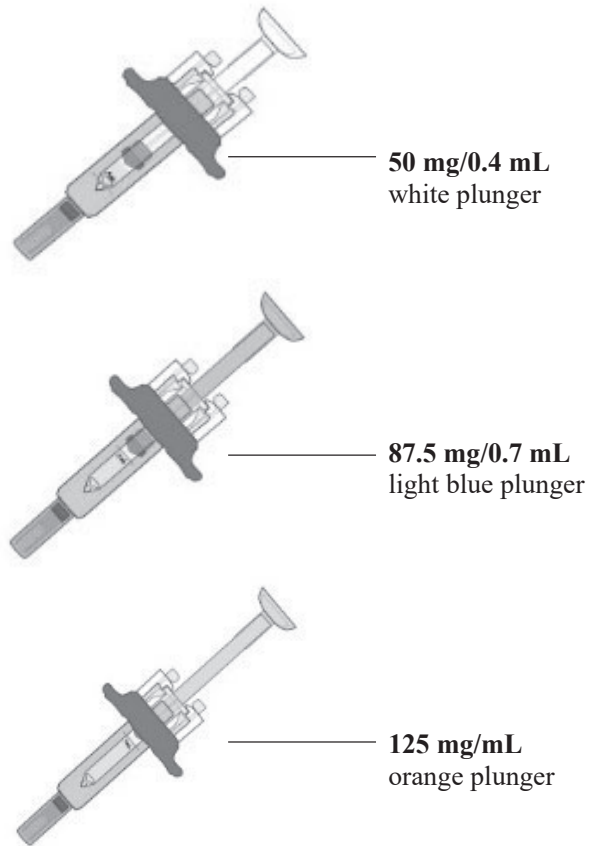

The type of pre-filled syringe you receive depends on the dose prescribed by your doctor. The 125 mg/mL pre-filled syringe is shown below.

Before Use

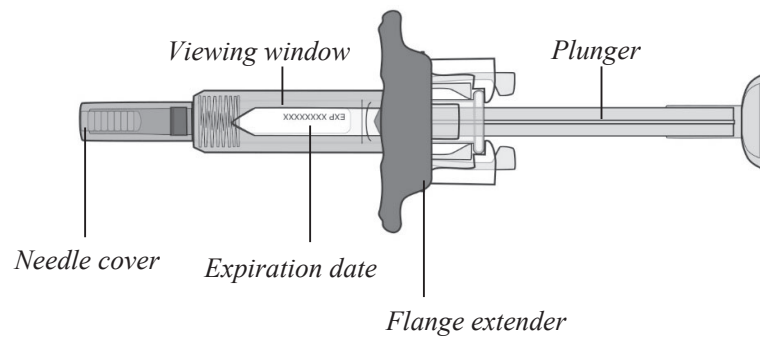

After Use

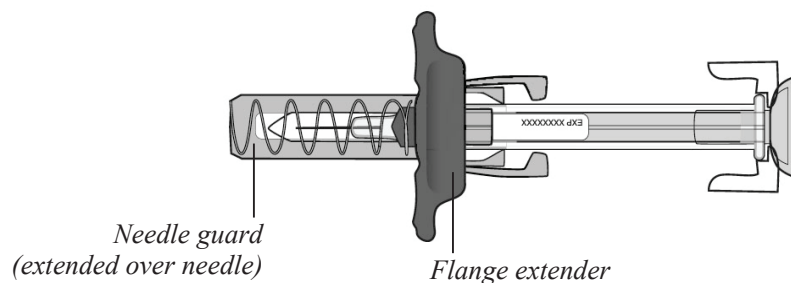

The pre-filled syringe has a **flange extender** that makes it easier to hold and inject, and a **needle guard** that automatically covers the needle after a complete injection.



DO NOT remove the needle cover until you are ready to inject.

DO NOT PULL back the plunger at any time.

DO NOT RECAP the pre-filled syringe at any time, as this may damage, bend, or break the needle. Always hold the syringe by its body.

Proceed to Step 1

Step 1: Preparing for an ORENCIA Injection

Gather supplies for your injection on a clean, flat surface.

Only the pre-filled syringe is included in the package:

- Alcohol swab



- Adhesive plaster



- Cotton ball or gauze



- Pre-filled syringe with UltraSafe Passive Needle guard



- Sharps disposal container

Let your Pre-filled syringe warm up.

Remove one pre-filled syringe from the refrigerator and wait **30 minutes** to allow it to reach room temperature.

- **Do not** speed up the warming process in any way, such as using the microwave or placing the syringe in warm water.
- **Do not** remove the needle cover while allowing the pre-filled syringe to reach room temperature.

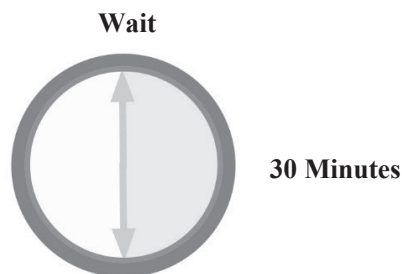

Wash your hands well with soap and water to prepare for injection.

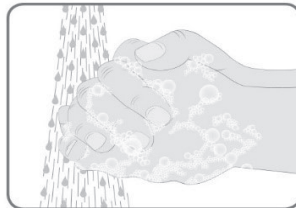

Proceed to Step 2

Step 2: Examine the Pre-filled syringe

Hold the pre-filled syringe by the body with the needle cover pointing down as shown.

- Check the expiry date printed on the label.
Do not use if the expiry date has passed.
- Check the pre-filled syringe for damage.
Do not use if it is cracked or broken.

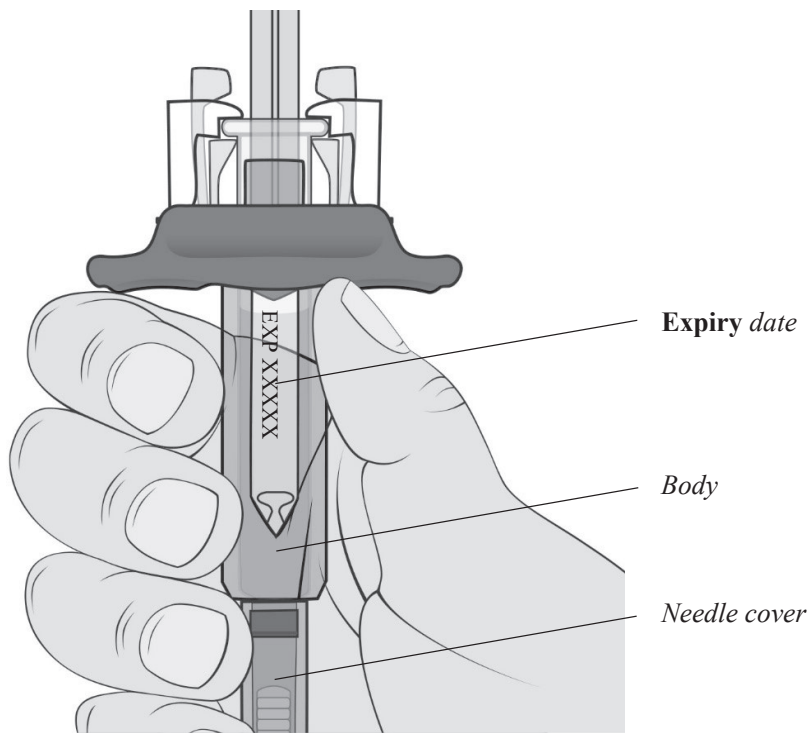

Check the liquid

Check the liquid in the pre-filled syringe through the viewing window. It should be clear and colourless to pale yellow.

You may see a small air bubble. **Do not** attempt to remove it.

Do not inject if the liquid is cloudy, discoloured, or has particles.

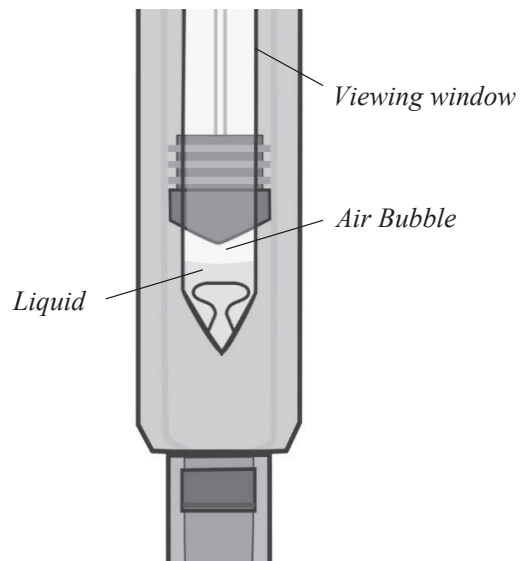

Note: the figure shows the 50 mg pre-filled syringe

Proceed to Step 3

Step 3: Check the Dose on the Pre-filled Syringe

Hold the syringe at eye level. Look closely to make sure that the amount of liquid in the pre-filled syringe is **at or just above the fill line** for your prescribed dose:

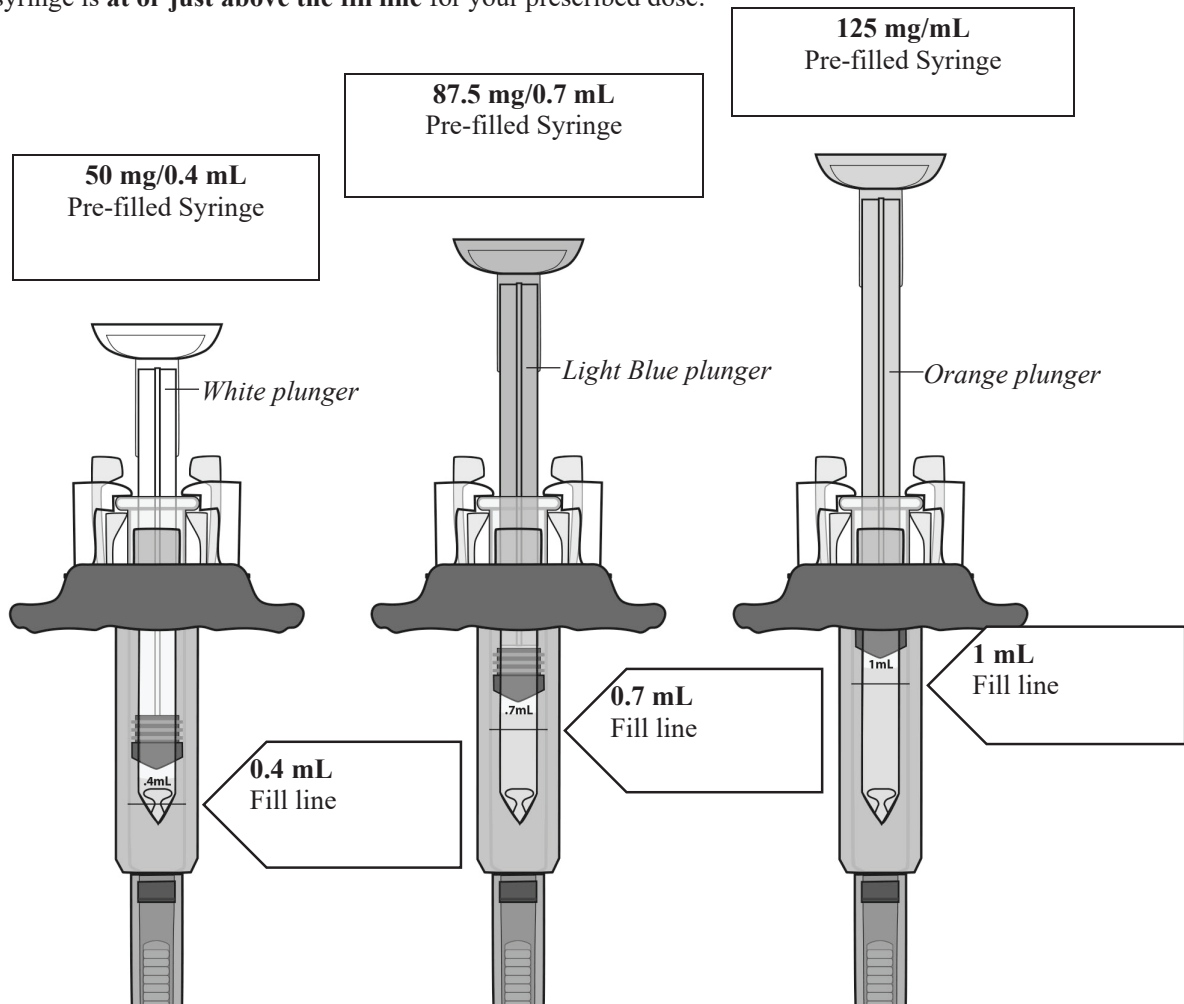

Do not use if your pre-filled syringe does not have the correct amount of liquid. Contact your doctor, nurse, or pharmacist for further instructions.

Proceed to Step 4

Step 4: Choose and Prepare an Injection Site

Choose your injection site in either the **abdomen**, front of the **thighs**, or outer area of **upper arm** (only if caregiver administered).

Change injection site

- Each week you can use the same area of your body, but use a different injection site in that area.
- **Do not** inject into an area where the skin is tender, bruised, red, scaly, or hard.
- **Do not** give the injection in any areas with scars or stretch marks.
- Record the date, time, and site where you inject.

Injection Areas Self-Injection and Caregiver

*Abdomen, avoid 5 cm around
navel*

Front of thighs

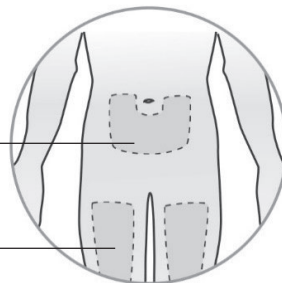

Caregiver ONLY

Outer area of upper arms

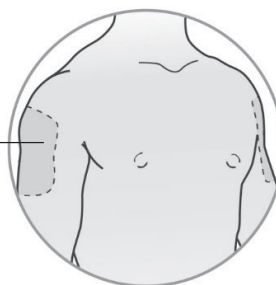

Gently clean injection site

- Wipe the injection site with an alcohol swab and let your skin dry.
- **Do not** touch the injection site again before giving the injection.
- **Do not** fan or blow on the clean area.

Remove the needle cover by holding the body of the pre-filled syringe with one hand and pulling the cover straight off with your other hand.

Do not put the needle cover back on the needle after you remove it. You can discard the cap in your household waste after the injection.

- **Do not** use the pre-filled syringe if it is dropped after the needle cover is removed.
- **Do not** use the pre-filled syringe if the needle is damaged or bent.

Note: It is normal to see a drop of fluid leaving the needle.

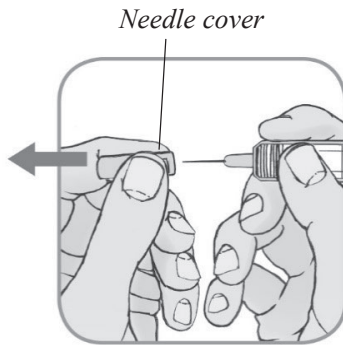

DO NOT RECAP the Pre-filled Syringe, as this may damage the needle.

Proceed to Step 5

Step 5: Inject Your Dose of ORENCIA

Hold the body of the pre-filled syringe in your hand using your thumb and index finger. With your other hand, **pinch the cleaned skin**.

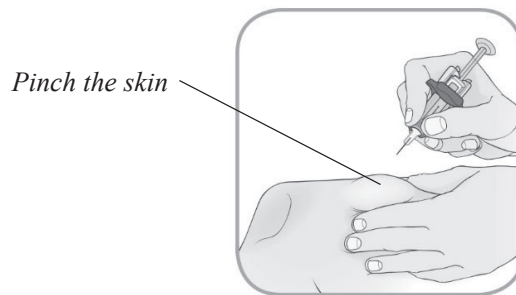

Insert the needle

Gently insert the needle into the pinched skin at a 45° angle.



Complete ALL steps to deliver your full dose of the medicine

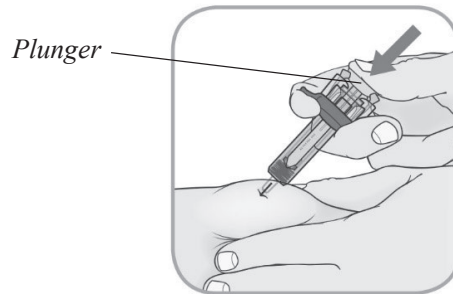

Inject: push the plunger with your thumb as far as it will go.

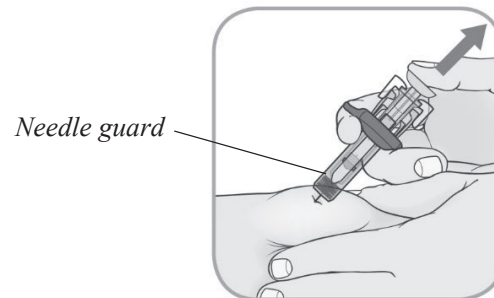

Release Needle Guard: slowly lift your thumb from the plunger to activate the needle guard.

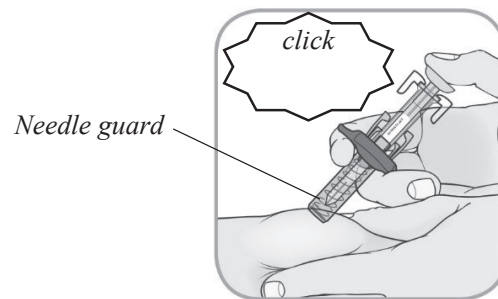

Confirm: after a complete injection, the needle guard will cover the needle and you may hear a click.

Remove the pre-filled syringe from the injection site and let go of the pinched skin.

Proceed to Step 6

Step 6: After the Injection

Care of injection site:

- There may be a little bleeding at the injection site. You can press a cotton ball or gauze over the injection site.
- **Do not** rub the injection site.
- If needed, you may cover the injection site with an adhesive plaster.

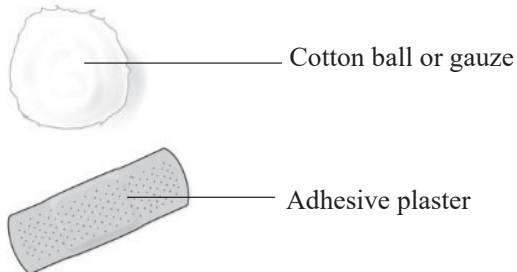

Dispose of the used pre-filled syringe into sharps disposal container right away after use. Should you have any questions, ask your pharmacist.

See the **Package Leaflet** for additional disposal information.

If your injection is administered by a caregiver, this person must also handle the syringe carefully to prevent accidental needle stick injury and possibly spreading infection.

Keep this medicine and the disposal container out of the sight and reach of children.

Important instructions for use

Please read these instructions carefully and follow them step by step.

You will be trained by your doctor or nurse on how to self-inject ORENCIA using the pre-filled syringe.

Don't try to self-inject until you are sure that you understand how to prepare and give the injection. After proper training, you can give the injection to yourself, or it can be given by another person, for example a family member or friend.

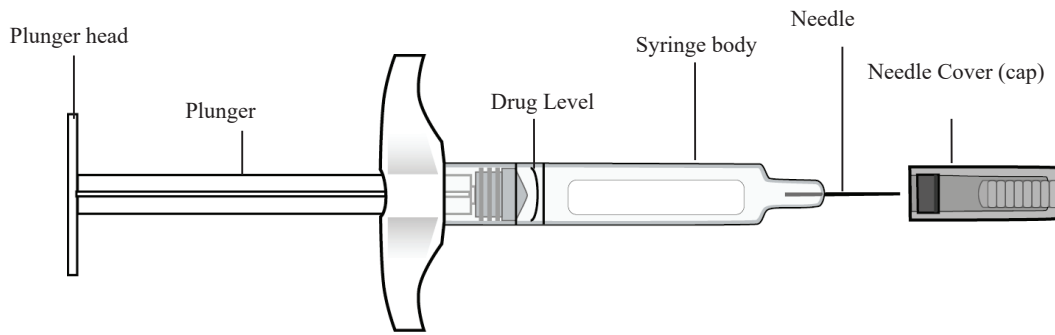

Figure 1

Before you start - some Do's and Don'ts

Do

- ✓ Always handle the ORENCIA syringe carefully, especially when you are around other people, and children.
- ✓ Always hold the syringe by its body.
- ✓ Store unused syringes in the refrigerator in the original carton.
- ✓ Have your additional injection supplies ready before you inject.
 - ☑ **Supplies checklist:** alcohol swabs, cotton ball or gauze, adhesive plaster, Sharps container.Sharps containers are special puncture-resistant disposal bins that can be bought at many retail outlets.

Don't

- ✗ **Don't** remove the needle cover (cap) until you are ready to inject.
- ✗ **Don't** pull back on the plunger at any time.
- ✗ **Don't** shake the syringe, as this may damage the ORENCIA medicine.
- ✗ **DON'T** recap the needle.

STEP 1: Get the syringe ready

A. Check the expiry date and batch number on the carton

- The expiry date can be found on the ORENCIA carton and on each syringe.
- If the expiry date has passed, do not use the syringes. Contact your doctor or pharmacist for assistance.

B. Let the syringe warm up

- Find a comfortable space with a clean, flat, working surface.
- Remove the syringe from the refrigerator. Keep any remaining unused syringes in their original carton, in the refrigerator.
- Check that the expiry date and batch number match the ones on the carton.
- Inspect the syringe for obvious flaws, but **don't** remove the needle cover.

- Allow the syringe to rest at room temperature for 30 to 60 minutes before you inject.
- ✗ **Don't** speed the warming process in any way, such as using the microwave or placing the syringe in warm water.

C. Check the liquid in the syringe

- Hold the syringe by its body, with the covered needle pointing down.

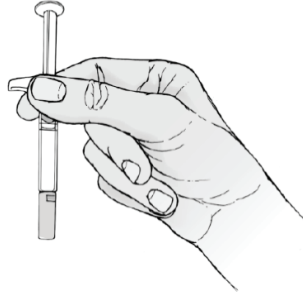

Figure 2

- Look at the liquid in the syringe (Figure 2). The liquid should be clear to pale yellow.
- ✗ **Don't** inject if the liquid is cloudy or discoloured, or has visible particles.
- It is normal to see an air bubble, and there is no reason to remove it. All contents of the syringe should be injected.

D. Gather your additional supplies and keep them within easy reach.

E. Wash your hands thoroughly with soap and warm water.

STEP 2: Choose and prepare your injection site

Have the syringe ready for use immediately after you have prepared your injection site.

A. Choose an area of your body for the injection (injection site)

- You can use:
 - the front of your thigh
 - your abdomen, except for the 5 cm area around the navel (Figure 3).

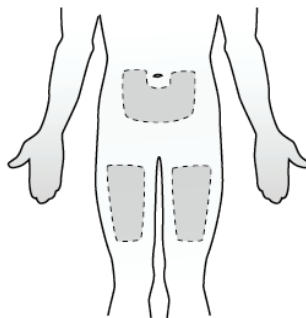

Figure 3

- Choose a different injection site for each new injection. You may use the same thigh for weekly injections, as long as each injection site is approximately 2.5 cm away from where you last injected.
- ✗ **Don't** inject into areas where your skin is tender, bruised, red, scaly, or hard. Avoid any areas with scars or stretch marks.

B. Prepare your injection site

- Wipe your injection site with an alcohol swab in a circular motion.
- Let your skin dry before injecting.
 - × **Don't** touch your injection site again before giving the injection.
 - × **Don't** fan or blow on the clean area.

STEP 3: Inject ORENCIA

A. Remove the needle cover (cap) only when you are ready to administer the injection.

- Hold the syringe by its body in one hand, and pull the needle cover straight off with your other hand (Figure 4).

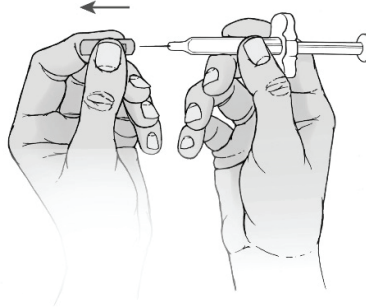

Figure 4

There may be a small air bubble in the liquid in the syringe. There is no need to remove the air bubble.

You may notice a drop of fluid leaving the needle. This is normal and will not affect your dose.

- × **Don't** touch the plunger while you remove the needle cover.
- × **Don't** remove the needle cover until you are ready to inject ORENCIA.
- × **Don't** touch the needle or let it touch any surfaces.
- × **Don't** use the syringe if it is dropped without the needle cover in place.
- × **Don't** put the needle cover back on the needle once removed.
- × **Don't** use the syringe if there are visible signs of needle damage or bending.

B. Position the syringe and inject ORENCIA

- Hold the syringe by its body in one hand between your thumb and index finger (Figure 5).
 - × **Don't** press on the plunger head until you begin your injection.
 - × **Don't** pull back on the plunger at any time.
- Using your other hand, gently pinch the area of skin you cleaned. Hold it firmly.
- Insert the needle with a quick motion into the pinched skin at a 45° angle (Figure 5).

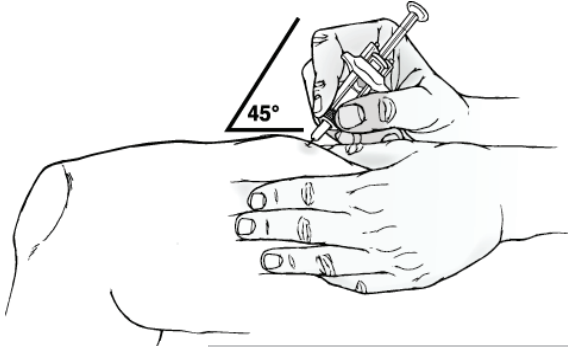

Figure 5

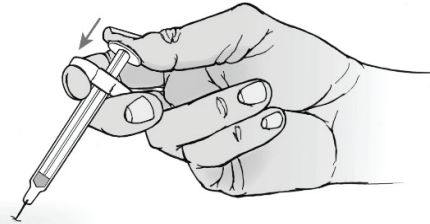

Figure 6

- Use your thumb to push the plunger down, pressing firmly until the plunger will go no further, and all of the medicine has been injected (Figure 6).
- Remove the needle from the skin and let go of the surrounding skin.
 - × **DON'T** recap the needle.
- Press a cotton ball over the injection site and hold for 10 seconds.
 - × **Don't** rub the injection site. Slight bleeding is normal.
- If needed, you may apply a small adhesive plaster to the injection site.

STEP 4: Dispose of the syringe and keep a record

A. Dispose of the used syringe in a Sharps container.

- Ask your doctor, nurse, or pharmacist about national and local laws regarding the proper disposal of medical products that contain needles.
- ✓ **Always** keep your Sharps container out of reach of children and animals.
- × **Don't** throw away used syringes in your household rubbish or recycling bins.

B. Keep a record of your injection

- Write down the date, time, and specific part of your body where you injected yourself. It may also be helpful to write down any questions or concerns about the injection so you can ask your doctor, nurse or pharmacist.

Medicines should not be disposed of via wastewater or household waste. Ask your pharmacist how to dispose of medicines no longer required. These measures will help to protect the environment.

Package leaflet: Information for the patient
ORENCIA 125 mg solution for injection in pre-filled pen
abatacept

Read all of this leaflet carefully before you start using this medicine because it contains important information for you.

- Keep this leaflet. You may need to read it again.
- If you have any further questions, ask your doctor, pharmacist or nurse.
- This medicine has been prescribed for you only. Do not pass it on to others. It may harm them, even if their signs of illness are the same as yours.
- If you get any side effects, talk to your doctor, pharmacist or nurse. This includes any possible side effects not listed in this leaflet. See section 4.

What is in this leaflet

1. What ORENCIA is and what it is used for
2. What you need to know before you use ORENCIA
3. How to use ORENCIA
4. Possible side effects
5. How to store ORENCIA
6. Contents of the pack and other information

1. What ORENCIA is and what it is used for

ORENCIA contains the active substance abatacept, a protein produced in cell cultures. ORENCIA lessens the immune system's attack on normal tissues by interfering with the immune cells (called T lymphocytes) that contribute to the development of rheumatoid arthritis. ORENCIA selectively modulates the activation of T cells involved in the immune system's inflammatory response.

ORENCIA is used to treat rheumatoid arthritis and psoriatic arthritis in adults.

Rheumatoid Arthritis

Rheumatoid arthritis is a long-term progressive systemic disease that, if untreated, can lead to serious consequences, such as joint destruction, increased disability and impairment of daily activities. In people with rheumatoid arthritis the body's own immune system attacks normal body tissues, leading to pain and swelling of the joints. This can cause joint damage. Rheumatoid arthritis (RA) affects everyone differently. In most people, joint symptoms develop gradually over several years. However, in some, RA may progress rapidly and yet other people may have RA for a limited period of time and then enter a period of remission. RA is usually a chronic (long-term), progressive disease. This means, even if you're on treatment, whether or not you're still having symptoms, RA could be continuing to damage your joints. By finding the right treatment plan for you, you may be able to slow down this disease process, which may help reduce long-term joint damage, as well as pain and fatigue and improve your overall quality of life.

ORENCIA is used to treat moderate to severe active rheumatoid arthritis when you do not respond well enough to treatment with other disease-modifying medicines or with another group of medicines called 'tumour necrosis factor (TNF) blockers'. It is used in combination with a medicine called methotrexate.

ORENCIA can also be used with methotrexate to treat highly active and progressive rheumatoid arthritis without previous methotrexate treatment.

ORENCIA is used to:

- slow down the damage to your joints
- improve your physical function

Psoriatic Arthritis

Psoriatic arthritis is an inflammatory disease of the joints, usually accompanied by psoriasis, an inflammatory disease of the skin. If you have active psoriatic arthritis you will first be given other medicines. If you do not respond well enough to these medicines, you may be given ORENCIA to:

- Reduce the signs and symptoms of your disease.
- Slow down the damage to your bones and joints.
- Improve your physical function and your ability to do normal daily activities.

ORENCIA is used to treat psoriatic arthritis alone or in combination with methotrexate

2. What you need to know before you use ORENCIA

Do not use ORENCIA

- **if you are allergic** to abatacept or any of the other ingredients of this medicine (listed in section 6).
- **if you have a severe or uncontrolled infection**, do not start treatment with ORENCIA. Having an infection could put you at risk of serious side effects from ORENCIA.

Warnings and precautions

Talk to your doctor, pharmacist or nurse:

- **if you experience allergic reactions** such as chest tightness, wheezing, severe dizziness or lightheadedness, swelling or skin rash **tell your doctor immediately**.
- if you, your partner or your caregiver notice **new onset or worsening of neurological symptoms** including general muscle weakness, disturbance of vision, difficulty speaking, a **change in the way you walk** or problem with your **balance, changes in thinking, memory and orientation** leading to confusion and personality changes **contact your doctor immediately** because these may be symptoms of a very rare, serious and potentially fatal brain infection called progressive multifocal leukoencephalopathy (PML).
- **if you have any kind of infection**, including long-term or localised infection, if you often get infections or **if you have symptoms of infection (e.g. fever, malaise, dental problems), it is important to tell your doctor**. ORENCIA can lower your body's ability to fight infection and the treatment can make you more likely to get infections or make any infection you have worse.
- **if you have had tuberculosis (TB)** or have symptoms of tuberculosis (persistent cough, weight loss, listlessness, mild fever) **tell your doctor**. Before you use ORENCIA, your doctor will examine you for tuberculosis or do a skin test.
- **if you have viral hepatitis** tell your doctor. Before you use ORENCIA, your doctor may examine you for hepatitis.
- **if you have cancer**, your doctor will decide if you can still be given ORENCIA.
- **if you recently had a vaccination** or are planning to have one, **tell your doctor**. Some vaccines should not be given while you are receiving ORENCIA. **Check with your doctor before you are given any vaccines**. Certain vaccinations may cause infections from the vaccine. If you received ORENCIA while you were pregnant, your baby may be at a higher risk for getting such an infection for up to approximately 14 weeks after the last dose you received during pregnancy. It is important that you tell your baby's doctors and other health care professionals about your ORENCIA use during your pregnancy so they can decide when your baby should receive any vaccine.

Your doctor may also do tests to examine your blood values.

Children and adolescents

ORENCIA solution for injection in pre-filled pen has not been studied in children and adolescents under the age of 18 years. Therefore, ORENCIA solution for injection in pre-filled pen is not recommended for use in this patient population.

ORENCIA powder for concentrate for solution for infusion is available for paediatric patients 6 years of age and older.

ORENCIA solution for injection pre-filled syringe is available for paediatric patients 2 years of age and older.

Other medicines and ORENCIA

Tell your doctor if you are taking, have recently taken or might take any other medicines.

ORENCIA should not be used with biological medicines for rheumatoid arthritis, including TNF-blockers like adalimumab, etanercept, and infliximab; there is not enough evidence to recommend its being given with anakinra and rituximab.

ORENCIA can be used with other medicines commonly used to treat rheumatoid arthritis, such as steroids or painkillers, including non-steroidal anti-inflammatories such as ibuprofen or diclofenac.

Ask your doctor or pharmacist for advice before taking any other medicine while using ORENCIA.

Pregnancy and breast-feeding

The effects of ORENCIA in pregnancy are not known, so do not use ORENCIA if you are pregnant unless your doctor specifically recommends it.

- if you are a woman who could become pregnant, you must use reliable contraception (birth control) while using ORENCIA and up to 14 weeks after the last dose. Your doctor will advise you on suitable methods.
- if you become pregnant while using ORENCIA, tell your doctor.

If you received ORENCIA during your pregnancy, your baby may have a higher risk for getting an infection. It is important that you tell your baby's doctors and other health care professionals about your ORENCIA use during your pregnancy before the baby receives any vaccine (for more information see section on vaccination).

It is not known whether ORENCIA passes into human milk. **You must stop breast-feeding** if you are being treated with ORENCIA and for up to 14 weeks after the last dose.

Driving and using machines

The use of ORENCIA is not expected to affect the ability to drive or use machines. However, if you are feeling tired or unwell after receiving ORENCIA, you should not drive or operate any machinery.

ORENCIA contains sodium

This medicine contains less than 1 mmol sodium (23 mg) per dose, that is to say essentially 'sodium-free'.

3. How to use ORENCIA

Always use this medicine exactly as your doctor or pharmacist has told you. Check with your doctor or pharmacist if you are not sure.

ORENCIA solution for injection is injected under the skin (subcutaneous use).

Recommended dose

The recommended dose of ORENCIA for adults with rheumatoid arthritis or psoriatic arthritis is 125 mg abatacept given every week regardless of weight.

Your doctor may start your ORENCIA treatment with or without a one-time dose of powder for concentrate for solution for infusion (given to you into a vein, usually in your arm, over a period of 30 minutes). If a single intravenous dose is given to start the treatment, the first subcutaneous injection of ORENCIA should be given within a day of the intravenous infusion, followed by the weekly 125 mg subcutaneous injections.

ORENCIA can be used by adults over 65 with no change in dose.

If you are already on intravenous ORENCIA treatment and wish to transition to ORENCIA subcutaneous, you should receive a subcutaneous injection instead of your next intravenous infusion, followed by weekly subcutaneous injections of ORENCIA.

Your doctor will advise you on the duration of treatment and what other medicines, including other disease-modifying medicines, if any, you may continue to take while on ORENCIA.

At the start, your doctor or nurse may inject ORENCIA. However, you and your doctor may decide that you can inject ORENCIA yourself. In this case, you will get training on how to inject ORENCIA yourself.

Talk to your doctor if you have any questions about giving yourself an injection. You will find detailed instructions for the preparation and administration of ORENCIA at the end of this leaflet (see "**Important instructions for use**").

If you use more ORENCIA than you should

If this happens, contact immediately your doctor who will monitor you for any signs or symptoms of side effects, and treat these symptoms if necessary.

If you forget to use ORENCIA

Keep track of your next dose. It is very important to use ORENCIA exactly as prescribed by your doctor. If you miss your dose within three days of when you are supposed to take it, take your dose as soon as you remember and then follow your original dosing schedule on your chosen day. If you miss your dose by more than three days, ask your doctor when to take your next dose.

If you stop using ORENCIA

The decision to stop using ORENCIA should be discussed with your doctor.

If you have any further questions on the use of this medicine, **ask your doctor, pharmacist or nurse.**

4. Possible side effects

Like all medicines, this medicine can cause side effects, although not everybody gets them. The most common side effects with ORENCIA are infections of the upper airway (including infections of the nose and throat), headache and nausea, as listed below. ORENCIA can cause serious side effects, which may need treatment.

Possible serious side effects include serious infections, malignancies (cancer) and allergic reactions, as listed below.

Tell your doctor immediately if you notice any of the following:

- severe rash, hives or other signs of allergic reaction
- swollen face, hands or feet

- trouble breathing or swallowing
- fever, persistent cough, weight loss, listlessness

Tell your doctor as soon as possible if you notice any of the following:

- feeling generally unwell, dental problems, burning sensation during urination, painful skin rash, painful skin blisters, coughing

The symptoms described above can be signs of the side effects listed below, all of which have been observed with ORENCIA in adult clinical trials:

List of side effects:

Very common (may affect more than 1 in 10 people):

- infections of the upper airway (including infections of the nose, throat and sinuses).

Common (may affect up to 1 in 10 people):

- infections of lungs, urinary infections, painful skin blisters (herpes), flu
- headache, dizziness
- high blood pressure
- cough
- abdominal pain, diarrhoea, nausea, upset stomach, mouth sores, vomiting
- rash
- fatigue, weakness, injection site reactions
- abnormal liver function tests.

Uncommon (may affect up to 1 in 100 people):

- tooth infection, nail fungal infection, infection in the muscles, blood stream infection, collection of pus under the skin, kidney infection, ear infection
- low white blood cells count
- skin cancer, skin warts
- low blood platelet count
- allergic reactions
- depression, anxiety, sleep disturbance
- migraine
- numbness
- dry eye, reduced vision
- eye inflammation
- palpitation, rapid heart rate, low heart rate
- low blood pressure, hot flush, blood vessels inflammation, flushing
- difficulty in breathing, wheezing, shortness of breath, acute worsening of a lung disease called chronic obstructive pulmonary disease (COPD)
- throat tightness
- rhinitis
- increased tendency to bruise, dry skin, psoriasis, skin redness, excessive sweating, acne
- hair loss, itching, hives
- painful joints
- pain in the extremities
- absence of menstruation, excessive menses
- flu-like illness, increased weight

Rare (may affect up to 1 in 1,000 people):

- tuberculosis
- inflammation of uterus, fallopian tubes and/or ovaries
- gastrointestinal infection
- cancer of white blood cells, lung cancer

Reporting of side effects

If you get any side effects, talk to your doctor, pharmacist or nurse. This includes any possible side effects not listed in this leaflet. You can also report side effects directly via [the national reporting system listed in Appendix V](#). By reporting side effects you can help provide more information on the safety of this medicine.

5. How to store ORENCIA

Keep this medicine out of the sight and reach of children.

Do not use this medicine after the expiry date which is stated on the label and the carton after EXP. The expiry date refers to the last day of that month.

Store in a refrigerator (2°C to 8°C). Do not freeze.

Store in the original package in order to protect from light.

Do not use this medicine if the liquid is cloudy or discoloured, or has large particles. The liquid should be clear to pale yellow.

Do not throw away any medicines via wastewater or household waste. Ask your pharmacist how to throw away medicines you no longer use. These measures will help to protect the environment.

6. Contents of the pack and other information

What ORENCIA contains

- The active substance is abatacept.
- Each pre-filled pen contains 125 mg of abatacept in one mL.
- The other ingredients are sucrose, poloxamer 188, sodium dihydrogen phosphate monohydrate, disodium phosphate anhydrous, and water for injections (see section 2 "ORENCIA contains sodium").

What ORENCIA looks like and contents of the pack

ORENCIA solution for injection (injection) is a clear, colourless to pale yellow solution provided in a pre-filled pen called ClickJect.

ORENCIA is available in the following presentations:

- pack of 4 pre-filled pens and multipack containing 12 pre-filled pens (3 packs of 4).

Not all pack sizes may be marketed.

Marketing Authorisation Holder

Bristol-Myers Squibb Pharma EEIG
Plaza 254
Blanchardstown Corporate Park 2
Dublin 15, D15 T867
Ireland

Manufacturer

CATALENT ANAGNI S.R.L.
Loc. Fontana del Ceraso snc
Strada Provinciale 12 Casilina, 41
03012 Anagni (FR)
Italy

Swords Laboratories Unlimited Company t/a Bristol-Myers Squibb Cruiserath Biologics
Cruiserath Road, Mulhuddart
Dublin 15
Ireland

This leaflet was last revised in

Other sources of information

Detailed information on this medicine is available on the European Medicines Agency web site:
<http://www.ema.europa.eu>.

Important instructions for use. Read carefully.

HOW TO USE

ORENCIA (abatacept)
ClickJect Pre-filled Pen
125 mg, solution for injection
subcutaneous use

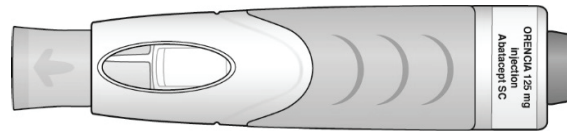

Read these instructions before you use the ClickJect Pre-filled Pen.

Before you use the ClickJect Pen for the first time, make sure your healthcare provider shows you the right way to use it.

Keep the pen refrigerated until ready to use. **DO NOT FREEZE.**

If you have questions about this product, please read the Package Leaflet.

BEFORE YOU BEGIN

Get to know the ClickJect Pre-filled Pen

- The Pen automatically delivers the medicine. The transparent tip locks over the needle once the injection is complete and the Pen is removed from the skin.
- **DO NOT remove the orange needle cover until you are ready to inject.**

Before Use

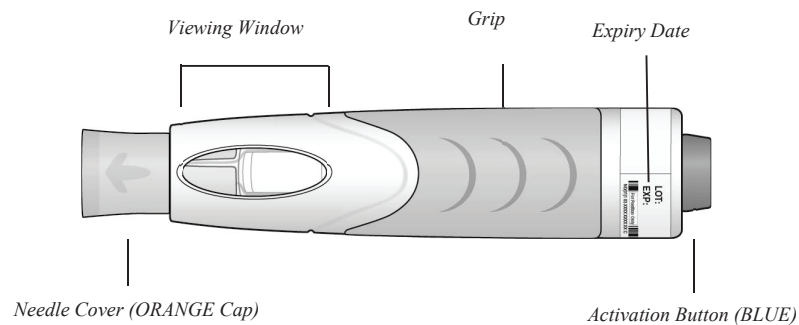

After Use

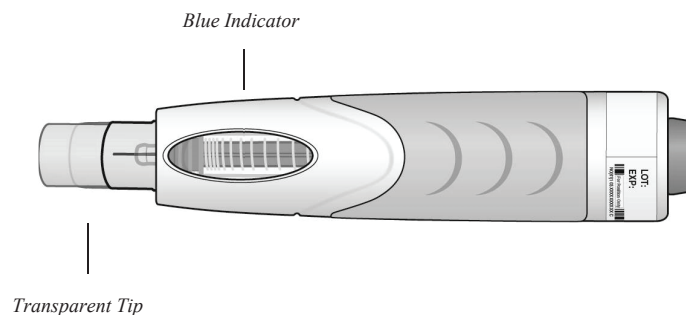

Gather supplies for your injection on a clean, flat surface
(only the ClickJect Pre-filled Pen is included in the package):

- Alcohol swab
- Adhesive plaster
- Cotton ball or gauze

- ClickJect Pre-filled Pen
- Sharps disposal container

Proceed to Step 1

1. PREPARE YOUR CLICKJECT PEN

Let your ClickJect Pen warm up.

Remove one Pen from the refrigerator and let it rest at room temperature (about 25°C) for **30 minutes**.

DO NOT remove the needle cover from the Pen while allowing it to reach room temperature.

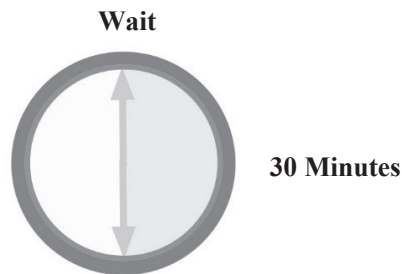

Wash your hands well with soap and water to prepare for injection.

Examine the ClickJect Pre-filled Pen:

- **Check the expiry date** printed on the label.
DO NOT use if past the expiry date.
- **Check the Pen for damage.**
DO NOT use if it is cracked or broken.
- **Check the liquid** through the viewing window. It should be clear to pale yellow. You may see a small air bubble. You do not need to remove it.
DO NOT inject if the liquid is cloudy, discoloured or has visible particles.

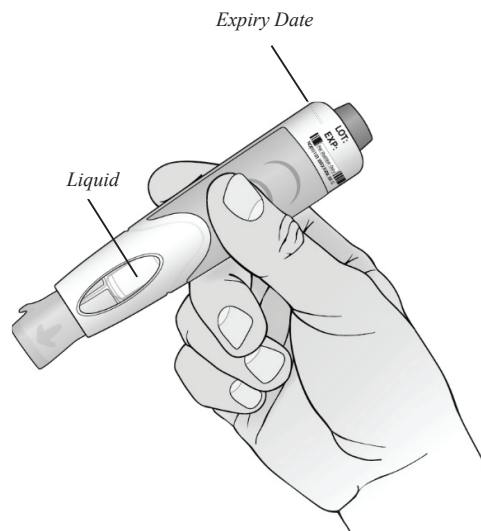

Proceed to Step 2

2. PREPARE FOR INJECTION

Choose your injection site in either the **abdomen** or front of the **thigh**.

Each week you can use the same area of your body, but use a different injection site in that area.

DO NOT inject into an area where the skin is tender, bruised, red, scaly, or hard. Avoid any areas with scars or stretch marks.

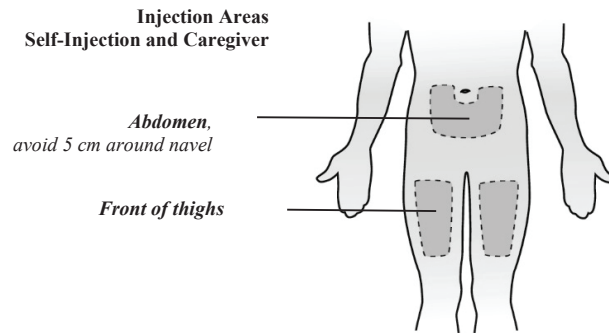

Gently clean injection site with an alcohol swab and let your skin dry.

Pull orange needle cover STRAIGHT off

- **DO NOT** twist the needle cover
- **DO NOT** replace the cap on the Pen.
You can discard the cap in your household waste after the injection.
- **DO NOT** use the Pen if it is dropped after the cap is removed.
It's normal to see a drop of fluid leaving the needle.

Pull Needle Cover Straight Off

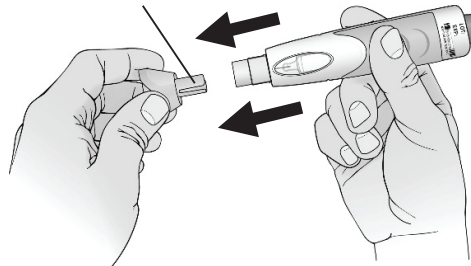

Proceed to Step 3

3. INJECT YOUR DOSE

Position the ClickJect Pen so you can see the **viewing window** and it's at a 90° angle to the injection site. With your other hand, gently **pinch the cleaned skin**.

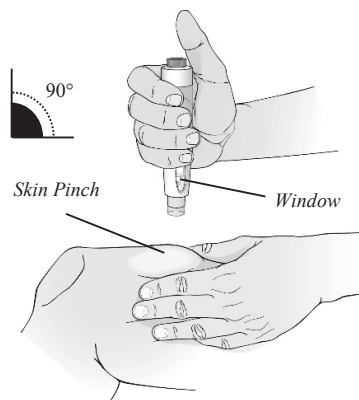

Complete ALL steps for full-dose delivery:

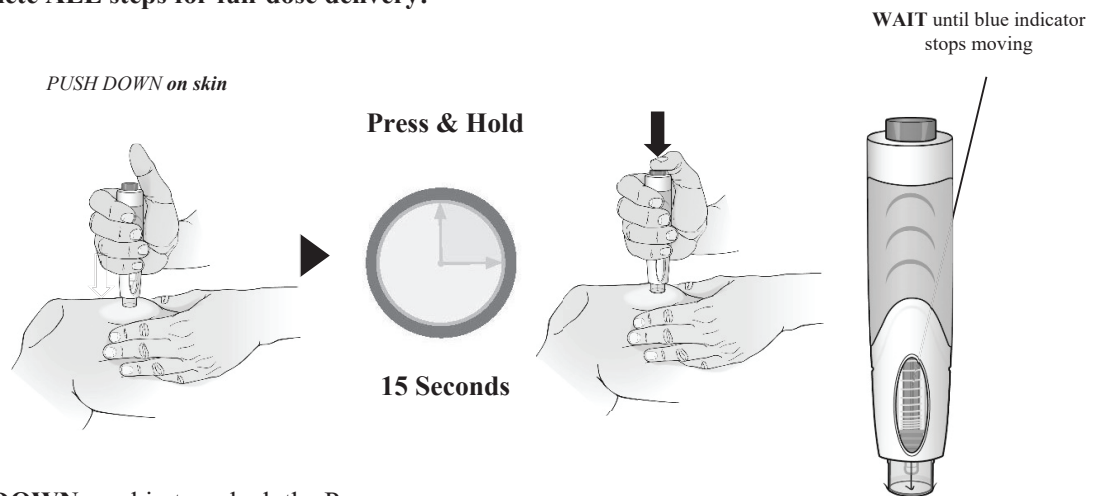

Push DOWN on skin to unlock the Pen.

Press button, HOLD for 15 seconds AND watch window.

- You will hear a click as the injection begins.
- For full-dose delivery, hold the Pre-filled Pen in place for 15 seconds AND wait until blue indicator stops moving in window.

Remove the ClickJect Pre-filled Pen from the injection site by lifting it straight up. Once you remove it from your skin, the transparent tip will lock over the needle. Release skin pinch.

Proceed to Step 4

4. AFTER THE INJECTION

Care of injection site:

- There may be a little bleeding at the injection site. You can press a cotton ball or gauze over the injection site.
- **DO NOT** rub the injection site.
- If needed, you may cover the injection site with a small adhesive plaster.

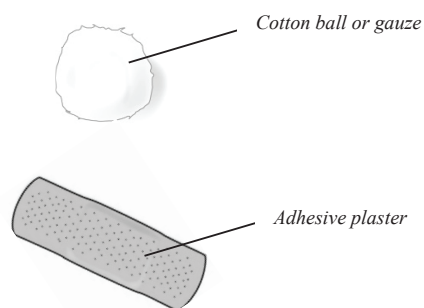

Dispose of used ClickJect Pre-filled Pen into sharps disposal container right away after use. Should you have any questions, ask your pharmacist.

- **DO NOT** replace the cap on the used Pen.

See Package Leaflet for additional disposal information.

If your injection is administered by a caregiver, this person must also handle the Pen carefully to prevent accidental needle stick injury and possibly spreading infection.

Keep Pen and the disposal container out of the reach of children.

Record the date, time and site where you injected.