

ANNEX I
SUMMARY OF PRODUCT CHARACTERISTICS

1. NAME OF THE MEDICINAL PRODUCT

Prolia 60 mg solution for injection in pre-filled syringe

2. QUALITATIVE AND QUANTITATIVE COMPOSITION

Each pre-filled syringe contains 60 mg of denosumab in 1 mL of solution (60 mg/mL).

Denosumab is a human monoclonal IgG2 antibody produced in a mammalian cell line (Chinese hamster ovary cells) by recombinant DNA technology.

Excipient with known effect

This medicine contains 47 mg sorbitol in each mL of solution..

For the full list of excipients, see section 6.1.

3. PHARMACEUTICAL FORM

Solution for injection (injection).

Clear, colourless to slightly yellow solution.

4. CLINICAL PARTICULARS

4.1 Therapeutic indications

Treatment of osteoporosis in postmenopausal women and in men at increased risk of fractures. In postmenopausal women Prolia significantly reduces the risk of vertebral, non-vertebral and hip fractures.

Treatment of bone loss associated with hormone ablation in men with prostate cancer at increased risk of fractures (see section 5.1). In men with prostate cancer receiving hormone ablation, Prolia significantly reduces the risk of vertebral fractures.

Treatment of bone loss associated with long-term systemic glucocorticoid therapy in adult patients at increased risk of fracture (see section 5.1).

4.2 Posology and method of administration

Posology

The recommended dose of Prolia is 60 mg administered as a single subcutaneous injection once every 6 months into the thigh, abdomen or upper arm.

Patients must be adequately supplemented with calcium and vitamin D (see section 4.4).

Patients treated with Prolia should be given the package leaflet and the patient reminder card.

The optimal total duration of antiresorptive treatment for osteoporosis (including both denosumab and bisphosphonates) has not been established. The need for continued treatment should be re-evaluated periodically based on the benefits and potential risks of denosumab on an individual patient basis, particularly after 5 or more years of use (see section 4.4).

Renal impairment

No dose adjustment is required in patients with renal impairment (see section 4.4 for recommendations relating to monitoring of calcium).

No data is available in patients with long-term systemic glucocorticoid therapy and severe renal impairment (GFR < 30 ml/min).

Hepatic impairment

The safety and efficacy of denosumab have not been studied in patients with hepatic impairment (see section 5.2).

Elderly (age ≥ 65)

No dose adjustment is required in elderly patients.

Paediatric population

Prolia is not recommended in paediatric patients (age < 18) as the safety and efficacy of Prolia in these patients have not been established. Inhibition of RANK/RANK ligand (RANKL) in animal studies has been coupled to inhibition of bone growth and lack of tooth eruption (see section 5.3).

Method of administration

For subcutaneous use.

Administration should be performed by an individual who has been adequately trained in injection techniques.

The instructions for use, handling and disposal are given in section 6.6.

4.3 Contraindications

Hypersensitivity to the active substance or to any of the excipients listed in section 6.1.

Hypocalcaemia (see section 4.4).

4.4 Special warnings and precautions for use

Calcium and Vitamin D supplementation

Adequate intake of calcium and vitamin D is important in all patients.

Precautions for use

Hypocalcaemia

It is important to identify patients at risk for hypocalcaemia. Hypocalcaemia must be corrected by adequate intake of calcium and vitamin D before initiating therapy. Clinical monitoring of calcium levels is recommended before each dose and, in patients predisposed to hypocalcaemia within two weeks after the initial dose. If any patient presents with suspected symptoms of hypocalcaemia during treatment (see section 4.8 for symptoms) calcium levels should be measured. Patients should be encouraged to report symptoms indicative of hypocalcaemia.

In the post-marketing setting, severe symptomatic hypocalcaemia has been reported (see section 4.8), with most cases occurring in the first weeks of initiating therapy, but it can occur later.

Concomitant glucocorticoid treatment is an additional risk factor for hypocalcaemia.

Renal impairment

Patients with severe renal impairment (creatinine clearance < 30 mL/min) or receiving dialysis are at greater risk of developing hypocalcaemia. The risks of developing hypocalcaemia and accompanying parathyroid hormone elevations increase with increasing degree of renal impairment. Adequate intake of calcium, vitamin D and regular monitoring of calcium is especially important in these patients, see above.

Skin infections

Patients receiving Prolia may develop skin infections (predominantly cellulitis) leading to hospitalisation (see section 4.8). Patients should be advised to seek prompt medical attention if they develop signs or symptoms of cellulitis.

Osteonecrosis of the Jaw (ONJ)

ONJ has been reported rarely in patients receiving Prolia for osteoporosis (see section 4.8).

The start of treatment/new treatment course should be delayed in patients with unhealed open soft tissue lesions in the mouth. A dental examination with preventive dentistry and an individual benefit-risk assessment is recommended prior to treatment with denosumab in patients with concomitant risk factors.

The following risk factors should be considered when evaluating a patient's risk of developing ONJ:

- potency of the medicinal product that inhibits bone resorption (higher risk for highly potent compounds), route of administration (higher risk for parenteral administration) and cumulative dose of bone resorption therapy.
- cancer, co-morbid conditions (e.g. anaemia, coagulopathies, infection), smoking.
- concomitant therapies: corticosteroids, chemotherapy, angiogenesis inhibitors, radiotherapy to head and neck.
- poor oral hygiene, periodontal disease, poorly fitting dentures, history of dental disease, invasive dental procedures e.g. tooth extractions.

All patients should be encouraged to maintain good oral hygiene, receive routine dental check-ups, and immediately report any oral symptoms such as dental mobility, pain or swelling or non-healing of sores or discharge during treatment with denosumab. While on treatment, invasive dental procedures should be performed only after careful consideration and be avoided in close proximity to Prolia administration.

The management plan of the patients who develop ONJ should be set up in close collaboration between the treating physician and a dentist or oral surgeon with expertise in ONJ. Temporary interruption of treatment should be considered until the condition resolves and contributing risk factors are mitigated where possible.

Osteonecrosis of the external auditory canal

Osteonecrosis of the external auditory canal has been reported with denosumab. Possible risk factors for osteonecrosis of the external auditory canal include steroid use and chemotherapy and/or local risk factors such as infection or trauma. The possibility of osteonecrosis of the external auditory canal should be considered in patients receiving denosumab who present with ear symptoms including chronic ear infections.

Atypical fractures of the femur

Atypical femoral fractures have been reported in patients receiving denosumab (see section 4.8). Atypical femoral fractures may occur with little or no trauma in the subtrochanteric and diaphyseal regions of the femur. Specific radiographic findings characterise these events. Atypical femoral fractures have also been reported in patients with certain co-morbid conditions (e.g. vitamin D deficiency, rheumatoid arthritis, hypophosphatasia) and with use of certain pharmaceutical agents (e.g. bisphosphonates, glucocorticoids, proton pump inhibitors). These events have also occurred without antiresorptive therapy. Similar fractures reported in association with bisphosphonates are often bilateral; therefore the contralateral femur should be examined in denosumab-treated patients who

have sustained a femoral shaft fracture. Discontinuation of Prolia therapy in patients suspected to have an atypical femur fracture should be considered pending evaluation of the patient based on an individual benefit-risk assessment. During denosumab treatment, patients should be advised to report new or unusual thigh, hip, or groin pain. Patients presenting with such symptoms should be evaluated for an incomplete femoral fracture.

Long-term antiresorptive treatment

Long-term antiresorptive treatment (including both denosumab and bisphosphonates) may contribute to an increased risk for adverse outcomes such as osteonecrosis of the jaw and atypical femur fractures due to significant suppression of bone remodelling (see section 4.2).

Concomitant treatment with other denosumab-containing medicinal products

Patients being treated with Prolia should not be treated concomitantly with other denosumab-containing medicinal products (for prevention of skeletal related events in adults with bone metastases from solid tumours).

Dry natural rubber

The needle cover of the pre-filled syringe contains dry natural rubber (a derivative of latex), which may cause allergic reactions.

Warnings for excipients

This medicine contains 47 mg sorbitol in each mL of solution. The additive effect of concomitantly administered products containing sorbitol (or fructose) and dietary intake of sorbitol (or fructose) should be taken into account.

This medicinal product contains less than 1 mmol sodium (23 mg) per 60 mg i.e. essentially 'sodium-free'.

4.5 Interaction with other medicinal products and other forms of interaction

In an interaction study, Prolia did not affect the pharmacokinetics of midazolam, which is metabolised by cytochrome P450 3A4 (CYP3A4). This indicates that Prolia should not alter the pharmacokinetics of medicinal products metabolised by CYP3A4.

There are no clinical data on the co-administration of denosumab and hormone replacement therapy (oestrogen), however the potential for a pharmacodynamic interaction is considered to be low.

In postmenopausal women with osteoporosis the pharmacokinetics and pharmacodynamics of denosumab were not altered by previous alendronate therapy, based on data from a transition study (alendronate to denosumab).

4.6 Fertility, pregnancy and lactation

Pregnancy

There are no or limited amount of data from the use of denosumab in pregnant women. Studies in animals have shown reproductive toxicity (see section 5.3).

Prolia is not recommended for use in pregnant women and women of child-bearing potential not using contraception. Women should be advised not to become pregnant during and for at least 5 months after treatment with Prolia. Any effects of Prolia are likely to be greater during the second and third trimesters of pregnancy since monoclonal antibodies are transported across the placenta in a linear fashion as pregnancy progresses, with the largest amount transferred during the third trimester.

Breast-feeding

It is unknown whether denosumab is excreted in human milk. In genetically engineered mice in which RANKL has been turned off by gene removal (a “knockout mouse”), studies suggest absence of RANKL (the target of denosumab see section 5.1) during pregnancy may interfere with maturation of the mammary gland leading to impaired lactation post-partum (see section 5.3). A decision on whether to abstain from breast-feeding or to abstain from therapy with Prolia should be made, taking into account the benefit of breast-feeding to the newborn/infant and the benefit of Prolia therapy to the woman.

Fertility

No data are available on the effect of denosumab on human fertility. Animal studies do not indicate direct or indirect harmful effects with respect to fertility (see section 5.3).

4.7 Effects on ability to drive and use machines

Prolia has no or negligible influence on the ability to drive and use machines.

4.8 Undesirable effects

Summary of the safety profile

The most common side effects with Prolia (seen in more than one patient in ten) are musculoskeletal pain and pain in the extremity. Uncommon cases of cellulitis, rare cases of hypocalcaemia, hypersensitivity, osteonecrosis of the jaw and atypical femoral fractures (see section 4.4 and section 4.8 - description of selected adverse reactions) have been observed in patients taking Prolia.

Tabulated list of adverse reactions

The data in Table 1 below describe adverse reactions reported from Phase II and III clinical trials in patients with osteoporosis and breast or prostate cancer patients receiving hormone ablation; and/or spontaneous reporting.

The following convention has been used for the classification of the adverse reactions (see table 1): very common ($\geq 1/10$), common ($\geq 1/100$ to $< 1/10$), uncommon ($\geq 1/1,000$ to $< 1/100$), rare ($\geq 1/10,000$ to $< 1/1,000$) and very rare ($< 1/10,000$). Within each frequency grouping and system organ class, adverse reactions are presented in order of decreasing seriousness.

Table 1. Adverse reactions reported in patients with osteoporosis and breast or prostate cancer patients receiving hormone ablation

MedDRA system organ class	Frequency category	Adverse reactions
Infections and infestations	Common	Urinary tract infection
	Common	Upper respiratory tract infection
	Uncommon	Diverticulitis ¹
	Uncommon	Cellulitis ¹
	Uncommon	Ear infection
Immune system disorders	Rare	Drug hypersensitivity ¹
	Rare	Anaphylactic reaction ¹
Metabolism and nutrition disorders	Rare	Hypocalcaemia ¹
Nervous system disorders	Common	Sciatica
Gastrointestinal disorders	Common	Constipation
	Common	Abdominal discomfort

MedDRA system organ class	Frequency category	Adverse reactions
Skin and subcutaneous tissue disorders	Common Common	Rash Eczema
Musculoskeletal and connective tissue disorders	Very common Very common Rare Rare Not Known	Pain in extremity Musculoskeletal pain ¹ Osteonecrosis of the jaw ¹ Atypical femoral fractures ¹ Osteonecrosis of the external auditory canal ²

¹ See section Description of selected adverse reactions

² See section 4.4

In a pooled analysis of data from all phase II and phase III placebo-controlled studies, Influenza-like illness was reported with a crude incidence rate of 1.2% for denosumab and 0.7% for placebo. Although this imbalance was identified via a pooled analysis, it was not identified via a stratified analysis.

Description of selected adverse reactions

Hypocalcaemia

In two phase III placebo-controlled clinical trials in postmenopausal women with osteoporosis, approximately 0.05% (2 out of 4,050) of patients had declines of serum calcium levels (less than 1.88 mmol/l) following Prolia administration. Declines of serum calcium levels (less than 1.88 mmol/l) were not reported in either the two phase III placebo-controlled clinical trials in patients receiving hormone ablation or the phase III placebo-controlled clinical trial in men with osteoporosis.

In the post-marketing setting, rare cases of severe symptomatic hypocalcaemia have been reported predominantly in patients at increased risk of hypocalcaemia receiving Prolia, with most cases occurring in the first weeks of initiating therapy. Examples of the clinical manifestations of severe symptomatic hypocalcaemia have included QT interval prolongation, tetany, seizures and altered mental status (see section 4.4). Symptoms of hypocalcaemia in denosumab clinical studies included paraesthesias or muscle stiffness, twitching, spasms and muscle cramps.

Skin infections

In phase III placebo-controlled clinical trials, the overall incidence of skin infections was similar in the placebo and the Prolia groups: in postmenopausal women with osteoporosis (placebo [1.2%, 50 out of 4,041] versus Prolia [1.5%, 59 out of 4,050]); in men with osteoporosis (placebo [0.8%, 1 out of 120] versus Prolia [0%, 0 out of 120]); in breast or prostate cancer patients receiving hormone ablation (placebo [1.7%, 14 out of 845] versus Prolia [1.4%, 12 out of 860]). Skin infections leading to hospitalisation were reported in 0.1% (3 out of 4,041) of postmenopausal women with osteoporosis receiving placebo versus 0.4% (16 out of 4,050) of women receiving Prolia. These cases were predominantly cellulitis. Skin infections reported as serious adverse reactions were similar in the placebo (0.6%, 5 out of 845) and the Prolia (0.6%, 5 out of 860) groups in the breast and prostate cancer studies.

Osteonecrosis of the jaw

ONJ has been reported rarely, in 16 patients, in clinical trials in osteoporosis and in breast or prostate cancer patients receiving hormone ablation including a total of 23,148 patients (see section 4.4). Thirteen of these ONJ cases occurred in postmenopausal women with osteoporosis during the phase III clinical trial extension following treatment with Prolia for up to 10 years. Incidence of ONJ was 0.04% at 3 years, 0.06% at 5 years and 0.44% at 10 years of Prolia treatment. The risk of ONJ increased with duration of exposure to Prolia.

Atypical fractures of the femur

In the osteoporosis clinical trial program, atypical femoral fractures were reported rarely in patients treated with Prolia (see section 4.4).

Diverticulitis

In a single phase III placebo-controlled clinical trial in patients with prostate cancer receiving ADT an imbalance in diverticulitis adverse events was observed (1.2% denosumab, 0% placebo). The incidence of diverticulitis was comparable between treatment groups in postmenopausal women or men with osteoporosis and in women undergoing aromatase inhibitor therapy for non-metastatic breast cancer.

Drug-related hypersensitivity reactions

In the post-marketing setting, rare events of drug-related hypersensitivity, including rash, urticaria, facial swelling, erythema, and anaphylactic reactions have been reported in patients receiving Prolia.

Musculoskeletal pain

Musculoskeletal pain, including severe cases, has been reported in patients receiving Prolia in the post-marketing setting. In clinical trials, musculoskeletal pain was very common in both denosumab and placebo groups. Musculoskeletal pain leading to discontinuation of study treatment was uncommon.

Other special populations

Renal impairment

In clinical studies, patients with severe renal impairment (creatinine clearance < 30 mL/min) or receiving dialysis were at greater risk of developing hypocalcaemia in the absence of calcium supplementation. Adequate intake of calcium and vitamin D is important in patients with severe renal impairment or receiving dialysis (see section 4.4).

Reporting of suspected adverse reactions

Reporting suspected adverse reactions after authorisation of the medicinal product is important. It allows continued monitoring of the benefit-risk balance of the medicinal product. Healthcare professionals are asked to report any suspected adverse reactions via the national reporting system listed in [Appendix V](#).

4.9 Overdose

There is no experience with overdose in clinical studies. Denosumab has been administered in clinical studies using doses up to 180 mg every 4 weeks (cumulative doses up to 1,080 mg over 6 months), and no additional adverse reactions were observed.

5. PHARMACOLOGICAL PROPERTIES

5.1 Pharmacodynamic properties

Pharmacotherapeutic group: Drugs for the treatment of bone diseases – Other drugs affecting bone structure and mineralisation, ATC code: M05BX04

Mechanism of action

Denosumab is a human monoclonal antibody (IgG2) that targets and binds with high affinity and specificity to RANKL, preventing activation of its receptor, RANK, on the surface of osteoclast precursors and osteoclasts. Prevention of the RANKL/RANK interaction inhibits osteoclast formation, function and survival, thereby decreasing bone resorption in cortical and trabecular bone.

Pharmacodynamic effects

Prolia treatment rapidly reduced the rate of bone turnover, reaching a nadir for the bone resorption marker serum type 1 C-telopeptides (CTX) (85% reduction) by 3 days, with reductions maintained

over the dosing interval. At the end of each dosing interval, CTX reductions were partially attenuated from maximal reduction of $\geq 87\%$ to approximately $\geq 45\%$ (range 45-80%), reflecting the reversibility of Prolia's effects on bone remodelling once serum levels diminish. These effects were sustained with continued treatment. Bone turnover markers generally reached pre-treatment levels within 9 months after the last dose. Upon re-initiation, reductions in CTX by denosumab were similar to those observed in patients initiating primary denosumab treatment.

Immunogenicity

In clinical studies, neutralising antibodies have not been observed for denosumab. Using a sensitive immunoassay $< 1\%$ of patients treated with denosumab for up to 5 years tested positive for non neutralising binding antibodies with no evidence of altered pharmacokinetics, toxicity, or clinical response.

Clinical efficacy and safety in postmenopausal women with osteoporosis

Efficacy and safety of Prolia administered once every 6 months for 3 years were investigated in postmenopausal women (7,808 women aged 60-91 years, of which 23.6% had prevalent vertebral fractures) with baseline bone mineral density (BMD) T-scores at the lumbar spine or total hip between -2.5 and -4.0 and a mean absolute 10-year fracture probability of 18.60% (deciles: 7.9-32.4%) for major osteoporotic fracture and 7.22% (deciles: 1.4-14.9%) for hip fracture. Women with other diseases or on therapies that may affect bone were excluded from this study. Women received calcium (at least 1,000 mg) and vitamin D (at least 400 IU) supplementation daily.

Effect on vertebral fractures

Prolia significantly reduced the risk of new vertebral fractures at 1, 2 and 3 years ($p < 0.0001$) (see table 2).

Table 2. The effect of Prolia on the risk of new vertebral fractures

	Proportion of women with fracture (%)		Absolute risk reduction (%) (95% CI)	Relative risk reduction (%) (95% CI)
	Placebo n = 3,906	Prolia n = 3,902		
0-1 year	2.2	0.9	1.4 (0.8, 1.9)	61 (42, 74)**
0-2 years	5.0	1.4	3.5 (2.7, 4.3)	71 (61,79)**
0-3 years	7.2	2.3	4.8 (3.9, 5.8)	68 (59, 74)*

* $p < 0.0001$, ** $p < 0.0001$ – exploratory analysis

Effect on hip fractures

Prolia demonstrated a 40% relative reduction (0.5% absolute risk reduction) in the risk of hip fracture over 3 years ($p < 0.05$). The incidence of hip fracture was 1.2% in the placebo group compared to 0.7% in the Prolia group at 3 years.

In a post-hoc analysis in women > 75 years, a 62% relative risk reduction was observed with Prolia (1.4% absolute risk reduction, $p < 0.01$).

Effect on all clinical fractures

Prolia significantly reduced fractures across all fracture types/groups (see table 3).

Table 3. The effect of Prolia on the risk of clinical fractures over 3 years

	Proportion of women with fracture (%) ⁺		Absolute risk reduction (%) (95% CI)	Relative risk reduction (%) (95% CI)
	Placebo n = 3,906	Prolia n = 3,902		
Any clinical fracture ¹	10.2	7.2	2.9 (1.6, 4.2)	30 (19, 41)***
Clinical vertebral fracture	2.6	0.8	1.8 (1.2, 2.4)	69 (53, 80)***
Non-vertebral fracture ²	8.0	6.5	1.5 (0.3, 2.7)	20 (5, 33)**
Major non-vertebral fracture ³	6.4	5.2	1.2 (0.1, 2.2)	20 (3, 34)*
Major osteoporotic fracture ⁴	8.0	5.3	2.7 (1.6, 3.9)	35 (22, 45)***

*p ≤ 0.05; **p = 0.0106 (secondary endpoint included in multiplicity adjustment), ***p ≤ 0.0001

⁺ Event rates based on Kaplan-Meier estimates at 3 years.

¹ Includes clinical vertebral fractures and non-vertebral fractures.

² Excludes those of the vertebrae, skull, facial, mandible, metacarpus, and finger and toe phalanges.

³ Includes pelvis, distal femur, proximal tibia, ribs, proximal humerus, forearm, and hip.

⁴ Includes clinical vertebral, hip, forearm, and humerus fractures, as defined by the WHO.

In women with baseline femoral neck BMD ≤ -2.5, Prolia reduced the risk of non-vertebral fracture (35% relative risk reduction, 4.1% absolute risk reduction, p < 0.001, exploratory analysis).

The reduction in the incidence of new vertebral fractures, hip fractures and non-vertebral fractures by Prolia over 3 years were consistent regardless of the 10-year baseline fracture risk.

Effect on bone mineral density

Prolia significantly increased BMD at all clinical sites measured, versus placebo at 1, 2 and 3 years. Prolia increased BMD by 9.2% at the lumbar spine, 6.0% at the total hip, 4.8% at the femoral neck, 7.9% at the hip trochanter, 3.5% at the distal 1/3 radius and 4.1% at the total body over 3 years (all p < 0.0001).

In clinical studies examining the effects of discontinuation of Prolia, BMD returned to approximately pre-treatment levels and remained above placebo within 18 months of the last dose. These data indicate that continued treatment with Prolia is required to maintain the effect of the medicinal product. Re-initiation of Prolia resulted in gains in BMD similar to those when Prolia was first administered.

Open-label extension study in the treatment of postmenopausal osteoporosis

A total of 4,550 women (2,343 Prolia & 2,207 placebo) who missed no more than one dose of investigational product in the pivotal study described above and completed the month 36 study visit agreed to enrol in a 7-year, multinational, multicentre, open-label, single-arm extension study to evaluate the long-term safety and efficacy of Prolia. All women in the extension study were to receive Prolia 60 mg every 6 months, as well as daily calcium (at least 1 g) and vitamin D (at least 400 IU). A total of 2,626 subjects (58% of the women included in the extension study i.e. 34% of the women included in the pivotal study) completed the extension study.

In patients treated with Prolia for up to 10 years, BMD increased from the pivotal study baseline by 21.7% at the lumbar spine, 9.2% at the total hip, 9.0% at the femoral neck, 13.0% at the trochanter and 2.8% at the distal 1/3 radius. The mean lumbar spine BMD T-score at the end of the study was -1.3 in patients treated for 10 years.

Fracture incidence was evaluated as a safety endpoint but efficacy in fracture prevention cannot be estimated due to high number of discontinuations and open-label design. The cumulative incidence of new vertebral and non-vertebral fractures were approximately 6.8% and 13.1% respectively, in

patients who remained on denosumab treatment for 10 years (n = 1,278). Patients who did not complete the study for any reason had higher on-treatment fracture rates.

Thirteen adjudicated cases of osteonecrosis of the jaw (ONJ) and two adjudicated cases of atypical fractures of the femur occurred during the extension study.

Clinical efficacy and safety in men with osteoporosis

Efficacy and safety of Prolia once every 6 months for 1 year were investigated in 242 men aged 31-84 years. Subjects with an eGFR < 30 mL/min/1.73 m² were excluded from the study. All men received calcium (at least 1,000 mg) and vitamin D (at least 800 IU) supplementation daily.

The primary efficacy variable was percent change in lumbar spine BMD, fracture efficacy was not evaluated. Prolia significantly increased BMD at all clinical sites measured, relative to placebo at 12 months: 4.8% at lumbar spine, 2.0% at total hip, 2.2% at femoral neck, 2.3% at hip trochanter, and 0.9% at distal 1/3 radius (all p < 0.05). Prolia increased lumbar spine BMD from baseline in 94.7% of men at 1 year. Significant increases in BMD at lumbar spine, total hip, femoral neck and hip trochanter were observed by 6 months (p < 0.0001).

Bone histology in postmenopausal women and men with osteoporosis

Bone histology was evaluated in 62 postmenopausal women with osteoporosis or with low bone mass who were either naïve to osteoporosis therapies or had transitioned from previous alendronate therapy following 1-3 years treatment with Prolia. Fifty nine women participated in the bone biopsy sub-study at month 24 (n = 41) and/or month 84 (n = 22) of the extension study in postmenopausal women with osteoporosis. Bone histology was also evaluated in 17 men with osteoporosis following 1 year treatment with Prolia. Bone biopsy results showed bone of normal architecture and quality with no evidence of mineralisation defects, woven bone or marrow fibrosis. Histomorphometry findings in the extension study in postmenopausal women with osteoporosis showed that the antiresorptive effects of Prolia, as measured by activation frequency and bone formation rates, were maintained over time.

Clinical efficacy and safety in patients with bone loss associated with androgen deprivation

Efficacy and safety of Prolia once every 6 months for 3 years were investigated in men with histologically confirmed non-metastatic prostate cancer receiving ADT (1,468 men aged 48-97 years) who were at increased risk of fracture (defined as > 70 years, or < 70 years with a BMD T-score at the lumbar spine, total hip, or femoral neck < -1.0 or a history of an osteoporotic fracture.) All men received calcium (at least 1,000 mg) and vitamin D (at least 400 IU) supplementation daily.

Prolia significantly increased BMD at all clinical sites measured, relative to treatment with placebo at 3 years: 7.9% at the lumbar spine, 5.7% at the total hip, 4.9% at the femoral neck, 6.9% at the hip trochanter, 6.9% at the distal 1/3 radius and 4.7% at the total body (all p < 0.0001). In a prospectively planned exploratory analysis, significant increases in BMD were observed at the lumbar spine, total hip, femoral neck and the hip trochanter 1 month after the initial dose.

Prolia demonstrated a significant relative risk reduction of new vertebral fractures: 85% (1.6% absolute risk reduction) at 1 year, 69% (2.2% absolute risk reduction) at 2 years and 62% (2.4% absolute risk reduction) at 3 years (all p < 0.01).

Clinical efficacy and safety in patients with bone loss associated with adjuvant aromatase inhibitor therapy

Efficacy and safety of Prolia once every 6 months for 2 years were investigated in women with non-metastatic breast cancer (252 women aged 35-84 years) and baseline BMD T-scores between -1.0 to -2.5 at the lumbar spine, total hip or femoral neck. All women received calcium (at least 1,000 mg) and vitamin D (at least 400 IU) supplementation daily.

The primary efficacy variable was percent change in lumbar spine BMD, fracture efficacy was not evaluated. Prolia significantly increased BMD at all clinical sites measured, relative to treatment with placebo at 2 years: 7.6% at lumbar spine, 4.7% at total hip, 3.6% at femoral neck, 5.9% at hip trochanter, 6.1% at distal 1/3 radius and 4.2% at total body (all $p < 0.0001$).

Treatment of bone loss associated with systemic glucocorticoid therapy

Efficacy and safety of Prolia were investigated in 795 patients (70% women and 30% men) aged 20 to 94 years treated with ≥ 7.5 mg daily oral prednisone (or equivalent).

Two subpopulations were studied: glucocorticoid-continuing (≥ 7.5 mg daily prednisone or its equivalent for ≥ 3 months prior to study enrolment; $n = 505$) and glucocorticoid-initiating (≥ 7.5 mg daily prednisone or its equivalent for < 3 months prior to study enrolment; $n = 290$). Patients were randomised (1:1) to receive either Prolia 60 mg subcutaneously once every 6 months or oral risedronate 5 mg once daily (active control) for 2 years. Patients received calcium (at least 1,000 mg) and vitamin D (at least 800 IU) supplementation daily.

Effect on Bone Mineral Density (BMD)

In the glucocorticoid-continuing subpopulation, Prolia demonstrated a greater increase in lumbar spine BMD compared to risedronate at 1 year (Prolia 3.6%, risedronate 2.0%; $p < 0.001$) and 2 years (Prolia 4.5%, risedronate 2.2%; $p < 0.001$). In the glucocorticoid-initiating subpopulation, Prolia demonstrated a greater increase in lumbar spine BMD compared to risedronate at 1 year (Prolia 3.1%, risedronate 0.8%; $p < 0.001$) and 2 years (Prolia 4.6%, risedronate 1.5%; $p < 0.001$).

In addition, Prolia demonstrated a significantly greater mean percent increase in BMD from baseline compared to risedronate at the total hip, femoral neck, and hip trochanter.

The study was not powered to show a difference in fractures. At 1 year, the subject incidence of new radiological vertebral fracture was 2.7% (denosumab) versus 3.2% (risedronate). The subject incidence of non-vertebral fracture was 4.3% (denosumab) versus 2.5% (risedronate). At 2 years, the corresponding numbers were 4.1% versus 5.8% for new radiological vertebral fractures and 5.3% versus 3.8% for non-vertebral fractures. Most of the fractures occurred in the GC-C subpopulation.

Paediatric population

The European Medicines Agency has waived the obligation to submit the results of studies with Prolia in all subsets of the paediatric population in the treatment of bone loss associated with sex hormone ablative therapy, and in subsets of the paediatric population below the age of 2 in the treatment of osteoporosis. See section 4.2 for information on paediatric use.

5.2 Pharmacokinetic properties

Absorption

Following subcutaneous administration of a 1.0 mg/kg dose, which approximates the approved 60 mg dose, exposure based on AUC was 78% as compared to intravenous administration at the same dose level. For a 60 mg subcutaneous dose, maximum serum denosumab concentrations (C_{max}) of 6 mcg/mL (range 1-17 μ g/mL) occurred in 10 days (range 2-28 days).

Biotransformation

Denosumab is composed solely of amino acids and carbohydrates as native immunoglobulin and is unlikely to be eliminated via hepatic metabolic mechanisms. Its metabolism and elimination are expected to follow the immunoglobulin clearance pathways, resulting in degradation to small peptides and individual amino acids.

Elimination

After C_{max} , serum levels declined with a half-life of 26 days (range 6-52 days) over a period of 3 months (range 1.5-4.5 months). Fifty-three percent (53%) of patients had no measurable amounts of denosumab detected at 6 months post-dose.

No accumulation or change in denosumab pharmacokinetics with time was observed upon subcutaneous multiple-dosing of 60 mg once every 6 months. Denosumab pharmacokinetics were not affected by the formation of binding antibodies to denosumab and were similar in men and women. Age (28-87 years), race and disease state (low bone mass or osteoporosis; prostate or breast cancer) do not appear to significantly affect the pharmacokinetics of denosumab.

A trend was observed between higher body weight and lower exposure based on AUC and C_{max} . However, the trend is not considered clinically important, since pharmacodynamic effects based on bone turnover markers and BMD increases were consistent across a wide range of body weight.

Linearity/non-linearity

In dose ranging studies, denosumab exhibited non-linear, dose-dependent pharmacokinetics, with lower clearance at higher doses or concentrations, but approximately dose-proportional increases in exposures for doses of 60 mg and greater.

Renal impairment

In a study of 55 patients with varying degrees of renal function, including patients on dialysis, the degree of renal impairment had no effect on the pharmacokinetics of denosumab.

Hepatic impairment

No specific study in patients with hepatic impairment was performed. In general, monoclonal antibodies are not eliminated via hepatic metabolic mechanisms. The pharmacokinetics of denosumab is not expected to be affected by hepatic impairment.

Paediatric population

The pharmacokinetic profile in paediatric populations has not been assessed.

5.3 Preclinical safety data

In single and repeated dose toxicity studies in cynomolgus monkeys, denosumab doses resulting in 100 to 150 times greater systemic exposure than the recommended human dose had no impact on cardiovascular physiology, male or female fertility, or produced specific target organ toxicity.

Standard tests to investigate the genotoxicity potential of denosumab have not been evaluated, since such tests are not relevant for this molecule. However, due to its character it is unlikely that denosumab has any potential for genotoxicity.

The carcinogenic potential of denosumab has not been evaluated in long-term animal studies.

In preclinical studies conducted in knockout mice lacking RANK or RANKL, impairment of lymph node formation was observed in the foetus. An absence of lactation due to inhibition of mammary gland maturation (lobulo-alveolar gland development during pregnancy) was also observed in knockout mice lacking RANK or RANKL.

In a study of cynomolgus monkeys dosed with denosumab during the period equivalent to the first trimester at AUC exposures up to 99-fold higher than the human dose (60 mg every 6 months), there was no evidence of maternal or foetal harm. In this study, foetal lymph nodes were not examined.

In another study of cynomolgus monkeys dosed with denosumab throughout pregnancy at AUC exposures 119-fold higher than the human dose (60 mg every 6 months), there were increased stillbirths and postnatal mortality; abnormal bone growth resulting in reduced bone strength, reduced haematopoiesis, and tooth malalignment; absence of peripheral lymph nodes; and decreased neonatal growth. A no observed adverse effect level for reproductive effects was not established. Following a 6 month period after birth, bone related changes showed recovery and there was no effect on tooth eruption. However, the effects on lymph nodes and tooth malalignment persisted, and minimal to moderate mineralisation in multiple tissues was seen in one animal (relation to treatment uncertain). There was no evidence of maternal harm prior to labour; adverse maternal effects occurred infrequently during labour. Maternal mammary gland development was normal.

In preclinical bone quality studies in monkeys on long-term denosumab treatment, decreases in bone turnover were associated with improvement in bone strength and normal bone histology. Calcium levels were transiently decreased and parathyroid hormone levels transiently increased in ovariectomised monkeys treated with denosumab.

In male mice genetically engineered to express huRANKL (knock-in mice), which were subjected to a transcortical fracture, denosumab delayed the removal of cartilage and remodelling of the fracture callus compared to control, but biomechanical strength was not adversely affected.

Knockout mice (see section 4.6) lacking RANK or RANKL exhibited decreased body weight, reduced bone growth and lack of tooth eruption. In neonatal rats, inhibition of RANKL (target of denosumab therapy) with high doses of a construct of osteoprotegerin bound to Fc (OPG-Fc) was associated with inhibition of bone growth and tooth eruption. These changes were partially reversible in this model when dosing with RANKL inhibitors was discontinued. Adolescent primates dosed with denosumab at 27 and 150 times (10 and 50 mg/kg dose) the clinical exposure had abnormal growth plates. Therefore, treatment with denosumab may impair bone growth in children with open growth plates and may inhibit eruption of dentition.

6. PHARMACEUTICAL PARTICULARS

6.1 List of excipients

Acetic acid, glacial*

Sodium hydroxide (for pH adjustment)*

Sorbitol (E420)

Polysorbate 20

Water for injections

* Acetate buffer is formed by mixing acetic acid with sodium hydroxide

6.2 Incompatibilities

In the absence of compatibility studies, this medicinal product must not be mixed with other medicinal products.

6.3 Shelf life

3 years.

Once removed from the refrigerator, Prolia may be stored at room temperature (up to 25°C) for up to 30 days in the original container. It must be used within this 30 days period.

6.4 Special precautions for storage

Store in a refrigerator (2°C – 8°C).

Do not freeze.

Keep the container in the outer carton in order to protect from light.

6.5 Nature and contents of container

One mL solution in a single use pre-filled syringe made from type I glass with stainless steel 27 gauge needle, with or without needle guard.

The needle cover of the pre-filled syringe contains dry natural rubber, which is a derivative of latex (see section 4.4).

Pack size of one pre-filled syringe, presented in blistered (pre-filled syringe with or without a needle guard) or unblistered packaging (pre-filled syringe without a needle guard only).

Not all pack sizes may be marketed.

6.6 Special precautions for disposal and other handling

- Before administration, the solution should be inspected. Do not inject the solution if it contains particles, or is cloudy or discoloured.
- Do not shake.
- To avoid discomfort at the site of injection, allow the pre-filled syringe to reach room temperature (up to 25°C) before injecting and inject slowly.
- Inject the entire contents of the pre-filled syringe.

Any unused medicinal product or waste material should be disposed of in accordance with local requirements.

7. MARKETING AUTHORISATION HOLDER

Amgen Europe B.V.
Minervum 7061
NL-4817 ZK Breda
The Netherlands

8. MARKETING AUTHORISATION NUMBER(S)

EU/1/10/618/001
EU/1/10/618/002
EU/1/10/618/003

9. DATE OF FIRST AUTHORISATION/RENEWAL OF THE AUTHORISATION

Date of first authorisation: 26 May 2010

Date of latest renewal: 15 January 2015

10. DATE OF REVISION OF THE TEXT

Detailed information on this medicinal product is available on the website of the European Medicines Agency <http://www.ema.europa.eu>

ANNEX II

- A. MANUFACTURER OF THE BIOLOGICAL ACTIVE
SUBSTANCE AND MANUFACTURERS RESPONSIBLE
FOR BATCH RELEASE**
- B. CONDITIONS OR RESTRICTIONS REGARDING SUPPLY
AND USE**
- C. OTHER CONDITIONS AND REQUIREMENTS OF THE
MARKETING AUTHORISATION**
- D. CONDITIONS OR RESTRICTIONS WITH REGARD TO
THE SAFE AND EFFECTIVE USE OF THE MEDICINAL
PRODUCT**

**A. MANUFACTURER OF THE BIOLOGICAL ACTIVE SUBSTANCE
AND MANUFACTURERS RESPONSIBLE FOR BATCH RELEASE**

Name and address of the manufacturer of the biological active substance

Amgen Singapore Manufacturing
1 Tuas View Drive
Singapore 637026

Name and address of the manufacturers responsible for batch release

Amgen Europe B.V.
Minervum 7061
NL-4817 ZK Breda
The Netherlands

Amgen Technology (Ireland) Unlimited Company
Pottery Road
Dun Laoghaire
Co Dublin
Ireland

Amgen NV
Telecomlaan 5-7
1831 Diegem
Belgium

The printed package leaflet of the medicinal product must state the name and address of the manufacturer responsible for the release of the concerned batch.

B. CONDITIONS OR RESTRICTIONS REGARDING SUPPLY AND USE

Medicinal product subject to medical prescription.

**C. OTHER CONDITIONS AND REQUIREMENTS OF THE MARKETING
AUTHORISATION**

• **Periodic Safety Update Reports**

The requirements for submission of periodic safety update reports for this medicinal product are set out in the list of Union reference dates (EURD list) provided for under Article 107c(7) of Directive 2001/83/EC and any subsequent updates published on the European medicines web-portal.

**D. CONDITIONS OR RESTRICTIONS WITH REGARD TO THE SAFE
AND EFFECTIVE USE OF THE MEDICINAL PRODUCT**

• **Risk Management Plan (RMP)**

The MAH shall perform the required pharmacovigilance activities and interventions detailed in the agreed RMP presented in Module 1.8.2 of the Marketing Authorisation and any agreed subsequent updates of the RMP.

An updated RMP should be submitted:

- At the request of the European Medicines Agency;

- Whenever the risk management system is modified, especially as the result of new information being received that may lead to a significant change to the benefit-risk profile or as the result of an important (pharmacovigilance or risk minimisation) milestone being reached.
- **Additional risk minimisation measures**

The MAH shall ensure that a patient reminder card regarding osteonecrosis of the jaw is implemented.

ANNEX III
LABELLING AND PACKAGE LEAFLET

A. LABELLING

PARTICULARS TO APPEAR ON THE OUTER PACKAGING

PRE-FILLED SYRINGE CARTON

1. NAME OF THE MEDICINAL PRODUCT

Prolia 60 mg solution for injection in pre-filled syringe
denosumab

2. STATEMENT OF ACTIVE SUBSTANCE(S)

1 mL pre-filled syringe containing 60 mg of denosumab (60 mg/mL).

3. LIST OF EXCIPIENTS

Acetic acid, glacial, sodium hydroxide, sorbitol (E420), polysorbate 20, water for injections.

4. PHARMACEUTICAL FORM AND CONTENTS

Solution for injection

One pre-filled syringe with automatic needle guard.

One pre-filled syringe.

5. METHOD AND ROUTE(S) OF ADMINISTRATION

Subcutaneous use.

Important: read the package leaflet before handling pre-filled syringe.

Do not shake.

Read the package leaflet before use.

6. SPECIAL WARNING THAT THE MEDICINAL PRODUCT MUST BE STORED OUT OF THE SIGHT AND REACH OF CHILDREN

Keep out of the sight and reach of children.

7. OTHER SPECIAL WARNING(S), IF NECESSARY

8. EXPIRY DATE

EXP

9. SPECIAL STORAGE CONDITIONS

Store in a refrigerator.

Do not freeze.

Keep the container in the outer carton in order to protect from light.

10. SPECIAL PRECAUTIONS FOR DISPOSAL OF UNUSED MEDICINAL PRODUCTS OR WASTE MATERIALS DERIVED FROM SUCH MEDICINAL PRODUCTS, IF APPROPRIATE

11. NAME AND ADDRESS OF THE MARKETING AUTHORISATION HOLDER

Amgen Europe B.V.
Minervum 7061,
NL-4817 ZK Breda,
The Netherlands

12. MARKETING AUTHORISATION NUMBER(S)

EU/1/10/618/001 1 pre-filled syringe (blistered)
EU/1/10/618/002 1 pre-filled syringe (unblistered)
EU/1/10/618/003 1 pre-filled syringe with automatic needle guard (blistered)

13. BATCH NUMBER

Lot

14. GENERAL CLASSIFICATION FOR SUPPLY

15. INSTRUCTIONS ON USE

16. INFORMATION IN BRAILLE

Prolia

17. UNIQUE IDENTIFIER – 2D BARCODE

2D barcode carrying the unique identifier included.

18. UNIQUE IDENTIFIER - HUMAN READABLE DATA

PC
SN
NN

MINIMUM PARTICULARS TO APPEAR ON BLISTERS OR STRIPS

BLISTERED PRE-FILLED SYRINGE

1. NAME OF THE MEDICINAL PRODUCT

Prolia 60 mg injection
denosumab

2. NAME OF THE MARKETING AUTHORISATION HOLDER

Amgen Europe B.V.

3. EXPIRY DATE

EXP

4. BATCH NUMBER

Lot

5. OTHER

SC

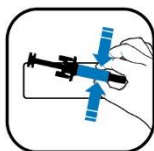

**MINIMUM PARTICULARS TO APPEAR ON SMALL IMMEDIATE PACKAGING UNITS
PRE-FILLED SYRINGE LABEL (UNBLISTERED)**

1. NAME OF THE MEDICINAL PRODUCT AND ROUTE(S) OF ADMINISTRATION

Prolia 60 mg injection
denosumab
SC

2. METHOD OF ADMINISTRATION

3. EXPIRY DATE

EXP

4. BATCH NUMBER

Lot

5. CONTENTS BY WEIGHT, BY VOLUME OR BY UNIT

1 ml

6. OTHER

**MINIMUM PARTICULARS TO APPEAR ON SMALL IMMEDIATE PACKAGING UNITS
PRE-FILLED SYRINGE LABEL WITH OR WITHOUT NEEDLE GUARD (BLISTERED)**

1. NAME OF THE MEDICINAL PRODUCT AND ROUTE(S) OF ADMINISTRATION

Prolia 60 mg
denosumab
SC

2. METHOD OF ADMINISTRATION

3. EXPIRY DATE

EXP

4. BATCH NUMBER

Lot

5. CONTENTS BY WEIGHT, BY VOLUME OR BY UNIT

1 ml

6. OTHER

REMINDER STICKERS TEXT (included in pack)

Next injection

Prolia 60 mg injection
denosumab

SC

Every 6 months

Amgen Europe B.V.

<.../.../...>

B. PACKAGE LEAFLET

Package leaflet: Information for the user

Prolia 60 mg solution for injection in pre-filled syringe denosumab

Read all of this leaflet carefully before you start using this medicine because it contains important information for you.

- Keep this leaflet. You may need to read it again.
- If you have any further questions, ask your doctor or pharmacist.
- This medicine has been prescribed for you only. Do not pass it on to others. It may harm them, even if their signs of illness are the same as yours.
- If you get any side effects, talk to your doctor or pharmacist. This includes any possible side effects not listed in this leaflet. See section 4.
- Your doctor will give you a patient reminder card, which contains important safety information you need to be aware of before and during your treatment with Prolia.

What is in this leaflet

1. What Prolia is and what it is used for
2. What you need to know before you use Prolia
3. How to use Prolia
4. Possible side effects
5. How to store Prolia
6. Contents of the pack and other information

1. What Prolia is and what it is used for

What Prolia is and how it works

Prolia contains denosumab, a protein (monoclonal antibody) that interferes with the action of another protein, in order to treat bone loss and osteoporosis. Treatment with Prolia makes bone stronger and less likely to break.

Bone is a living tissue and is renewed all the time. Oestrogen helps keep bones healthy. After the menopause, oestrogen level drops which may cause bones to become thin and fragile. This can eventually lead to a condition called osteoporosis. Osteoporosis can also occur in men due to a number of causes including ageing and/or a low level of the male hormone, testosterone. It can also occur in patients receiving glucocorticoids. Many patients with osteoporosis have no symptoms, but they are still at risk of breaking bones, especially in the spine, hips and wrists.

Surgery or medicines that stop the production of oestrogen or testosterone used to treat patients with breast or prostate cancer can also lead to bone loss. The bones become weaker and break more easily.

What Prolia is used for

Prolia is used to treat:

- osteoporosis in women after the menopause (postmenopausal) and men who have an increased risk of fracture (broken bones), reducing the risk of spinal, non-spinal and hip fractures.
- bone loss that results from a reduction in hormone (testosterone) level caused by surgery or treatment with medicines in patients with prostate cancer.
- bone loss that results from long-term treatment with glucocorticoids in patients who have an increased risk of fracture.

2. What you need to know before you use Prolia

Do not use Prolia

- if you have low calcium levels in the blood (hypocalcaemia).
- if you are allergic to denosumab or any of the other ingredients of this medicine (listed in section 6).

Warnings and precautions

Talk to your doctor or pharmacist before using Prolia

Whilst being treated with Prolia you may develop a skin infection with symptoms such as a swollen, red area of skin, most commonly in the lower leg, that feels hot and tender (cellulitis), and possibly with symptoms of fever. Please tell your doctor immediately if you develop any of these symptoms.

Please tell your doctor if you have an allergy to latex (the needle cover on the pre-filled syringe contains a derivative of latex).

You should also take calcium and vitamin D supplements while being on treatment with Prolia. Your doctor will discuss this with you.

You may have low levels of calcium in your blood while receiving Prolia. Please tell your doctor immediately if you notice any of the following symptoms: spasms, twitches, or cramps in your muscle, and/or numbness or tingling in your fingers, toes or around your mouth, and/or seizures, confusion, or loss of consciousness.

Tell your doctor if you have or have ever had severe kidney problems, kidney failure or have needed dialysis or are taking medicines called glucocorticoids (such as prednisolone or dexamethasone), which may increase your risk of getting low blood calcium if you do not take calcium supplements.

Problems with your mouth, teeth or jaw

A side effect called osteonecrosis of the jaw (ONJ) (bone damage in the jaw) has been reported rarely (may affect up to 1 in 1,000 people) in patients receiving Prolia for osteoporosis. The risk of ONJ increases in patients treated for a long time (may affect up to 1 in 200 people if treated for 10 years). ONJ can also occur after stopping treatment. It is important to try to prevent ONJ developing as it may be a painful condition that can be difficult to treat. In order to reduce the risk of developing ONJ, there are some precautions you should take.

Before receiving treatment, tell your doctor or nurse (health care professional) if you:

- have any problems with your mouth or teeth such as poor dental health, gum disease, or a planned tooth extraction.
- don't receive routine dental care or have not had a dental check-up for a long time.
- are a smoker (as this may increase the risk of dental problems).
- have previously been treated with a bisphosphonate (used to treat or prevent bone disorders).
- are taking medicines called corticosteroids (such as prednisolone or dexamethasone).
- have cancer.

Your doctor may ask you to undergo a dental examination before you start treatment with Prolia.

While being treated, you should maintain good oral hygiene and receive routine dental check-ups. If you wear dentures you should make sure these fit properly. If you are under dental treatment or will undergo dental surgery (e.g. tooth extractions), inform your doctor about your dental treatment and tell your dentist that you are being treated with Prolia.

Contact your doctor and dentist immediately if you experience any problems with your mouth or teeth such as loose teeth, pain or swelling, or non-healing of sores or discharge, as these could be signs of ONJ.

Unusual thigh bone fractures

Some people have developed unusual fractures in their thigh bone while being treated with Prolia. Contact your doctor if you experience new or unusual pain in your hip, groin, or thigh.

Children and adolescents

Prolia is not recommended for children and adolescents under 18 years of age. The use of Prolia in children and adolescents has not been studied.

Other medicines and Prolia

Tell your doctor or pharmacist if you are taking, have recently taken or might take any other medicines. It is especially important that you tell your doctor if you are being treated with another medicine containing denosumab.

You should not take Prolia together with another medicine containing denosumab.

Pregnancy and breast-feeding

Prolia has not been tested in pregnant women. It is important to tell your doctor if you are pregnant; think you may be pregnant; or plan to get pregnant. Prolia is not recommended for use if you are pregnant. Women of child-bearing potential should use effective methods of contraception while being treated with Prolia and for at least 5 months after stopping treatment with Prolia.

If you become pregnant during treatment with Prolia or less than 5 months after stopping treatment with Prolia, please inform your doctor.

It is not known whether Prolia is excreted in breast milk. It is important to tell your doctor if you are breast-feeding or plan to do so. Your doctor will then help you decide whether to stop breast-feeding, or whether to stop taking Prolia, considering the benefit of breast-feeding to the baby and the benefit of Prolia to the mother.

If you are breast-feeding during Prolia treatment, please inform your doctor.

Ask your doctor or pharmacist for advice before taking any medicine.

Driving and using machines

Prolia has no or negligible influence on the ability to drive and use machines.

Prolia contains sorbitol

This medicine contains 47 mg sorbitol in each mL of solution.

Prolia contains sodium

This medicine contains less than 1 mmol sodium (23 mg) per 60 mg, i.e. essentially 'sodium-free'.

3. How to use Prolia

The recommended dose is one pre-filled syringe of 60 mg administered once every 6 months, as a single injection under the skin (subcutaneous). The best places to inject are the top of your thighs and the abdomen. Your carer can also use the outer area of your upper arm. Each pack of Prolia contains a reminder card with stickers that can be removed from the carton. Use the peel-off stickers to mark the next injection date on your personal calendar and/or the reminder card to keep a record of the next injection date.

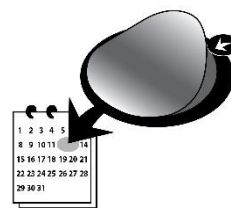

You should also take calcium and vitamin D supplements while being on treatment with Prolia. Your doctor will discuss this with you.

Your doctor may decide that it is best for you or a carer to inject Prolia. Your doctor or healthcare provider will show you or your carer how to use Prolia. For instructions on how to inject Prolia, please read the section at the end of this leaflet.

If you forget to use Prolia

If a dose of Prolia is missed, the injection should be administered as soon as possible. Thereafter, injections should be scheduled every 6 months from the date of the last injection.

If you stop using Prolia

To get the most benefit from your treatment, it is important to use Prolia for as long as your doctor prescribes it for you. Please talk to your doctor before you consider stopping the treatment.

4. Possible side effects

Like all medicines, this medicine can cause side effects, although not everybody gets them.

Uncommonly, patients receiving Prolia may develop skin infections (predominantly cellulitis). **Please tell your doctor immediately** if you develop any of these symptoms while being on treatment with Prolia: swollen, red area of skin, most commonly in the lower leg, that feels hot and tender, and possibly with symptoms of fever.

Rarely, patients receiving Prolia may develop pain in the mouth and/or jaw, swelling or non-healing of sores in the mouth or jaw, discharge, numbness or a feeling of heaviness in the jaw, or loosening of a tooth. These could be signs of bone damage in the jaw (osteonecrosis). **Tell your doctor and dentist immediately** if you experience such symptoms while being treated with Prolia or after stopping treatment.

Rarely, patients receiving Prolia may have low calcium levels in the blood (hypocalcaemia). Symptoms include spasms, twitches, or cramps in your muscles, and/or numbness or tingling in your fingers, toes or around your mouth and/or seizures, confusion, or loss of consciousness. If any of these apply to you, **tell your doctor immediately**. Low calcium in the blood may also lead to a change in heart rhythm called QT prolongation which is seen by electrocardiogram (ECG).

Rarely unusual fractures of the thigh bone may occur in patients receiving Prolia. **Contact your doctor** if you experience new or unusual pain in your hip, groin or thigh as this may be an early indication of a possible fracture of the thigh bone.

Rarely, allergic reactions may occur in patients receiving Prolia. Symptoms include swelling of the face, lips, tongue, throat or other parts of the body; rash, itching or hives on the skin, wheezing or

difficulty breathing. **Please tell your doctor** if you develop any of these symptoms while being treated with Prolia.

Very common side effects (may affect more than 1 in 10 people):

- bone, joint, and/or muscle pain which is sometimes severe,
- arm or leg pain (pain in extremity).

Common side effects (may affect up to 1 in 10 people):

- painful urination, frequent urination, blood in the urine, inability to hold your urine,
- upper respiratory tract infection,
- pain, tingling or numbness that moves down your leg (sciatica),
- constipation,
- abdominal discomfort,
- rash,
- skin condition with itching, redness and/or dryness (eczema).

Uncommon side effects (may affect up to 1 in 100 people):

- fever, vomiting and abdominal pain or discomfort (diverticulitis),
- ear infection.

Not known (frequency cannot be estimated from the available data):

- Talk to your doctor if you have ear pain, discharge from the ear and/or an ear infection. These could be signs of bone damage in the ear.

Reporting of side effects

If you get any side effects, talk to your doctor or pharmacist. This includes any possible side effects not listed in this leaflet. You can also report side effects directly via [the national reporting system listed in Appendix V](#). By reporting side effects you can help provide more information on the safety of this medicine.

5. How to store Prolia

Keep this medicine out of the sight and reach of children.

Do not use this medicine after the expiry date which is stated on the label and carton after EXP. The expiry date refers to the last day of that month.

Store in a refrigerator (2°C – 8°C).

Do not freeze.

Keep the container in the outer carton in order to protect from light.

Do not shake.

Your pre-filled syringe may be left outside the refrigerator to reach room temperature (up to 25°C) before injection. This will make the injection more comfortable. Once your syringe has been left to reach room temperature (up to 25°C), it must be used within 30 days.

Do not throw away any medicines via wastewater or household waste. Ask your pharmacist how to throw away medicines you no longer use. These measures will help to protect the environment.

6. Contents of the pack and other information

What Prolia contains

- The active substance is denosumab. Each 1 mL pre-filled syringe contains 60 mg of denosumab (60 mg/mL).
- The other ingredients are acetic acid, glacial, sodium hydroxide, sorbitol (E420), polysorbate 20 and water for injections.

What Prolia looks like and contents of the pack

Prolia is a clear, colourless to slightly yellow solution for injection provided in a ready to use pre-filled syringe.

Each pack contains one pre-filled syringe with a needle guard.

Each pack contains one pre-filled syringe.

Not all pack sizes may be marketed.

Marketing Authorisation Holder and Manufacturer

Amgen Europe B.V.
Minervum 7061
4817 ZK Breda
The Netherlands

Marketing Authorisation Holder

Amgen Europe B.V.
Minervum 7061
4817 ZK Breda
The Netherlands

Manufacturer

Amgen Technology (Ireland) Unlimited Company
Pottery Road
Dun Laoghaire
Co Dublin
Ireland

Manufacturer

Amgen NV
Telecomlaan 5-7
1831 Diegem
Belgium

For any information about this medicine, please contact the local representative of the Marketing Authorisation Holder.

België/Belgique/Belgien

s.a. Amgen n.v.
Tel/Tél: +32 (0)2 7752711

България

Амджен България ЕООД
Тел.: +359 (0)2 424 7440

Lietuva

Amgen Switzerland AG Vilniaus filialas
Tel: +370 5 219 7474

Luxembourg/Luxemburg

s.a. Amgen
Belgique/Belgien
Tel/Tél: +32 (0)2 7752711

Česká republika

Amgen s.r.o.
Tel: +420 221 773 500

Danmark

Amgen, filial af Amgen AB, Sverige
Tlf: +45 39617500

Deutschland

AMGEN GmbH
Tel.: +49 89 1490960

Eesti

Amgen Switzerland AG Vilniaus filialas
Tel: +372 586 09553

Ελλάδα

Amgen Ελλάς Φαρμακευτικά Ε.Π.Ε.
Τηλ.: +30 210 3447000

España

Amgen S.A.
Tel: +34 93 600 18 60

France

Amgen S.A.S.
Tél: +33 (0)9 69 363 363

Hrvatska

Amgen d.o.o.
Tel: +385 (0)1 562 57 20

Ireland

Amgen Limited
United Kingdom
Tel: +44 (0)1223 420305

Ísland

Vistor hf.
Sími: +354 535 7000

Italia

Amgen S.r.l.
Tel: +39 02 6241121

Κύπρος

C.A. Papaellinas Ltd
Τηλ: +357 22741 741

Latvija

Amgen Switzerland AG Rīgas filiāle
Tel: +371 257 25888

Magyarország

Amgen Kft.
Tel.: +36 1 35 44 700

Malta

Amgen B.V.
The Netherlands
Tel: +31 (0)76 5732500

Nederland

Amgen B.V.
Tel: +31 (0)76 5732500

Norge

Amgen AB
Tlf: +47 23308000

Österreich

Amgen GmbH
Tel: +43 (0)1 50 217

Polska

Amgen Biotechnologia Sp. z o.o.
Tel.: +48 22 581 3000

Portugal

Amgen Biofarmacêutica, Lda.
Tel: +351 21 4220550

România

Amgen România SRL
Tel: +4021 527 3000

Slovenija

AMGEN zdravila d.o.o.
Tel: +386 (0)1 585 1767

Slovenská republika

Amgen Slovakia s.r.o.
Tel: +421 2 321 114 49

Suomi/Finland

Amgen AB, sivuliike Suomessa/Amgen AB, filial
i Finland
Puh/Tel: +358 (0)9 54900500

Sverige

Amgen AB
Tel: +46 (0)8 6951100

United Kingdom

Amgen Limited
Tel: +44 (0)1223 420305

This leaflet was last revised in

Other sources of information

Detailed information on this medicine is available on the European Medicines Agency web site:

<http://www.ema.europa.eu/>

Instructions for use:

Guide to parts

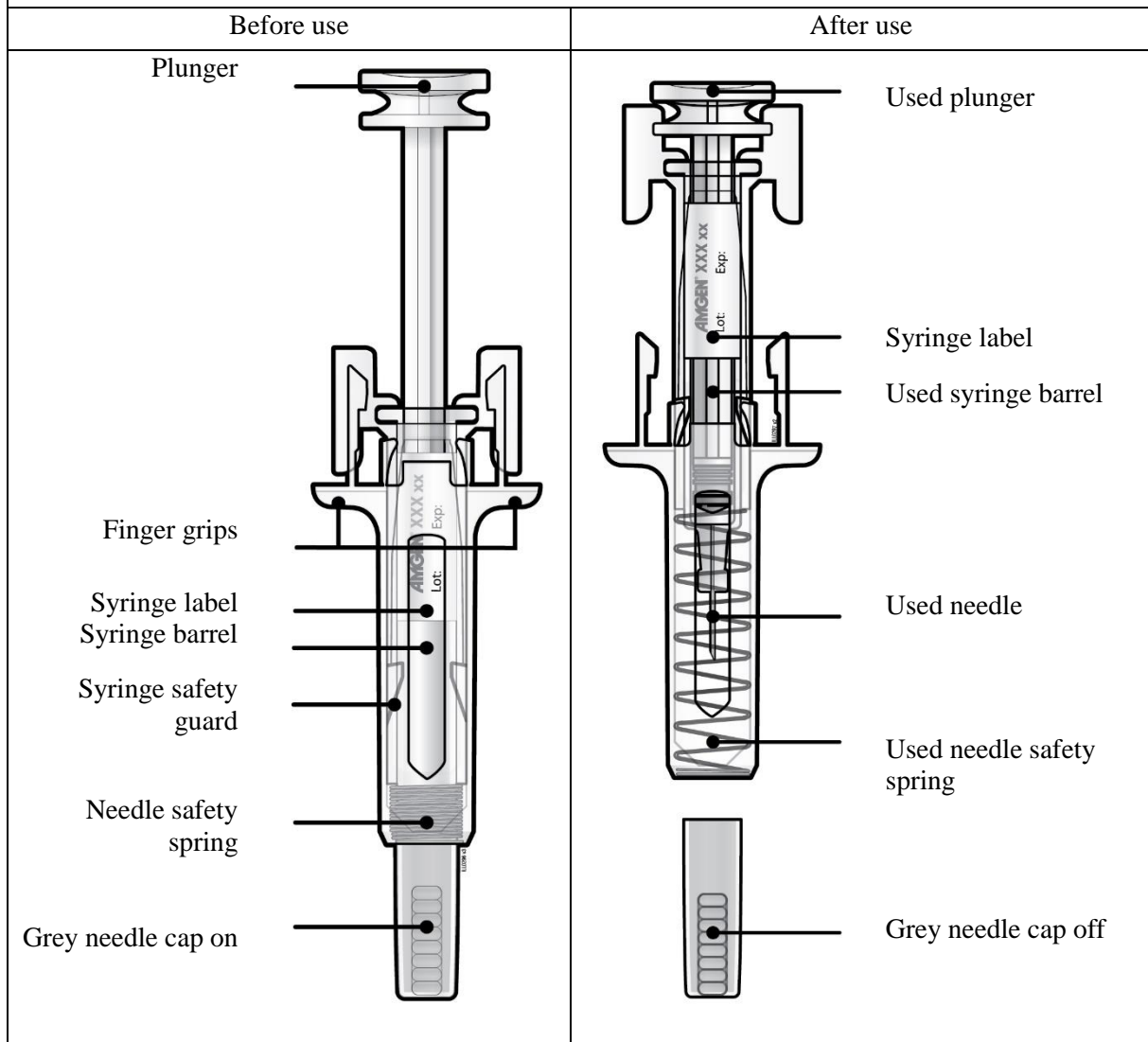

Important

Before you use a Prolia pre-filled syringe with automatic needle guard, read this important information:

- It is important that you do not try to give yourself the injection unless you have received training from your doctor or healthcare provider.
- Prolia is given as an injection into the tissue just under the skin (subcutaneous injection).
- Tell your doctor if you have an allergy to latex (the needle cap on the pre-filled syringe contains a derivative of latex).
- ✗ **Do not** remove the grey needle cap from the pre-filled syringe until you are ready to inject.
- ✗ **Do not** use the pre-filled syringe if it has been dropped on a hard surface. Use a new pre-filled syringe and call your doctor or healthcare provider.
- ✗ **Do not** attempt to activate the pre-filled syringe prior to injection.
- ✗ **Do not** attempt to remove the clear pre-filled syringe safety guard from the pre-filled syringe.

Call your doctor or healthcare provider if you have any questions.

Step 1: Prepare

A Remove the pre-filled syringe tray from the package and gather the supplies needed for your injection: alcohol wipes, a cotton ball or gauze pad, a plaster and a sharps disposal container (not included).

For a more comfortable injection, leave the pre-filled syringe at room temperature for about 30 minutes before injecting. Wash your hands thoroughly with soap and water.

On a clean, well-lit work surface, place the new pre-filled syringe and the other supplies.

- ✗ **Do not** try to warm the syringe by using a heat source such as hot water or microwave.
- ✗ **Do not** leave the pre-filled syringe exposed to direct sunlight.
- ✗ **Do not** shake the pre-filled syringe.
- **Keep the pre-filled syringe out of the sight and reach of children.**

B Open the tray, peeling away the cover. Grab the pre-filled syringe safety guard to remove the pre-filled syringe from the tray.

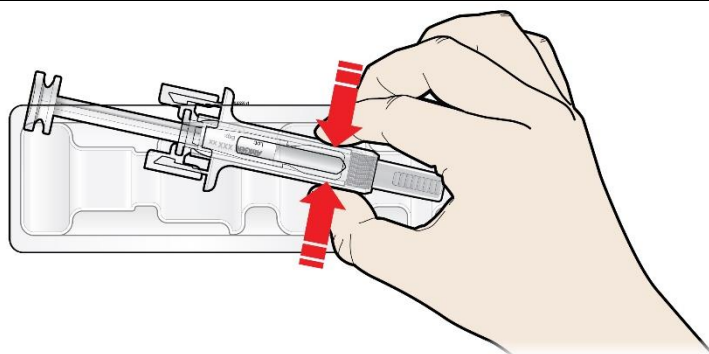

Grab here

For safety reasons:

- ✗ **Do not** grasp the plunger.
- ✗ **Do not** grasp the grey needle cap.

C Inspect the medicine and pre-filled syringe.

Medicine

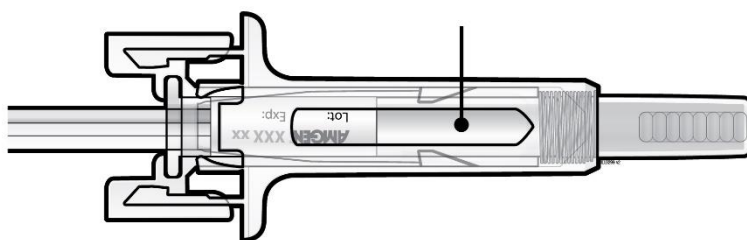

- ✗ **Do not** use the pre-filled syringe if:
 - The medicine is cloudy or there are particles in it. It must be a clear, colourless to slightly yellow solution.
 - Any part appears cracked or broken.
 - The grey needle cap is missing or not securely attached.
 - The expiry date printed on the label has passed the last day of the month shown.

In all cases, call your doctor or healthcare provider.

Step 2: **Get ready**

A Wash your hands thoroughly. Prepare and clean your injection site.

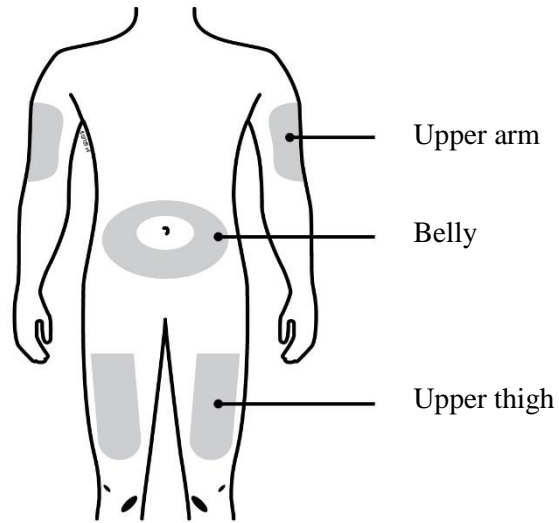

You can use:

- Upper part of your thigh.
- Belly, except for a 5 cm (2-inch) area right around your belly button.
- Outer area of upper arm (only if someone else is giving you the injection).

Clean the injection site with an alcohol wipe. Let your skin dry.

✗ Do not touch the injection site before injecting.



Do not inject into areas where the skin is tender, bruised, red, or hard. Avoid injecting into areas with scars or stretch marks.

B Carefully pull the grey needle cap straight out and away from your body.

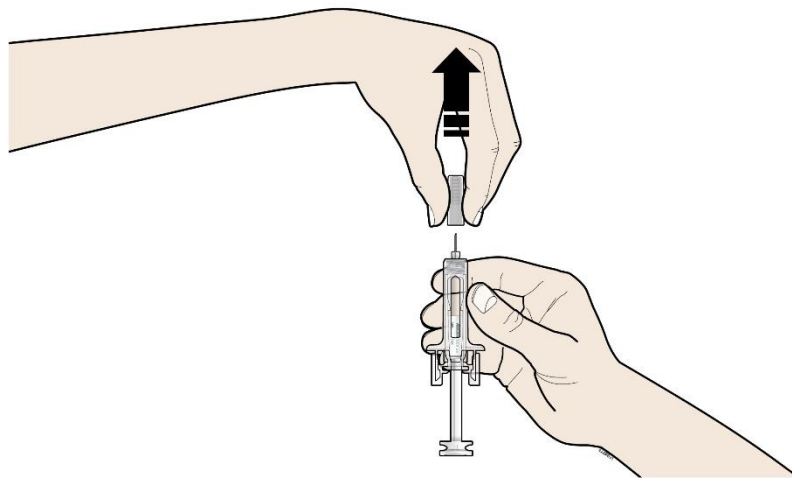

C Pinch your injection site to create a firm surface.

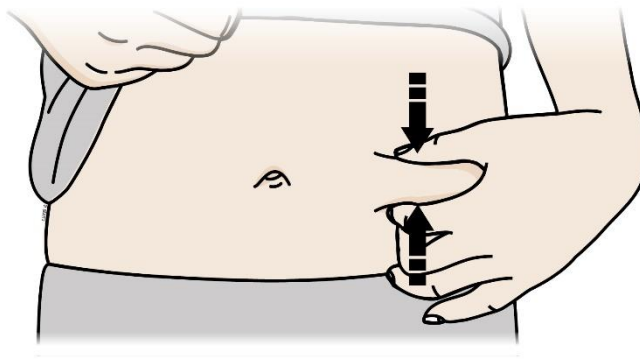

It is important to keep the skin pinched when injecting.

Step 3: Inject

A Hold the pinch. INSERT the needle into skin.

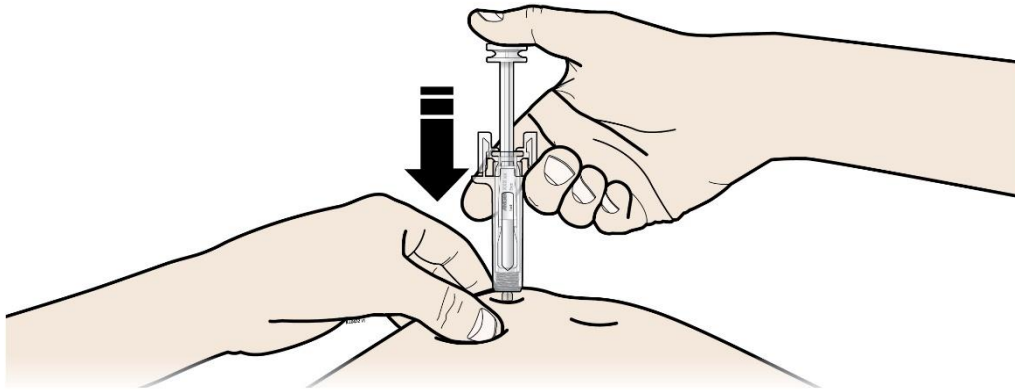

x Do not touch the cleaned area of the skin.

B PUSH the plunger with slow and constant pressure until you feel or hear a “snap”. Push all the way down through the snap.

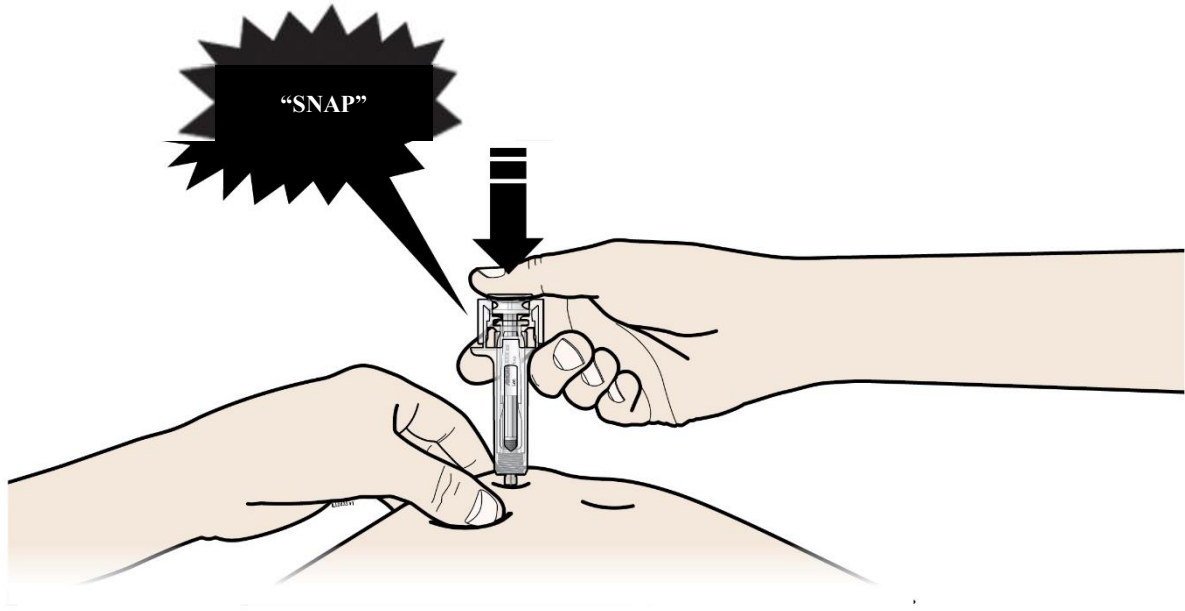

It is important to push down through the “snap” to deliver your full dose.

C RELEASE your thumb. Then LIFT the syringe off skin.

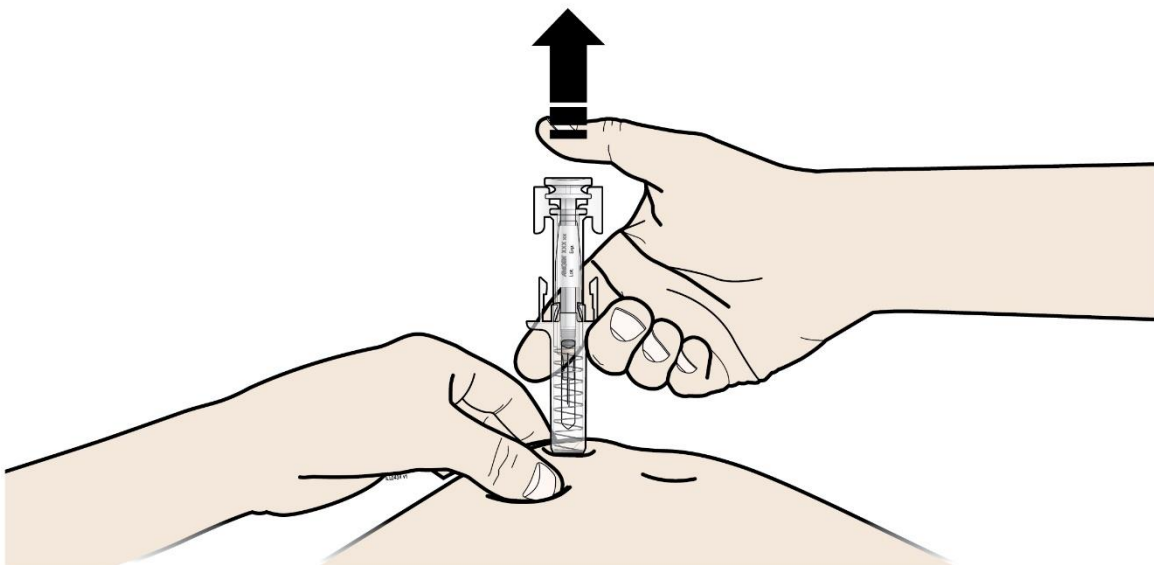

After releasing the plunger, the pre-filled syringe safety guard will safely cover the injection needle.

x Do not put the grey needle cap back on used pre-filled syringes.

Step 4: **Finish**

A Discard the used pre-filled syringe and other supplies in a sharps disposal container.

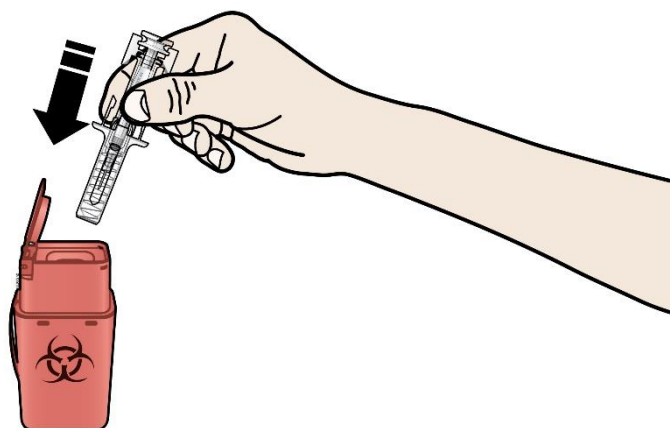

Medicines should be disposed of in accordance with local requirements. Ask your pharmacist how to dispose of medicines no longer required. These measures will help to protect the environment.

Keep the syringe and sharps disposal container out of sight and reach of children.

✘ **Do not** reuse the pre-filled syringe.

✘ **Do not** recycle pre-filled syringes or throw them into household waste.

B Examine the injection site.

If there is blood, press a cotton ball or gauze pad on your injection site. **Do not** rub the injection site. Apply a plaster if needed.

Instructions for injecting with the Prolia pre-filled syringe

This section contains information on how to use the Prolia pre-filled syringe. **It is important that you or your carer do not give the injection unless training from your doctor or healthcare provider has been received.** Always wash your hands before every injection. If you have questions about how to inject, please ask your doctor or healthcare provider for assistance.

Before you begin

Read all instructions thoroughly before using the pre-filled syringe.

DO NOT use the pre-filled syringe if the needle cover has been removed.

How do you use the Prolia pre-filled syringe?

Your doctor has prescribed a Prolia pre-filled syringe for injection into the tissue just under the skin (subcutaneous). You must inject the entire content (1 mL) of the Prolia pre-filled syringe and it should be injected once every 6 months as instructed by your doctor.

Equipment:

To give an injection, you will need:

1. A new Prolia pre-filled syringe
2. Alcohol wipes or similar.

What to do before you give a subcutaneous injection of Prolia

1. Remove the pre-filled syringe from the refrigerator.
DO NOT pick up the pre-filled syringe by the plunger or needle cover. This could damage the device.
2. The pre-filled syringe may be left outside the refrigerator to reach room temperature. This will make the injection more comfortable.
DO NOT warm it in any other way, for example, in a microwave or in hot water.
DO NOT leave the syringe exposed to direct sunlight.
3. **DO NOT** shake the pre-filled syringe.
4. **DO NOT** remove the needle cover from the pre-filled syringe until you are ready to inject.
5. Check the expiry date on the pre-filled syringe label (EXP).
DO NOT use it if the date has passed the last day of the month shown.
6. Check the appearance of Prolia. It must be a clear, colourless to slightly yellow solution. The solution should not be injected if it contains particles or if it is discoloured or cloudy.
7. Find a comfortable, well-lit, clean surface and put all the equipment within reach.
8. Wash your hands thoroughly.

Where should you give the injection?

The best places to inject are the top of your thighs and the abdomen.

Your carer can also use the outer area of your upper arms.

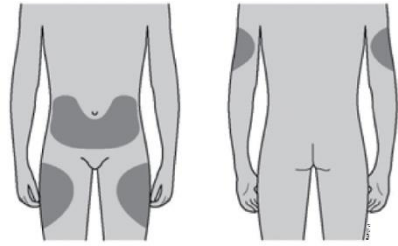

How do you give the injection?

1. Disinfect the skin by using an alcohol wipe.
2. To avoid bending the needle, gently pull the cover from the needle straight off without twisting, as shown in pictures 1 and 2. **DO NOT** touch the needle or push the plunger.

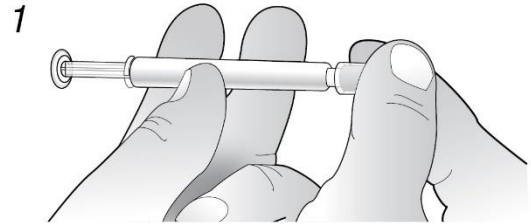

3. You may notice a small air bubble in the pre-filled syringe. You do not have to remove the air bubble before injecting. Injecting the solution with the air bubble is harmless.

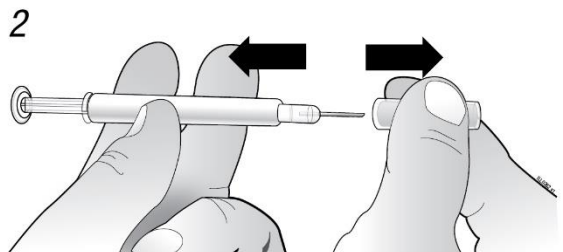

4. Pinch (without squeezing) the skin between your thumb and forefinger. Put the needle fully into the skin as shown by your doctor or healthcare provider.

5. Push the plunger with a **slow** constant pressure, always keeping the skin pinched. Push the plunger all the way down as far as it will go to inject **all the solution**.

6. Remove the needle and let go of the skin.

7. If you notice a spot of blood you may gently dab it away with a cotton ball or tissue. Do not rub the injection site. If needed, you may cover the injection site with a plaster.

8. Only use each pre-filled syringe for one injection. **DO NOT** use any Prolia that is left in the syringe.

Remember: if you have any problems, please ask your doctor or healthcare provider for help and advice.

Disposing of used syringes

- **DO NOT** put the cover back on used needles.
- Keep used syringes out of the reach and sight of children.
- The used syringe should be disposed of in accordance with local requirements. Ask your pharmacist how to dispose of medicines no longer required. These measures will help to protect the environment.