

6 July 2017  
EMA/51938/2013 Rev 1\*

## EU Individual Case Safety Report (ICSR)<sup>1</sup> Implementation Guide

Start of Public Consultation of first version	30 April 2014
End of Public Consultation of first version	30 June 2014
Final draft of first version agreed by Project Team 1	10 October 2014
Final draft of first version agreed by Project Coordination Group	19 November 2014
Final draft of first version endorsed by European Risk Management Strategy – Facilitation Group	27 November 2014
First version adopted by Pharmacovigilance Risk Assessment Committee (PRAC)	4 December 2014
Revision agreed by the “Pharmacovigilance Business Team” of the EMA/Member States governance structure for pharmacovigilance	30 June 2017
Revision submitted to EudraVigilance Expert Working Group for information	30 June 2017
Revision submitted to CT Regulation Safety Reporting project – subgroup H for information	06 July 2017
Revision submitted to Clinical Trials Facilitation group (CTFG) for information	06 July 2017
Revision submitted to Pharmacovigilance Risk Assessment Committee (PRAC) for information	06 July 2017
Revision submitted to EU Pharmacovigilance Oversight Group for information	06 July 2017
Revision submitted to IT Directors for information	06 July 2017

<sup>1</sup> EN ISO 27953-2:2011 Health Informatics, Individual case safety reports (ICSRs) in pharmacovigilance — Part 2: Human pharmaceutical reporting requirements for ICSR (ISO 27953-2:2011) and the ICH E2B(R3) Implementation Guide

**See websites for contact details**

European Medicines Agency [www.ema.europa.eu](http://www.ema.europa.eu)  
Heads of Medicines Agencies [www.hma.eu](http://www.hma.eu)

The European Medicines Agency is  
an agency of the European Union



\* Revision 1 contains the following updates:

- I.C.3.3 Attachments – Media types amendment to add open office spreadsheet (XSLX);
- I.C.3.6.3 Device Component –Figure 19, code snippet updated to match EU ICSR reference message instance;
- I.C.2.1.2 Recording and storage of Safety and Acknowledgement Messages amended;
- I.C.2.2 Retransmission of ICSRs from EudraVigilance to national Competent Authorities – requirement for acknowledgements to be returned clarified;
- I.C.2.2.2 Retransmission rules for suspected unexpected serious adverse reactions (SUSARs) from clinical trials defined in further details;
- I.C.3.1 Message Header – Figure 8 XML snippet updated to match EU ICSR reference message instance;
- I.C.6.2.1 Classification of medicinal products in the interim period before ISO IDMP is available – Section added;
- I.C.3.6.1.1 Use of Unified Code for Units of Measure (UCUM) section added;
- I.C.4.1 Business Rule Notes –additional notes added.

## Table of contents

<b>I.A. Introduction</b>	<b>6</b>
<b>I.B. Structures and processes</b>	<b>7</b>
<b>I.B.1. ICH E2B(R3) Implementation Guide and the International ICSR standard ISO/HL7 27953-2:2011</b>	<b>7</b>
<b>I.B.2 Data Quality Principles of Individual Case Safety Reports Transmitted Electronically</b>	<b>8</b>
<b>I.B.3 General ICH Safety Message Flow</b>	<b>9</b>
<b>I.C. Operation of the EU network</b>	<b>10</b>
<b>I.C.1. EU Implementation of ICH E2B(R3)</b>	<b>10</b>
<b>I.C.2. ICH Safety Message Flow in the EU</b>	<b>10</b>
I.C.2.1 Electronic Data Interchange	10
I.C.2.1.1 Security of Safety and Acknowledgement Messages	10
I.C.2.1.2 Recording and storage of Safety and Acknowledgement Messages: Confidentiality and Protection of Data	12
I.C.2.1.3 Operational Equipment and Services provided by the EMA to interested EDI Partners	12
I.C.2.1.3.1 WEB Trader	13
I.C.2.1.3.2 EVWEB	13
I.C.2.1.3.3 EVPOST Function	13
I.C.2.1.4 Registration Process	13
I.C.2.1.5 System testing requirements	14
I.C.2.1.5.1 Communication and validation testing	14
I.C.2.1.5.2 Gateway Configuration and communication testing	15
I.C.2.1.5.3 XML E2B testing phase	15
I.C.2.1.6 What to do in case of system failure	16
I.C.2.1.6.1 Failure of Safety Message generation	16
I.C.2.1.6.2 Failure of message transmission by the senders Gateway	17
I.C.2.1.6.3 Failure of message receipt by the Gateway at the level of the EMA	17
I.C.2.1.6.4 Failure of message processing by the EudraVigilance system	18
I.C.2.1.6.5 Failure of the EudraVigilance Web application	18
I.C.2.1.7 XML conformance	18
I.C.2.1.8 Processing and Acknowledgement of Receipt of Safety Messages	19
I.C.2.2 Retransmission of ICSRs from EudraVigilance to National Competent Authorities	24
I.C.2.2.1 Retransmission rules for post-authorisation E2B(R3) ICSRs	24
I.C.2.2.2 Retransmission rules for Clinical Trial SUSARs	26
I.C.2.3 Transmission of ICSRs entered into EudraVigilance by the EMA	29
I.C.2.4 Transmission of ICSRs classified in EudraVigilance by the EMA	30
<b>I.C.3 ICH Safety Messages and Individual Case Safety Reports (ICSRs)</b>	<b>31</b>
I.C.3.1 Message Header	31
I.C.3.1.1 Message Type	32
I.C.3.1.2 EudraVigilance Message Receiver Identifiers	33

I.C.3.2 Individual Case Safety Report (ICSR) .....	33
I.C.3.3 Attachments .....	34
I.C.3.4 Use of local Language in Reaction/Event section and Case Summary section .....	36
I.C.3.5 EU Causality Assessment Reporting in ICSRs .....	36
I.C.3.5.1 Data elements for Causality Assessments .....	37
I.C.3.5.1.1 EU Source of Assessment (EU E2B(R3) G.k.9.i.2.r.1.EU.1) .....	38
I.C.3.5.1.2 EU Result of Assessment (EU E2B(R3) G.k.9.i.2.r.3.EU.1) .....	39
I.C.3.5.1.3 Causality Assessment Example .....	40
I.C.3.6 Additional ISO/HL7 ICSR Data Fields for EU Regional Implementation.....	40
I.C.3.6.1 Integration with ISO IDMP Standards.....	41
I.C.3.6.1.1 Use of UCUM units .....	41
I.C.3.6.1.2 Medicinal Product Identifier (MPID) .....	42
I.C.3.6.1.3 Pharmaceutical Product Identifier (PhPID).....	43
I.C.3.6.1.4 Product Name Parts .....	44
I.C.3.6.1.5 Substance/Specified Substance TermID .....	47
I.C.3.6.1.6 Decision flow diagram for entering Medicinal Product Information .....	48
I.C.3.6.2 Biological Products requiring Batch Number .....	48
I.C.3.6.3 Device Component .....	49
I.C.3.7 Usage of nullflavor flags.....	51
I.C.3.8 Characterisation of Drug Role "Drug Not Administered" .....	53
I.C.3.9 Literature references and the use of Digital Object Identifiers (DOI) .....	53
I.C.3.10 MedDRA Version control .....	54
<b>I.C.4 Business Rules for E2B(R3) Message Processing .....</b>	<b>55</b>
I.C.4.1 Business Rule Notes .....	80
<b>I.C.5 The ICH Acknowledgment Message .....</b>	<b>83</b>
I.C.5.1 Acknowledgment Message Elements .....	84
I.C.5.2 Parsing error message .....	84
I.C.5.2.1 ICSR Message Cardinality checks.....	84
I.C.5.3 ICSR Message Acknowledgment Elements .....	84
I.C.5.4 Error/Warning message comments .....	84
I.C.5.4.1 Error / Warning Message or Comment (ACK.B.r.7) .....	85
I.C.5.4.1 Field Level error description list.....	87
I.C.5.4.2 Field Pair Error description list.....	89
I.C.5.4.3 Section Level Error description list .....	90
<b>I.C.6 ICSR Classification .....</b>	<b>90</b>
I.C.6.1 Classification algorithm .....	91
I.C.6.1.1 Nullification Reports.....	92
I.C.6.1.2 Master Cases .....	92
I.C.6.1.3 Case clustering .....	92
I.C.6.2 Classification of Medicinal Product Information.....	93
I.C.6.2.1 Classification of medicinal products in the interim period before ISO IDMP is available.....	94

<b>I.D Appendix .....</b>	<b>95</b>
<b>I.D.1 Electronic Data Interchange Definitions .....</b>	<b>95</b>
<b>I.D.2 Schema of ICSR Report Transactions using Gateway.....</b>	<b>99</b>
<b>I.D.3 Schema of ICSR Report Transactions using WebTrader .....</b>	<b>100</b>
<b>I.D.4 Rerouting of ICH E2B(R2) Messages.....</b>	<b>101</b>
I.D.4.1 Rerouting timeframes for ICH E2B(R2) Messages .....	101
I.D.4.1.2 Retransmission rules for Clinical Trial E2B(R2) SUSARs .....	102
I.D.4.1.3 Transmission of E2B(R2) ICSRs entered into EudraVigilance by the EMA .....	103

## I.A. Introduction

Regulation (EC) No 726/2004, Directive 2001/83/EC as amended and Directive 2001/20/EC outline the electronic reporting requirements to EudraVigilance, the data processing network and management system for reporting and evaluating suspected adverse reactions during the development and following the marketing authorisation of medicinal products in the European Economic Area (EEA). This guidance specifies the technical requirements and the process of transmission of Individual Case Safety Reports (ICSRs) and is applicable to all stakeholders, which are exchanging ICSR electronically within the EEA.

EudraVigilance was developed by the Agency in full compliance with the specifications of the International Council on Harmonisation of Technical Requirements for Registration of Pharmaceuticals for Human Use (ICH):

- ICH E2B(R2) 'Maintenance of the ICH guideline on clinical safety data management: data elements for transmission of Individual Case Safety Reports; ICH M2 standard 'Electronic Transmission of Individual Case Safety Reports Message Specification'.

To make these ICH standards and the electronic case reporting more useful and compliant with changing pharmacovigilance practices, a new version referred to as ICH E2B(R3) has been finalized in July 2013. ICH agreed to use the International Organization for Standardization (ISO) Individual Case Safety Report (ICSR) standard ISO EN 27953-2 to meet the reporting requirements for E2B(R3):

EN ISO 27953-2:2011 Health Informatics, Individual case safety reports (ICSRs) in pharmacovigilance — Part 2: Human pharmaceutical reporting requirements for ICSR (ISO 27953-2:2011).

Chapter IV of the Commission Implementing Regulation (EU) No 520/2012 refers to the possibility of organisations to use this ISO ICSR standard from 1st July 2016 onwards [IR Art 26].

ICH defines the way that this ISO ICSR standard should be used by means of the ICH E2B(R3) Implementation Guide which covers the use of the fields defined by E2B(R3). The ISO standard itself does contain additional data elements or requirements that are not used by ICH but may be used by specific regions. This guidance describes the additional EU specific requirements to generate a valid ICSR (also referred to as Safety Message) and Message Acknowledgment to implement EN ISO ICSR 27953-2:2011 in accordance with ICH E2B(R3). This guidance should be read in conjunction with the ICH E2B(R3) Implementation Guide and related materials published on the ICH website.

This guidance also specifies the technical requirements and the process of transmission of Safety and Acknowledgement Messages through the EudraVigilance Gateway and describes the obligations that stakeholders have to adhere to in this process to assure a successful electronic communication. The Electronic Data Interchange (EDI) process is based on the electronic exchange of a Safety Message between a Sender and a Receiver. The Acknowledgement Message confirms the receipt and the outcome of the validation of a Safety Message and completes the EDI process.

Technical tools have been made available by the Agency to interested electronic data interchange partners, including small and medium-sized enterprises, to facilitate compliance with the electronic reporting requirements as defined in EU legislation (more information is available on the EudraVigilance website). Responsibilities in case of communication failure (including adherence to compliance for reporting) are also described in this guidance.

The focus of this guidance is on technical implementation. Detailed reporting requirements are out of scope of this guidance document; these are described in Volume 10 of the Rules Governing Medicinal Products in the European Union and in Guideline on good pharmacovigilance practices (GVP) Module VI – Management and reporting of adverse reactions to medicinal products.

## I.B. Structures and processes

ICSRs shall be used for reporting to the EudraVigilance database suspected adverse reactions to a medicinal product that occur in a single patient at a specific point in time [IR Art 27]. Taking into account the international dimension of adverse reactions reporting and the need to achieve harmonisation and high quality between all involved parties, ICSRs should be submitted electronically as structured data with the use of controlled vocabularies for the relevant data elements where applicable. The formats, standards and terminologies for the electronic transmission of suspected adverse reactions as referred to in Chapter IV of the Commission Implementing Regulation (EU) No 520/2012 shall be used.

ICSRs reported electronically to the EudraVigilance database will be made accessible to stakeholders such as competent authorities, healthcare professionals, consumers, as well as marketing authorisation holders and research organisations in accordance with Article 24(2) of Regulation (EC) No 726/2004 and the EudraVigilance access policy<sup>2</sup>. This policy defines the overall principles of the provision of access to EudraVigilance data in line with the current legal framework, while guaranteeing personal data protection.

Two modules are available in the EudraVigilance database to address the collection of reports of suspected adverse reactions related to medicinal products for human use, in accordance with EU legislation:

1. The EudraVigilance Post-Authorisation Module (EVPM): related to ICSRs which need to be reported according to Regulation (EC) No. 726/2004 and Directive 2001/83/EC as amended. The ICSRs received in this module will be referred to in this document as EVPM-ICSRs (EudraVigilance Post-authorisation Module Individual Case Safety Reports).
2. The EudraVigilance Clinical Trial Module (EVCTM): related to ICSRs which need to be reported in accordance with Directive 2001/20/EC and Volume 10 of the Rules Governing Medicinal Products in the European Union. The Safety Messages sent to this module contain reports from interventional clinical trials only, as defined in Article 2(a) of Directive 2001/20/EC. The ICSRs received in this module will be referred to in this document as EVCT-ICSRs (EudraVigilance Clinical Trial Individual Case Safety Reports).

The reporting of valid ICSRs electronically, by competent authorities in Member States and marketing authorisation holders, is mandatory for all medicinal products authorised in the EU [DIR Art 107(3), Art 107a(4)]. Non-adherence to this requirement constitutes a non-compliance with EU legislation. Responsibilities in case of communication failure (including adherence to compliance for reporting) are detailed in Section I.C.2.1.6.

### I.B.1. ICH E2B(R3) Implementation Guide and the International ICSR standard ISO/HL7 27953-2:2011

The ICH Implementation Guide is a consensus document that describes a unified approach from the six ICH parties and the related observers. ICH strives to achieve harmonisation in the interpretation and application of technical guidelines and requirements for pharmaceutical products, including those related to safety reporting and pharmacovigilance. However, in practice, legislation and national or regional differences in clinical practice, in health prioritisation, and in attitudes towards privacy and towards characterisation or categorisation of individuals all lead to differing requirements in certain

---

<sup>2</sup> European Medicines Agency policy on access to EudraVigilance data for medicinal products for human use (EMA/759287/2009)

aspects of safety monitoring. Legislation may require information in one region that is inappropriate to share or transmit in another region. Differing attitudes and priorities may require information in one region that is of not of interest in another region, or would not normally be collected.

The ICH Implementation Guide has identified data elements that will vary in usage across the ICH regions. For these data-elements, where appropriate, EU specific guidance is provided in this document. The ISO ICSR standard itself contains a broad set of technical tools (elements and approaches) to capture information that may not be used by ICH as part of the core, harmonised ICSR but may be used only by specific regions. This document describes the use of EU specific data-elements that are not part of the ICH core ICSR. Also, this guidance provides the validation rules specific for EU.

This guidance should not be used as a stand-alone document when creating ICSRs, but should be read in conjunction with the ICH E2B(R3) Implementation Guide and related materials published on the ICH website.

## **I.B.2 Data Quality Principles of Individual Case Safety Reports Transmitted Electronically**

The EudraVigilance database should contain all cases of suspected adverse reactions that are reportable according to Directive 2001/83/EC and Regulation (EC) No 726/2004. The EudraVigilance database should also be based on the highest internationally recognised data quality standards. To achieve these objectives, all stakeholders should adhere to:

- The electronic reporting requirements as defined in EU legislation;
- The concepts of data structuring, coding and reporting in line with the EU legislation, guidelines, standards and principles.

This is a pre-requisite to maintain a properly functioning EudraVigilance database intended to fully support the protection of public health.

The Agency shall, in collaboration with the stakeholder that submitted an ICSR to the EudraVigilance database, be responsible for operating procedures that ensure the highest quality and full integrity of the information collected in the EudraVigilance database [REG Art 24(3)]. This includes as well the monitoring of use of the terminologies referred to in Chapter IV of the Commission Implementing Regulation (EU) No 520/2012 [IR Art 25(3)].

Specific quality system procedures and processes shall be in place in order to ensure:

- The submission of accurate and verifiable data on serious and non-serious suspected adverse reactions to the EudraVigilance database within the 15 or 90-day time frame [IR Art 11 (1) (c)],
- The quality, integrity and completeness of the information submitted on the risks of medicinal products, including processes to avoid duplicate submissions [IR Art 11 (1) (d)].

In this regard, marketing authorisation holders and competent authorities in Member States should have in place a quality system, which ensures the highest quality of the ICSRs transmitted electronically to the EudraVigilance database within the correct time frames, and which enables the detection and management of duplicate ICSRs in their system.

A review of the ICSRs quality, integrity and compliance with the reporting time frames will be performed by the Agency at regular intervals for all organisations reporting to the EudraVigilance database. Feedback from these reviews will be provided to those organisations. High level business process maps and process descriptions in relation to the quality review of ICSRs and the detection and management of duplicate ICSRs are provided in Good Vigilance Practice Module VI Appendix 6 and VI



Appendix 7. Further guidance on the detection of duplicate ICSRs is available in the Guideline on the Detection and Management of Duplicate Individual Cases and Individual Case Safety Reports (ICSRs), EMA/13432/2009.

Competent authorities in Member States and marketing authorisation holders should ensure that all reported electronic ICSRs are well documented and as complete as possible in accordance with the requirements provided in [IR Art 28]. It is recognised that it is often difficult to obtain all the details on a specific case. However, the complete information (medical and administrative data) for a valid ICSR<sup>3</sup> available to the sender should be reported in a structured manner in the relevant ICH-E2B(R3) data elements (which should be repeated as necessary when multiple information is available) and in accordance with requirements specified in Module VI – Management and reporting of adverse reactions to medicinal products or in Volume 10 of the Rules Governing Medicinal Products in the European Union. This applies to all types of ICSRs, such as reports with initial information on the case, follow-up information and cases highlighted for nullification/amendment.

### I.B.3 General ICH Safety Message Flow

The process of exchange of ICH safety messages starts with the reporter of the ICSR in this context they act as an informer of the ICSR. The informer will provide the data to a concerned organisation or person. This concerned party will often have legal obligations to exchange that information with other parties. In most situations the ICSR informer will not provide this information in the ICH E2B(R3) format. The organisation or person receiving this information will then be responsible to create an ICH E2B(R3) message according to regional requirements and submit the message on to appropriate receivers. These primary receivers may also be required to forward on ICSRs to other parties; however the reports should only have minor administrative changes made so that the information as captured from the original source is maintained.

The diagram below summarises the safety message flow from an ICH perspective, further details of the process can be seen in section I.C.2.1.8 .

**Figure 1 – ICH safety message flow**

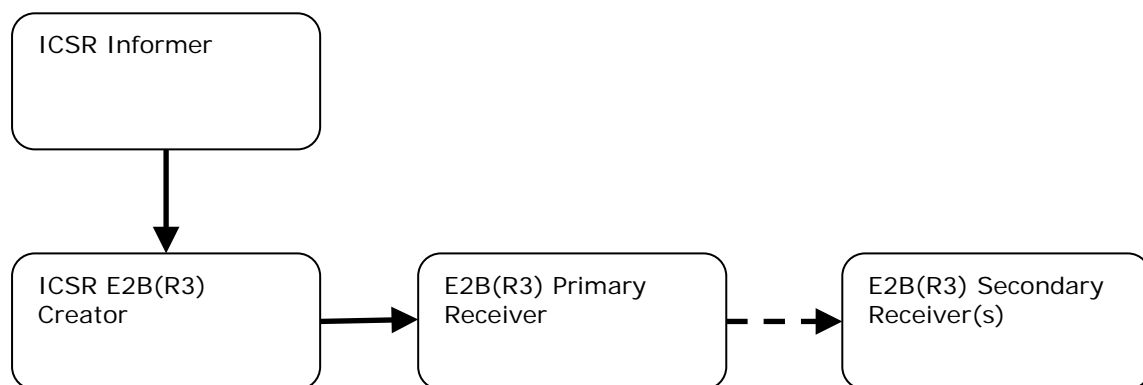

<sup>3</sup> Valid reports are defined in [GVP VI.B.2. Validation of reports](#)

## **I.C. Operation of the EU network**

### **I.C.1. EU Implementation of ICH E2B(R3)**

The ICH E2B(R3) Implementation guide was developed through international harmonisation using a consensus approach. The majority of the requirements of the three ICH regions were able to be incorporated in to the ICH E2B(R3) IG however some additional requirements due to differences in regional legislation could not be covered. The ICH E2B(R3) IG makes provisions for this fact and it is expected that each ICH region will produce its own regional IG based on the core set of the ICH document. The intention is that each region's IG will not conflict with each other. The ICH E2B(R3) IWG is tasked with reviewing the regional implementation guides to ensure there is no conflict between the regional implementations, the ICH group will also produce an additional Question and Answers document to help implementers of the standard.

This document sets out the specific requirements that are required in the EU for the electronic exchange of ICSRs and is therefore an extension to the ICH E2B(R3) IG.

### **I.C.2. ICH Safety Message Flow in the EU**

#### ***I.C.2.1 Electronic Data Interchange***

This section describes the procedures concerning the Electronic Data Interchange (EDI) of Individual Case Safety Reports (ICSRs) in pharmacovigilance in the pre- and post-authorisation phase and the roles of all involved stakeholders in the EEA i.e. the Competent Authorities (CAs), the Marketing Authorisation Holders (MAHs), Applicants and Sponsors of clinical trials.

It also describes the operational requirements and agreed standards for EDI and the secure exchange of Safety and Acknowledgement Messages.

In addition this section specifies the technical requirements and the process of transmission of electronic reports and messages through the EudraVigilance Gateway established at the EMA and describes the obligations that EDI partners have to adhere to in this process to assure successful electronic communication.

The implications of electronic reporting with regard to the legal reporting compliance as defined in EU legislation, the evaluation steps and the recovery procedures in the event of a communication failure are also described.

The definitions of the terms used in this document are provided in I.D.1 *Electronic Data Interchange Definitions*. An overview of the process of EDI exchange is provided in I.D.2 *Schema of ICSR Report Transactions using Gateway* and I.D.3 *Schema of ICSR Report Transactions using WebTrader*.

#### **I.C.2.1.1 Security of Safety and Acknowledgement Messages**

To facilitate the secure transmission of Safety and Acknowledgement Messages over the Internet, each party should implement and maintain security procedures and measures in order to ensure the protection of Safety and Acknowledgement Messages against the risks of unauthorised access, disclosure, alteration, delay, destruction or loss, ensuring the verification of integrity, the non-repudiation of origin and receipt and ensuring the confidentiality of the Safety and Acknowledgement Message. This includes the installation and operation of applications that allow for the successful transmission and receipt of encrypted and digitally signed Safety and Acknowledgement Messages via the EudraVigilance Gateway, or the use of service providers for this purpose. The software or service

necessary to create, transmit, receive, translate, record and store Safety, Acknowledgement and MDN messages should be in full compliance with the specifications provided in this document.

The Gateway uses a combination of public/private key encryption, which is also known as asymmetric encryption and symmetric key encryption. The Gateway supports RC2, RC4, DES (Data Encryption Standard) and Triple DES encryption algorithms. Only X.509 certificates are accepted.

For the exchange of Safety and Acknowledgement Messages the EDI partners are operating in a Closed User Group i.e. the parties are known to each other. As a consequence, the parties agree to use the RSA cryptosystem for asymmetric encryption and the digital signatures provided by using certificates. Two types of RSA keys will be accepted:

- Keys issued by a certification authority i.e. managed keys.
- Keys generated by the party individually i.e. self-signed keys.

The following table specifies the algorithm and key lengths for symmetric and asymmetric keys acceptable to the EMA:

- Symmetric algorithm for document encryption
  - Triple DES 168 bits
- Asymmetric algorithm for authentication
  - RSA 1024 or 2048 bits

Dual keys are also supported.

Before encrypted and signed Safety and Acknowledgement Messages can be exchanged each party must obtain the other's public key. This will be done after each party has created its Gateway profile. Each party generates a self-signed certificate or obtains one from a certification authority. Either way, the process must result in the creation of a public/private key pair for each party. The private half of this key always remains with the party, the public half is provided to the other party.

In order for each party to be connected to the Gateway, profile information must be exchanged between the EDI Partner and the EMA. The following items are required for the proper creation of the EDI Partner's profile on the Gateway:

- Organisation Name
- Complete Address (Street, City, State, Post Code, Country)
- Gateway Contact Name
- Gateway Contact E-Mail Address
- Gateway Contact Phone Number
- Gateway E-Mail Address for receiving transmissions (if using AS1)

The corresponding EMA-EudraVigilance information will then be supplied to the EDI Partner.

There are 2 different scenarios for the exchange of this information.

- Gateway self-registration if using a product supporting such functions
- Manual exchange of the above information via E-Mail with the addition of the EDI Partner's public encryption certificate

A new certificate must be generated or obtained by each party when

- It becomes evident or it is suspected that a certificate has been compromised
- A certificate needs to be replaced because it expires
- The encryption key is changed at planned intervals

If the use of the above security procedures and measures result in the rejection of or in the detection of an error in, a Safety or Acknowledgement Message(s) transmission, the Receiver should inform the Sender thereof, within two business days. The Sender should initiate an alternative recovery procedure following the instructions of the EMA and resubmit the Safety or Acknowledgement Message(s) until successful completion of this process as outlined in section I.C.2..

### **I.C.2.1.2 Recording and storage of Safety and Acknowledgement Messages: Confidentiality and Protection of Data**

All Safety and Acknowledgement Messages should be stored and treated in the same way as other medical documents with appropriate respect for confidentiality. The EDI Message being a Safety or Acknowledgement Message, sent or received should, for the security of the Transaction, be stored completely in a secure way and without alteration.

The data transferred between EDI partners should be stored in the format in which it was sent or received. This data as submitted will constitute, if necessary evidence of the EDI Message (Safety or Acknowledgment Message) as it has been originally sent or received, without any alteration of the message.

Data should be stored by the Receiver in a dedicated pharmacovigilance information system in accordance with requirements detailed in GVP modules I and VI. It should be ensured that readability of historic EDI messages is maintained. Conformity of stored data with the initial ICSR, if not received electronically, should be ensured by a quality control procedure, which provides for validation against the original data.

Storage should ensure traceability (audit trail) of all data entered or modified, including dates and sources of received data, dates and destinations of transmitted data.

Each party should safeguard electronic data from tampering and unauthorised disclosure to ensure, at a minimum, to the same level of protection as required for their paper equivalents.

This protection must be extended beyond the Transactions to any files or databases that contain information conveyed via EDI. Each party must ensure and provide the security to maintain the confidentiality of the information. When applicable, both parties must also maintain the confidentiality of passwords and other codes required for accessing this information.

It is the responsibility of each party to maintain their own archive of individual Transactions in a format acceptable to themselves.

Furthermore, any services performed by any intermediary in respect of such confidential information should likewise be subject to the same degree of confidentiality.

Directive 95/46/EC of the European Parliament and of the Council of 24 October 1995 on the protection of individuals with regard to the processing of personal data and on the free movement of such data (Official Journal L 281, 23/11/1995 P. 0031 – 0050) apply accordingly.

### **I.C.2.1.3 Operational Equipment and Services provided by the EMA to interested EDI Partners**

The services that EMA is providing in relation to EudraVigilance will be supported and made available during normal business hours of personnel at the EMA which are from 9am to 5pm UK time Monday through Friday, excluding public holidays observed by the EMA. These systems will also normally be available 24 hours per day and 7 days per week. However, no guarantees of availability or support are

provided outside of business hours. Planned non-availability of these services during and outside of business hours will be communicated to all registered users of the system.

#### ***I.C.2.1.3.1 WEB Trader***

The WEB Trader is an integrated component of EVWEB online tool. It provides an alternative solution to the use of a local Gateway to support the electronic transmission of Safety and Acknowledgement messages. The Web Trader allows registered EDI Partners to exchange EDI Messages with the EudraVigilance database. The Web Trader is only available to EDI Partners, which are not registered as Gateway users in EudraVigilance i.e. organisations that do not have a local Gateway established to support the EDI process in pharmacovigilance.

#### ***I.C.2.1.3.2 EVWEB***

The EMA provides to interested EDI Partners a web based reporting tool, EVWEB.

EVWEB allows registered EDI Partners to:

- Generate fully ICH E2B(R3) compliant Safety and Acknowledgement Messages and to electronically transmit these messages in secure way via the Gateway to the EudraVigilance database.
- Access EVWEB for query purposes taking into account the access policies agreed at EU level.

EVWEB will also provide access to internationally agreed standard terminology such as MedDRA. EDI Partners will be solely responsible for any license fees that may result from the use of MedDRA within this web based reporting tool provided by the EMA.

A Safety Message can be considered successfully transmitted by the Sender when, after pressing the 'Send' button, the pop up window in EVWEB displays the notice 'Message sent successfully'. The Sender can confirm the successful transmission by checking the presence of the sent Safety Message in the WEB Trader Outbox section of EVWEB. The Sender should check the WEB Trader Inbox on a regular basis to obtain the acknowledgment message that confirms successful receipt and processing by the receiver of the safety message.

In addition EVWEB contains tracking functions that enable the EDI Partner registered as WEB Trader to view the date of the transmission of all EDI Messages that have been sent and received.

#### ***I.C.2.1.3.3 EVPOST Function***

As part of EVWEB the EMA provides to interested EDI Partners the possibility to transmit XML E2B(R3) files created by the EDI partner's pharmacovigilance system without having a local gateway connection. Through the EudraVigilance website WEB Trader organisations can upload their files using the EVPOST function.

The message flow using the WEB Trader is outlined in Appendix I.D.3.

In addition EVWEB contains tracking functions that enable the EDI Partner registered as WEB Trader to view the date of the transmission of all EDI Messages that have been sent and received.

As a general principle, the responsibility for the use of EVWEB and the WEB Trader lies solely with the EDI Partner that subscribes to these services with the EMA.

#### ***I.C.2.1.4 Registration Process***

The registration with EudraVigilance is necessary to identify and manage organisations in the European Economic Area (EEA) for the electronic reporting of suspected adverse reactions and the electronic

submission of information on medicines. This is to ensure that proper privacy and security measures are in place and that the principles of data integrity, accountability and availability are adhered to.

Only registered organisations are permitted to exchange Safety and Acknowledgement Messages by means of the Gateway. A list of registered organisations, which are part of the EudraVigilance user community is maintained by the Agency and is accessible for all registered partners in the restricted area of the EudraVigilance website. The ID profile and the description of the registered organisation is available in OMS.

Details and instructions for the registration process with EudraVigilance are available on the EudraVigilance website.

## **I.C.2.1.5 System testing requirements**

### ***I.C.2.1.5.1 Communication and validation testing***

To assure the successful operation of EDI, each new EDI partner who wishes to transmit Safety Messages electronically will undergo a staged test procedure, which includes the following phases:

1. **Communication test** to assure successful Gateway to Gateway communication. The successful completion of the communication testing between the EMA and the EDI Partner will be certified by the EMA so that the EDI Partner can move into the subsequent stages of testing.

The process of establishing the connection requires several steps.

- Document Transport Choice
- Exchange of Profile Information
- Exchange of Public keys for encryption
- Testing the Connection

When a successful connection has been established Safety and Acknowledgement Messages can be successfully transferred between each party in the programme. This is accomplished by sending an encrypted Safety or Acknowledgement Message to the Gateway, where it is unencrypted, checked for basic accuracy, then re-encrypted and sent to the ultimate destination. A list of registered parties will be maintained and distributed by the EMA. Safety and Acknowledgement Message exchange can only take place between registered parties.

2. **Development and validation** testing of EDI partners with the EudraVigilance test environment at the discretion of the EDI Partner. Once the EDI Partner has completed this test phase they will notify EMA to move into the XML test phase. Step 2 of the testing is applicable for the testing of all EDI Partners with the EMA.
3. **XML test phase** with the submission of sample test cases to the EudraVigilance test environment, compliant with the requested specifications: syntax, field lengths, minimum information and data coding against ICH E2B(R3) and standard terminology. The successful completion of the testing between the EMA and the EDI Partner will be certified by the EMA so that the EDI Partner can move into production.
4. **Production phase** the EDI Partners acknowledge the validity of E2B(R3) Safety or Acknowledgement Messages.

Any technical changes must be communicated immediately in writing between the EDI Partners. Major technical changes may require the re-initiation of both test phases as described above. Organisations should not submit E2B(R3) messages to the production EudraVigilance system until they have completed the testing and have been approved for step 4 production phase as described above.

Organisations do not need to repeat the step 1 communication test if the gateway connection has previously been tested for E2B(R2) submissions.

Organisations using EVPOST function as described in section I.C.2.1.3.3 need to perform the XML test phase but do not need to perform the communication test.

Organisations using the EVWEB application as described in section I.C.2.1.3.2 do not need to perform any system testing described in this section.

#### ***I.C.2.1.5.2 Gateway Configuration and communication testing***

This section describes the computer software and communication standards used by the Gateway. Senders will be required to adopt hardware, software and data communication configurations to meet these standards, which are based on the recommendations of ICH.

The Sender's EDI system must comply with the following standards for the EudraVigilance Gateway certification:

- S/MIME compatible email system using POP/SMTP (AS1), direct connection via HTTP (AS2)
- Support for digitally signed MDNs
- X.509 digital certificate support
- EDIINT/AS1 compliance certification or AS2 interoperability
- Direct transmittal of XML documents

The EMA does not mandate any particular product for the EDI communication. If the Sender's product adheres to the above standards and is fully interoperable with the Gateway at the EMA, then the Sender will receive certification from the EMA to use it. It is the direct responsibility of the Sender to conform to the EMA Gateway, as the Gateway is a certified interoperable product.

Communications via the Sender's and the Receiver's Gateway will take place over the Internet. The parties must comply with the full set of the ICH endorsed security standards.

Each EDI Partner is responsible for its own costs in obtaining and maintaining the services of Internet access from an Internet Service Provider (ISP).

EDI Partners are responsible for the preparation of Safety or Acknowledgement Messages in full compliance with the requirements detailed in this document

EDI Partners, at their own expense, should provide and maintain the necessary equipment, software, services and testing necessary to effectively and reliably create, transmit and manage valid Safety and Acknowledgement Messages.

#### ***I.C.2.1.5.3 XML E2B testing phase***

The EMA will provide a set of sample XML ISO ICSR files to be uploaded and transmitted to the EudraVigilance external testing system along with a testing script to be followed by the EDI partner. In addition for organisations that have not implemented importing functionality the data for submission will be made available in a human readable non-E2B(R3) format for manual data entry and submission. The set of sample files will cover a range of different reporting scenarios in order to ensure the correct implementation of ISO ICSR 27953-2:2011 in accordance with ICH E2B(R3) and the additional EU specific requirements detailed in this document.

The EDI partner is expected to upload these sample files into the pharmacovigilance system they are testing and follow the test script to produce some additional test files. Once uploaded these test files should be transmitted to the EudraVigilance external testing system for review by the EMA.

Unexpected differences between the sample set of ICSR files and the information received by the EudraVigilance external testing system will be communicated to the EDI partner as issues that need to be addressed before allowing the EDI partner into the production phase.

The sample files and scripts will include the following scenarios:

- Initial and follow-up
- Patient death
- Parent/child
- Past drug / past medical history / Test results
- Biological products
- Advanced therapies (device component)
- Product name parts
- Clinical trial SUSAR
- Patient support program
- Observational studies
- Literature report with article attached

Additional documents will be made available showing which fields in the ISO ICSR standard will be covered by each of these scenarios and provide further guidance on the testing process. If an organisation does not have the obligation to report certain types of safety message (e.g. Clinical Trial SUSARs) they are not required to test such types of report. However, if that organisations situation changes in the future and they are required to send reports for which they have not performed testing they will be required to complete the remaining test scenarios.

### **I.C.2.1.6 What to do in case of system failure**

Organisations should ensure that adequate business continuity processes and back-up systems are put in place to deal with system failures in line with the recommendations given in GVP Module I.B.11.3. *Critical pharmacovigilance processes and business continuity*. The intention should be to ensure that any system failures should be resolved within a short period of time to ensure that reporting compliance is maintained.

Due to the move to simplified electronic reporting of ADRs directly into the EudraVigilance database the submission of CIOMS I forms via fax or post to the EMA is no longer supported and therefore should not be included as an option in business continuity processes.

System failures can occur at either the sender's side or the receiver's side, details of what organisations should do in these situations are described in the sections below.

#### ***I.C.2.1.6.1 Failure of Safety Message generation***

In case of any mechanical, programme, electronic or communication failure, which prevents an EDI Partner from physically generating a Safety Message to send to another EDI Partner, the issue should be investigated quickly. If the issue with the system can be resolved without affecting the 7/15/90 day compliance the organisation should work on addressing the issue, no other actions are required at this stage.

If the issue cannot be resolved within a short timeframe that will lead to submissions missing their 7/15/90 day compliance the sending organisation should contact the receiving organisations to inform them of the issue. They should also include the expected timeframe for when the issue is expected to be addressed. When the sender's system has been fixed, the outstanding cases should be transmitted as quickly as possible.



This scenario also applies when a Safety Message concerning a valid case(s) which meet the minimum reporting requirements and can be physically generated and transmitted but where the Safety Message is acknowledged with a transmission acknowledgement code indicating that the Safety Message has been rejected in part or in total (transmission acknowledgement code "AE" or "AR").

#### ***1.C.2.1.6.2 Failure of message transmission by the senders Gateway***

In case of a gateway failure at the sender's side, if the organisation is able to generate valid Safety Message(s) these can be submitted via CD-ROM or DVD physical media, if the organisation has a Eudralink account this can also be used send files securely. If the sender is unable to generate valid safety report messages in such situations they should follow 1.C.2.1.6.1 *Failure of Safety Message generation*

Before initiating this procedure the EMA IT Service Desk (<http://servicedesk.ema.europa.eu/>), Tel. +44 (0)20 3660 7523 should be contacted to inform them of this issue including the expected timeframe for when the issue is expected to be addressed. The Acknowledgement Messages for the cases received on physical media will be returned via the EudraVigilance gateway. Since no ICSR-MDN will be generated in this process, the date of the Report Sender's record of sending the report on physical media will be sufficient to prove regulatory compliance.

#### ***1.C.2.1.6.3 Failure of message receipt by the Gateway at the level of the EMA***

In the event of prolonged unavailability of the Gateway including the EV-Post function, as confirmed by the EMA during EMA business hours as defined in 1.C.2.1.3, which could affect the sender's ability to meet regulatory reporting timeframes the Report Sender can either send the:

- ICH E2B(R3) or ICH E2B(R2) Safety Messages as valid XML files to the EMA via CD-ROM or DVD physical media (registered post is recommended). The date of the Sender's record of sending the physical media will be sufficient to prove regulatory compliance in an inspection of the Sender. Acknowledgments will be returned via the gateway once the gateway becomes available again.
- ICH E2B(R3) or ICH E2B(R2) Safety Messages to the EMA when the Gateway becomes available again. Reports that are submitted within 2 EMA business days of the gateway being made available again will have their reporting compliance calculated against the first day of system failure. The EMA will also provide the official dates of when the EudraVigilance gateway was unavailable.

Events/observations, which may affect the risk-benefit balance of a medicinal product during the period where EudraVigilance is unavailable, should be notified as emerging safety issues to EMA and national Competent Authorities in the EEA.

In addition, before starting the alternative transmission process, the steps indicated below should be followed:

- ***E-mail as Document Transport Choice to the Gateway***

If the Report Sender is using e-mail as the transport protocol (AS1) and has not received an MDN for a sent Safety or Acknowledgement Message in over six hours and no rejected Safety or Acknowledgement Message arrived at the Report Sender's Gateway, then there is a possibility that there is a mechanical, programme, electronic or communication failure at the Gateway of the EMA. In this case the Sender should immediately contact the EudraVigilance Helpdesk at the EMA.

- ***HTTP(S) as Document Transport Choice to the Gateway***

If the Report Sender is using HTTP or HTTPS as the transport protocol (AS2) and experiences connection errors, then the Report Sender should determine if the problem arises at the level of

the Sender's system, the Internet or the Gateway. In case the problem cannot be resolved by the Report Sender and this could affect the sender's ability to meet regulatory reporting timeframes, they can initiate alternative transmissions using physical media and if necessary contact the EMA IT Service Desk (<http://servicedesk.ema.europa.eu/>), Tel. +44 (0)20 3660 7523

#### ***1.C.2.1.6.4 Failure of message processing by the EudraVigilance system***

In case of a database or processing failure after receipt at the level of the EudraVigilance system, the Report Sender may continue to send electronic messages to the Gateway. This situation will result in the receipt of an ICSR-MDN but not of an Acknowledgement Message. The processing and Acknowledgement of Receipt procedures will be followed once the services at the EudraVigilance system are restored.

All reporting obligations are fulfilled in this scenario. The Report Sender may contact the EMA IT Service Desk (<http://servicedesk.ema.europa.eu/>), Tel. +44 (0)20 3660 7523 to inquire about the missing Acknowledgement Messages if they are not received within two business days. After resolving the failure, all Safety Messages will be processed and the Acknowledgement Messages returned through the EudraVigilance Gateway.

Once the services at the level of the EudraVigilance system are restored, the procedure that verifies the semantics, syntax, format and content both on the message and the report level will be operated again. The Acknowledgment Message will be generated which indicates acceptance or rejection of the received Safety Message(s).

The Report Sender of a Safety Message that has been rejected in part or in total (transmission acknowledgement code "AE" or "AR") has the obligation to resubmit corrected versions immediately upon receipt of the Acknowledgement Message.

#### ***1.C.2.1.6.5 Failure of the EudraVigilance Web application***

In the event of prolonged unavailability of the EudraVigilance Web application, as confirmed by the EMA, during EMA business hours as defined in I.C.2.1.3, which could affect the sender's ability to meet regulatory reporting timeframes the Report Sender should send the Safety Messages to the EMA when the EudraVigilance Web application becomes available again. These reports will be excluded from reporting compliance monitoring as long as they are submitted within 2 EMA business days of the EudraVigilance Web application becoming available again.

#### ***1.C.2.1.7 XML conformance***

There are two levels of conformance in the XML specifications: a Well-formed and a valid message.

1. A Well-formed message is an XML document that conforms to the structural rules of XML:
  - The first line should be the XML document declaration (see I.C.3.1 for details)
  - The document should contain at least one element (or tag)
  - Every starting tag should have a closing tag
  - <tag/> is also permitted for tags that do not contain data
  - Tags cannot overlap.

In order to improve the readability of the XML file, a carriage return should be inserted after each closing tag e.g. <start tag>Value</end tag> [CR][LF]. CR: carriage return, LF: line feed.

In addition, as XML is case sensitive, all the fields and attributes names have to be in correct case in order to comply with the XML schema.

2. A valid XML file is one which has a schema reference and which conforms to that schema. The schema is a document that defines the valid elements (tags), attributes and the order that they may appear in a particular type of XML document. It also defines some of the valid content of the XML elements and attributes. A valid XML file should also be well-formed.

Regarding all aspects of XML, the W3C standards should be followed as published at <http://www.w3.org/>

Further details on the schema reference and encoding for the XML files are provided in section I.C.3.1 *Message Header*

### **I.C.2.1.8 Processing and Acknowledgement of Receipt of Safety Messages**

The EudraVigilance system performs a basic validation of any incoming Safety Message against the specified XML schema. The sender is responsible for including the correct Safety Message XML header as specified in I.C.3.1. In case the sender has not included the correct schema reference in the XML header as indicated in I.C.3.1 the return of an Acknowledgment Message cannot be guaranteed.

In case of the detection of a parsing error by EudraVigilance, the following scenarios may occur:

- If during the parsing process of the Safety Message, EudraVigilance can detect a valid sender identifier, an Acknowledgement Message will be created and sent to the sender, listing the detected error. The Transmission Acknowledgement Code reported in the data element ACK.A.4 will be 'AR' i.e. no data extracted.
- If during the parsing process of the Safety Message, EudraVigilance cannot detect a valid sender identifier, an Acknowledgement Message cannot be created, as the sender cannot be identified. In this case no Acknowledgement Message will be returned. Senders of ICSRs should monitor for the lack of receipt of acknowledgment after waiting 2 business days and take further action as described in I.C.2.1.6 What to do in system failure.
- If the parsing process of the Safety Message is successful and EudraVigilance cannot detect a valid receiver identifier, an Acknowledgement Message will be created and sent to the sender, listing the detected error. The *Transmission Acknowledgement Code* reported in the data element ACK.A.4 will be 'AR' i.e. no data extracted.

If the Safety Message is valid according the Safety Message XML schema validation, EudraVigilance will perform the upload of the Safety Message with the Inbound Load Process.

The process flow is described in the flowchart in Figure 2 below, which should be read in association with this section.

For routine electronic reporting a Safety Message including one or several ICSRs is sent by the Report Sender in internationally agreed electronic format through an electronic Gateway to the Report Receiver, which for the purpose of this guideline is an EDI Partner as defined in I.D.1 *Electronic Interchange Definitions*. The electronic Gateway of the Report Sender encrypts the message and dispatches it through the Internet. The Report Receiver's Gateway automatically returns a MDN upon receipt of the message decrypts the message and forwards it to the Report Receiver's locally established pharmacovigilance system. This MDN will be subsequently referred to as the ICSR-MDN.

In the Report Receiver's locally established pharmacovigilance system the arriving Safety Message is processed following the Acknowledgement of Receipt procedure and a corresponding Acknowledgement Message (ICSRACK) is returned by the Report Receiver to the Report Sender. The ICSRACK will be transmitted from the Report Receiver's Gateway to the Report Sender's Gateway, which thereupon

automatically returns a MDN upon receipt of the Acknowledgement Message. This MDN will be subsequently referred to as the ICSRACK-MDN.

A Safety Message is successfully recognised and validated when:

- a. The Batch Sender Identifier ID (N.1.3) and the Batch Receiver Identifier (N.1.4) can be correctly identified in the Safety Message. The Sender ID and the Receiver ID must be registered EDI Partners of the Gateway. In addition the Batch Sender ID (N.1.3) provided must match the EDI gateway ID that was used to send the file
- b. The Safety Message is well-formed i.e. a valid XML file
- c. The Safety Message is in accordance with the ISO 27953-2:2011 ICSR XML schema
- d. The Safety Message and the Safety Reports are in full compliance with the business rules adopted at EU level (I.C.4 *Business rules*)

The EudraVigilance system will reject Safety Messages automatically, if they are not in accordance with point a), b) and c). As a result, it is the sole responsibility of the Sender to ensure that the above criteria are fully met so that the Safety Message can be recognised successfully by the EudraVigilance system.

A Safety Message is successfully transmitted, when the Report Sender receives an ICSR-MDN. The date of the ICSR-MDN will serve as the official receipt date of the transmission of the Safety Message by the Gateway and documents the fulfilment of the reporting timelines as defined in EU legislation.

The successful transmission, though fulfilling the requirements of receipt of an ICSR-MDN, does not indicate acceptance of the Safety Message by the Receiver's locally established pharmacovigilance system in the Acknowledgement of Receipt procedure.

In this procedure the Receiver verifies the semantics, syntax, format and content both on the message and the report level. The Acknowledgment Message, as defined by ICH E2B(R3) is generated as further detailed in section I.C.5 which indicates acceptance or rejection. A rejection in the Acknowledgement of Receipt procedure resulting in an acknowledgement code "AR" or "AE" does not constitute regulatory compliance.

The sender of a message that has been rejected by the EudraVigilance system in part or in total has the obligation to resubmit corrected versions immediately within the reporting timelines as defined in EU legislation, so that the message can be accepted in the locally established pharmacovigilance system of the Receiver. In validated and tested systems and after passing a production pilot testing, this should rarely occur.

The detailed steps in the Acknowledgement of Receipt procedure are as follows:

Following successful receipt of the Safety Message, the Report Receiver is responsible for loading the ICSR(s) into the locally established pharmacovigilance system. The Report Receiver is responsible for generating, at the latest within two business days, an Acknowledgement Message, providing the validation status of each ICSR, which is the subject of the Safety Message of the particular transmission.

The Acknowledgement Message can reflect three different types of transmission acknowledgements at Safety Message level:

**ACK code AA:** *Application Acknowledgement Accept* (message successfully processed, no further action)

**ACK code AE:** *Application Acknowledgment Error* (error detected, error response has additional detail, some ICSR message(s) need further action)

**ACK code AR:** *Application Acknowledgment Reject* (parsing error, no data extracted, re-send the entire transaction)

The Acknowledgement Message can reflect two different types of transmission acknowledgements at ICSR level:

**ICSR code CA:** *Commit Accept* (the ICSR message successfully loaded)

**ICSR code CR:** *Commit Reject* (the ICSR message contains fatal error that prevents the ICSR from being loaded)

An ICSR must be acknowledged by the Report Receiver with the ICSR acknowledgement code "CA" when it is in full compliance with the ICH and EU guidance documents. Thereupon it will be loaded into the Report Receiver's locally established pharmacovigilance system.

In case the validation status of one or more ICSRs within one Safety Message is assigned the ICSR acknowledgement code "CR", resulting in the transmission acknowledgement ACK code "AE" i.e. ICSR error, not all ICSRs loaded into the Report Receiver's locally established pharmacovigilance database, the Report Sender must retransmit, upon receipt of the Acknowledgement Message, immediately a corrected version of the affected ICSRs electronically, if the requirements of the validation are not met.

If, following the receipt of the Acknowledgement Message, the transmission acknowledgement code is "AR" in accordance with the relevant ISO 27953-2:2011 ICSR standard, ICH Implementation Guide and EU validation rules, the entire corrected Safety Message needs to be immediately retransmitted electronically. Safety Messages with the transmission acknowledgement code "AR" are not regarded as valid for reporting compliance purposes.

The Acknowledgement Message is sent by the Report Receiver of a Safety Message to the Report Sender of the Safety Message. At the Gateway level, an ICSRACK-MDN will be returned to the Sender of the Acknowledgement Message.

The date of the ICSRACK-MDN will serve as the official receipt date of the transmission of the Acknowledgement Message by the Gateway.

From a conceptual point of view the following principles apply:

- The Report Receiver of a Safety Message, that requires an acknowledgement, should not act upon the content of the Safety Message until such an ICSRACK is sent by the Report Receiver and successfully received by the Report Sender. If a Safety Message is entirely rejected (transmission acknowledgement code "AR") by the Report Receiver, the Report Receiver of the Safety Message should not act upon the content of the Safety Message until a corrected version is received and successfully acknowledged with an acknowledgement code "AA".
- If a Safety Message contains ICSR errors leading to a transmission acknowledgement code "AE", the Report Receiver of the Safety Message should not act upon the ICSRs with the ICSR acknowledgement code "CR" of this Safety Message until a corrected version of the ICSR(s) is received and successfully acknowledged with an ICSR acknowledgement code "CA".

However, if a rejected ICSR(s) within a Safety Message contains important safety information, which raises public health concerns, the Report Receiver in liaison with the Report Sender may act upon this ICSR(s).

The same requirements outlined above for the successful recognition of a Safety Message apply to the Acknowledgement Message. It is the sole responsibility of the Sender of the Acknowledgement

Message to ensure that these criteria are met and that the Acknowledgement Message can be recognised and routed successfully by the Gateway.

In summary, two different levels of acknowledgement are available.

One acknowledgment for the transmission of messages via the Gateway of the EDI partners, is the message disposition notification (MDN), which is automatically sent upon the receipt of an EDI Message being either a Safety or Acknowledgement Message at the level of the Receiver's Gateway without any content verification. This MDN is the proof to the Sender that a Safety Message was received successfully by the Receiver and serves as evidence for any reporting timeline compliance measures as defined in EU legislation, if the Safety Message was successfully validated and recognised in accordance with the ICH and requirements detailed in this document i.e. transmission acknowledgement code "AA" and ICSR acknowledgement code "CA".

The second, acknowledgement, is the Acknowledgement Message, which summarises the outcome of the Safety Message and ICSR validation by the Report Receiver.

If for technical reasons the Report Receiver does not return an MDN (being either an ICSR-MDN or an ICSRACK-MDN), the process described in I.C.2.1.6 "*What to do in system failure*" should be followed.

Figure 2 - EudraVigilance Safety Message (Msg) processing

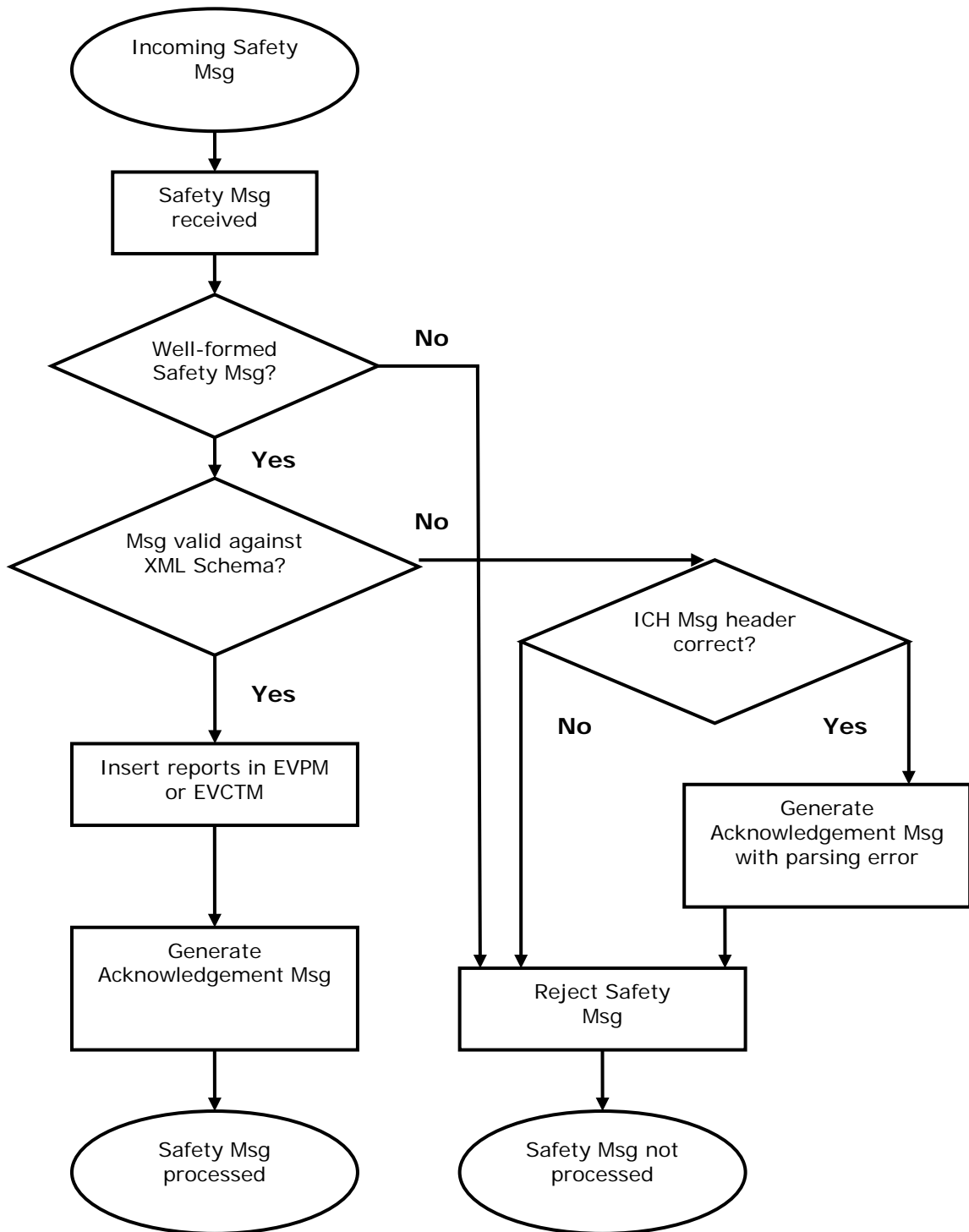

## ***I.C.2.2 Retransmission of ICSRs from EudraVigilance to National Competent Authorities***

The retransmission of valid post-authorisation ICSR to NCAs will only start 6-months after the announcement of a successfully audit of the EudraVigilance system. The retransmission of Clinical Trial SUSARs will only start after an official announcement that will be unrelated to the audit of EudraVigilance. The implementation of rerouting for post-authorisation ICSRs and SUSARs are likely to occur at different times and will be published separately to this implementation guide.

Before the start of retransmission of ICSRs organisations should continue reporting in line with published reporting requirements for post-authorisation ICSR and SUSARs from Clinical Trials.

The EMA will automatically forward on without delay copies of the valid post-authorisation ICSR and Clinical Trial SUSARs received into EudraVigilance to National Competent Authorities that have requested to receive them.

ICSRs that have parsing errors and ICSRs that contain errors resulting in the Acknowledgement Code "CR" (Commit Reject) will not be forwarded to NCAs. Original cases received from an NCA will be excluded from being retransmitted back to the sending NCA.

Save for periods of planned downtime of the EudraVigilance system the following timeframes will apply to the forwarding of valid ICSR:

- 95% of valid ICSRs will be re-routed to the relevant NCAs within 12 hours of receipt by the EV Gateway
- 99% of valid ICSRs received during EMA office hours will be re-routed to the relevant NCAs within 24 hours of receipt by the EV Gateway
- 99.9% of valid ICSRs will be re-routed to the relevant NCAs within 48 hours of receipt by the EV Gateway

The EudraVigilance system will retransmit messages as received, sections I.C.2.2.1 and I.C.2.2.2 describe the rules and processes for retransmission of ICH E2B(R3) messages. For the retransmission of ICH E2B(R2) messages please see the appendix I.D.4

NCAs should return acknowledgements for rerouted ICSRs within 48 hours of the initial receipt. If no acknowledgement is received within 48 hours, EudraVigilance will automatically resubmit the re-routed ICSRs. For resubmitted ICSRs NCAs should return acknowledgements within 24 hours. EudraVigilance will make a maximum of three attempts to resubmit ICSRs when no acknowledgement has been returned by an NCA. After the maximum number of attempts has been reached the NCA concerned will be contact by the EMA in order to understand if the NCA is experiencing technical issues.

### ***I.C.2.2.1 Retransmission rules for post-authorisation E2B(R3) ICSRs***

NCAs will provide and maintain a list of ISO 3166 country codes for which they wish to receive copies of ICSRs that have been entered in to EudraVigilance. An option to receive only serious ICSRs or all ICSRs will also be included. In addition NCAs will be able to request to receive ICSRs classified by the EMA, see section I.C.2.4 for further details.

The ICH E2B(R3) field *Reporter's Country Code* (C.2.r.3) will be used when the field *Primary Source for Regulatory Purposes* (C.2.r.5) is set to "1" to identify the National Competent Authority requesting that ICSR in accordance with the list of ISO 3166 country codes described above.



If any of the following ICH E2B(R3) fields in an ICSR are set to “true” the case will be considered serious and forwarded to an NCA that has specified that they only wish to receive serious cases:

- E.i.3.2a Results in Death
- E.i.3.2b Life Threatening
- E.i.3.2c Caused / Prolonged Hospitalisation
- E.i.3.2d Disabling / Incapacitating
- E.i.3.2e Congenital Anomaly / Birth Defect
- E.i.3.2f Other Medically Important Condition

The above check will not be performed for NCAs that have requested to receive both serious and non-serious cases.

The only defined ICH E2B(R3) fields that will be changed when retransmitting ICSRs will be the Batch wrapper fields as show in Table 1 below, non-ICH/EU data fields will not be retransmitted. The Message type (N.1.1) for these retransmissions will be “ichicsr”.

**Table 1 - Fields changed upon retransmission**

ICH E2B(R3) field code	ICH E2B(R3) field Description
N.1.2	Batch Number
N.1.3	Batch Sender Identifier
N.1.4	Batch Receiver Identifier
N.1.5	Date of Batch Transmission

Cases submitted by NCAs to EudraVigilance will not be retransmitted back to the sending NCA, this check will be based on the sending organisation's *Batch Sender Identifier* (N.1.3).

1. An Applicant, MAH or NCA sends ICSR(s) in a Safety Message to EudraVigilance;
2. EudraVigilance returns an Acknowledgement Message (ACK) to confirm the receipt of the Safety Message to the Sender.
3. EudraVigilance forwards the ICSR(s) in a Safety Message to the NCAs that have requested to receive them,
4. The NCA sends an Acknowledgement Message (ACK) to EVPM to confirm the receipt of the Safety Message.

**Figure 3 – Post-authorisation Exchange**

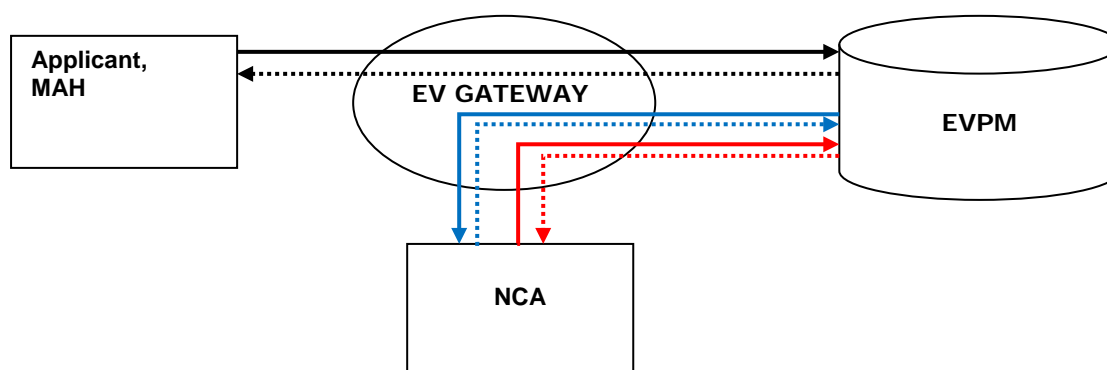

**Key**

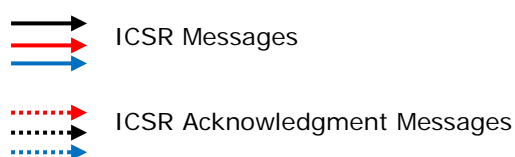

**I.C.2.2.2 Retransmission rules for Clinical Trial SUSARs**

An NCA can choose (from a list of country codes) the country/ies for which they wish to receive SUSAR reports. This will be done through matching the primary source country stated in the SUSAR report; additionally this will be done through matching the clinical trial unique number or alternatively through the suspect drug substance quoted in the SUSAR report, which equals the Member State country (based on country code) that approved the trial.

In addition to receiving SUSAR reports based on the primary source country NCAs can also choose to receive SUSAR reports based on one or more of the following criteria:

1. Receive EEA SUSARs based on the clinical trial unique number quoted in the report;
2. Receive EEA SUSARs based on suspect drug substance(s) in the report;
3. Receive non-EEA SUSARs based on the clinical trial unique number quoted in the report;
4. Receive non-EEA SUSARs based on the suspect drug substances specified in the report.

SUSARs only associated with EudraCT numbers are not subject to re-routing.

The only fields that will be changed when retransmitting ICSRs will be the Batch wrapper fields as show in Table 2 below, non-ICH/EU data fields will not be retransmitted. The Message type (N.1.1) for these retransmissions will be "ichicsr".

**Table 2 - Fields changed upon retransmission of a SUSAR**

ICH E2B(R3) field code	ICH E2B(R3) field Description
N.1.2	Batch Number
N.1.3	Batch Sender Identifier
N.1.4	Batch Receiver Identifier
N.1.5	Date of Batch Transmission

The examples in Figure 4 and Figure 5 reflect the exchange of a Safety Message including one or several ICSRs from a sponsor of an interventional clinical trial either directly to EudraVigilance or to an NCA who receives the SUSAR via alternative means and forwards it onto EudraVigilance Clinical Trial Module (EVCTM). The steps in these two reporting modes are highlighted below:

**Figure 4 - Clinical Trial SUSAR Exchange via EV Gateway**

1. An Sponsor sends an ICSR(s) in a Safety Message to EudraVigilance
2. EudraVigilance returns an Acknowledgement Message (ACK) to confirm the receipt of the Safety Message to the Sender
3. EudraVigilance forwards the ICSR(s) in a Safety Message to the NCAs that have requested to receive them
4. The NCA sends an Acknowledgement Message (ACK) to EVCTM to confirm the receipt of the Safety Message

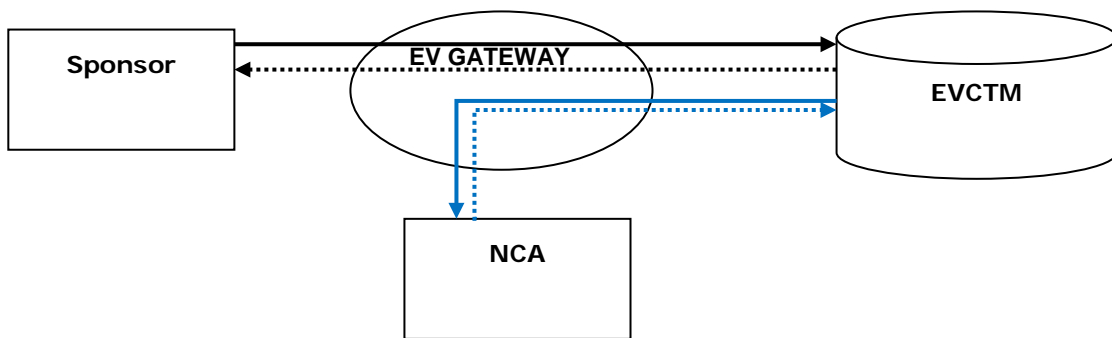

**Key**

- ICSR Messages
- ICSR Acknowledgment Messages

### Figure 5- Clinical Trial SUSAR Exchange via NCA

1. An Sponsor sends information about a SUSAR to an NCA
2. The NCA forwards the SUSAR to EVCTM
3. EudraVigilance returns an Acknowledgement Message (ACK) to confirm the receipt of the Safety Message to the NCA
4. EudraVigilance forwards the ICSR(s) in a Safety Message to other NCA(s) that have requested to receive them
5. The other NCA(s) send back an Acknowledgement Message (ACK) to EVPM to confirm the receipt of the Safety Message

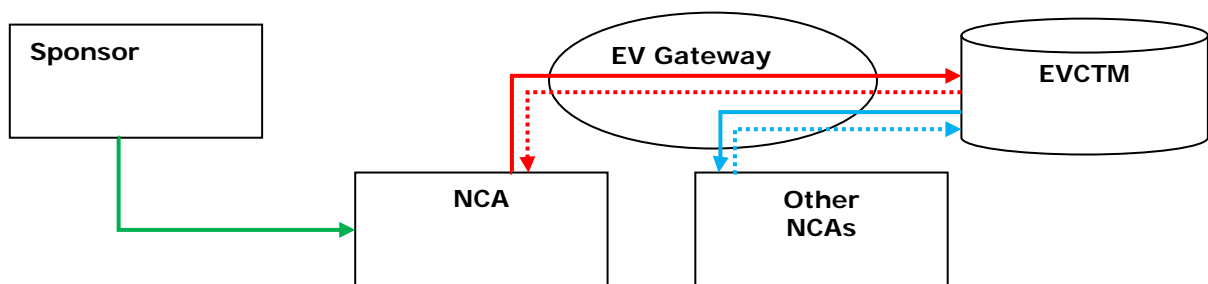

#### Key

- ICSR Messages
- ICSR Acknowledgment Messages
- Non EV gateway submission

The only fields that will be changed when retransmitting ICSRs will be the Batch wrapper fields as show in Table 3 below. The Message type (N.1.1) for these retransmissions will be "ichicsr".

**Table 3 - Fields changed upon retransmission**

ICH E2B(R3) field code	ICH E2B(R3) field Description
N.1.2	Batch Number
N.1.3	Batch Sender Identifier
N.1.4	Batch Receiver Identifier
N.1.5	Date of Batch Transmission

### ***I.C.2.3 Transmission of ICSRs entered into EudraVigilance by the EMA***

The EMA is required to perform the monitoring for literature articles for a defined list of substances and medical journals. ICSRs that are identified during this activity will be entered into EudraVigilance by the EMA in E2B(R3) format.

In addition the EMA is also required to identify and manage duplicated ICSRs in the EudraVigilance database. This is carried out through the creation of Master cases that are entered into EudraVigilance in E2B(R3) format. Further details on the management of duplicates can be found in section I.C.6.1. These master cases will be identifiable through the Message Type field as detailed in section I.C.3.1.1 .

The EMA will automatically forward on without delay copies of these valid post-authorisation ICSR and Clinical Trial SUSAR cases entered into EudraVigilance by the EMA to National Competent Authorities that have requested to receive them following the rules as outlined in section I.C.2.2 above in E2B(R3) format.

1. The EMA sends ICSR(s) in a Safety Message to EudraVigilance;
2. EudraVigilance returns an Acknowledgement Message (ACK) to confirm the receipt of the Safety Message to the EMA.
3. EudraVigilance forwards the ICSR(s) in a Safety Message to the NCAs that have requested to receive them,
4. The NCA sends an Acknowledgement Message (ACK) to confirm the receipt of the Safety Message.

**Figure 6 –Exchange of cases entered by EMA**

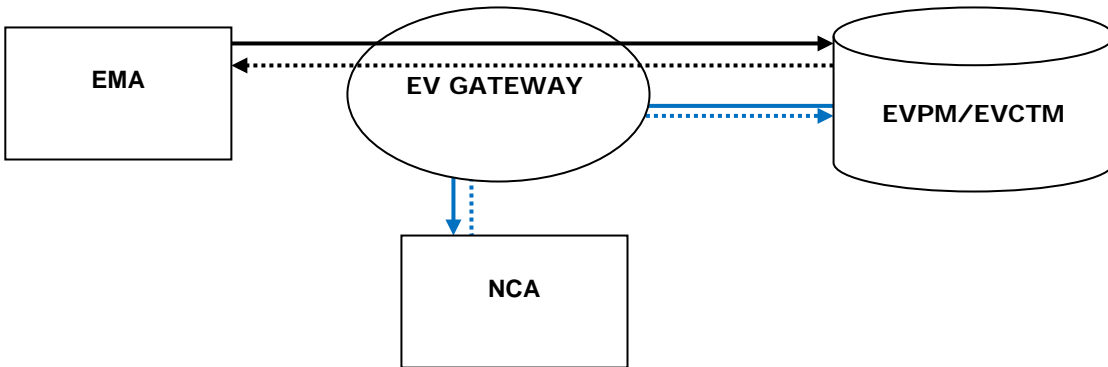

**Key**

- ICSR Messages
- ICSR Acknowledgment Messages

In order for NCAs to be able to identify which duplicated ICSRs have now been merged in to the new Master ICSR the fields ICH E2B(R3) fields in section *Other Case Identifiers in Previous Transmissions* C.1.9.1.r will be populated with the worldwide case IDs of the duplicated cases. This section will be repeated for each duplicated ICSR that has been merged under the Master case.

**Table 4 – Master case, fields for capturing the worldwide case ID of managed duplicate cases**

ICH E2B(R3) Field	Field Value	Description
C.1.9.1.r.1 - Source(s) of the Case Identifier	<b>EVDUP#SENDERID</b>	The following format will be used "EVDUP#" followed by the registered organisation identifier of the original source of the duplicate ICSR
C.1.9.1.r.2 - Case Identifier(s)	Worldwide case ID e.g. <b>GB-MAH1-123456</b>	The worldwide case ID of the duplicate ICSR

In the event that ICSRs are incorrectly identified as duplicated cases and Master case was created in error the EudraVigilance system will generate a Master nullification. The *message type* ICH E2B(R3) (N.1.1) will have the value "master" as described in section I.C.3.1.1 and the ICH E2B(R3) field *Report Nullification / Amendment* (C.1.11.1) will have the value "1". The same approach will apply for a master that is nullified due to underlying duplicate cases being nullified by the original senders. Please see section I.C.6.1. for further information on the handling of master cases.

#### ***I.C.2.4 Transmission of ICSRs classified in EudraVigilance by the EMA***

The EMA performs classification of product and substance information which has been received as free text in ICSRs. The classification process has two forms, automatic and manual. The automatic classification happens on a regular basis soon after an ICSR is received. The manual classification of product and substance information is required where the ICSRs have not been automatically classified.

The EMA will automatically forward copies of classified ICSRs to National Competent Authorities that have requested to receive them following the rules as outlined in section I.C.2.2 above in E2B(R3) format. In order to distinguish classified ICSRs from the version originally received and retransmitted from the classified ICSR version, these cases will be identifiable through the Message Type field as detailed in section I.C.3.1.1 Section I.C.6.2 has details on how the classified Medicinal Product Information will be provided.

1. The EMA classifies ICSR(s) in the EudraVigilance database;
2. EudraVigilance forwards the classified ICSR(s) in a Safety Message to the NCAs that have requested to receive them,
3. The NCA sends an Acknowledgement Message (ACK) to confirm the receipt of the Safety Message.

**Figure 7 – Transmission of classified cases in EudraVigilance**

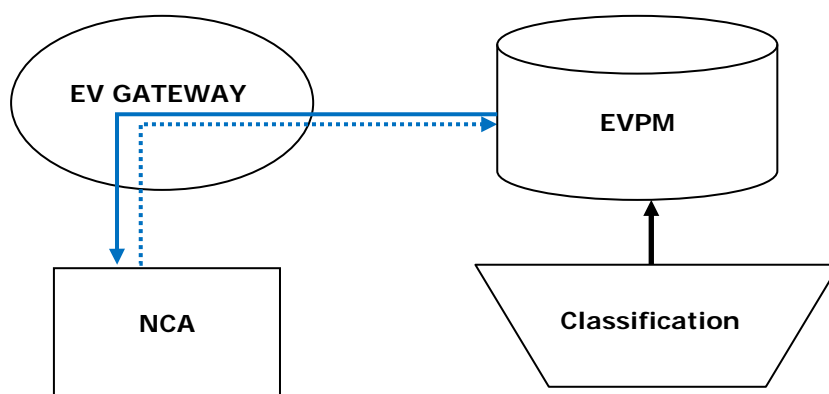

**Key**

- ICSR Messages
- ⋯→ ICSR Acknowledgment Messages

## I.C.3 ICH Safety Messages and Individual Case Safety Reports (ICSRs)

### I.C.3.1 Message Header

The XML message header contains two important references, the first is the Text encoding used within the XML file and the second refers to the location of the schema file that should be used to parse the XML file to ensure that it is correctly structured.

XML files can be submitted with the text encoding formats as provide in Table 5 below and as XML snippet shown in Figure 8 ICH E2B(R3) IG recommends the use of UTF-8 as the preferred encoding format. Table 5 below provides the text as it should appear in the XML file.

**Table 5 – XML text encoding**

Text encoding	XML file header
UTF-8	<?xml version="1.0" encoding="UTF-8"?>
UTF-16	<?xml version="1.0" encoding="UTF-16"?>

The schema location for ICSRs is the following:

[http://eudravigilance.ema.europa.eu/XSD/multicacheschemas/MCCI\\_IN200100UV01.xsd](http://eudravigilance.ema.europa.eu/XSD/multicacheschemas/MCCI_IN200100UV01.xsd)

The schema location for ICSR acknowledgements is the following

[http://eudravigilance.ema.europa.eu/XSD/multicacheschemas/MCCI\\_IN200101UV01.xsd](http://eudravigilance.ema.europa.eu/XSD/multicacheschemas/MCCI_IN200101UV01.xsd)

Figure 8 below is an XML snippet of the header of the ICSR message showing the text encoding used and the schema location.

**Figure 8 - XML Snippet: ICSR Header**

```
<?xml version="1.0" encoding="UTF-8"?>
<MCCI_IN200100UV01 ITSVersion="XML_1.0" xsi:schemaLocation="urn:hl7-org:v3
http://eudravigilance.ema.europa.eu/xsd/multicacheschemas/MCCI_IN200100UV01.xsd"
xmlns:xsi="http://www.w3.org/2001/XMLSchema-instance" xmlns="urn:hl7-org:v3">
```

### I.C.3.1.1 Message Type

When submitting a Safety Message to EV, the values accepted in the data element *Types of Message in batch* (ICH E2B(R3) N.1.1) are one of the following shown in Table 6 below. Two object identifiers (OID) exist, the first is the ICH OID which is for normal Safety Messages and the second is an EU specific OID for additional message types.

**Table 6 – Message Type, for all senders**

Value	Term	Object Identifier	Description
1	ichicsr	2.16.840.1.113883.3.989.2.1.1.1	For expedited ICSRs submitted to EVPM or EVCTM
1	backlog	2.16.840.1.113883.3.989.5.1.1.5.1	For retrospective ICSRs submitted to EVPM or EVCTM. This allows the exclusion of these reports from expedited reporting compliance checks. Prior agreement should be obtained with the receiver before submitting backlog messages.

Additional message types are used for the retransmission of ICSRs from EudraVigilance to National competent authorities and for the ICH E2B(R3) data made available through the EudraVigilance access policy. These additional message types are described in Table 7 below, these message types require the use of the specific EU Object Identifier.

**Table 7 – Additional Message Types, for EMA as sender**

Value	Term	Object Identifier	Description
2	master	2.16.840.1.113883.3.989.5.1.1.5.1	Duplicated cases are managed through a process of merging two-or-more cases into one Master Case created from identified duplicates see section I.C.6.1. for further details.
3	classified	2.16.840.1.113883.3.989.5.1.1.5.1	For the identifying ICSRs that have been updated due to classification activities
4	master classified	2.16.840.1.113883.3.989.5.1.1.5.1	For the identification of master cases that have been updated due to classification activities



### I.C.3.1.2 EudraVigilance Message Receiver Identifiers

Table 8 below provides the receiver identifiers that should be used in sending ICSR messages for processing by the different EudraVigilance modules.

Figure 9 is an XML snippet that shows how this information would appear within an ICSR message.

**Table 8 - EudraVigilance Message receiver IDs**

EudraVigilance system	N.1.4 Batch Receiver Identifier	N.2.r.3 Message Receiver Identifier
EVPM external testing environment	EVTEST	EVTEST
EVCTM external testing environment	EVCTMTEST	EVCTMTEST
EVPM production environment	EVHUMAN	EVHUMAN
EVCTM production environment	EVCTMPROD	EVCTMPROD

**Figure 9 - XML Snippet: Sender and Receiver details**

```
<id extension=" MAHNAME-2334456" root="2.16.840.1.113883.3.989.2.1.3.1"/>
  <creationTime value="20131204151617"/>
  <interactionId extension="PORR_IN049016UV" root="2.16.840.1.113883.1.6"/>
  <processingCode code="P"/>
  <processingModeCode code="T"/>
  <acceptAckCode code="AL"/>
  <receiver typeCode="RCV">
    <device classCode="DEV" determinerCode="INSTANCE">
      <id extension=" EVHUMAN" root="2.16.840.1.113883.3.989.2.1.3.12"/>
    </device>
  </receiver>
  <sender typeCode="SND">
    <device classCode="DEV" determinerCode="INSTANCE">
      <id extension="MAHID" root="2.16.840.1.113883.3.989.2.1.3.11"/>
    </device>
  </sender>
```

### I.C.3.2 Individual Case Safety Report (ICSR)

An ICH ICSR message can contain one or more ICSRs, although the ISO ICSR standard does not provide a maximum number of ICSRs that could be submitted in an ICSR message the recommendation is that organisations limit their systems to send no more than 100 ICSRs per message as resolving issues in submissions gets more complex when more ICSRs are included in one file. In order for efficient processing of messages it is required that the XML file size should be under 20Mb. Files above this size might cause potential issues with either parsing the message before sending the or the parsing and loading performed by the receiver.

Consideration should also be made for the impact on the file size when adding attachments such as literature articles to the ICSRs being submitted. Therefore organisations are encouraged to make sure that if scanned images or documents are being attached appropriate scanning resolutions are used for the document in order to minimise the file size. Text based PDFs rather than scanned image PDFs are

preferred. Controls or checks should be put in place to ensure that when creating ICSR messages that the attachment files size is not above 15Mb.

The file attachments of an ICSR above this maximum file size will not be processed, however the ICSR will be loaded and a warning message will be included in the acknowledgement, if there are no other validation issues the acknowledgement code "AA" will be returned. The sender of the ICSR should review if the attachment should have been sent and if so make efforts to reduce the file size if possible. If the attachment file size can be reduced an amendment report should be created and submitted.

When creating a safety message it should be noted that it is not possible to include follow-ups, nullifications and amendments concerning the same ICSR within the same safety message. If more than one version of an ICSR needs to be sent within the same timeframe this should be done by creating separate safety messages and submitting them in the correct chronological order.

### ***1.C.3.3 Attachments***

In order to provide supplemental information, the sender of an ISO ICSR can attach documents to the ICSR message itself. Attachments are provided as in-line data transmitted using the encapsulated data type.

The main usage of this field will be the provision of literature articles and any associated translation of the literature article into English. Other documents made available by a primary source (e.g. autopsy reports, ECG strips, chest X-ray, or photographs, etc.) can also be provided as attachments using the same method. However, additional documents should not be routinely attached to ICSRs. The main reasons for attaching these additional documents should either be at the request of the receiver on a case by case basis or where the correct medical interpretation of the ICSR cannot be made without access to the attachment(s).

If the sender of an ICSR holds additional (non-literature) documents the field C.1.6.1 (ICH E2B(R3)) should be entered as 'true' and a description of the document should be provided in the field C.1.6.1.r.1 (ICH E2B(R3)). The electronic version of the clinical document(s) can be provided as attachments in the field C.1.6.1.r.2 (ICH E2B(R3)). It should be noted if the receiver of the ICSR does not receive additional documents held by the sender and needs to subsequently forward the ICSR to another receiver the field C.1.6.1 (ICH E2B(R3)) should be amended on upon retransmission to indicate that they do not hold additional documents.

When a literature article is sent as an attachment, the literature citation in Vancouver style is captured in C.4.r.1 (ICH E2B(R3)) and the electronic version of the document (e.g. journal article) is attached to the ICSR in C.4.r.2 (ICH E2B(R3)), rather than in C.1.6.1.r.2 (ICH E2B(R3)). If an article has been previously submitted with an ICSR the same article document should not be resubmitted for any subsequent follow-up ICSRs.

Within one ICSR, multiple document titles (C.1.6.1.r) and literature titles (C.4.r.1) can be provided, as well as the associated materials. In line with GVP module VI if a literature article refers to more than one ICSR then the literature article should be attached to the first ICSR created only and all the associated ICSRs should be linked to the first ICSR through the linked report number C.1.10.r (ICH E2B(R3)).

**Table 9** below lists the file formats that are supported in the EU along with the Media type that should be provided in the relevant ICSR field.

**Table 9 – Supported file types in the EU**

File type extension	File type	Media Type (values)
PDF	Portable Document Format	application/pdf
JPEG/JPG	Joint Photographic Experts Group	image/jpeg
TXT	Text file	text/plain
RTF	Rich text file	text/rtf
TIFF/TIF	Tagged Image File Format	image/tiff
HTML	HyperText Markup Language	text/html
Doc	Word document	application/msword
Docx	Office Open XML (ISO/IEC 29500) wordprocessing	application/vnd.openxmlformats-officedocument.wordprocessingml.document
XLS	Excel document	application/vnd.ms-excel
XLSX	Office Open XML (ISO/IEC 29500) spreadsheet	application/vnd.openxmlformats-officedocument.spreadsheetml.sheet
DICOM	Digital Imaging and Communications in Medicine	application/dicom

Because documents might not be ready for transmission at the time of ICSR reporting, attachments can be transmitted separately from the ICSR transmission. When the sender transmits an attachment later, the original ICSR should be retransmitted along with the attachment in addition the field C.1.11.1 (ICH E2B(R3)) should be completed as an 'amendment' along with the reason for amendment field C.1.11.2 (ICH E2B(R3)) provided as transmission of attachment(s). If additional documents are subsequently received by the sender and contain medically relevant information a follow-up case containing the additional information should be created and submitted.

In order to submit an attachment the following fields need to be completed in the ISO ICSR message:

1. **Media Type:** This identifies the type of encapsulated data. The default value is text/plain, the correct value to use depends on the file type, the table above provides a list of the values to use
2. **Representation:** This identifies how the encapsulated data has been encoded. For text data this should have the value "TXT" for other file types binary data "B64" (base 64) should be used.
3. **Compression:** This indicates the data compression algorithm used. When binary (base 64) data is submitted the deflate algorithm RFC 19514 should be used "DF".

An example XML Snippet is given in Figure 10 below on how to provide information of a PDF literature article attachment.

<sup>4</sup> <http://www.ietf.org/rfc/rfc1951.txt>

**Figure 10 XML Snippet: PDF Literature Article Attachment**

```
<reference typeCode="REFR">
  <document classCode="DOC" moodCode="EVN">
    <code code="2" codeSystem="2.16.840.1.113883.3.989.2.1.1.27"
    displayName="literatureReference"/>
    <text mediaType="application/pdf" representation="B64" compression="DF">
omSJUEdmde9j44zmMiomSJUEdmde9j44zmMirdMDSsWdIJdksIJR3373jeu836edjz
MMIjdMDSsWdIJdksIJR3373jeu83MNYD83jmMdomSJUEdmde9j44zmMir...MNYD
83jmMdomSJUEdmde9j44zmMir6edjzMMIjdMDSsWdIJdksIJR3373jeu834zmMir6ed
jzMMIjdMDSsWdIJdksIJR3373jeu83==</text>
    <bibliographicDesignationText>Nirupen N et al. An unusual case of rash in an adult.
International Journal of Dermatology 2012;23(11):976-978.</bibliographicDesignationText>
  </document>
</reference>
```

An example XML Snippet is given below in Figure 11 on how to provide information on a JPEG photo that has been attached to the ICSR message.

**Figure 11 - XML Snippet: JPEG Photo attachment**

```
<reference typeCode="REFR">
  <document classCode="DOC" moodCode="EVN">
    <code code="1" codeSystem="2.16.840.1.113883.3.989.2.1.1.27"
    displayName="documentsHeldBySender"/>
    <title>Picture of the rash</title>
    <text mediaType="image/jpeg" representation="B64" compression="DF">
omSJUEdmde9j44zmMiomSJUEdmde9j44zmMirdMDSsWdIJdksIJR3373jeu836edjz
MMIjdMDSsWdIJdksIJR3373jeu83MNYD83jmMdomSJUEdmde9j44zmMir...MNYD
83jmMdomSJUEdmde9j44zmMir6edjzMMIjdMDSsWdIJdksIJR3373jeu834zmMir6ed
jzMMIjdMDSsWdIJdksIJR3373jeu83==</text>
  </document>
</reference>
```

### ***1.C.3.4 Use of local Language in Reaction/Event section and Case Summary section***

The requirements for the provision of local language in ICSRs submitted to EudraVigilance are given in GVP module VI, see section "VI.C.6.2.2.11. Handling of languages" for details.

It should be noted that if a report has been provided in English only the Case narrative field H.1 ICH E2B(R3) should be completed, this text should not be duplicated into the field H.5.r.1a "Case Summary and Reporter's Comments Text"

If the report includes local language the fields Reaction/Event as reported by the primary source in Native Language (E.i.1.1a) and Case Summary and Reporter's comments Text (H.5.r.1a) in ICH E2B(R3) should be completed with the information as received along with the applicable language code (E.i.1.1b & H.5.r.1b). If the sender has not received a case summary in local language the sender does not need to create a local language summary (H.5.r.1a)

### ***1.C.3.5 EU Causality Assessment Reporting in ICSRs***

The provisions regarding the recording and the notification of serious adverse reactions, related to interventional clinical trials for which at least one site is located within the European Economic Area (EEA), are defined in Article 16 and 17 of the Clinical Trials Directive 2001/20/EC.

In accordance with Article 16 of the Clinical Trials Directive the sponsor should keep detailed records of all adverse events which are reported to them by investigators.

Article 17 of the Clinical Trials Directive requires the sponsors to record and report on an expedited basis to the National Competent Authorities (NCAs) of the concerned Member States (MSs) all relevant information about Suspected Unexpected Serious Adverse Reactions (SUSARs) related to Investigational Medicinal Products (IMPs).

The Detailed Guidance ENTR/CT-3 recommends the investigator and the sponsor to evaluate the seriousness and the causality between the IMP and/or concomitant therapy and the adverse event(s). All adverse events judged by either the reporting investigator or the sponsor as having a reasonable causal relationship to the IMP (and/or concomitant therapy in case of suspicion of interaction with the IMP) should qualify as adverse reactions. The causality assessment given by the investigator should not be downgraded by the sponsor. If the sponsor disagrees with the investigator's causality assessment, both the opinion of the investigator and the sponsor should be provided.

In accordance with the Detailed Guidance ENTR/CT-3, serious unexpected adverse reactions with a reasonable causal relationship to an IMP (and/or concomitant therapy in case of suspicion of interaction with the IMP) qualify as SUSARs and are subject to expedited reporting. Serious expected adverse reactions and non-serious (expected and unexpected) adverse reactions suspected to be related to the IMP are not subject to expedited reporting. The same is also applicable for any adverse events and for any adverse reactions suspected to be related only to a medicinal product other than the IMP and for which there is no suspicion of interaction with the IMP. The Detailed Guidance defines other important safety issues (e.g. lack of efficacy of an IMP used for the treatment of a life-threatening disease) requiring expediting reporting and sets out the reporting format for these specific issues which should be notified to the relevant competent authority(ies) by letter. They should not be sent either electronically to the EudraVigilance Clinical Trial Module (EVCTM) or to the EMA by letter.

### **I.C.3.5.1 Data elements for Causality Assessments**

Numerous methods of causality assessment of adverse drug reactions have been published in the literature and are currently used worldwide. Based on this principle, the ISO ICSR standard allows the possibility to provide several results of causality assessment by using one or more methods of assessment.

For SUSAR reporting Medicinal products classified as suspect or interacting should have at least one method of assessment corresponding to the binary decision method detailed in the CIOMS Working Group VI report for each event/reaction reported in the ICSR. This method of assessment should be characterised with the value '1' in the data element *EU Method of Assessment* (EU E2B(R3) G.k.9.i.2.r.2.EU.1) this should be provided along with the EU Source of Assessment (G.k.9.i.2.r.1.EU.1) and the EU Result of the Assessment (G.k.9.i.2.r.3.EU.1) (1,2). The use of other methods of causality assessment is optional and can be provided in accordance with the ICH E2B(R3) Implementation Guide. In SUSARs where a Medicinal product is classified as "drug not administered" causality assessments are not required for that specific drug.

The EU Causality assessments described here can also be used for post-authorisation ICSRs, however this is not a mandatory requirement and the ICH free text fields can be used as described in ICH E2B(R3).

**Table 10 – EU Method of Assessment data element (G.k.9.i.2.r.2.EU.1)**

<b>G.k.9.i.2.r.2.EU.1- EU Method of Assessment</b>	
User Guidance	Method of assessment corresponding to the binary decision method detailed in the CIOMS Working Group VI report for each event/reaction reported in the ICSR
Conformance	Conditional-Mandatory
Data Type	2N
OID	2.16.840.1.113883.3.989.5.1.1.5.2
Value Allowed	1 – EU Method of Assessment
Business Rule(s)	For submissions to EVCTM Medicinal products classified as suspect or interacting (G.k.1 = 1,3) should have at least one EU method of assessment for each event/reaction reported in the ICSR. This is optional for ICSRs sent to EVHUMAN.

***I.C.3.5.1.1 EU Source of Assessment (EU E2B(R3) G.k.9.i.2.r.1.EU.1)***

The EU Source of Assessment data element allows the identification of the source of causality assessment (Investigator, Sponsor, NCA, MAH, Primary Source) that has been provided for each medicinal product classified as suspect or interacting with each event/reaction reported in the ICSR. For SUSAR reporting only the values (1-3) are applicable.

For post-authorisation reporting it is optional for senders to include structured causality assessments using the EU Method of Assessment; however only the values (3-6) can be used in this context.

A controlled vocabulary has been introduced in order to avoid errors in reporting. Only numerical values, as presented in Table 12, are accepted in the data element *EU Source of Assessment (EU E2B(R3) G.k.9.i.2.r.1.EU.1)*

**Table 11 – EU Source of Assessment data element (G.k.9.i.2.r.1.EU.1)**

<b>G.k.9.i.2.r.1.EU.1- EU Source of Assessment</b>	
User Guidance	Source of assessment corresponding to the binary decision method detailed in the CIOMS Working Group VI report for each event/reaction reported in the ICSR
Conformance	Conditional-Mandatory
Data Type	2N
OID	2.16.840.1.113883.3.989.5.1.1.5.4
Value Allowed	[1-6]
Business Rule(s)	Mandatory if G.k.9.i.2.r.2 = '1' Value must be [1-3] if the report is sent to EVCTM or [3-6] if sent to EVHUMAN

**Table 12 -Accepted values in the data element EU Source of Assessment (EU E2B(R3) G.k.9.i.2.r.1.EU.1)**

EU Source of Assessment (EU E2B(R3) G.k.9.i.2.r.1.EU.1)	VALUE
Investigator	1
Sponsor	2
NCA	3
MAH	4
Health Care professional	5
Non-Health care professional	6

***I.C.3.5.1.2 EU Result of Assessment (EU E2B(R3) G.k.9.i.2.r.3.EU.1)***

This data element is used to submit the result of the causality assessment of each medicinal product classified as suspect or interacting for each event/reaction reported in the ICSR. A controlled vocabulary has been introduced in order to avoid errors in the reporting of causality assessment results in accordance with the binary decision method described in I.C.3.5. Only numerical values, as presented in Table 13, are accepted in the data element *EU Result of Assessment (ICH E2B (R3) G.k.9.i.2.r.3.EU.1)* when the *EU Method of Assessment (EU E2B(R3) G.k.9.i.2.r.2.EU.1)* has the value '1'.

When using other methods of causality assessment, the sponsor should decide which categories of causality assessment result correspond to 'Reasonable possibility' and which ones refer to 'No reasonable possibility'.

**Table 13 Accepted values in the data element EU Result of Assessment (EU E2B(R3) G.k.9.i.2.r.3.EU.1)**

EU Result of Assessment (EU E2B(R3) G.k.9.i.2.r.3.EU.1)	VALUE
Reasonable possibility	1
No reasonable possibility	2

Each MedDRA LLT code reported in the data element Reaction / Event (MedDRA code) (ICH E2B(R3) E.i.2.1b) should have an assessment provided by the Investigator AND/OR by the Sponsor for each reported medicinal product classified as suspect or interacting. Failure to comply with this requirement generates an error acknowledgement.

Any initial ICSR submitted to EVCTM should contain at least one reaction with a causality assessment 'Reasonable possibility' to at least one of the reported medicinal products classified as suspect or interacting. If this information is not available, the ICSR submitted to EVCTM is classified as an error report and requires correction and resubmission if applicable. This rule is not applied to follow-up ICSRs submitted to EVCTM in order to allow sponsors the possibility to downgrade the causality of an initial ICSR.

When the sponsor is sending the report at an early stage and does not have sufficient information to assign causalities between the reported medicinal products classified as suspect or interacting and the reported adverse events/reactions, a 'Reasonable possibility' of causal association should be considered until further information is available to confirm or downgrade the initially reported causality.

**Table 14 - EU Result of Assessment data element (G.k.9.i.2.r.3.EU.1)**

G.k.9.i.2.r.3.EU.1- EU Result of Assessment	
User Guidance	The CIOMS Working Group VI binary decision causality assessment
Conformance	Conditional-Mandatory
Data Type	2N
OID	2.16.840.1.113883.3.989.5.1.1.5.3
Value Allowed	[1-2]
Business Rule(s)	Mandatory if G.k.9.i.2.r.2 = '1'

### ***I.C.3.5.1.3 Causality Assessment Example***

An example XML Snippet is given below in

**Figure 12** on how to provide information on an EU causality assessment within an ISO ICSR message for a SUSAR submission to EVCTM.

**Figure 12 - XML Snippet: SUSAR EVTCM Causality Assessments**

```

<component typeCode="COMP">
  <causalityAssessment classCode="OBS" moodCode="EVN">
    <code code="39" codeSystem="2.16.840.1.113883.3.989.2.1.1.19"
    displayName="causality"/>
    <value xsi:type="CE" code="1"
    codeSystem="2.16.840.1.113883.3.989.5.1.1.5.3" displayName="Reasonable
    possibility"/>
    <methodCode code="1" codeSystem="2.16.840.1.113883.3.989.5.1.1.5.2"
    displayName="EU Assessment"/>
    <author typeCode="AUT">
      <assignedEntity classCode="ASSIGNED">
        <code code="1" codeSystem="2.16.840.1.113883.3.989.5.1.1.5.4"
        displayName="Investigator"/>
      </assignedEntity>
    </author>
    <subject1 typeCode="SUBJ">
      <adverseEffectReference classCode="OBS" moodCode="EVN">
        <id root="154eb889-958b-45f2-a02f-42d4d6f4657f"/>
      </adverseEffectReference>
    </subject1>
    <subject2 typeCode="SUBJ">
      <productUseReference classCode="SRADM" moodCode="EVN">

```

### ***I.C.3.6 Additional ISO/HL7 ICSR Data Fields for EU Regional Implementation***

This section of the implementation guide is subject to change as it depends on the outcome of documents currently being produced in ISO which were not available at the time of writing this Implementation Guide.



### **I.C.3.6.1 Integration with ISO IDMP Standards**

The five ISO IDMP standards listed below apply to both authorised and developmental medical products that are regulated in the EU and should be used in ISO ICSR submissions to EudraVigilance when available for use in the EU:

- ISO 11615, Health Informatics – Identification of Medicinal Products – Data elements and structures for the unique identification and exchange of regulated medicinal product information.
- ISO 11616, Health Informatics – Identification of Medicinal Products – Data elements and structures for the unique identification and exchange of regulated pharmaceutical product information.
- ISO 11238, Health Informatics – Identification of Medicinal Products – Data elements and structures for the unique identification and exchange of regulated information on substances.
- ISO 11239, Health Informatics – Identification of Medicinal Products – Data elements and structures for the unique identification and exchange of regulated information on pharmaceutical dose forms, units of presentation, routes of administration and packaging
- ISO 11240, Health Informatics – Identification of Medicinal Products – Data elements and structures for the unique identification and exchange of units of measurement.

With the exception of ISO 11240 (UCUM) which is already a fully integrated part of the ISO ICSR standard, the implementation of the ISO IDMP standards was not included in the ICH E2B(R3) Implementation Guide and was left to ICH regions to provide their own implementation guides on the use of these standards.

This section of the EU ICSR Implementation Guide describes the use of the data content of these standards when they become available for use in the EU. If the data content are not available then in line with ICH E2B(R3) specifications the previous vocabulary lists provided in ICH E2B(R2) or free text should be used.

#### ***I.C.3.6.1.1 Use of UCUM units***

The UCUM standard specifies the usage of an algorithm to validate the correct format of a unit. This algorithm does not however indicate if the unit is appropriate for the field it is being used in e.g. Lab test result unit being used in a drug dosage field.

ICH has published a list of UCUM units for use in the ICH E2B(R3) drug dosage and cumulative dosage fields, this list includes all the units previously used in ICH E2B(R2) ICSRs. Currently ICH has not published a list of valid UCUM units for use in the Lab test unit field F.r.3.3. To support stakeholders, a list of valid Lab test units has been made published for use in the EU. This list incorporates a free to use list of common Lab test units published by LOINC<sup>5</sup> and has been extended to include additional lab test units that have been frequently used in reporting ICSRs in ICH E2B(R2) format. This list is in Excel format and is available from the EudraVigilance page of the EMA website<sup>6</sup>. The Excel list includes columns to indicate if the UCUM unit is suitable for use as a Lab unit (F.r.3.3), Dose unit (G.k.5b & G.k.4.r.1b) and Strength Unit (D.8.r.EU.r.3b, D.10.8.r.EU.r.3b & G.k.2.3.r.3b).

---

<sup>5</sup> <https://loinc.org/usage/units>

<sup>6</sup> [http://www.ema.europa.eu/ema/index.jsp?curl=pages/regulation/q\\_and\\_a/q\\_and\\_a\\_detail\\_000165.jsp&mid=WC0b01ac0580a69263](http://www.ema.europa.eu/ema/index.jsp?curl=pages/regulation/q_and_a/q_and_a_detail_000165.jsp&mid=WC0b01ac0580a69263)

Any valid current term in the published UCUM list can be used in these unit fields however if the unit is marked as unsuitable for that field the EudraVigilance business rules will generate warning message in order to indicate a possible data quality issue.

### ***I.C.3.6.1.2 Medicinal Product Identifier (MPID)***

The Medicinal Product Identifier is the most precise level of identifying the product given to the patient. These identifiers should only be used when the information provided by the primary source includes the MPID or if enough information is provided by the primary source so that the correct MPID can be selected unambiguously.

Organisations creating ICSR messages should not modify the MPID information based on the territory of the receiving organisation. For example if an ICSR concerning an ADR that occurred in the US contains the US MPID this MPID should not be replaced with an EU MPID for a similar product. Figure 13 below provides an example XML snippet showing how the MPID should be provided within an ICSR message.

**Table 15 - MPID Version Date/Number data element (G.k.2.1.1a, D.8.r.2a, D.10.8.r.3a)**

<b>G.k.2.1.1a, D.8.r.2a, D.10.8.r.3a - MPID Version Date/Number</b>	
User Guidance	This data element captures the version date/number of the MPID
Conformance	Conditional-mandatory
Data Type	To be confirmed after ISO IDMP IGs are made available
OID	To be confirmed after ISO IDMP IGs are made available
Value Allowed	To be confirmed after ISO IDMP IGs are made available
Business Rule(s)	Mandatory if D.8.r.2b, D.10.8.r.2b, G.k.2.1.1b is populated

**Table 16 - Medicinal Product Identifier (MPID) data element (G.k.2.1.1b, D.8.r.2b, D.10.8.r.3b)**

<b>G.k.2.1.1b, D.8.r.2b, D.10.8.r.3b- Medicinal Product Identifier (MPID)</b>	
User Guidance	This data element captures the Medicinal Product Identifier (MPID)
Conformance	Optional
Data Type	250AN
OID	To be confirmed after ISO IDMP IGs are made available
Value Allowed	Free Text
Business Rule(s)	Mandatory if D.8.r.2a, D.10.8.r.2a, G.k.2.1.1a is populated

**Figure 13 - XML Snippet for the MPID**

```
<code code="4" codeSystem="2.16.840.1.113883.3.989.2.1.1.20"
displayName="drugInformation"/>
  <component typeCode="COMP">
    <substanceAdministration classCode="SBADM" moodCode="EVN">
      <id root="3c91b4d5-e039-4a7a-9c30-67671b0ef9e4"/>
      <consumable typeCode="CSM">
        <instanceOfKind classCode="INST">
          <kindOfProduct classCode="MMAT" determinerCode="KIND">
            <code code="GB-XYZ Pharma-13456" codeSystem="EU.OID.MPID"
codeSystemVersion="1"/>
            <name>Fastaction FlexPen 100 IU/ml Solution for injection</name>
```

### **I.C.3.6.1.3 Pharmaceutical Product Identifier (PhPID)**

The Pharmaceutical Product Identifier is the next level of precision down from MPID. The PhPID can be used to link MPIDs that have the similar composition. The PhPID itself also contains different levels of precision based on the known information on medicinal products. The PhPID levels are shown in Table 17 below.

**Table 17 – Levels of the PhPID**

PhPID Type	Level	Composition
PhPID Active Substance Stratum	L1	Substance(s) Term
	L2	Substance Term(s) + Strength + Reference Strength (if applicable)
	L3	Substance Term(s) + Administrable Dose Form
	L4	Substance(s) Term+ Strength + Reference Strength (if applicable) + Administrable Dose Form
PhPID Specified Substance Stratum	L1	Specified Substance(s) Term
	L2	Specified Substance Term(s) + Strength + Reference Strength (if applicable)
	L3	Specified Substance Term(s) + Administrable Dose Form
	L4	Specified Substance(s) Term+ Strength + Reference Strength (if applicable) + Administrable Dose Form

A pharmaceutical product may refer to a drug that is associated with a medical device (e.g. drug/device, biologic/device). In these instances, the device term and term ID (unique device identifier) will be displayed with the substance(s) and specified substance(s) terms for the product at all applicable PhPID levels as shown in the table above.

The PhPID that is closest to the information reported by the primary source should be selected if the MPID is not known. It should be noted that the PhPID does not include brand/invented name, if the constituents of the reported brand/invented name are known and the MPID cannot be chosen the PhPID should be selected and the brand/invented name should be provided in the relevant product name part. Figure 14 below shows an XML snippet for how the PhPID should be provided within an ICSR message.

**Table 18 - PhPID Version Date/Number data element (D.8.r.3a, D.10.8.r.3a, G.k.2.1.2a)**

D.8.r.3a, D.10.8.r.3a, G.k.2.1.2a - PhPID Version Date/Number	
User Guidance	This data element captures the version date/number of the PhPID, required if PhPID is provided
Conformance	Conditional-mandatory
Data Type	To be confirmed after ISO IDMP IGs are made available
OID	To be confirmed after ISO IDMP IGs are made available
Value Allowed	To be confirmed after ISO IDMP IGs are made available
Business Rule(s)	Mandatory if D.8.r.3b, D.10.8.r.3b, G.k.2.1.2b is populated

**Table 19 – Pharmaceutical Product Identifier (PhPID) data element (D.8.r.3b, D.10.8.r.3b, G.k.2.1.2b)**

D.8.r.3b, D.10.8.r.3b, G.k.2.1.2b - Pharmaceutical Product Identifier (PhPID)	
User Guidance	This data element captures the Pharmaceutical Product Identifier (PhPID).
Conformance	Optional
Data Type	1000AN - To be confirmed after ISO IDMP IGs are made available
OID	To be confirmed after ISO IDMP IGs are made available
Value Allowed	Free Text
Business Rule(s)	Mandatory if D.8.r.3a, D.10.8.r.3a, G.k.2.1.2a is populated

**Figure 14 - XML Snippet for PhPID**

```

<code code="4" codeSystem="2.16.840.1.113883.3.989.2.1.1.20"
  displayName="drugInformation"/>
  <component typeCode="COMP">
    <substanceAdministration classCode="SBADM" moodCode="EVN">
      <id root="3c91b4d5-e039-4a7a-9c30-67671b0ef9e4"/>
      <consumable typeCode="CSM">
        <instanceOfKind classCode="INST">
          <kindOfProduct classCode="MMAT" determinerCode="KIND">
            <code code="13456" codeSystem="EU.OID.PHPID" codeSystemVersion="1"/>
            <name>Fastaction FlexPen 100 IU/ml Solution for injection</name>
          </kindOfProduct>
        </instanceOfKind>
      </consumable>
    </substanceAdministration>
  </component>

```

**I.C.3.6.1.4 Product Name Parts**

Medication Name Parts are a means of specifying the name of a product as separated components. This allows for input name strings to be automatically matched to possible medical products, rather

than through manual classification activities. The product name parts should be used if the MPID cannot be selected and if the medicinal product has been reported as a brand/invented name.

Details on the product name qualifiers available in the ISO ICSR standard are provided in Table 20 below, Figure 15 provides an XML snippet to show how this information is represented within an ICSR message.

**Table 20 – Product name parts – Codes and definitions**

Concept Code	Concept Name	Definition	Example
<b>CON</b>	container name	This refers to the container if present in the medicinal product name.	For Totalflu suspension for injection in pre-filled syringe Influenza vaccine (surface antigen, inactivated, prepared in cell culture) (2009/2010 season): <b>pre-filled syringe</b>
<b>DEV</b>	device name	This refers to the qualifiers in the name for devices and is at the moment mainly applicable to insulins and inhalation products.	For the medicinal product Fastaction InjectPen 100 IU/ml Solution for injection: <b>InjectPen</b>
<b>FRM</b>	form name	This refers to the pharmaceutical form/ if present in the medicinal product name.	For Discopan 50 mg soft capsules: <b>Soft Capsules</b> For Fuldimil 25mg-Filmtabletten: <b>Filmtabletten</b> For Totalflu suspension for injection in pre-filled syringe Influenza vaccine (surface antigen, inactivated, prepared in cell culture) (2009/2010 season): <b>suspension for injection</b>
<b>INV</b>	invented name	This refers to the product name without the trademark or the name of the marketing authorization holder or any other descriptor reflected in the product name and, if appropriate, whether it is intended e.g. for babies, children or adults.	Discopan Totalflu Fuldimil
<b>SCI</b>	scientific name	This refers to the product common or scientific name without the trademark or the name of the marketing authorization holder or any other descriptor reflected in the product name.	For Discopan: <b>N/A</b> For Totalflu: <b>Influenza vaccine (surface antigen, inactivated, prepared in cell culture) (2009/2010 season)</b> For Fuldimil: <b>N/A</b>
<b>STR</b>	strength name	This refers to the strength if present in the medicinal product name.	For Discopan 50 mg soft capsules: <b>50mg</b> For Fuldimil 25mg-Filmtabletten: <b>25 mg</b> For Totalflu suspension for injection in pre-filled syringe Influenza vaccine

Concept Code	Concept Name	Definition	Example
			(surface antigen, inactivated, prepared in cell culture) (2009/2010 season): <b>N/A</b>
<b>TMK</b>	trademark name	This refers to trademark/company element if present in the medicinal product name.	For Insulin Human Syncopharm Comb 15: <b>Syncopharm</b>
<b>USE</b>	intended use name	This refers to the intended use if present in the medicinal product name without the trademark or the name of the marketing authorization holder or any other descriptor reflected in the product name e.g. intended for babies, children or adults.	For MultiCure heartburn relief: <b>heartburn relief</b>

**Table 21 – Name part data element (G.k.2.2.EU.1)**

G.k.2.2.EU.1 - Name part	
User Guidance	A qualifier from the list provided in the table above must be provided along with the name part being provided.
Conformance	Optional
Data Type	1000AN
OID	None
Value Allowed	Free text
Business Rule(s)	None

**Figure 15 - XML Snippet for Product Name Parts**

```

<code code="4" codeSystem="2.16.840.1.113883.3.989.2.1.1.20"
  displayName="drugInformation"/>
  <component typeCode="COMP">
    <substanceAdministration classCode="SBADM" moodCode="EVN">
      <id root="3c91b4d5-e039-4a7a-9c30-67671b0ef9e4"/>
      <consumable typeCode="CSM">
        <instanceOfKind classCode="INST">
          <kindOfProduct classCode="MMAT" determinerCode="KIND">
            <code code="G.k.2.1.1b" codeSystem="TBD-MPID"
              codeSystemVersion="G.k.2.1.1a"/>
            <name>Fastaction FlexPen 100 IU/ml Solution for injection
              <delimiter qualifier="INV">Fastaction</delimiter>
              <delimiter qualifier="DEV">FlexPen</delimiter>
              <delimiter qualifier="STR">100 IU/ml</delimiter>
              <delimiter qualifier="FRM">Solution for injection</delimiter>
            </name>
          </kindOfProduct>
        </instanceOfKind>
      </consumable>
    </substanceAdministration>
  </component>

```

### ***I.C.3.6.1.5 Substance/Specified Substance TermID***

The substance ID should be used when a PhPID does not exist but a substance name has been assigned an ID and that is known by the sender e.g. developmental medicinal products.

If a MPID, PhPID or substance ID is not available and the Substance name is known then this can be entered as free text in the field (ICH E2B(R3) - G.k.2.3.r.1). An example XML snippet is provided in Figure 16 to show how this information would be represented in an ICSR message.

**Table 22 - Substance/Specified Substance TermID Version Date/Number data element (D.8.r.EU.r.2a, D.10.8.r.EU.r.2a, G.k.2.3.r.2a)**

<b>D.8.r.EU.r.2a, D.10.8.r.EU.r.2a, G.k.2.3.r.2a - Substance/Specified Substance TermID Version Date/Number</b>	
User Guidance	This data element captures the version date/number of the <b>Substance/Specified Substance TermID</b>
Conformance	Conditional-mandatory
Data Type	To be confirmed after ISO IDMP IGs are made available
OID	To be confirmed after ISO IDMP IGs are made available
Value Allowed	To be confirmed after ISO IDMP IGs are made available
Business Rule(s)	Mandatory if G.k.2.3.r.2b is populated.

**Table 23 - Substance/Specified Substance TermID data element (D.8.r.EU.r.2b, D.10.8.r.EU.r.2b, G.k.2.3.r.2b)**

<b>D.8.r.EU.r.2b, D.10.8.r.EU.r.2b, G.k.2.3.r.2b - Substance/Specified Substance TermID</b>	
User Guidance	If both MPID (G.k.2.1.1) and PhPID (G.k.2.1.2) are unavailable, use the Substance Name TermID
Conformance	Optional
Data Type	To be confirmed after ISO IDMP IGs are made available
OID	To be confirmed after ISO IDMP IGs are made available
Value Allowed	To be confirmed after ISO IDMP IGs are made available
Business Rule(s)	Mandatory if G.k.2.3.r.2a is populated

**Figure 16 - XML Snippet: Substance Name**

```
<ingredientSubstance classCode="MMAT" determinerCode="KIND">
  <code code="G.k.2.3.r.2b" codeSystem="TBC-Substance"
codeSystemVersion="G.k.2.3.r.2a"/>    <name>Paracetamol</name>
</ingredientSubstance>
```

### ***I.C.3.6.1.6 Decision flow diagram for entering Medicinal Product Information***

From the guidance provided above the following decision tree provided in Figure 17 should be used for entering medicinal product information. Although the product name as reported by the primary source is a mandatory field the sender of ISO ICSRs should attempt to code the verbatim text using ISO IDMP identifiers where available and if appropriate provide structured name parts.

If the sender can answer 'yes' to a question listed in the diagram below this is the information that should be provided in the ISO ICSR message in addition to the product name as provided by the primary source. If the answer is 'no' then the sender should progress to the next question.

**Figure 17 – Medicinal product information data entry decision flow diagram**

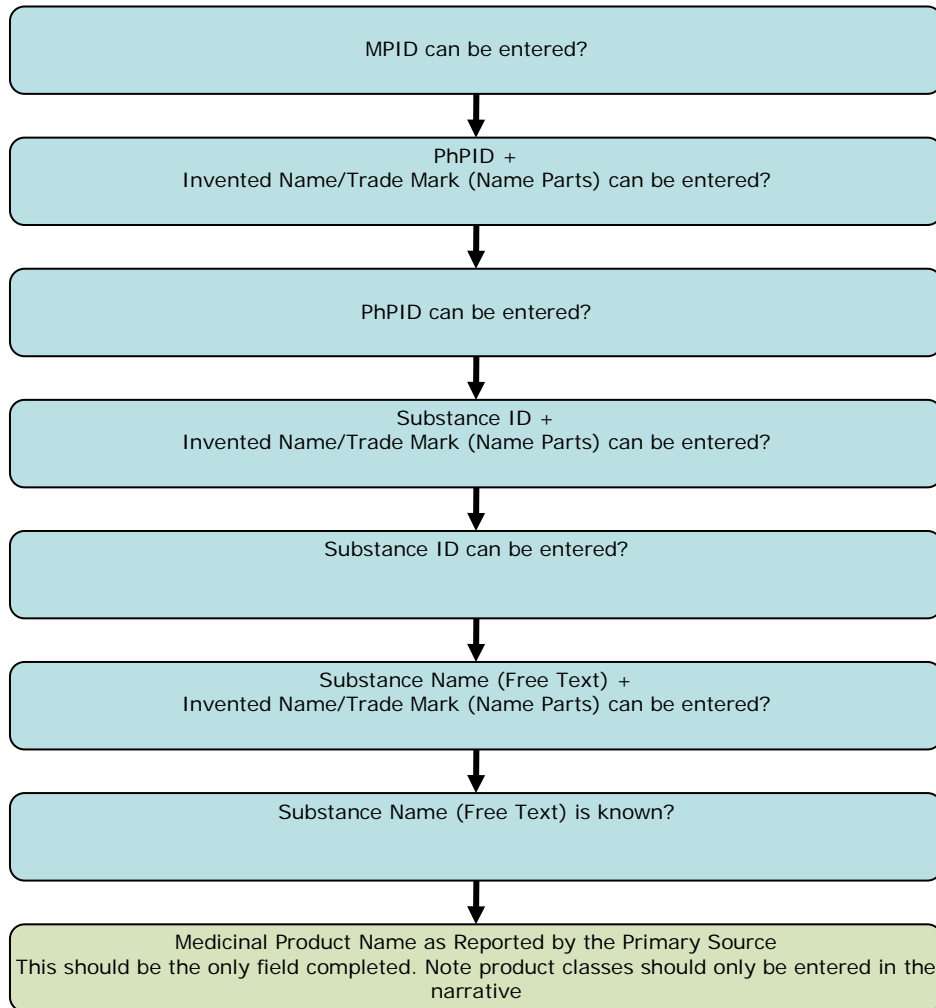

### **I.C.3.6.2 Biological Products requiring Batch Number**

For suspected adverse reactions relating to biological medicinal products, the definite identification of the concerned product with regard to its manufacturing is of particular importance. Therefore, all appropriate measures should be taken to clearly identify the name of the product and the batch number. A business process map in relation to the mandatory follow-up of information for the identification of suspected biological medicinal products is presented in Appendix 1 of GVP module VI.



For cases related to vaccines, the recommendations provided in the Guideline on the conduct of Pharmacovigilance for Vaccines for Pre-and Post-exposure Prophylaxis against Infectious Diseases<sup>7</sup> should also be followed as appropriate. An example XML snippet is provided in Figure 18 to show how missing information would be represented in an ICSR message.

**Table 24 - Batch / Lot Number Data element (G.k.4.r.7)**

G.k.4.r.7 - Batch / Lot Number	
User Guidance	Field should be completed with a value or an appropriate null flag for all suspect or interacting drugs. The nullflavor "ASKU" should be completed for biological products where the primary source has been contacted for this information but was unable to provide it. For all other situations the nullflavor "UNK" should be used when this information is missing.
Conformance	Conditional-Mandatory
Data Type	35AN
OID	-
Value Allowed	Free Text nullFlavor: UNK or ASKU
Business Rule(s)	Field should be completed with a value or an appropriate null flag for all suspect or interacting drugs, G.k.1 = '1' or '3'

**Figure 18 - XML Snippet: Batch / Lot Number – NullFlavor**

```
<productInstanceInstance classCode="MMAT" determinerCode="INSTANCE">
  <lotNumberTex nullFlavor="UNK" />
</productInstanceInstance>
```

### I.C.3.6.3 Device Component

For suspected adverse reactions relating to that involve device component(s) related to advance therapies or medicinal products, the following fields are available in the ISO ICSR standard in order to capture specific information about the component(s). This information can be important where the reporter has suspected that the device component may have led to the adverse reaction experienced by the patient or in cases of device failure.

The device component of a medicinal product is likely to have its own serial or batch number in addition to the package level serial or batch number. If this information is provided it should be entered in this section, if no information is available this section should not be provided. An example XML snippet is provided in Figure 19 to show how the device information would be represented in an ICSR message.

<sup>7</sup> (Ref.: [EMEA/CHMP/PhVWP/503449/2007](http://www.emea.europa.eu/PhVWP/503449/2007))

**Table 25 - Device Component name data element (G.k.2.2.EU.9.r.1)**

G.k.2.2.EU.9.r.1 - Device Component name	
User Guidance	This field can be used to specify the name of the device where applicable as text.
Conformance	Optional
Data Type	250AN
OID	-
Value Allowed	Free Text
Business Rule(s)	Not allowed if G.k.2.1.1 is provided.

**Table 26 - Device Component TermID version Date/Number data element (G.k.2.2.EU.9.r.2)**

G.k.2.2.EU.9.r.2 Device Component TermID version Date/Number	
User Guidance	This data element captures the version date/number of the <b>Device component TermID</b> . If Device component TermID is known the TermID version must also be provided
Conformance	Conditional-Mandatory
Data Type	To be confirmed after ISO IDMP IGs are made available
OID	-
Value Allowed	To be confirmed after ISO IDMP IGs are made available
Business Rule(s)	Required if G.k.2.2.EU.9.r.3 is provided

**Table 27 - Device Component TermID data element (G.k.2.2.EU.9.r.3)**

G.k.2.2.EU.9.r.3 - Device Component TermID	
User Guidance	The Device component TermID should be provided if known
Conformance	Optional
Data Type	To be confirmed after ISO IDMP IGs are made available
OID	To be confirmed after ISO IDMP IGs are made available
Value Allowed	To be confirmed after ISO IDMP IGs are made available
Business Rule(s)	Required if G.k.2.2.EU.9.r.2 is provided

**Table 28 - Device Batch Lot number (G.k.2.2.EU.9.r.4)**

G.k.2.2.EU.9.r.4 - Device Batch Lot number	
User Guidance	The batch lot number if applicable to a unique device.

G.k.2.2.EU.9.r.4 - Device Batch Lot number	
Conformance	Optional
Data Type	To be confirmed after ISO IDMP IGs are made available
OID	To be confirmed after ISO IDMP IGs are made available
Value Allowed	To be confirmed after ISO IDMP IGs are made available
Business Rule(s)	None

**Figure 19 - XML Snippet: Device Component**

```

<productInstanceInstance classCode="MMAT" determinerCode="INSTANCE">
  <lotNumberText>G.k.4.r.7</lotNumberText>
  <!-- G.k.4.r.7: Batch / Lot Number #1-1 of drug component in all medicines-->
  <!-- Combined product advanced therapy device part batch below part class code should be "PART" -->
  <part classCode="PART">
    <partDeviceInstance classCode="DEV">
      <lotNumberText>G.k.2.2.EU.9.r.4</lotNumberText>
      <!-- G.k.2.2.EU.9.r.4: Batch / Lot Number #1-1 of the Device component in advanced therapy-->
      <asInstanceOfKind>
        <kindOfMaterialKind>
          <code code="G.k.2.2.EU.9.r.3" codeSystem="EUOID" codeSystemVersion="G.k.2.2.EU.9.r.2" />
          <!-- G.k.2.2.EU.9.r.3: Device Component TermID-->
          <!-- G.k.2.2.EU.9.r.2: Device Component TermID version Date/Number-->
          <name>Enter G.k.2.2.EU.9.r.1</name>
          <!-- G.k.2.2.EU.9.r.1: Device Component name (free text)-->
        </kindOfMaterialKind>
      </asInstanceOfKind>
    </partDeviceInstance>
  </part>
</productInstanceInstance>

```

### ***1.C.3.7 Usage of nullflavor flags***

The HL7/ISO ICSR schema requires that mandatory data elements must always be part of the ICSR message and should not be empty. The optional elements as defined in the schema however should not be transmitted as empty elements.

In some situations mandatory data elements might be empty of content for specific reasons for an ICSR that is still considered valid. In HL7 messaging the issue of empty elements is handled through the use of a *nullflavor flags* these flags prevent a field being empty and provides the receiver of the ICSR with a reason for the lack of data. Therefore valid messages can be created containing mandatory elements without transmitting content. The reason for a blank element is referred to as the ‘flavor’ of the null value.

In the EU the ICH E2B(R3) IG is generally followed for the usage of nullflavor flags, however for specific data fields which are required in the EU for an ICSR to be considered valid nullflavor flags are not permitted. In addition there are situations where the use of a Nullflavor is required in the EU which is not foreseen in the ICH E2B(R3) IG.

The exceptions to ICH E2B(R3) IG are detailed in Table 29 below.

**Table 29 – Nullflavor flag- Exceptions to ICH E2B(R3)**

ICH E2B(R3) field	Description
C.2.r.4 - Qualification	The reporter qualification is mandatory for all reporters, the use of a nullflavor is not permitted
C.4.r.1 - Literature Reference(s)	For a report to be considered as a literature report the literature reference must be provided, the use of a nullflavor is not permitted
C.5.1.r.2 - Study Registration Country	In order to be able to identify EU registration numbers and the EudraCT number the study registration country code must be provided, the use of a nullflavor is not permitted
G.k.4.r.7 - Batch / Lot Number	The nullflavors "UNK" & "ASKU" should be provide for each reported suspect or interacting drug if no information is available.

In addition there are fields in the ICH E2B(R3) IG that foresee the use of the nullflavor "MSK" which indicates to the receiver of an ICSR that the sender of the ICSR holds this information but is unable to send this information due to data protection / privacy reasons. It is acknowledged that certain fields that can identify and individual such as the Patient name or initials D.1 (ICH E2B(R3)) or Date of Birth D.2.1 (ICH E2B(R3)) the "MSK" flag can be appropriate. However, in other E2B(R3) fields the use of the "MSK" flag is not considered valid for use in the EU as those fields would not lead to the direct identification of an individual.

The exceptions to ICH E2B(R3) IG are detailed in Table 30 below.

**Table 30 - Nullflavor "MSK" flag -Exceptions to the ICH E2B(R3) IG**

ICH E2B(R3) field code	ICH E2B(R3) field Description
D.5	Patient Sex
D.6	Patient Last Menstrual Period Date
D.7.1.r.2	Medical History Start Date
D.7.1.r.3	Medical History Continuing
D.7.1.r.4	Medical History End Date
D.7.2	Text for Relevant Medical History and Concurrent Conditions (not including reaction / event)
D.8.r.4	Relevant Past Drug History Start Date
D.8.r.5	Relevant Past Drug History End Date
D.9.1	Date of Death
D.10.3	Last Menstrual Period Date of Parent
D.10.6	Sex of Parent

ICH E2B(R3) field code	ICH E2B(R3) field Description
D.10.7.1.r.2	Relevant Medical History and Concurrent Conditions of Parent Start Date
D.10.7.1.r.3	Relevant Medical History and Concurrent Conditions of Parent Continuing
D.10.7.1.r.4	Relevant Medical History and Concurrent Conditions of Parent End Date
D.10.8.r.4	Relevant Past Drug History of Parent Start Date
D.10.8.r.5	Relevant Past Drug History of Parent End Date
E.i.4	Date of Start of Reaction / Event
E.i.5	Date of End of Reaction / Event
G.k.4.r.4	Date and Time of Start of Drug
G.k.4.r.5	Date and Time of Last Administration

### ***1.C.3.8 Characterisation of Drug Role “Drug Not Administered”***

According to the ICH E2B(R3) implementation guide ‘Drug not administered’ can be used in two circumstances:

- In clinical trials: if the adverse event occurred after the informed consent was signed but prior to the administration of the study drug (e.g. during the screening period or the washout procedure), the adverse event should in general be reported as per the trial procedure.
- Medication error: if the patient did not receive the actual prescribed drug but another one, repeatable Sections G should be completed with the information about the prescribed drug (selecting the characterisation of drug role as “Drug Not Administered”), as well as the information on the dispensed drug as the ‘suspect’ drug. The appropriate medication error LLT should be captured with the appropriate MedDRA LLT code for the associated reaction/event in Section e.i “*Reaction(s) / Event(s)*”.

The Medication error example is applicable for reporting in the EU as at least one suspect drug will be reported. However, for the clinical trial example in accordance with section 7.11.4 of the [Detailed guidance on the collection, verification and presentation of adverse event/reaction reports arising from clinical trials on medicinal products for human use \(‘CT-3’\)](#)<sup>8</sup>, this type of report should not be submitted as a SUSAR. A report providing no interacting or suspect drugs will be rejected.

### ***1.C.3.9 Literature references and the use of Digital Object Identifiers (DOI)***

In accordance with the ICH E2B(R3) implementation guide the literature reference provided in the field *C.4.r.1 Literature Reference(s)* should follow the ‘Vancouver style’, which has been developed by the International Committee of Medical Journal Editors. As part of this recommendation the Digital Object Identifier (DOI) for the article should be included where available. The example reference below highlighted how this should be done:

<sup>8</sup> [http://ec.europa.eu/health/files/eudralex/vol-10/2011\\_c172\\_01/2011\\_c172\\_01\\_en.pdf](http://ec.europa.eu/health/files/eudralex/vol-10/2011_c172_01/2011_c172_01_en.pdf)

International Committee of Medical Journal Editors. Uniform requirements for manuscripts submitted to biomedical journals. N Engl J Med 1997; 336:309-15. doi:10.1056/NEJM199701233360422

### ***I.C.3.10 MedDRA Version control***

A new release version of MedDRA should become the reporting version on the first Monday of the second month after it is released. To synchronize this event over the three ICH regions, the MSSO recommends midnight GMT, Sunday to Monday, for the switchover, for example:

The stated change over date and time need to be adhered to consistently by all stakeholders to avoid any disruptions with regard to the electronic exchange of ICSRs. MedDRA subscribers who are able to quickly update and validate their systems with each release of MedDRA should recognise that if they submit ICSRs using the updated MedDRA version prior to the receiving party, which has not switched to the updated version, the transmitted ICSRs will be rejected.

## I.C.4 Business Rules for E2B(R3) Message Processing

Table 31 below summarises the list of the business rules applicable to all submissions to EudraVigilance. Table 32 and Table 33 provide module specific business rules depending on the receiving system EVPM or EVCTM. These tables provide a list of all the rules generating error messages as described in section I.C.5.4. Figure 20 below provides the legend to Table 31, Table 32 and Table 33

**Figure 20 - Table Legend**

<b>Field ICH or EU:</b>	The value ICH indicates this field is part of the ICH E2B(R3) implementation guide
<b>Data Element:</b>	Element (or section) ID
<b>Field Name:</b>	Element (or section) name
<b>Max Length:</b>	Maximum number of characters or digits for an element
<b>Data Type:</b>	AN --> Alphanumeric N --> Numeric Boolean --> true/false Date/time
<b>Values:</b>	List of admissible values (if its exists)  (...) --> list of values [...] --> interval of values N.N --> MedDRA version
<b>Mandatory:</b>	Indicates that Element is mandatory, optional or conditional-mandatory. The term conditional-mandatory indicates that if certain conditions are met this field is mandatory.
<b>Notes:</b>	Further details provided on the business rule or look-up list applied to the field

**Table 31 - List of business rules applicable to all submissions to EudraVigilance**

Field Identification					Business rules		
Field ICH or EU	DATA ELEMENT	FIELD NAME	MAX LENGTH	DATA TYPE	VALUES	CONFORMANCE	NOTES
ICH	-	<b>ICH CSR Transmission Identification (batch wrapper)</b>	-	-	-	-	-
ICH	N.1.1	Types of Message in batch	2	N	ICH (1) EU [1-4]	Mandatory	See section I.C.3.1.1 Message Type for details on additional EU values
ICH_CSV	N.1.1.CSV	Types of Message in batch code system version	4	N	2.0	Mandatory	
ICH	N.1.2	Batch Number	100	AN	Free Text	Mandatory	
ICH	N.1.3	Batch Sender Identifier	60	AN	Registered Organisation ID	Mandatory	
ICH	N.1.4	Batch Receiver Identifier	60	AN	Registered Organisation ID	Mandatory	See note 6
ICH	N.1.5	Date of Batch Transmission	-	Date/Time	CCYYMMDDhhmmss[+/-ZZzz]	Mandatory	The full precision of date and time must be recorded down to the second. See note 5
ICH	-	<b>ICH ICSR Message Header (message wrapper) (Repeat as necessary)</b>	-	-	-	-	-
ICH	N.2.r.1	Message Identifier	100	AN	Free Text	Mandatory	Must be equal to C.1.1
ICH	N.2.r.2	Message Sender Identifier	60	AN	Registered Organisation ID	Mandatory	
ICH	N.2.r.3	Message Receiver Identifier	60	AN	Registered Organisation ID	Mandatory	See note 6
ICH	N.2.r.4	Date of Message Creation	-	Date/Time	CCYYMMDDhhmmss[+/-ZZzz]	Mandatory	The full precision of date and time must be recorded down to the second. See note 5
ICH	-	<b>Identification of the Case Safety Report</b>	-	-	-	-	-
ICH	C.1.1	Sender's (case) Safety Report Unique Identifier	100	AN	Free Text	Mandatory	valid (ISO 3166-1 alpha-2, including value EU) country code-regulator or company name-report number. See



							note 10 & 12
ICH	C.1.2	Date of Creation	-	Date/Time	CCYYMMDDhhmmss[+/-ZZzz]	Mandatory	The full precision of date and time must be recorded down to the second. See note 5
ICH	C.1.3	Type of Report	1	N	[1-4]	Mandatory	For submissions to EVCTM value must = 2. See note 2
ICH_CSV	C.1.3.CSV	Type of Report Code system version	4	N	2.0	Mandatory	
ICH	C.1.4	Date Report Was First Received from Source	-	Date/Time	CCYYMMDD (Minimum)	Mandatory	Minimum precision required is the day (i.e. 'CCYYMMDD'). See note 5, should be ≤ to C.1.5.
ICH	C.1.5	Date of Most Recent Information for This Report	-	Date/Time	CCYYMMDD (Minimum)	Mandatory	Minimum precision required is the day (i.e. 'CCYYMMDD'). See note 5, should be ≥ to C.1.4.
ICH	C.1.6.1	Are Additional Documents Available?	-	Boolean	-	Mandatory	
ICH	-	<b>Identification of the Case Safety Report</b>	-	-	-	-	-
ICH	C.1.6.1.r.1	Documents Held by Sender	2000	AN	Free Text	Conditional-Mandatory	Mandatory if C.1.6.1 = 'true' or if C.1.6.1r.2 contains a file
ICH	C.1.6.1.r.2	Included Documents	-	N/A	N/A	Optional	Embedded document e.g. PDF, Binary files attachments should be provided as base 64 using the deflate compression algorithm. See note 13
-	-	-	-	-	-	-	-
ICH	C.1.7	Does This Case Fulfil the Local Criteria for an Expedited Report?	-	Boolean	-	Mandatory	
ICH	C.1.8.1	Worldwide Unique Case Identification	100	AN	Free Text	Mandatory	valid (ISO 3166-1 alpha-2, including value EU) country code-regulator or company name-report number. See note 10 & 12
ICH	C.1.8.2	First Sender of This Case	1	N	(1,2)	Mandatory	

ICH_CSV	C.1.8.2.CSV	First Sender of This Case Code system version	4	N	2.0	Mandatory	
ICH	C.1.9.1	Other Case Identifiers in Previous Transmissions	-	Boolean	-	Mandatory	
ICH	-	<b>Source(s) of the Case Identifier(s) (repeat as necessary)</b>	-	-	-	-	-
ICH	C.1.9.1.r.1	Source(s) of the Case Identifier	100	AN	Free Text	Conditional-Mandatory	Mandatory if C.1.9.1= 'true'.
ICH	C.1.9.1.r.2	Case Identifier(s)	100	AN	Free Text	Conditional-Mandatory	Mandatory if C.1.9.1= 'true'.
ICH	-	<b>Identification Number of the Report Which Is Linked to This Report (repeat as necessary)</b>	-	-	-	-	-
ICH	C.1.10.r	Identification Number of the Report Which Is Linked to This Report	100	AN	Free Text	Optional	valid (ISO 3166-1 alpha-2, including value EU) country code-regulator or company name-report number See note 12
-	-	-	-	-	-	-	-
ICH	C.1.11.1	Report Nullification / Amendment	1	N	(1,2)	Optional	See note 7
ICH_CSV	C.1.11.1.CSV	Report Nullification / Amendment Code system version	4	N	2.0	Conditional-Mandatory	CSV should be provided with C.1.11.1
ICH	C.1.11.2	Reason for Nullification / Amendment	2000	AN	Free Text	Conditional-Mandatory	Mandatory if C.1.11.1 is populated
ICH	-	<b>Primary Source(s) of Information (repeat as necessary)</b>	-	-	-	-	-
ICH	C.2.r.1.1	Reporter's Title	50	AN	Free Text	Optional	
ICH	C.2.r.1.2	Reporter's Given Name	60	AN	Free Text	Optional	
ICH	C.2.r.1.3	Reporter's Middle Name	60	AN	Free Text	Optional	
ICH	C.2.r.1.4	Reporter's Family Name	60	AN	Free Text	Optional	
ICH	C.2.r.2.1	Reporter's Organisation	60	AN	Free Text	Optional	

ICH	C.2.r.2.2	Reporter's Department	60	AN	Free Text	Optional	
ICH	C.2.r.2.3	Reporter's Street	100	AN	Free Text	Optional	
ICH	C.2.r.2.4	Reporter's City	35	AN	Free Text	Optional	
ICH	C.2.r.2.5	Reporter's State or Province	40	AN	Free Text or Code list	Conditional-Mandatory	Mandatory for cases originating in Spain using the code list, see note 8
ICH	C.2.r.2.6	Reporter's Postcode	15	AN	Free Text	Optional	
ICH	C.2.r.2.7	Reporter's Telephone	33	AN	Free Text	Optional	
ICH	C.2.r.3	Reporter's Country Code	2	A	ISO 3166-1 alpha-2, value EU not accepted	Conditional-Mandatory	Mandatory (nullflavor flag not accepted) if C.2.r.5 = 1. The value EU is not valid for this field
ICH	C.2.r.4	Qualification	1	N	[1-5]	Mandatory	Nullflavor not permitted
ICH_CSV	C.2.r.4.CSV	Qualification code system version	4	N	2.0	Mandatory	
ICH	C.2.r.5	Primary Source for Regulatory Purposes	1	N	(1)	Conditional-Mandatory	Mandatory for one and only one instance of this element.
ICH	-	<b>Information on Sender of Case Safety Report</b>	-	-	-	-	-
ICH	C.3.1	Sender Type	1	N	[1-7]	Mandatory	
ICH_CSV	C.3.1.CSV	Sender Type code system version	4	n	2.0	Mandatory	
ICH	C.3.2	Sender's Organisation	100	AN	Free Text	Conditional-Mandatory	Mandatory if C.3.1 = [1-2]
ICH	C.3.3.1	Sender's Department	60	AN	Free Text	Optional	
ICH	C.3.3.2	Sender's Title	50	AN	Free Text	Optional	
ICH	C.3.3.3	Sender's Given Name	60	AN	Free Text	Optional	
ICH	C.3.3.4	Sender's Middle Name	60	AN	Free Text	Optional	
ICH	C.3.3.5	Sender's Family Name	60	AN	Free Text	Optional	
ICH	C.3.4.1	Sender's Street Address	100	AN	Free Text	Optional	
ICH	C.3.4.2	Sender's City	35	AN	Free Text	Optional	
ICH	C.3.4.3	Sender's State or Province	40	AN	Free Text	Optional	
ICH	C.3.4.4	Sender's Postcode	15	AN	Free Text	Optional	

ICH	C.3.4.5	Sender's Country Code	2	AN	ISO 3166-1 alpha-2, including value EU	Optional	
ICH	C.3.4.6	Sender's Telephone	33	AN	Free Text	Optional	
ICH	C.3.4.7	Sender's Fax	33	AN	Free Text	Optional	
ICH	C.3.4.8	Sender's E-mail Address	100	AN	Free Text	Optional	
ICH	-	<b>Literature Reference(s) (repeat as necessary)</b>	-	-	-	-	-
ICH	C.4.r.1	Literature Reference(s)	500	AN	Free Text	Conditional-Mandatory	Mandatory if C.4.r.1 contains an embedded document Vancouver Style
ICH	C.4.r.2	Included Documents	-	N/A	N/A	Optional	Embedded document e.g. PDF, Binary files attachments should be provided as base 64 using the deflate compression algorithm. See note 13
-	-	<b>Study Identification</b>	-	-	-	-	-
ICH	-	<b>Study Registration (repeat as necessary)</b>	-	-	-	-	-
ICH	C.5.1.r.1	Study Registration Number	50	AN	Free Text or EudraCT number	Conditional-Mandatory	Applies to transmissions to EVCTM: Must be a valid EudraCT number if C.5.1.r.2 = "EU", Null flag not accepted. See note 4
ICH	C.5.1.r.2	Study Registration Country	2	A	ISO 3166-1 alpha-2, including value EU	Conditional-Mandatory	Applies to transmissions to EVCTM: Mandatory when the case originates in the EU at least one iteration must have the value "EU". See note 4
-	-	-	-	-	-	-	-
ICH	C.5.2	Study Name	2000	AN	Free Text	Conditional-Mandatory	Applies to transmissions to EVCTM: This field is Mandatory (i.e. must contain text, Nullflavor flag not accepted). See note 4
ICH	C.5.3	Sponsor Study Number	50	AN	Free Text	Optional	

ICH	C.5.4	Study Type Where Reaction(s) / Event(s) Were Observed	1	N	[1-3]	Conditional-Mandatory	Mandatory if C.1.3 = 2. Value must be 1 for any transmission to EVCTM Only values [2-3] are accepted by EVHUMAN See note 2 and 4
ICH_CSV	C.5.4.CSV	Study Type Where Reaction(s) / Event(s) Were Observed code system version	4	N	2.0	Conditional-Mandatory	CSV should be provided with C.5.4
ICH	-	<b>Patient Characteristics</b>	-	-	-	-	-
ICH	D.1	Patient (name or initials)	60	AN	Free Text	Conditional-Mandatory	At least one of D.1, D.1.1.1, D.1.1.2, D.1.1.3, D.1.1.4, D.2.1, D.2.2A, D.2.2.1a, D.2.3 or D.5. See note 9
ICH	D.1.1.1	Patient Medical Record Number(s) and Source(s) of the Record Number (GP Medical Record Number)	20	AN	Free Text	Conditional-Mandatory	At least one of D.1, D.1.1.1, D.1.1.2, D.1.1.3, D.1.1.4, D.2.1, D.2.2A, D.2.2.1a, D.2.3 or D.5. See note 9
ICH	D.1.1.2	Patient Medical Record Number(s) and Source(s) of the Record Number (Specialist Record Number)	20	AN	Free Text	Conditional-Mandatory	At least one of D.1, D.1.1.1, D.1.1.2, D.1.1.3, D.1.1.4, D.2.1, D.2.2A, D.2.2.1a, D.2.3 or D.5. See note 9
ICH	D.1.1.3	Patient Medical Record Number(s) and Source(s) of the Record Number (Hospital Record Number)	20	AN	Free Text	Conditional-Mandatory	At least one of D.1, D.1.1.1, D.1.1.2, D.1.1.3, D.1.1.4, D.2.1, D.2.2A, D.2.2.1a, D.2.3 or D.5. See note 9
ICH	D.1.1.4	Patient Medical Record Number(s) and Source(s) of the Record Number (Investigation Number)	20	AN	Free Text	Conditional-Mandatory	At least one of D.1, D.1.1.1, D.1.1.2, D.1.1.3, D.1.1.4, D.2.1, D.2.2A, D.2.2.1a, D.2.3 or D.5. See note 9
ICH	-	<b>Age Information</b>	-	-	-	-	-
ICH	D.2.1	Date of Birth	-	Date/Time	CCYYMMDD (Minimum)	Conditional-Mandatory	Minimum precision required is the day (i.e. 'CCYYMMDD'). At least one of D.1, D.1.1.1, D.1.1.2, D.1.1.3, D.1.1.4, D.2.1, D.2.2A, D.2.2.1a, D.2.3 or

							D.5. See note 5 & 9
ICH	D.2.2a	Age at Time of Onset of Reaction / Event (number)	5	N	Numeric	Conditional-Mandatory	Mandatory if D.2.2b is populated. Should not be > 150 years. See note 3 At least one of D.1, D.1.1.1, D.1.1.2, D.1.1.3, D.1.1.4, D.2.1, D.2.2A, D.2.2.1a, D.2.3 or D.5 See note 9
ICH	D.2.2b	Age at Time of Onset of Reaction / Event (unit)	50	AN	UCUM Year, Month, Week, Day, Hour and Decade	Conditional-Mandatory	Mandatory if D.2.2a is populated
ICH	D.2.2.1a	Gestation Period When Reaction / Event Was Observed in the Foetus (number)	3	N	Numeric	Conditional-Mandatory	Mandatory if D.2.2.1b is populated. At least one of D.1, D.1.1.1, D.1.1.2, D.1.1.3, D.1.1.4, D.2.1, D.2.2A, D.2.2.1a, D.2.3 or D.5
ICH	D.2.2.1b	Gestation Period When Reaction/Event Was Observed in the Foetus (unit)	50	AN	UCUM Month, Week, Day and {Trimester}	Conditional-Mandatory	Mandatory if D.2.2.1a is populated
ICH	D.2.3	Patient Age Group (as per reporter)	1	N	[0-6]	Conditional-Mandatory	At least one of D.1, D.1.1.1, D.1.1.2, D.1.1.3, D.1.1.4, D.2.1, D.2.2A, D.2.2.1a, D.2.3 or D.5 See note 9
ICH_CSV	D.2.3.CSV	Patient Age Group (as per reporter) code system version	4	N	2.0	Conditional-Mandatory	CSV should be provided with D.2.3
-	-	-	-	-	-	-	-
ICH	D.3	Body Weight (kg)	6	N	Numeric	Optional	Should not be > 650 kg. See note 3, Numeric values and the decimal point only
ICH	D.4	Height (cm)	3	N	Numeric	Optional	Should not be > 250 cm. See note 3, whole numbers only
ICH	D.5	Sex	1	N	(1,2)	Conditional-Mandatory	At least one of D.1, D.1.1.1, D.1.1.2, D.1.1.3, D.1.1.4, D.2.1, D.2.2A, D.2.2.1a, D.2.3 or D.5

ICH	D.6	Last Menstrual Period Date	-	Date/Time	CCYY (Minimum)	Optional	See note 5
ICH	-	<b>Structured Information on Relevant Medical History (repeat as necessary)</b>	-	-	-	-	-
ICH	D.7.1.r.1a	MedDRA Version for Medical History	4	AN	N.N	Conditional-Mandatory	Mandatory if D.7.1.r.1b is populated. Numeric values and the decimal point only. See note 1
ICH	D.7.1.r.1b	Medical History (disease / surgical procedure / etc.) (MedDRA code)	8	N	MedDRA	Conditional-Mandatory	Mandatory if D.7.1.r.1a is populated.
ICH	D.7.1.r.2	Start Date	-	Date/Time	CCYY (Minimum)	Optional	Minimum precision required is the year (i.e. 'CCYY'). Should precede or equal D.7.1.r.4. See note 5
ICH	D.7.1.r.3	Continuing	-	Boolean	-	Optional	
ICH	D.7.1.r.4	End Date	-	Date/Time	CCYY (Minimum)	Optional	Minimum precision required is the year (i.e. 'CCYY'). Should be greater or equal to D.7.1.r.2. See note 5
ICH	D.7.1.r.5	Comments	2000	AN	Free Text	Optional	
ICH	D.7.1.r.6	Family History	-	Boolean	-	Optional	
-	-	-	-	-	-	-	-
ICH	D.7.2	Text for Relevant Medical History and Concurrent Conditions (not including reaction / event)	10000	AN	Free Text	Optional	
ICH	D.7.3	Concomitant Therapies	-	Boolean	-	Optional	
ICH	-	<b>Relevant Past Drug History (repeat as necessary)</b>	-	-	-	-	-
ICH	D.8.r.1	Name of Drug as Reported	250	AN	Free Text	Conditional-Mandatory	Mandatory when this section is provided
EU	D.8.r.1.EU.1	Name part - Invented name	1000	AN	Free Text	Optional	
EU	D.8.r.1.EU.2	Name part - Scientific name	1000	AN	Free Text	Optional	

EU	D.8.r.1.EU.3	Name part - Trademark name	1000	AN	Free Text	Optional	
EU	D.8.r.1.EU.4	Name part - Strength name	1000	AN	Free Text	Optional	
EU	D.8.r.1.EU.5	Name part - Form name	1000	AN	Free Text	Optional	
EU	D.8.r.1.EU.6	Name part - Container name	1000	AN	Free Text	Optional	
EU	D.8.r.1.EU.7	Name part - Device name	1000	AN	Free Text	Optional	
EU	D.8.r.1.EU.8	Name part - Intended use name	1000	AN	Free Text	Optional	
ICH	D.8.r.2a	MPID Version Date/Number	10	AN	Free Text	Conditional-Mandatory	Mandatory if D.8.r.2b is populated
ICH	D.8.r.2b	Medicinal Product Identifier (MPID)	250	AN	MPID	Conditional-Mandatory	Mandatory if D.8.r.2a is populated
ICH	D.8.r.3a	PhPID Version Date/Number	10	AN	Free Text	Conditional-Mandatory	Mandatory if D.8.r.3b is populated
ICH	D.8.r.3b	Pharmaceutical Product Identifier (PhPID)	1000	AN	PhPID	Conditional-Mandatory	Mandatory if D.8.r.3a is populated
EU	-	<b>Substance / Specified Substance Identifier and Strength (repeat as necessary)</b>	-	-	-	-	-
EU	D.8.r.EU.r.1	Substance / Specified Substance Name	250	AN	Free Text	Conditional-Mandatory	If the section D.8.r.EU.r is provided the Substance name must be provided
EU	D.8.r.EU.r.2a	Substance/Specified Substance TermID Version Date/Number	10	AN	Free Text	Conditional-Mandatory	Mandatory if D.8.r.EU.r.2b is populated
EU	D.8.r.EU.r.2b	Substance/Specified Substance TermID	100	AN	SubstanceID	Conditional-Mandatory	Mandatory if D.8.r.EU.r.2a is populated
EU	D.8.r.EU.r.3a	Strength (number)	10	N	Numeric	Conditional-Mandatory	Mandatory if G.k.2.3.r.3b is populated
EU	D.8.r.EU.r.3b	Strength (unit)	50	AN	UCUM	Conditional-Mandatory	Mandatory if G.k.2.3.r.3a is populated. See note 11
-	-	-	-	-	-	-	-
ICH	D.8.r.4	Start Date	-	Date/Time	CCYY (Minimum)	Optional	Minimum precision required is the year (i.e. 'CCYY'). Should precede or be equal to D.8.r.5. See note 5



ICH	D.8.r.5	End Date	-	Date/Time	CCYY (Minimum)	Optional	Minimum precision required is the year (i.e. 'CCYY'). Should be greater or be equal to D.8.r.4. See note 5
ICH	D.8.r.6a	MedDRA Version for Indication	4	AN	N.N	Conditional-Mandatory	Mandatory if D.8.r.6b is populated. Numeric values and the decimal point only. See note 5
ICH	D.8.r.6b	Indication (MedDRA code)	8	N	MedDRA	Conditional-Mandatory	Mandatory if D.8.r.6a is populated
ICH	D.8.r.7a	MedDRA Version for Reaction	4	AN	N.N	Conditional-Mandatory	Mandatory if D.8.r.7b is populated. Numeric values and the decimal point only. See note 5
ICH	D.8.r.7b	Reaction (MedDRA code)	8	N	MedDRA	Conditional-Mandatory	Mandatory if D.8.r.7a is populated
-	-	-	-	-	-	-	-
ICH	D.9.1	Date of Death	-	Date/Time	CCYY (Minimum)	Optional	Minimum precision required is the year (i.e. 'CCYY'). See note 5
ICH	-	<b>Reported Cause(s) of Death (repeat as necessary)</b>	-	-	-	-	-
ICH	D.9.2.r.1a	MedDRA Version for Reported Cause(s) of Death	4	AN	N.N	Conditional-Mandatory	Mandatory if D.9.2.r.1b is populated. Numeric values and the decimal point only. See note 1
ICH	D.9.2.r.1b	Reported Cause(s) of Death (MedDRA code)	8	N	MedDRA	Conditional-Mandatory	Mandatory if D.9.2.r.1a is populated
ICH	D.9.2.r.2	Reported Cause(s) of Death (free text)	250	AN	Free Text	Optional	
-	-	-	-	-	-	-	-
ICH	D.9.3	Was Autopsy Done?	-	Boolean	-	Conditional-Mandatory	Mandatory if D.9.1 has been completed
ICH	-	<b>Autopsy-determined Cause(s) of Death (repeat as necessary)</b>	-	-	-	-	-
ICH	D.9.4.r.1a	MedDRA Version for Autopsy-determined Cause(s) of Death	4	AN	N.N	Conditional-Mandatory	Mandatory if D.9.4.r.1b is populated. Numeric values and the decimal point only. See note 1

ICH	D.9.4.r.1b	Autopsy-determined Cause(s) of Death (MedDRA code)	8	N	MedDRA	Conditional-Mandatory	Mandatory if D.9.4.r.1a is populated
ICH	D.9.4.r.2	Autopsy-determined Cause(s) of Death (free text)	250	AN	Free Text	Optional	
ICH	-	<b>For a Parent-Child / Foetus Report, Information Concerning The Parent</b>	-	-	-	-	-
ICH	D.10.1	Parent Identification	60	AN	Free Text	Optional	
ICH	D.10.2.1	Date of Birth of Parent	-	Date/Time	CCYY (Minimum)	Optional	Minimum precision required is the year (i.e. 'CCYY'). See note 5
ICH	D.10.2.2a	Age of Parent (number)	3	N	Numeric	Conditional-Mandatory	Required if D.10.2.2b is populated. Should not be >150 years. See note 3
ICH	D.10.2.2b	Age of Parent (unit)	50	AN	UCUM	Conditional-Mandatory	Required if D.10.2.2a is populated. See note 3
ICH	D.10.3	Last Menstrual Period Date of Parent	-	Date/Time	CCYY (Minimum)	Optional	Minimum precision required is the year (i.e. 'CCYY'). Should be NULL if B.1.10.6 value is (1) (parent is male). See note 5
ICH	D.10.4	Body Weight (kg) of Parent	6	N	Numeric	Optional	If not null, should not be > 650 kg. Numeric values and the decimal point only. See note 3
ICH	D.10.5	Height (cm) of Parent	3	N	Numeric	Optional	If not null, should not be > 250 cm. Whole numbers (integers) only See note 3
ICH	D.10.6	Sex of Parent	1	N	(1,2)	Optional	
ICH	-	<b>Relevant Medical History and Concurrent Conditions of Parent</b>	-	-	-	-	-
ICH	-	<b>Structured Information of Parent (repeat as necessary)</b>	-	-	-	-	-
ICH	D.10.7.1.r.1a	MedDRA Version for Medical History	4	AN	N.N	Conditional-Mandatory	Mandatory if D.10.7.1.r.1b is populated. Numeric values and the decimal point only. See note 1

ICH	D.10.7.1.r.1b	Medical History (disease / surgical procedure / etc.) (MedDRA code)	8	N	MedDRA	Conditional-Mandatory	Mandatory if D.10.7.1.r.1a is populated
ICH	D.10.7.1.r.2	Start Date	-	Date/Time	CCYY (Minimum)	Optional	Minimum precision required is the year (i.e. 'CCYY'). Should precede or be equal to D.10.7.1.r.4. See note 5
ICH	D.10.7.1.r.3	Continuing	-	Boolean	-	Optional	
ICH	D.10.7.1.r.4	End Date	-	Date/Time	CCYY (Minimum)	Optional	Minimum precision required is the year (i.e. 'CCYY'). Should be greater or equal to D.10.7.1.r.2. See note 5
ICH	D.10.7.1.r.5	Comments	2000	AN	Free Text	Optional	
-	-	-	-	-	-	-	-
ICH	D.10.7.2	Text for Relevant Medical History and Concurrent Conditions of Parent	10000	AN	Free Text	Optional	
ICH	-	<b>Relevant Past Drug History of Parent (repeat as necessary)</b>	-	-	-	-	-
ICH	D.10.8.r.1	Name of Drug as Reported	250	AN	Free Text	Conditional-Mandatory	Mandatory when this section is provided
EU	D.10.8.r.1.EU.1	Name part - Invented name	1000	AN	Free Text	Optional	
EU	D.10.8.r.1.EU.2	Name part - Scientific name	1000	AN	Free Text	Optional	
EU	D.10.8.r.1.EU.3	Name part - Trademark name	1000	AN	Free Text	Optional	
EU	D.10.8.r.1.EU.4	Name part - Strength name	1000	AN	Free Text	Optional	
EU	D.10.8.r.1.EU.5	Name part - Form name	1000	AN	Free Text	Optional	
EU	D.10.8.r.1.EU.6	Name part - Container name	1000	AN	Free Text	Optional	
EU	D.10.8.r.1.EU.7	Name part - Device name	1000	AN	Free Text	Optional	
EU	D.10.8.r.1.EU.8	Name part - Intended use name	1000	AN	Free Text	Optional	

ICH	D.10.8.r.2a	MPID Version Date/Number	10	AN	Free Text	Conditional-Mandatory	Mandatory if D.10.8.r.2b is populated
ICH	D.10.8.r.2b	Medicinal Product Identifier (MPID)	1000	AN	MPID	Conditional-Mandatory	Mandatory if D.10.8.r.2a is populated
ICH	D.10.8.r.3a	PhPID Version Date/Number	10	AN	Free Text	Conditional-Mandatory	Mandatory if D.10.8.r.3b is populated
ICH	D.10.8.r.3b	Pharmaceutical Product Identifier (PhPID)	250	AN	PhPID	Conditional-Mandatory	Mandatory if D.10.8.r.3a is populated
EU	-	<b>Substance / Specified Substance Identifier and Strength (repeat as necessary)</b>	-	-	-	-	-
EU	D.10.8.r.EU.r.1	Substance / Specified Substance Name	250	AN	Free Text	Conditional-Mandatory	If the section D.10.8.r.EU.r is provided the Substance name must be provided
EU	D.10.8.r.EU.r.2a	Substance/Specified Substance TermID Version Date/Number	10	AN	Free Text	Conditional-Mandatory	Mandatory if D.10.8.r.EU.r.2b is populated
EU	D.10.8.r.EU.r.2b	Substance/Specified Substance TermID	100	AN	SubstanceID	Conditional-Mandatory	Mandatory if D.10.8.r.EU.r.2a is populated
EU	D.10.8.r.EU.r.3a	Strength (number)	10	N	Numeric	Conditional-Mandatory	Mandatory if D.10.8.r.EU.r.3b is populated
EU	D.10.8.r.EU.r.3b	Strength (unit)	50	AN	UCUM	Conditional-Mandatory	Mandatory if D.10.8.r.EU.r.3a is populated. See note 11
-	-	-	-	-	-	-	-
ICH	D.10.8.r.4	Start Date	-	Date/Time	CCYY (Minimum)	Optional	Minimum precision required is the year (i.e. 'CCYY'). Should precede D.10.8.r.5. See note 5
ICH	D.10.8.r.5	End Date	-	Date/Time	CCYY (Minimum)	Optional	Minimum precision required is the year (i.e. 'CCYY'). Should be greater or equal to D.10.8.r.4. See note 5
ICH	D.10.8.r.6a	MedDRA Version for Indication	4	AN	N.N	Conditional-Mandatory	Mandatory if D.10.8.r.6b is populated. Numeric values and the decimal point only. See note 1
ICH	D.10.8.r.6b	Indication (MedDRA code)	8	N	MedDRA	Conditional-Mandatory	Mandatory if D.10.8.r.6a is populated. See note 1

ICH	D.10.8.r.7a	MedDRA Version for Reaction	4	AN	N.N	Conditional-Mandatory	Mandatory if D.10.8.r.7b is populated. Numeric values and the decimal point only. See note 1
ICH	D.10.8.r.7b	Reactions (MedDRA code)	8	N	MedDRA	Conditional-Mandatory	Mandatory if D.10.8.r.7a is populated. See note 1
ICH	-	<b>Reaction(s)/Event(s) (repeat as necessary)</b>	-	-	-	-	-
ICH	E.i.1.1a	Reaction / Event as Reported by the Primary Source in Native Language	250	AN	Free Text	Optional	
ICH	E.i.1.1b	Reaction / Event as Reported by the Primary Source Language	3	A	ISO 639-2/RA, alpha-3	Conditional-Mandatory	Mandatory if E.i.1.1a is populated
ICH	E.i.1.2	Reaction / Event as Reported by the Primary Source for Translation	250	AN	Free Text	Optional	
ICH	E.i.2.1a	MedDRA Version for Reaction / Event	4	AN	N.N	Mandatory	Numeric values and the decimal point only. See note 1
ICH	E.i.2.1b	Reaction / Event (MedDRA code)	8	N	MedDRA	Mandatory	See note 1
ICH	E.i.3.1	Term Highlighted by the Reporter	1	N	(1,2,3,4)	Optional	
ICH_CSV	E.i.3.1.CSV	Term Highlighted by the Reporter code system version	4	N	2.0	Conditional-Mandatory	CSV should be provided with E.i.3.1
ICH	E.i.3.2a	Results in Death	-	Boolean	-	Mandatory	Must be "True" when E.i.7 = 5.
ICH	E.i.3.2b	Life Threatening	-	Boolean	-	Mandatory	
ICH	E.i.3.2c	Caused / Prolonged Hospitalisation	-	Boolean	-	Mandatory	
ICH	E.i.3.2d	Disabling / Incapacitating	-	Boolean	-	Mandatory	
ICH	E.i.3.2e	Congenital Anomaly / Birth Defect	-	Boolean	-	Mandatory	
ICH	E.i.3.2f	Other Medically Important Condition	-	Boolean	-	Mandatory	
ICH	E.i.4	Date of Start of Reaction / Event	-	Date/Time	CCYY (Minimum)	Optional	Minimum precision required is the year (i.e. 'CCYY'). Should precede or be equal to E.i.5. See note 5

ICH	E.i.5	Date of End of Reaction / Event	-	Date/Time	CCYY (Minimum)	Optional	Minimum precision required is the year (i.e. 'CCYY'). Should be greater or equal to E.i.4. See note 5
ICH	E.i.6a	Duration of Reaction / Event (number)	5	N	Numeric	Conditional-Mandatory	Mandatory if E.i.6b is populated
ICH	E.i.6b	Duration of Reaction / Event (unit)	50	AN	UCUM	Conditional-Mandatory	Mandatory if E.i.6a is populated
ICH	E.i.7	Outcome of Reaction / Event at the Time of Last Observation	1	N	[0-5]	Mandatory	Must be the value 5 if E.i.3.2a = "True"
ICH_CSV	E.i.7.CSV	Outcome of Reaction / Event at the Time of Last Observation code system version	4	N	2.0	Conditional-Mandatory	CSV should be provided with E.1.7
ICH	E.i.8	Medical Confirmation by Healthcare Professional	-	Boolean	-	Optional	
ICH	E.i.9	Identification of the Country Where the Reaction / Event Occurred	2	A	ISO 3166-1 alpha-2, including value EU	Optional	
ICH	-	<b>Results of Tests and Procedures Relevant to the Investigation of the Patient (repeat as necessary)</b>	-	-	-	-	-
ICH	F.r.1	Test Date	-	Date/Time	CCYY (Minimum)	Conditional-Mandatory	Mandatory if F.r.2.2b or F.r.2.1 Is populated. Minimum precision required is the year (i.e. 'CCYY'). See note 5
ICH	F.r.2.1	Test Name (free text)	250	AN	Free Text	Optional	
ICH	F.r.2.2a	MedDRA Version for Test Name	4	AN	N.N	Conditional-Mandatory	Mandatory if F.r.2.2b is populated. Numeric values and the decimal point only. See note 1
ICH	F.r.2.2b	Test Name (MedDRA code)	8	N	MedDRA	Conditional-Mandatory	Mandatory if F.r.2.2a is populated or if F.r.1 is populated
ICH	F.r.3.1	Test Result (code)	1	N	[1-4]	Conditional-Mandatory	Mandatory if F.r.2.2b is populated, and neither F.r.3.2 nor F.r.3.4 is not populated.

							See note 14
ICH_CSV	F.r.3.1.CSV	Test Result (code) code system version	4	N	2.0	Conditional-Mandatory	CSV should be provided with F.r.3.1
ICH	F.r.3.2	Test Result (value / qualifier)	50	N	Free Text	Conditional-Mandatory	Mandatory if F.r.2.2b is populated, and neither F.r.3.1 nor F.r.3.4 is not populated See note 14
ICH	F.r.3.3	Test Result (unit)	50	AN	UCUM	Conditional-Mandatory	Mandatory if F.r.3.2 is populated. See note 11
ICH	F.r.3.4	Result Unstructured Data (free text)	2000	AN	Free Text	Conditional-Mandatory	Mandatory if F.r.2.2b is populated, and neither F.r.3.1 nor F.r.3.2 is not populated See note 14
ICH	F.r.4	Normal Low Value	50	AN	Free Text	Optional	
ICH	F.r.5	Normal High Value	50	AN	Free Text	Optional	
ICH	F.r.6	Comments (free text)	2000	AN	Free Text	Optional	
ICH	F.r.7	More Information Available	-	Boolean	-	Optional	
ICH	-	<b>Drug(s) Information (repeat as necessary)</b>	-	-	-	-	-
ICH	G.k.1	Characterisation of Drug Role	1	N	[1-4]	Mandatory	At least one iteration must have the value 1 or 3
ICH_CSV	G.k.1.CSV	Characterisation of Drug Role code system version	4	N	2.0	Conditional-Mandatory	CSV should be provided with G.k.1
ICH	G.k.2.1.1a	MPID Version Date / Number	10	AN	Free Text	Conditional-Mandatory	Mandatory if G.k.2.1.1b is populated
ICH	G.k.2.1.1b	Medicinal Product Identifier (MPID)	1000	AN	MPID	Conditional-Mandatory	Mandatory if G.k.2.1.1a is populated
ICH	G.k.2.1.2a	PhPID Version Date/Number	10	AN	Free Text	Conditional-Mandatory	Mandatory if G.k.2.1.2b is populated
ICH	G.k.2.1.2b	Pharmaceutical Product Identifier (PhPID)	250	AN	PhPID	Conditional-Mandatory	Mandatory if G.k.2.1.2a is populated
ICH	G.k.2.2	Medicinal Product Name as Reported by the Primary Source	250	AN	Free Text	Mandatory	
EU	G.k.2.2.EU.1	Name part - Invented name	1000	AN	Free Text	Optional	

EU	G.k.2.2.EU.2	Name part - Scientific name	1000	AN	Free Text	Optional	
EU	G.k.2.2.EU.3	Name part - Trademark name	1000	AN	Free Text	Optional	
EU	G.k.2.2.EU.4	Name part - Strength name	1000	AN	Free Text	Optional	
EU	G.k.2.2.EU.5	Name part - Form name	1000	AN	Free Text	Optional	
EU	G.k.2.2.EU.6	Name part - Container name	1000	AN	Free Text	Optional	
EU	G.k.2.2.EU.7	Name part - Device name	1000	AN	Free Text	Optional	
EU	G.k.2.2.EU.8	Name part - Intended use name	1000	AN	Free Text	Optional	
EU	-	<b>Device component (repeat as necessary)</b>	-	-	-	-	-
EU	G.k.2.2.EU.9.r.1	Device Component name (free text)	250	AN	Free Text	Optional	
EU	G.k.2.2.EU.9.r.2	Device Component TermID version Date/Number	10	AN	Free Text	Conditional-Mandatory	Mandatory if G.k.2.2.EU.9.r.3 is populated
EU	G.k.2.2.EU.9.r.3	Device Component TermID	100	AN	DeviceID	Conditional-Mandatory	Mandatory if G.k.2.2.EU.9.r.2 is populated
EU	G.k.2.2.EU.9.r.4	Device Batch Lot number	35	AN	Free Text	Optional	
ICH	-	<b>Substance / Specified Substance Identifier and Strength (repeat as necessary)</b>	-	-	-	-	-
ICH	G.k.2.3.r.1	Substance / Specified Substance Name	250	AN	Free Text	Conditional-Mandatory	If the section G.k.2.3.r is provided the Substance name must be provided
ICH	G.k.2.3.r.2a	Substance/Specified Substance TermID Version Date/Number	10	AN	Free Text	Conditional-Mandatory	Mandatory if G.k.2.3.r.2b is populated
ICH	G.k.2.3.r.2b	Substance/Specified Substance TermID	100	AN	SubstanceID	Conditional-Mandatory	Mandatory if G.k.2.3.r.2a is populated
ICH	G.k.2.3.r.3a	Strength (number)	10	N	Numeric	Conditional-Mandatory	Mandatory if G.k.2.3.r.3b is populated
ICH	G.k.2.3.r.3b	Strength (unit)	50	AN	UCUM	Conditional-Mandatory	Mandatory if G.k.2.3.r.3a is populated. See note 11



-	-	-	-	-	-	-	-
ICH	G.k.2.4	Identification of the Country Where the Drug Was Obtained	2	A	ISO 3166-1 alpha-2, including value EU	Optional	
ICH	G.k.2.5	Investigational Product Blinded	-	Boolean	-	Optional	
ICH	G.k.3.1	Authorisation / Application Number	35	AN	Free Text	Optional	
ICH	G.k.3.2	Country of Authorisation / Application	2	A	ISO 3166-1 alpha-2, including value EU	Optional	
ICH	G.k.3.3	Name of Holder / Applicant	60	AN	Free Text	Optional	
ICH	-	<b>Dosage and Relevant Information (repeat as necessary)</b>	-	-	-	-	-
ICH	G.k.4.r.1a	Dose (number)	8	N	Numeric	Conditional-Mandatory	Mandatory if G.k.4.r.1b is populated
ICH	G.k.4.r.1b	Dose (unit)	50	AN	UCUM	Conditional-Mandatory	Mandatory if G.k.4.r.1a is populated. See note 11
ICH	G.k.4.r.2	Number of Units in the Interval	4	N	Numeric	Conditional-Mandatory	Mandatory if G.k.4.r.3 is populated
ICH	G.k.4.r.3	Definition of the Time Interval Unit	50	AN	UCUM	Conditional-Mandatory	Mandatory if G.k.4.r.3 is populated unless the definition of the time interval unit (G.k.4.r.3) is 'cyclical', 'as necessary', or 'total'.
ICH	G.k.4.r.4	Date and Time of Start of Drug	-	Date/Time	CCYY (Minimum)	Optional	Minimum precision required is the year (i.e. 'CCYY'). Should precede G.k.4.r.5. See note 5
ICH	G.k.4.r.5	Date and Time of Last Administration	-	Date/Time	CCYY (Minimum)	Optional	Minimum precision required is the year (i.e. 'CCYY'). Should be greater or equal to G.k.4.r.4. See note 5
ICH	G.k.4.r.6a	Duration of Drug Administration (number)	5	N	Numeric	Conditional-Mandatory	Mandatory if G.k.4.r.6b is populated
ICH	G.k.4.r.6b	Duration of Drug Administration (unit)	50	AN	UCUM	Conditional-Mandatory	Mandatory if G.k.4.r.6a is populated
ICH	G.k.4.r.7	Batch / Lot Number	35	AN	Free Text	Conditional-Mandatory	Mandatory for all suspected or interacting drugs. Field should be completed with a

							value or an appropriate null flag.
ICH	G.k.4.r.8	Dosage Text	2000	AN	Free Text	Optional	
ICH	G.k.4.r.9.1	Pharmaceutical Dose Form (free text)	60	AN	Free Text	Optional	
ICH	G.k.4.r.9.2a	Pharmaceutical Dose Form TermID Version Date/Number	10	AN	Free Text	Conditional-Mandatory	Mandatory if G.k.4.r.9.2b is populated. Numeric values and the decimal point only.
ICH	G.k.4.r.9.2b	Pharmaceutical Dose Form TermID	100	AN	DoseFormID	Conditional-Mandatory	Mandatory if G.k.4.r.9.2a is populated.
ICH	G.k.4.r.10.1	Route of Administration (free text)	60	AN	Free Text	Optional	
ICH	G.k.4.r.10.2a	Route of Administration TermID Version Date / Number	4* E2B(R2) 10* E2B(R3)	AN	N.N* E2B(R2) Free Text E2B(R3)	Conditional-Mandatory	Mandatory if G.k.4.r.10.2b is populated. Numeric values and the decimal point only.
ICH	G.k.4.r.10.2b	Route of Administration TermID	3* E2B(R2) 100* E2B(R3)	N* E2B(R2) AN* E2B(R3)	E2B(R2) - RoA* E2B(R3) - RoAID	Conditional-Mandatory	Mandatory if G.k.4.r.10.2a is populated.
ICH	G.k.4.r.11.1	Parent Route of Administration (free text)	60	AN	Free Text	Optional	
ICH	G.k.4.r.11.2a	Parent Route of Administration TermID Version Date / Number	4* E2B(R2) 10* E2B(R3)	AN	N.N* E2B(R2) Free Text E2B(R3)	Conditional-Mandatory	Mandatory if G.k.4.r.11.2b is populated. Numeric values and the decimal point only.
ICH	G.k.4.r.11.2b	Parent Route of Administration TermID	3* E2B(R2) 100* E2B(R3)	N* E2B(R2) AN* E2B(R3)	E2B(R2) - RoA* E2B(R3) - RoAID	Conditional-Mandatory	Mandatory if G.k.4.r.11.2a is populated.
-	-	-	-	-	-	-	-
ICH	G.k.5a	Cumulative Dose to First Reaction (number)	10	N	Numeric	Conditional-Mandatory	Mandatory if G.k.5b is populated
ICH	G.k.5b	Cumulative Dose to First Reaction (unit)	50	AN	UCUM	Conditional-Mandatory	Mandatory if G.k.5a is populated. See note 11
ICH	G.k.6a	Gestation Period at Time of Exposure (number)	3	N	Numeric	Conditional-Mandatory	Mandatory if G.k.6b is populated
ICH	G.k.6b	Gestation Period at Time of Exposure (unit)	50	AN	UCUM	Conditional-Mandatory	Mandatory if G.k.6a is populated
ICH	-	<b>Indication for Use in Case (repeat as</b>	-	-	-	-	-

		<b>necessary)</b>					
ICH	G.k.7.r.1	Indication as Reported by the Primary Source	250	AN	Free Text	Optional	
ICH	G.k.7.r.2a	MedDRA Version for Indication	4	AN	N.N	Conditional-Mandatory	Mandatory if G.k.7.r.2b is populated. Numeric values and the decimal point only. See note 1
ICH	G.k.7.r.2b	Indication (MedDRA code)	8	N	MedDRA	Conditional-Mandatory	Mandatory if G.k.7.r.2a or G.k.7.r.1 is populated. See note 1
-	-	-	-	-	-	-	-
ICH	G.k.8	Action(s) Taken with Drug	1	N	(0,1,2,3,4,9)	Optional	
ICH_CSV	G.k.8.CSV	Action(s) Taken with Drug code system version	4	N	2.0	Conditional-Mandatory	CSV should be provided with G.k.8
ICH	-	<b>Drug-reaction(s) / Event(s) Matrix (repeat as necessary)</b>	-	-	-	-	-
ICH	G.k.9.i.1	Reaction(s) / Event(s) Assessed	-	-	UUIIDs Recommended	Optional	-
ICH	G.k.9.i.2.r.1	Source of Assessment	60	AN	Free text	Optional	
EU	G.k.9.i.2.r.1.EU.1	EU Source of Assessment	1	N	[1-6]	Conditional-Mandatory	Mandatory if G.k.9.i.2.r.2.EU1 = '1' . Value must be [1-3] if the report is sent to EVCTM or [3-6] if sent to EVHUMAN
EU_CSV	G.k.9.i.2.r.1.EU.1.CSV	EU Source of Assessment code system version	4	N	1.0	Conditional-Mandatory	CSV should be provided with G.k.9.i.2.r.1.EU.1
ICH	G.k.9.i.2.r.2	Method of Assessment	60	AN	Free text	Optional	
EU	G.k.9.i.2.r.2.EU.1	EU Method of Assessment	1	N	(1)	Conditional-Mandatory	For submissions to EVCTM Medicinal product classified as suspect or interacting (G.k.1 = 1,3) should have at least one EU method of assessment for each event/reaction reported in the ICSR. This is optional for ICSRs is sent to EVHUMAN.

EU_CSV	G.k.9.i.2.r.2.E U.1.CSV	EU Method of Assessment code system version	4	N	1.0	Conditional-Mandatory	CSV should be provided with G.k.9.i.2.r.2.EU.1
ICH	G.k.9.i.2.r.3	Result of Assessment	60	AN	Free text	Optional	
EU	G.k.9.i.2.r.3.E U.1	EU Result of Assessment	1	N	(1,2)	Conditional-Mandatory	Mandatory if G.k.9.i.2.r.2.EU1 = '1'
EU_CSV	G.k.9.i.2.r.3.E U.1.CSV	EU Result of Assessment code system version	4	N	1.0	Conditional-Mandatory	CSV should be provided with G.k.9.i.2.r.3.EU.1
ICH	G.k.9.i.3.1a	Time Interval between Beginning of Drug Administration and Start of Reaction / Event (number)	5	N	Numeric	Conditional-Mandatory	Mandatory if G.k.9.i.3.1b is populated
ICH	G.k.9.i.3.1b	Time Interval between Beginning of Drug Administration and Start of Reaction / Event (unit)	50	AN	UCUM	Conditional-Mandatory	Mandatory if G.k.9.i.3.1a is populated
ICH	G.k.9.i.3.2a	Time Interval between Last Dose of Drug and Start of Reaction / Event (number)	5	N	Numeric	Conditional-Mandatory	Mandatory if G.k.9.i.3.2b is populated
ICH	G.k.9.i.3.2b	Time Interval between Last Dose of Drug and Start of Reaction / Event (unit)	50	AN	UCUM	Conditional-Mandatory	Mandatory if G.k.9.i.3.2a is populated
ICH	G.k.9.i.4	Did Reaction Recur on Re- administration?	1	N	[1-4]	Optional	
ICH_CSV	G.k.9.i.4.CSV	Did Reaction Recur on Re- administration? Code system version	4	N	2.0	Conditional-Mandatory	CSV should be provided with G.k.9.i.4
-	-	-	-	-	-	-	-
ICH	G.k.10.r	Additional Information on Drug (coded) (repeat as necessary)	2	N	[1-11]	Optional	
ICH_CSV	G.k.10.r.CSV	Additional Information on Drug (coded) (repeat as necessary) code system version	4	N	2.0	Conditional-Mandatory	CSV should be provided with G.k.10.r
ICH	G.k.11	Additional Information on Drug (free text)	2000	AN	Free Text	Optional	
ICH	-	<b>Narrative Case Summary and Further Information</b>	-	-	-	-	-

ICH	H.1	Case Narrative Including Clinical Course, Therapeutic Measures, Outcome and Additional Relevant Information	100000	AN	Free Text	Optional	
ICH	H.2	Reporter's Comments	20000	AN	Free Text	Optional	
ICH	-	<b>Sender's Diagnosis (repeat as necessary)</b>	-	-	-	-	-
ICH	H.3.r.1a	MedDRA Version for Sender's Diagnosis / Syndrome and / or Reclassification of Reaction / Event	4	AN	N.N	Conditional-Mandatory	Mandatory if H.3.r.1b is populated. Numeric values and the decimal point only. See note 1
ICH	H.3.r.1b	Sender's Diagnosis / Syndrome and / or Reclassification of Reaction / Event (MedDRA code)	8	N	MedDRA	Conditional-Mandatory	Mandatory if H.3.r.1a is populated. See note 1
-	-	-	-	-	-	-	-
ICH	H.4	Sender's Comments	20000	AN	Free Text	Optional	
ICH	-	<b>Case Summary and Reporter's Comments in Native Language (repeat as necessary)</b>	-	-	-	-	-
ICH	H.5.r.1a	Case Summary and Reporter's Comments Text	100000	AN	Free Text	Optional	
ICH	H.5.r.1b	Case Summary and Reporter's Comments Language	3	A	ISO 639-2/RA, alpha-3	Conditional-Mandatory	Mandatory if H.5.r.1a is populated.
-	-	-	-	-	-	-	-

**Table 32- Post-Authorisation Specific Business Rules**

Field Identification			Business rules				
Field ICH or EU	DATA ELEMENT	FIELD NAME	MAX LENGTH	DATA TYPE	VALUES	CONFORMANCE	NOTES
ICH	C.5.4	Study Type Where Reaction(s) / Event(s) Were Observed	1	N	[1-3]	Conditional-Mandatory	Only values [2-3] are accepted by EVHUMAN See note 2
EU	G.k.9.i.2.r.1. EU.1	EU Source of Assessment	1	N	[1-5]	Conditional-Mandatory	Mandatory if G.k.9.i.2.r.2.EU.1 = '1' . Only values [3-6] are valid for EVHUMAN
EU	G.k.9.i.2.r.2. EU.1	EU Method of Assessment	1	N	(1)	Conditional-Mandatory	This is optional for ICSRs sent to EVHUMAN.
EU	G.k.9.i.2.r.3. EU.1	EU Result of Assessment	1	N	(1,2)	Conditional-Mandatory	Mandatory if G.k.9.i.2.r.2.EU1 = '1'

**Table 33 - Clinical Trials Specific Business rules**

Field Identification			Business rules				
Field ICH or EU	DATA ELEMENT	FIELD NAME	MAX LENGTH	DATA TYPE	VALUES	CONFORMANCE	NOTES
ICH	C.1.3	Type of Report	1	N	[1-4]	Mandatory	For submissions to EVCTM value must = 2. See note 2
ICH	C.5.1.r.1	Study Registration Number	50	AN	Free Text or EudraCT number	Conditional-Mandatory	Applies to transmissions to EVCTM: Must be a valid EudraCT number if C.5.1.r.2 = "EU", Null flag not accepted. See note 4
ICH	C.5.1.r.2	Study Registration Country	2	A	ISO 3166-1 alpha-2, including value EU	Conditional-Mandatory	Applies to transmissions to EVCTM: Mandatory when the case originates in the EU, at

							least one iteration must have the value "EU". See note 4
ICH	C.5.2	Study Name	2000	AN	Free Text	Conditional-Mandatory	Applies to transmissions to EVCTM: This field is Mandatory (i.e. must contain text, Nullflavor flag not accepted). See note 4
ICH	C.5.4	Study Type Where Reaction(s) / Event(s) Were Observed	1	N	[1-3]	Conditional-Mandatory	Mandatory if C.1.3 = 2. Value must be 1 for any transmission to EVCTM See note 2 and 4
EU	G.k.9.i.2.r.1. EU.1	EU Source of Assessment	1	N	[1-5]	Conditional-Mandatory	Mandatory if G.k.9.i.2.r.2.EU.1 = '1' . Value must be [1-3] if the report is sent to EVCTM
EU	G.k.9.i.2.r.2. EU.1	EU Method of Assessment	1	N	(1)	Conditional-Mandatory	For submissions to EVCTM Medicinal product classified as suspect or interacting (G.k.1 = 1,3) should have at least one EU method of assessment for each event/reaction reported in the ICSR.
EU	G.k.9.i.2.r.3. EU.1	EU Result of Assessment	1	N	(1,2)	Conditional-Mandatory	Mandatory if G.k.9.i.2.r.2.EU1 = '1'

### I.C.4.1 Business Rule Notes

The notes referenced in business rules Table 31 in section above are detailed in Table 34 below.

**Table 34 – Notes on the business rules**

#	Note	Description
1.	<b>MedDRA Version</b>	<p>The supported MedDRA versions are related to the EV environment (EV compliance testing environment or production environment) that is the recipient of the Safety Message transmission.</p> <p>It also relates to the current MedDRA version officially published by the MedDRA Maintenance Support Service Organisation (MSSO). The EV compliance testing environment supports MedDRA version 4.0 and higher. The EV production environment supports the previous and the current MedDRA version.</p> <p>The validation process of the ICSRs accepts only current lower level term (LLT) numeric codes of the supported MedDRA versions. All stakeholders should follow the recommendations of the MedDRA MSSO regarding the switch to a new MedDRA version. The latest supported MedDRA versions in line with the official semi-annual releases as published by the MSSO. The use of non-valid or non-current numeric MedDRA LLT codes generates an error message in the validation process.</p>
2.	<b>Type of Report and Study Type</b>	<p>The data element <i>Type of Report</i> (ICH E2B(R3) C.1.3) is mandatory for all transmissions and the data element <i>Study Type</i> (ICH E2B(R3) C.5.4) must be specified when the report type is '2' (report from study).</p> <p>a) For ICSRs sent to EVPM:</p> <ul style="list-style-type: none"> <li>• When the value of the data element <i>Type of Report</i> (ICH E2B(R3) C.1.3) is '2' (report from study), the data element <i>Study Type</i> (ICH E2B(R3) C.5.4) should not be NULL and the accepted values are '2' (individual patient use) or '3' (other studies).</li> <li>• When the value of the data element <i>Study Type</i> (ICH E2B(R3) C.5.4) is '2' (individual patient use) or '3' (other studies), the accepted value for the data element <i>Type of Report</i> (ICH E2B(R3) C.1.3) is '2' (report from study).</li> </ul> <p>b) For SUSARs sent to EVCTM:</p> <ul style="list-style-type: none"> <li>• The accepted value for the data element <i>Type of Report</i> (ICH E2B(R3) C.1.3) is '2' (report from study). The data element <i>Study Type</i> (ICH E2B(R3) C.5.4) should not be NULL and the accepted value is '1' (clinical trial).</li> </ul> <p>When follow-up information impacts on the type of report or the type of study, the report should always be reclassified with the most specific information and resubmitted to the appropriate system (EVPM or EVCTM). Nullifications should not be sent in such instances.</p>
3.	<b>Patient / parent's age, height or</b>	<p>If the patient/parent's age, height or weight value is above the allowed upper limit, the relevant ICH E2B(R3) data element should remain empty and the information should be reported in the data element <i>Case Narrative</i> (ICH E2B(R3) H.1). Reported values above the upper limits generate an error</p>



#	Note	Description
	<b>weight</b>	message.
4.	<b>Study Registration Number</b>	<p>For transmissions to EVCTM, the data element <i>Study Registration Number</i> (ICH E2B(R3) C.5.1.r.1) should contain a valid EudraCT number when the field <i>Study Registration Country</i> (ICH E2B(R3) C.5.1.r.2) contains the value 'EU'.</p> <p>a) For SUSARs originating within the EEA, where Reporter's Country Code (ICH E2B(R3) C.2.r.3) is an EEA country and the field <i>Primary Source for Regulatory Purposes</i> (ICH E2B(R3) C.2.r.5) has the value '1' :</p> <ul style="list-style-type: none"> <li>At least one iteration of <i>Study Registration</i> (ICH E2B(R3) C.5.1.r) must contain the value 'EU' in the field (ICH E2B(R3) C.5.1.r.2) and a valid EudraCT should be provided in the field (ICH E2B(R3) C.5.1.r.1)</li> </ul> <p>b) For SUSARs originating outside the EEA, where Reporter's Country Code (ICH E2B(R3) C.2.r.3) is not an EEA country and the field <i>Primary Source for Regulatory Purposes</i> (ICH E2B(R3) C.2.r.5) has the value '1' :</p> <ul style="list-style-type: none"> <li>If the clinical trial is conducted exclusively outside the EEA or is not contained in an agreed Paediatric Investigation Plan a valid EudraCT does not need to be provided</li> <li>If the clinical trial is also being conducted in the EEA a valid EudraCT number should be entered in the field <i>Study Registration Number</i> (ICH E2B(R3) C.5.1.r.1) and the <i>Study Registration Country</i> (ICH E2B(R3) C.5.1.r.2) should contain the value 'EU'.</li> </ul> <p>A valid EudraCT Number should match with an authorised number in the EudraCT database and should have the format YYYY-NNNNNN-CC, where</p> <ul style="list-style-type: none"> <li>YYYY is the year in which the number has been issued,</li> <li>NNNNNN is a six digit sequential number,</li> <li>CC is a check digit.</li> </ul> <p>The following generic EudraCT Number is provided for all interventional clinical trials including a centre in a Member State and started before 01 May 2004 (or before the clinical trial Directive 2001/20/EC has been implemented in a Member State): <b>EVCT-000000-16</b>. It should be used in the data element <i>Study Registration Number</i> (ICH E2B(R3) C.5.1.r.1) and the <i>Study Registration Country</i> (ICH E2B(R3) C.5.1.r.2) should contain the value 'EU' <u>for these interventional clinical trials only</u>.</p> <p>When the sponsor does have clinical trials ongoing in the EEA with the same IMP, the reports of SUSARs from third country trials not authorised in the EEA should be submitted to EVCTM in accordance with the Directive 2001/20/EC. The 7 days reporting requirements for fatal and life threatening SUSARs apply. The recommendations detailed in point b) above should be followed.</p>
5.	<b>Dates</b>	No date/time value should exceed the current UK GMT time plus 12 hours. Failure of the validation of the date format generates an error.

#	Note	Description																																										
		All dates should be inferior or equal to the EudraVigilance Gateway date plus 12 hours. Failure of this validation generates an error.																																										
6.	<b>Batch Receiver Identifier and Message Receiver Identifier</b>	<p>When submitting a Safety Message to EudraVigilance, the value accepted in the data element <i>Batch Receiver Identifier</i> (ICH E2B(R3) N.1.4) and Message Receiver Identifier (ICH E2B(R3) N.2.r.3) should be one of the following, depending to which module the message is addressed:</p> <ul style="list-style-type: none"> <li>• 'EVTEST' (Test environment – EVPM)</li> <li>• 'EVHUMAN' (Production environment – EVPM)</li> <li>• 'EVCTMTEST' (Test environment – EVCTM)</li> <li>• 'EVCTMPROD' (Production environment – EVCTM).</li> </ul>																																										
7.	<b>Report Nullification Amendment</b>	Details on the nullification process and specific rules are provided in section I.C.6.1.1																																										
8.	<b>Spanish Reporter's State or Province Codes</b>	<p>Mandatory if the data element "Reporter's Country Code" (C.2.r.3) is "ES" (Spain) and "Primary Source for Regulatory Purposes" C.2.r.5 = 1.</p> <p>Data element reporter state should be populated in accordance with this list:</p> <table border="1"> <thead> <tr> <th>Code</th> <th>Description</th> </tr> </thead> <tbody> <tr><td>00</td><td>UNKNOWN</td></tr> <tr><td>01</td><td>ANDALUCIA</td></tr> <tr><td>02</td><td>ARAGON</td></tr> <tr><td>03</td><td>ASTURIAS</td></tr> <tr><td>04</td><td>ISLAS BALEARES</td></tr> <tr><td>05</td><td>CANARIAS</td></tr> <tr><td>06</td><td>CANTABRIA</td></tr> <tr><td>07</td><td>CASTILLA Y LEON</td></tr> <tr><td>08</td><td>CASTILLA-LA MANCHA</td></tr> <tr><td>09</td><td>CATALUNA</td></tr> <tr><td>10</td><td>COMUNIDAD VALENCIA</td></tr> <tr><td>11</td><td>EXTREMADURA</td></tr> <tr><td>12</td><td>GALICIA</td></tr> <tr><td>13</td><td>COMUNIDAD DE MADRID</td></tr> <tr><td>14</td><td>MURCIA</td></tr> <tr><td>15</td><td>NAVARRA</td></tr> <tr><td>16</td><td>PAIS VASCO</td></tr> <tr><td>17</td><td>LA RIOJA</td></tr> <tr><td>18</td><td>CEUTA</td></tr> <tr><td>19</td><td>MELILLA</td></tr> </tbody> </table> <p>The information provided in the data element reporter state (ICH E2B (R3) C.2.r.2.5) should correspond to one of the 20 numeric codes identifying the Autonomous EU where the city/town of the primary source is located.</p>	Code	Description	00	UNKNOWN	01	ANDALUCIA	02	ARAGON	03	ASTURIAS	04	ISLAS BALEARES	05	CANARIAS	06	CANTABRIA	07	CASTILLA Y LEON	08	CASTILLA-LA MANCHA	09	CATALUNA	10	COMUNIDAD VALENCIA	11	EXTREMADURA	12	GALICIA	13	COMUNIDAD DE MADRID	14	MURCIA	15	NAVARRA	16	PAIS VASCO	17	LA RIOJA	18	CEUTA	19	MELILLA
Code	Description																																											
00	UNKNOWN																																											
01	ANDALUCIA																																											
02	ARAGON																																											
03	ASTURIAS																																											
04	ISLAS BALEARES																																											
05	CANARIAS																																											
06	CANTABRIA																																											
07	CASTILLA Y LEON																																											
08	CASTILLA-LA MANCHA																																											
09	CATALUNA																																											
10	COMUNIDAD VALENCIA																																											
11	EXTREMADURA																																											
12	GALICIA																																											
13	COMUNIDAD DE MADRID																																											
14	MURCIA																																											
15	NAVARRA																																											
16	PAIS VASCO																																											
17	LA RIOJA																																											
18	CEUTA																																											
19	MELILLA																																											
9	<b>Patient identifiers</b>	At least one patient identifier is required to indicate that a patient exists this is met through the completion of at least one of the following fields D.1, D.1.1.1, D.1.1.2, D.1.1.3, D.1.1.4, D.2.1, D.2.2A, D.2.2.1a, D.2.3 or D.5. The use of																																										

#	Note	Description
		<p>"UNK", "ASKU" or "NASK" nullflavors in any of the patient identifier fields does not indicate that a patient exists.</p> <p>If due to data privacy the name or initials of the patient is known but cannot be provided the nullflavor "MSK" can be used and will pass the validation rules.</p> <p>If nullflavor "MSK" is used in the date of birth field then either the patient age or patient age group should be completed, if not an error message will be generated</p>
10	<b>Safety reports within the same batch</b>	<p>The worldwide case ID and safety report IDs cannot be repeated for separate ICSRs within the same safety message.</p> <p>If more than one version of an ICSR needs to be sent within the same timeframe this should be done by creating separate safety messages.</p>
11	<b>UCUM Units</b>	<p>The quoted UCUM unit needs to match a valid current value as published in the current full EU list<sup>9</sup>. The list will also indicate if the unit is suitable for use as a Lab test unit, Dose Unit and/or a Strength unit.</p> <p>Units marked as unsuitable for a specific field will generate warning message in order to indicate a possible data quality issue.</p>
12	<b>Case identifier format</b>	<p>For the fields safety report ID C.1.1, worldwide case ID C.1.8.1 and C.1.10.r linked report number the following regular expression is used to check that the correct format has been applied in addition to requiring that the first two letters match a 3166 country code:</p> <p>[A-Z]{2}[-]{1}[^]{1}.+[-]{1}.\$</p> <p>The following example is in the valid format</p> <p>ES-MAHID-20173201701</p> <p>"Country code" – "organisation ID or name" – "local system number"</p>
13	<b>File attachments</b>	<p>The file attachments of an ICSR above 15Mb will not be processed, however the ICSR will be loaded and a warning message will be included in the acknowledgement, if there are no other validation issues the acknowledgement code "AA" will be returned.</p>
14	<b>Tests &amp; procedures relevant to the investigation</b>	<p>The results of a test can be reported in one of three distinct ways:</p> <ol style="list-style-type: none"> <li>1. F.r.3.1 Test Result (code)</li> <li>2. The combination of F.r.3.2 Test Result &amp; F.r.3.3 Test Result (unit)</li> <li>3. F.r.3.4 Result Unstructured Data</li> </ol> <p>If a single Test section (F.r) contains more than one of the above distinct test results the ICSR will be rejected with an error.</p>

## I.C.5 The ICH Acknowledgment Message

The acknowledgment message is an integral part of the exchange of ICSR messages, further details on this exchange can be seen in section I.C.2.1. The sections below explain how acknowledgment

<sup>9</sup>[http://www.ema.europa.eu/ema/index.jsp?curl=pages/regulation/q\\_and\\_a/q\\_and\\_a\\_detail\\_000165.jsp&mid=WC0b01ac0580a69263](http://www.ema.europa.eu/ema/index.jsp?curl=pages/regulation/q_and_a/q_and_a_detail_000165.jsp&mid=WC0b01ac0580a69263)

messages are generated by the EudraVigilance system and in particular how error messages are generated when ICSRs do not fulfil the business rule requirements.

### ***I.C.5.1 Acknowledgment Message Elements***

The data element *Transmission Acknowledgement Code* (ICH E2B(R3) ACK.A.4) is a 2A field that informs the sender of the ICH ICSR message to either re-send the complete transmission, review the Acknowledgments of individual ICSRs within the message or no further action is required.

The possible Transmission Acknowledgment Code values are:

**AA** – Application Acknowledgement Accept (message successfully processed, no further action)

**AE** – Application Acknowledgment Error (error detected, error response has additional detail, some ICSR message(s) need further action)

**AR** – Application Acknowledgment Reject (parsing error, no data extracted, re-send the entire transaction)

### ***I.C.5.2 Parsing error message***

The *Batch Validation Error* data element (ICH E2B(R3) ACK.A.5) is a text field (250 characters) and it is included in the Acknowledgment Message only if the data *Transmission Acknowledgement Code* (ICH E2B(R3) ACK.A.4) has the value is "AR" i.e. XML parsing error, no data extracted. This field describes the error generated by the EudraVigilance XML parser or from the cardinality checks described in section I.C.5.2.1 .

#### ***I.C.5.2.1 ICSR Message Cardinality checks***

In accordance with ICH specifications (logical model) certain sections should appear only once e.g. Patient section should appear only once, the ISO ICSR schema is flexible and does not prevent some sections from being repeated. Therefore the EV message processing system performs cardinality checks to ensure that non-repeatable sections are not repeated within a message. If such inconsistencies are detected the ICSR message is rejected with an "AR" acknowledgment.

### ***I.C.5.3 ICSR Message Acknowledgment Elements***

The data element *Acknowledgement Code* for an ICSR Message (ICH E2B(R3) ACK.B.r.6) is a 2A field that informs the sender of the status of each ICH ICSR within a message and if the ICSR needs to be corrected and resent.

The possible Acknowledgement Codes values for an ICSR are:

**CA** – Commit Accept (the ICSR message successfully loaded, no further action required)

**CR** – Commit Reject (the ICSR message contains fatal error that prevents the ICSR from being loaded, the ICSR needs to be corrected and resent)

### ***I.C.5.4 Error/Warning message comments***

The data element *Error / Warning Message or Comment* (ICH E2B(R3) ACK.B.r.7) appears in the section ACK.B ICH *ICSR message acknowledgement*, which is provided for each ICSR included in the Safety Message. This field is 250AN in the ICH E2B(R3) implementation guide however to allow for

additional information to be provided senders of ICSRs on the issues identified in transmissions this field is extended to 2000AN in the EU.

- If the value for the data element *Acknowledgement Code for an ICSR Message* (ICH E2B(R3) ACK.B.r.6) is "CR" (Commit Reject) there are one or more errors in the ICSR and not all the data have been loaded successfully. In the data element *Error / Warning Message or Comment* (ICH E2B(R3) ACK.B.r.7) the errors and warnings encountered during the validation processes of the ICSR are described. After this the system adds the classification outcome for the analysed ICSR(s)
- If the value for the data element value for the data element *Acknowledgement Code for a ICSR Message* (ICH E2B(R3) ACK.B.r.6) is "CA" (Commit Accept) the corresponding ICSR is loaded successfully and in the data element *Error / Warning Message or Comment* (ICH E2B(R3) ACK.B.r.7) the classification result is presented. In case the validation processes of the ICSR have detected warnings, their textual description is included in the data element *Error / Warning Message or Comment* (ICH E2B(R3) ACK.B.r.7).

### I.C.5.4.1 Error / Warning Message or Comment (ACK.B.r.7)

The XML snippet in Figure 21 below shows an example of an Error message comment for a valid report without errors.

**Figure 21 - XML Snippet: Error message comment**

```
<acknowledgementDetail>
  <text>safety report loaded; Validated against 1.1 business rules;
Comments: Parsing process: Parsing process: Correct Report; Classification: new: EU-EC -
123202 = Case Report - old: EU-EC -123174 = Replaced Report </text>
</acknowledgementDetail>
```

Table 35 below shows the structure of the *Error / Warning Message or Comment* (ICH E2B(R3) ACK.B.r.7) as produced by the EudraVigilance system. It also includes an example of the text that would be produced for a valid submission as shown in the XML snippet above.

**Table 35 – Structure of the error message comment**

Section	Error message comment section	Example
1	<b>Loading &amp; Validation Information:</b> 1. Safety report loaded 2. Safety report not loaded  Validated against <current business rules>	<i>Safety report loaded; Validated against 1.1 business rules;</i>
2	<b>Error and Warning List (May not be present)</b>	<i>Comments:</i>
3	<b>Error/Warning Element(s)</b>	
4	<b>Parsing Information:</b> Correct Report	Parsing process: Correct Report;

Section	Error message comment section	Example
	Report with Warnings Report with Errors	
5	<b>Classification information:</b>  See section I.C.6 ICSR Classification for details	Classification:
6	<b>Current Report Classification:</b>  Displays the EV report ID and the classification outcome	new: EU-EC -123202 = Case Report -
7	<b>Old Report Classification:</b>  Displays the EV report ID which was previously stored in the system, and the reclassification status of the previously stored report.	old: EU-EC -123174 = Replaced Report

The XML snippet below in Figure 22 shows an example of an Error message comment for a non-valid report that has errors.

**Figure 22 - XML Snippet: Error message comment (Error report)**

```

<acknowledgementDetail>
  <text>safety report not loaded; Validated against 1.1 business rules;
Comments: 1- [101] :In section Drug(s) on field Medicinal Product Identifier (MPID) (ICH E2B(R3)
G.k.2.1.1b) Value: '837336' Reported error BUSINESSRULES – LOOKUP CheckMPID '837336'
must be a valid MPID code; Parsing process:
Report with Errors </text>
</acknowledgementDetail>

```

Table 36 below shows how the system structures section 3 of Table 35 above (Error/Warning Element(s)). It also includes a breakdown of the example text shown in the XML snippet above in Figure 22.

**Table 36– Section 3 of the error message comment**

Section	Error/Warning Element(s)	Example
a	A sequence number	1-
b	The section in which there is the wrong element	In section DRUG(s)
c	The element name to which the warning/error is referring to	on field Medicinal Product Identifier (MPID) (ICH E2B(R3) G.k.2.1.1b)
d	The element value to which the warning/error is referring to	Value: 837336
e	Describes if the comment reported is referring to an error or a warning	Reported error

Section	Error/Warning Element(s)	Example
f	The class of error/warning that it is reported	BUSINESSRULES – LOOKUP
g	A more detailed textual description of the warning/error	CheckMPID 837336 must be a valid MPID code;

### I.C.5.4.1 Field Level error description list

Table 37 below provides details on the field level error descriptions that can be found in section “g” of the error/warning element(s) that can be seen in Table 36 above.

**Table 37 – Field level errors descriptions and format**

Field Level error	Error description	Comment format
Enumeration List Error	If the element value is not part of a standard value list.	<i>Enumeration constraint failed. The element &lt;element name - E2B(R3) Ref.&gt; has an invalid value.</i>
Max Inclusive Error	If the data element’s value exceeding the maximum allowed.	<i>MaxInclusive constraint failed. The element &lt;element name - E2B(R3) Ref.&gt; exceeds the maximum allowed.</i>
Max Length Error	If the content of the data element exceeding its maximum allowed length.	<i>MaxLength constraint failed. The element &lt;element name - E2B(R3) Ref.&gt; exceeds the maximum allowed length.</i>
Min Inclusive Error	If the data element’s value is smaller than the minimum allowed.	<i>MinInclusive constraint failed. The element &lt;element name - E2B(R3) Ref.&gt; is smaller than the minimum allowed.</i>
Total Digit Error	If the content of the data element exceeding the maximum number of admissible digits	<i>totalDigits constraint failed. The element &lt;element name - E2B(R3) Ref.&gt; exceeds the maximum allowed number of characters.</i>
Fraction Digit Error	If the element data representing a decimal, exceeds the maximum number of digits in the fractional part	<i>fractionDigits constraint failed. The element &lt;element name - E2B(R3) Ref.&gt; representing a decimal, exceeds the maximum number of digits in the fractional part</i>
Date Length Error	If the element representing a date, has an unexpected number of digits:	<i>Data Length not correct. The element &lt;element name - E2B(R3) Ref.&gt; has an unexpected number of digits (Required: CCYYMMDD Value: 200212);</i>
Lookup MedDRA LLT Error	If the element value does not match a valid MedDRA LLT code.	<i>&lt;value&gt; must be a valid MedDRA LLT code.</i>
Lookup MPID Error	If the element value, does not match with a valid MPID	<i>&lt;value&gt; must be a valid MPID code</i>

Field Level error	Error description	Comment format
	code.	
Lookup PhPID Error	If the element value, does not match with a valid PhPID code.	<i>&lt;value&gt; must be a valid PhPID</i>
Lookup Substance ID Error	If the element value, does not match with a valid Substance ID code.	<i>&lt;value&gt; must be a valid Substance ID</i>
Lookup Device ID Error	If the element value, does not match with a valid Device ID code.	<i>&lt;value&gt; must be a valid Device ID</i>
Lookup Dosage form Error	If the element value, does not match with a valid Dosage form code.	<i>&lt;value&gt; must be a valid Dosage form</i>
Lookup Country Code	If the element value, does not match with a valid Country code.	<i>&lt;value&gt; must be a valid Country code</i>
Lookup Language Error	If the element value, does not match with a valid Language code.	<i>&lt;value&gt; must be a valid Language code</i>
Lookup MedDRA version Error	If the MedDRA version is not supported the following error is generated.	<i>The stated MedDRA version is not supported</i>
Future date	If the element, that represents a date, indicates a future date.	<i>NON Valid Date: future date (05/04/50).</i>
Start end date error	If the element, that represents an end date, is previous to the start date.	<i>NOT Valid enddate. Enddate (20/01/01) must be greater than corresponding Startdate (22/01/01).</i>
Pattern Formation Error	The element value must be specified using a specific pattern e.g. XX-ABCDEFH-12345678 and the given value does not comply with this pattern.	<i>The element referred must conform to the agreed format.</i>
Pattern Constituent Value Error	In an element that must be given in a pattern, one or more of the parts of the pattern is validated.  This error indicates a failure in this validation e.g. country code element of the	<i>The element must have valid values in each checked section of the data pattern.</i>



Field Level error	Error description	Comment format
	given 'Worldwide unique case identification number'.	
Unsupported use of Nullflavor flag	A null flavour flag or type of null flavour flag has been used in field where it is not permitted	<i>The element cannot contain this nullflavor flag.</i>
Nullflavor flag missing	A required data element has been left blank, a nullflavor flag must be selected if no information is available	<i>The element cannot be blank a nullflavor flag must be used if no information is available.</i>
Attachment max size	A file attachment is above the maximum permitted file size	<i>The file attachment is above the maximum file size please reduce the file size and resubmit the file.</i>
Unsupported file type attachment	The file type of the attachment is not supported	<i>The file type of the attachment is not supported</i>
Attachment virus scan	A virus scan of a file attachment is reporting the presence of an infected file	<i>A virus scan of the file attachment is reporting an infected file</i>
Worldwide Unique Case Identification  The value of Sender's (case) Safety Report Unique Identifier - C.1.1 must be unique per batch message.	The value of Worldwide Unique Case Identification - C.1.8.1 must be unique per batch message.	<i>The value of Worldwide Unique Case Identification - C.1.8.1 must be unique per batch message.</i>
Sender's (case) Safety Report Unique Identifier	The value of Sender's (case) Safety Report Unique Identifier - C.1.1 must be unique per batch message.	<i>The value of Sender's (case) Safety Report Unique Identifier - C.1.1 must be unique per batch message.</i>

#### I.C.5.4.2 Field Pair Error description list

Table 38 below provides details on the field pair error descriptions that can be found in section "g" of the error/warning element(s) that can be seen in Table 36 above.

**Table 38 - Field pair errors descriptions and format**

Field Level error	Error description	Comment format
Element Null Error	If the element must be null as the value of another corresponding element requires this.	<i>Since the element &lt;element name - E2B(R3) Ref.&gt; has the value &lt;value&gt;, the element &lt;element name - E2B(R3) Ref.&gt; cannot contain a value.</i>

Field Level error	Error description	Comment format
Element Value required	The element value must be specified as the value of another element requires it. This error is signalled when a MedDRA term has been specified but the corresponding MedDRA version field has been left empty.	Since the element <element name - E2B(R3) Ref.> has a value, the element <element name - E2B(R3) Ref.> must contain a value.

### I.C.5.4.3 Section Level Error description list

Table 39 below provides details on the section level errors descriptions that can be found in section “g” of the error/warning element(s) that can be seen in Table 36 above. These errors occur where multiple instances of the same section are used within the same report or where errors do not pertain to a single field.

**Table 39 - Section level errors descriptions and format**

Field Level error	Error description	Comment format
At Least One Error	If one element between n-elements must be present, but no element is specified.	At least one field must be populated in this section
At Most One Error	If at most one element can be present, but there is more than one element specified.	<i>Only one of these elements can contain a value: Primary source country for regulatory purpose</i>
At Least One Section Field Value Error	The element value must be present with a specific value given in at least one of the repeated sections.  This error is generated when one section must have a particular drug characterisation.	The value <value> must be present in the element <element name - E2B(R3) Ref.> in one of the repeated sections.

### I.C.6 ICSR Classification

ICSR classification is a process in which EV manages the versioning of the incoming ICSRs. The classification rules are designed to maintain a concept where the most recent information on a specific case is available for pharmacovigilance analysis via an ICSR classified as a "Case Report". In addition, the entire history of the ICSRs related to a specific case is also maintained in the form of Replaced Reports.

Administrative process allow for the maintenance of ICSRs which have been nullified by the original sender or another sender, the reasons for the nullification of a case must be provided.

A report may be classified as:

- **Case report** - is a report describing a case for the first time (Initial report) or at a later time (Follow-up report or amended report). It is the classification assigned to the most recent version of a case received by EV.
- **Replaced report** - is a case report superseded by a case report with a more recent receipt date based on the follow-up information or a case report nullified by a nullification report.
- **Error report** - is a report containing syntactic or semantic mistakes.
- **Nullified report** - is a report with the data element *Report Nullification / Amendment* (ICH E2B(R3) C.1.11.1) has the value "1" – "Nullification"
- **Nullification request** – is a nullification report that is associated with a non EEA case that has previously been submitted by another organisation
- **EEA Nullification request** – is a nullification report that is associated with an EEA case that has previously been submitted by another organisation

### ***I.C.6.1 Classification algorithm***

This chapter presents the classification algorithm based on the data element *Report Nullification / Amendment* (ICH E2B(R3) C.1.11.1), as well as the case number (ICH E2B(R3) C.1.8.1 Worldwide Unique Case Identification Number) and the data element *Date of Most Recent Information for This Report* (ICH E2B(R3) C.1.5). Figure 23, below shows the classification algorithm for new and follow-up reports, which are identified by the *Report nullification amendment* field (ICH E2B(R3) C.1.11.1) being different to 1.

**Figure 23 - New and Follow Up Reports**

```
If the nullification field of loading report <> 1
If case number of loading report <> case number of pre-existing report
    --> Type of loading report =case report

If case number of loading report = case number of pre-existing report and headquarter
organisation ID of loading report = headquarter organisation ID of that pre-existing report, the
following applies:
    - if receipt date of loading report >= receipt date of pre-existing report
        --> Type of loading report =case report
        --> Type of pre-existing report =replaced report
    - if receipt date of loading report < receipt date of pre-existing report
        --> Type of loading report =replaced report
```

The classification outcome is reported in the data element *Error / Warning Message or Comment* (ICH E2B(R3) ACK.B.r.7) of the Report Acknowledgment section please see section I.C.5.4 for further details.

### I.C.6.1.1 Nullification Reports

When an organisation submits a nullification report, EudraVigilance will automatically mark an ICSR as nullified if the pre-existing case has been submitted by the same organisation or one of its affiliates. These nullification reports will have the report classification "Nullified report". The nullification report will also be forward to NCAs in line with the rerouting rules in section I.C.2.2

If a nullification no pre-existing case from the same organisation or one of its affiliates is found in EudraVigilance the following rules apply:

- If the nullification concerns an EEA case, the nullification report will be stored and the nullification retransmitted to the concerned NCA. The concerned NCA should then review the nullification, if the nullification is for a valid reason the NCA should submit a nullification for the case they have previously submitted to EudraVigilance. The nullification reports from the sending organisation will have the report classification "EEA Nullification request"
- If the case is from outside the EEA the case ID must match a case ID that already exists in the EudraVigilance database. If no matching case ID exists the nullification report will be rejected. If a matching case ID is found the nullification will be accepted and stored with the report classification "Nullification request". The EMA will then review the nullification request and if the nullification is for valid reason will mark the associated ICSRs as nullified through changing the report classification of the appropriate ICSRs to "Nullified report".

### I.C.6.1.2 Master Cases

Duplicate cases are generally managed through a process of merging two-or-more cases into one Master Case. This process can consist of one of the following approaches:

- The Master Case can either be based on one of the existing cases, with information from the other subordinate duplicate case added unless the same, or more-precise, information is already present in the Master Case, or
- The Master Case can be created as a new case combining the information from the subordinate duplicate cases.

The approach taken by the Agency in managing duplicates in EudraVigilance is the latter of these two. Regardless of the approach chosen, the Master Case should always contain all the case reference numbers from all subordinate duplicate cases, such that they can be easily traced. The Master Case should reflect the most accurate and up-to-date information available to the organisation. Guidance on duplicate management is available in the CHMP Guideline on Detection and Management of Duplicate Individual Cases and Individual Case Safety Reports (ICSRs), Doc. Ref. EMA/13432/2009. See section I.C.6.1.3 case clustering for details of how duplicate and master cases are classified in EudraVigilance.

### I.C.6.1.3 Case clustering

Case clustering is based on the values from the ICSR classification, and combines these with the duplicate management outputs to manage the grouping of multiple versions of multiple cases and describes the validity for pharmacovigilance purposes.

A report within a case cluster may be classified as:

- **Master** – the most recent valid version of a case. This is the version of a case which is valid for pharmacovigilance purposes. This could be an initial report (if only one valid version of a report for

this case has been transmitted to EV), the latest follow-up report or a master report created by the Agency out of two or more detected duplicates.

- **Duplicate** – a case report (see I.C.6) which has been detected as a duplicate and merged under a master report by the Agency.
- **Invalid** – a replaced or nullified report (see I.C.6)

### ***I.C.6.2 Classification of Medicinal Product Information***

The ICH E2B(R3) implementation guide and the business rules provided in section I.C.4 allows for organisation to use free text when reporting drug information. Although the use of controlled vocabularies is preferred, until such a time as the ISO IDMP standards are implemented worldwide the support for free text will be required.

In order to allow accurate searching and retrieval of ICSRs the free text drug information within an ICSR message will be classified against medicinal product information available to the EMA in line with the decision tree provided in section I.C.3.6.1..Table 40 below provides a list of the free text medicinal product fields that will be used as the basis for classifying ICSRs using a medicinal product controlled vocabulary to complete the structured medicinal product information fields.

**Table 40 - Free text medicinal product fields subject to classification c**

<b>ICH E2B(R3) field code</b>	<b>ICH E2B(R3) field Description</b>
D.8.r.1	Name of Drug as Reported
D.8.r.EU.r.1	Substance / Specified Substance Name
D.10.8.r.1	Name of Drug as Reported
D.10.8.r.EU.r.1	Substance / Specified Substance Name
G.k.2.2	Medicinal Product Name as Reported by the Primary Source
G.k.2.2.EU.9.r.1	Device Component name (free text)
G.k.2.3.r.1	Substance / Specified Substance Name

The coding of medicinal product information will be carried out in the same was as described in section I.C.3.6.1 for the ISO IDMP fields. The XML snippet in

**Figure 24** below shows how classified information will be entered in the XML file where only the free text medicinal product name (*Medicinal Product Name as Reported by the Primary Source*) or substance name was provided and the code fields were left blank by the sender.

**Figure 24 – XML snippet for classified medicinal product information**

```
<code code="4" codeSystem="2.16.840.1.113883.3.989.2.1.1.20"
displayName="drugInformation"/>
  <component typeCode="COMP">
    <substanceAdministration classCode="SBADM" moodCode="EVN">
      <id root="3c91b4d5-e039-4a7a-9c30-67671b0ef9e4"/>
      <consumable typeCode="CSM">
        <instanceOfKind classCode="INST">
          <kindOfProduct classCode="MMAT" determinerCode="KIND">

<-- The classified information will be provided in the attribute field "code" as shown below, and the
coding system used e.g. ISO MPID, PhPID will be provided in the codesystem attribute -->

<code code="GB-XYZ Pharma-13456" codeSystem="EU.OID.MPID" codeSystemVersion="1"/>

<--Free text medicinal product name as provided by the sender is given in the element below -->

      <name>Fastaction FlexPen 100 IU/ml Solution for injection</name>
```

### **I.C.6.2.1 Classification of medicinal products in the interim period before ISO IDMP is available**

Before the implementation of ISO IDMP, medicinal products will be classified against XEVMPD data. The following XML snippet in Figure 25 below shows how the classified information will appear for when exporting ICSRs in XML E2B(R3) format from EudraVigilance when Level 2A/2B or Level 3 access rights in accordance with the [EudraVigilance Access policy applies](#).

**Figure 25 – XML snippet for classified medicinal product information**

```

<code code="4" codeSystem="2.16.840.1.113883.3.989.2.1.1.20"
displayName="drugInformation"/>
  <component typeCode="COMP">
    <substanceAdministration classCode="SBADM" moodCode="EVN">
      <id root="3c91b4d5-e039-4a7a-9c30-67671b0ef9e4"/>
      <consumable typeCode="CSM">
        <instanceOfKind classCode="INST">
          <kindOfProduct classCode="MMAT" determinerCode="KIND">

<-- The classified information will be provided in the attribute field "code" as shown below, and the
coding system "PIX-code" will be provided in the codesystem attribute. The displayName attribute
contains the classified product/substance name-->

<code code="PIX123434" codeSystem="PIX-code" codeSystemVersion="1"
displayName="IBUPROFEN 500mg tablets"/>

<--Free text medicinal product name as provided by the sender is given in the element below -->

  <name>500mg Ibuprofen tabs</name>

```

## I.D Appendix

### I.D.1 Electronic Data Interchange Definitions

The definitions that are described in this chapter are the general definitions used in this document for Electronic Data Interchange.

Selected terminology as defined in the frame of the International Council on Harmonisation of Technical Requirements for Registration of Pharmaceuticals for Human Use has been included with particular emphasis on the type of format (XML), information (reports) and messages (safety and acknowledgment messages) used in the EDI process in the area of pharmacovigilance in the pre- and post-authorisation phase. As there are different types of acknowledgement of receipt of an EDI message, it is clearly indicated which level of acknowledgement is referred to, in order to avoid confusion.

For the purpose of this Note for Guidance, the following terms are defined as:

#### **EDI:**

Electronic Data Interchange is the electronic transfer, from computer to computer, of commercial and administrative data using an agreed standard to structure an EDI message. EDI is based on the use of structured and coded messages, the main characteristic of which is their ability to be processed by computers and transmitted automatically and without ambiguity. This makes EDI specific in comparison with other data exchange such as electronic mail.

#### **EDI Message:**

An EDI Message consists of a set of segments, structured using an agreed standard, prepared in a computer readable format and capable of being automatically and unambiguously processed.

#### **Gateway:**

A Gateway is defined as a data exchange service, which consists of all core standards and functionality required for supporting the standards of the International Council on Harmonisation of Technical Requirements for Registration of Pharmaceuticals for Human Use (ICH) (e.g. Simple Mail Transfer Protocol/Secure Multipurpose Internet Mail Extension -SMTP/SMIME- protocol).

#### **Message Disposition Notification (MDN):**

The MDN is a notification on the receipt of an EDI Message returned by the Receiver's Gateway to the Sender's Gateway. The MDN concludes a Message Transaction performed between two parties in a Gateway to Gateway communication.

**EDI Partner:**

An organisation exchanging EDI Messages in the area of pharmacovigilance in the pre- and post-authorisation phase with another organisation. For the purpose of this Note for Guidance EDI partners in the pre- and post-authorisation phase in pharmacovigilance are as follows:

- Competent Authorities in the EEA
- Marketing Authorisation Holders in the EEA
- Applicants
- Sponsors in the EEA

**Sender:**

The Sender is the person or entity creating an EDI Message for transmission.

**Receiver:**

The Receiver is the intended recipient of the EDI Message.

**Report Sender:**

The Report Sender is the person or entity creating a Safety Message as EDI Message in order to submit a Safety Report, which for the purpose of this Note for Guidance is an EDI Partner. In the Report Transaction the Report Sender will always remain the same, whereas with the exchange of messages the "Sender" and "Receiver" roles will change (see graph in Annex I).

**Report Receiver:**

The Receiver is the intended recipient of the transmission of a Safety Message, which for the purpose of this Note for Guidance is an EDI Partner

**Sender Identifier (Sender ID):**

The Sender Identifier is the identification (ID) or combined EDI qualifier and ID of the Sender.

**Receiver Identifier (Receiver ID):**

The Receiver Identifier is the identification or combined EDI qualifier and ID of the recipient.

**Message Transaction:**

A Message Transaction is a set of actions encompassing the electronic transmission of an EDI Message (Safety Message or Acknowledgement Message,) between a Sender and a Receiver including the return of the Message Disposition Notification for that message.

**Safety Message:**

A Safety Message is an EDI Message including the information provided for one/more Individual Case Safety Reports contained in one Safety File exchanged between one Sender and one Receiver in one Message Transaction.

**Safety File:**

The Safety File is the electronic file transmitted in one Message Transaction between one Sender and one Receiver containing one Safety Message.



**Individual Case:**

An Individual Case is the information provided by a primary source to describe suspected adverse reaction(s)/suspected unexpected serious adverse reactions related to the administration of one or more medicinal products/investigational medicinal products to an individual patient at a particular point of time.

**Individual Case Safety Report (ICSR):**

An Individual Case Safety Report is a document providing the most complete information related to an Individual Case at a certain point of time. An ICSR may also be referred to as Safety Report.

**Acknowledgement of Receipt:**

The Acknowledgement of Receipt is the procedure by which on receipt of the Safety Message the syntax and semantics are checked.

**Acknowledgement Message (ICSRACK):**

The Acknowledgement Message is an EDI Message with the information on the result of the Acknowledgement of Receipt procedure to acknowledge the receipt of one Safety Message and the Safety Report(s) contained in the Safety File.

**Report Transaction:**

A Report Transaction is the complete set of actions in the electronic reporting of Safety Messages to comply with regulatory requirements which routinely include the following:

- Creation of a Safety Message;
- Transmission of the Safety Message to the Report Receiver;
- On receipt of the Safety Message by the Receiver's Gateway return of an MDN;
- This MDN will be referred to as ICSR-MDN;
- The ICSR-MDN is received and stored by the Report Sender to document the success of the Safety Message transmission;
- The Safety Message is subjected to the Acknowledgement of Receipt procedure by the Report Receiver;
- The Acknowledgement Message is created;
- The Acknowledgement Message is returned to the Report Sender (technically the Report Receiver is a Message Sender for this part of the transaction);
- On receipt of the Acknowledgement Message by the Report Sender's Gateway return of an MDN;
- This MDN is referred to as ICSRACK-MDN;
- The ICSRACK-MDN is received and stored by the Report Receiver to document the successful transmission of the Acknowledgement Message;
- The Acknowledgement Message is evaluated to document the success of the Report Transaction.

**Competent Authorities:**

An authority within the EEA including the EMA and the European Commission responsible for the granting of marketing authorisations for medicinal products and the supervision of marketing of such products in accordance with the relevant laws and regulations established under EU law.

An authority within the EEA responsible for granting the authorisation to conduct a clinical trial in at least one Centre located with the EU in accordance with the relevant laws and regulations established under EU law.

**Marketing Authorisation Holders:**

All Marketing Authorisation Holders (MAHs) holding a valid marketing authorisation for a medicinal product in the EEA including any part thereof, independent of the authorisation procedure of this medicinal product.

**Applicant:**

An applicant is a pharmaceutical company applying for a marketing authorisation in the EEA.

**Sponsor:**

An individual, company, institution or organization, which takes responsibility for the initiation, management and/or financing of a clinical trial.

**XML:**

Extensible Markup Language (XML) is a subset of the International Standard (ISO 8879) called Standard Generalized Markup Language (SGML)

**The Gateway:**

The Gateway is the data-processing network as defined in the EU legislation and is providing a single point of contact between MAHs, Applicants, Sponsors and Competent Authorities in the EEA. By doing so, the Gateway is considered a hub and all connections to the EDI Partners are known as spokes. Safety and Acknowledgement Messages are routed through the hub to the desired spoke.

## I.D.2 Schema of ICSR Report Transactions using Gateway

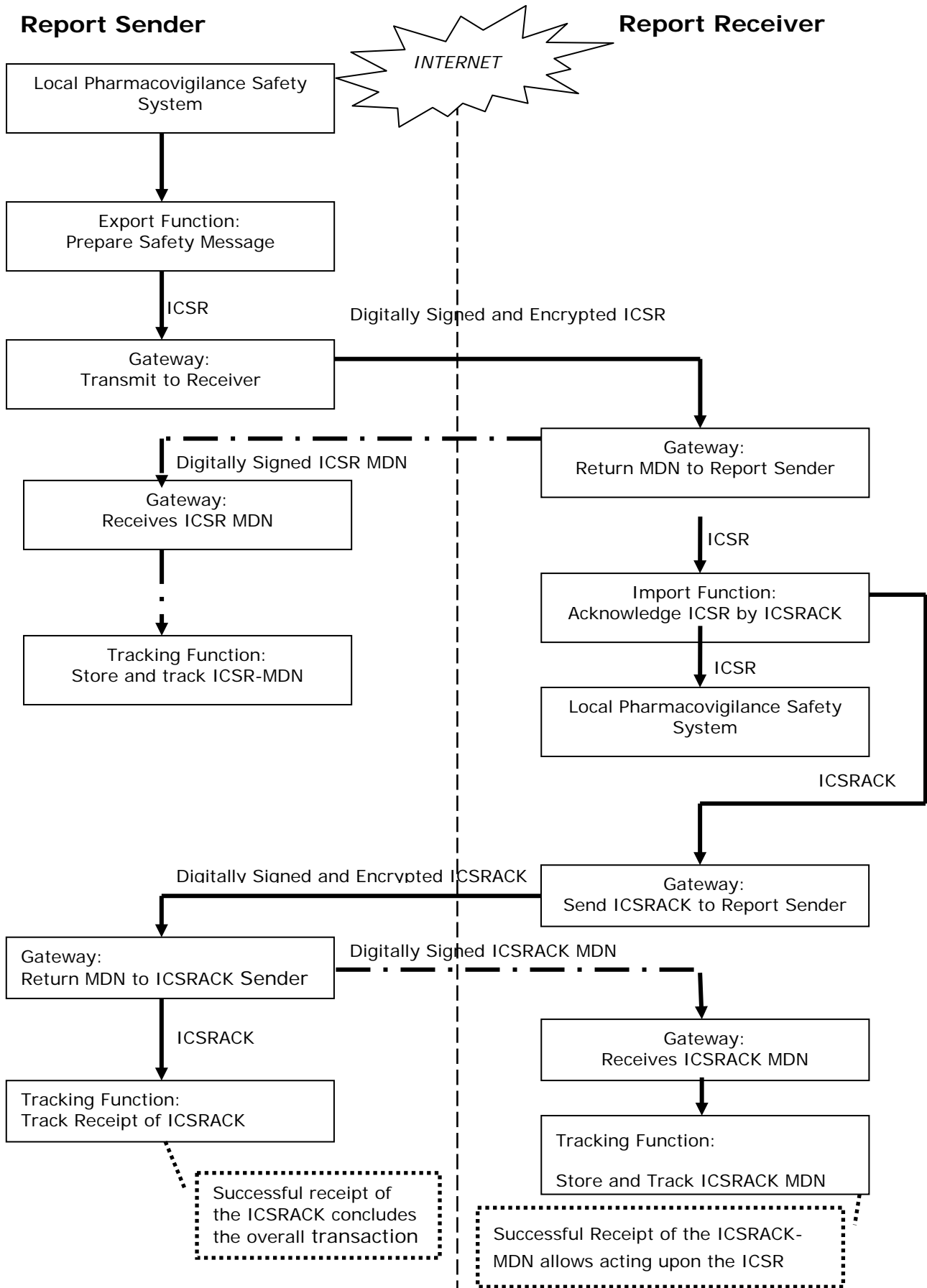

### I.D.3 Schema of ICSR Report Transactions using WebTrader

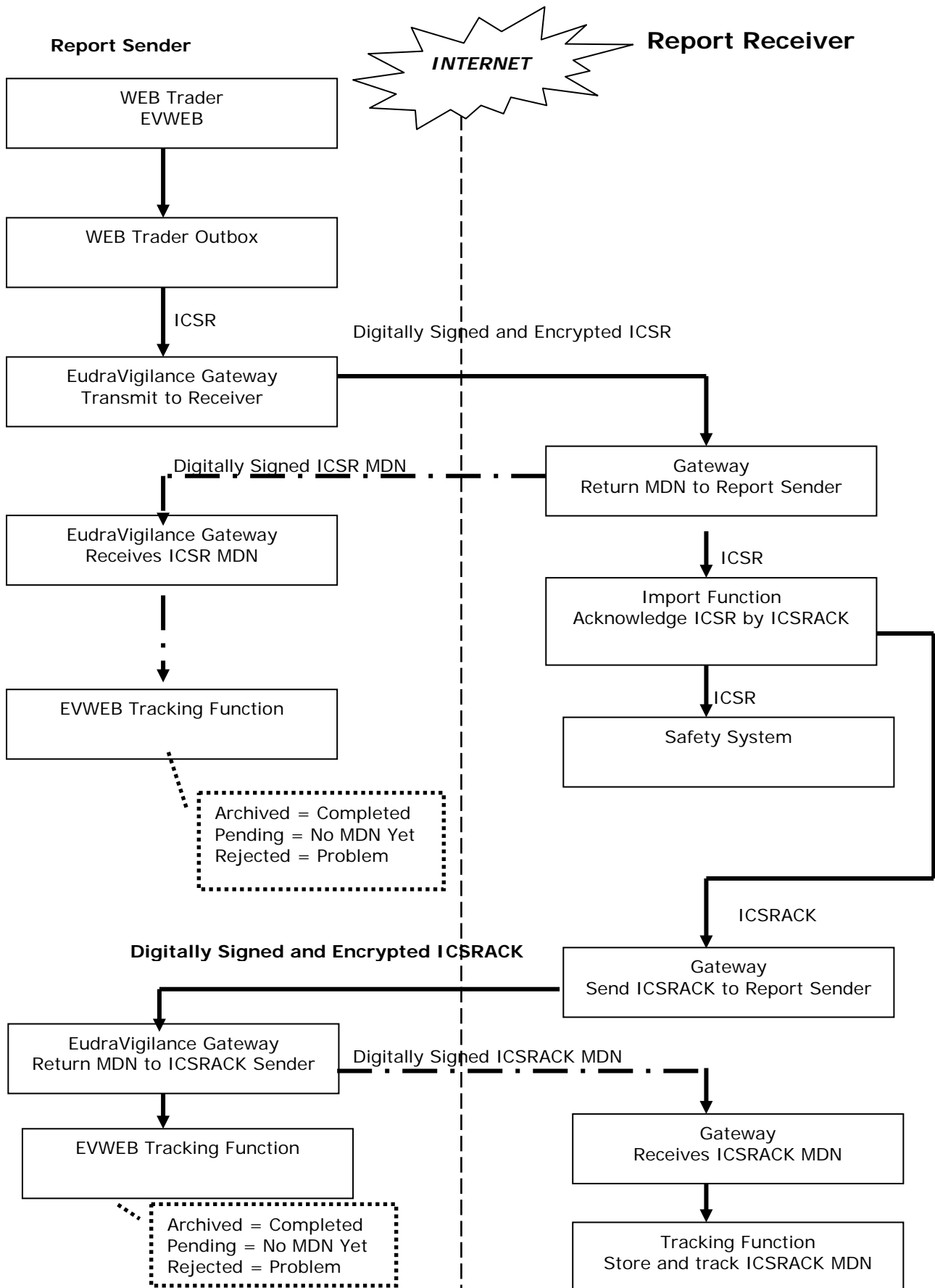

## **I.D.4 Rerouting of ICH E2B(R2) Messages**

The ICSR format forwarded on to National Competent Authorities (NCAs) will be the same as the original format received. ICSR messages received in E2B(R2) format will be forwarded to NCAs in E2B(R2) format, the specific technical information on this process is provided in the sections below.

For the rerouting of ICH E2B(R3) ICSR messages the specifications and rules provided above in section I.C.2.2 will be followed. In addition the master and classified ICSRs will only be made available in E2B(R3) format.

### ***I.D.4.1 Rerouting timeframes for ICH E2B(R2) Messages***

The following technical aspects will apply to ICH E2B(R2) messages received by the EMA that are required to be forwarded to concerned NCAs

The EMA will automatically forward on without delay copies of the valid post-authorisation ICSR and Clinical Trial SUSARs received into EudraVigilance to National Competent Authorities that have requested to receive them. ICSRs that have parsing errors and ICSRs that contain errors resulting in the ICH E2B(R2) ICSR Acknowledgement Code (B.1.8) "02" will not be forwarded to NCAs. Original cases received from an NCA will be excluded from being retransmitted back to the sending NCA.

Save for periods of planned downtime of the EudraVigilance system the following timeframes will apply to the forwarding of valid ICSR:

- 95% of valid ICSRs will be re-routed to the relevant NCAs within 12 hours of receipt by the EV Gateway
- 99% of valid ICSRs received during EMA office hours will be re-routed to the relevant NCAs within 24 hours of receipt by the EV Gateway
- 99.9% of valid ICSRs will be re-routed to the relevant NCAs within 48 hours of receipt by the EV Gateway

NCAs should return acknowledgements for rerouted ICSRs within 48 hours of the initial receipt. If no acknowledgement is received within 48 hours, EudraVigilance will automatically resubmit the re-routed ICSRs. For resubmitted ICSRs NCAs should return acknowledgements within 24 hours. EudraVigilance will make a maximum of three attempts to resubmit ICSRs when no acknowledgement has been returned by an NCA. After the maximum number of attempts has been reached the NCA concerned will be contact by the EMA in order to understand if the NCA is experiencing technical issues. I.D.4.1.1 Retransmission rules for post-authorisation E2B(R2) ICSRs

NCAs will provide and maintain a list of ISO 3166 country codes for which they wish to receive copies of ICSRs that have been entered in to EudraVigilance. An option to receive only serious ICSRs or all ICSRs will also be included.

The ICH E2B(R2) field *Identification of the country of primary source* (A.1.1) will be used to identify the National Competent Authority requesting that ICSR in accordance with the list of ISO 3166 country codes described above.

If the ICH E2B(R2) field Serious (A.1.5) is set to "yes" in an ICSR the case will be considered serious and forwarded to an NCA that has specified that they only wish to receive serious cases. The above check will not be performed for NCAs that have requested to receive both serious and non-serious cases.

The fields that will be changed when retransmitting ICSRs will be shown in Table 41 below. The Message type (M.1.1) for the retransmission of ICSRs as received from the sending organisation will be "ichicsr".

Table 41 - Fields changed upon retransmission

ICH E2B(R2) field code	ICH E2B(R3) field Description	Notes
M.1.4	Message Number	
M.1.5	Message Sender Identifier	Will be set to "EVHUMAN"
M.1.6	Message Receiver Identifier	Will be set to the receiving NCA gateway identifier
M.1.7b	Message date	
A.3.1.2	Sender Identifier	Will be set to the Message sender Identifier (M.1.5) of the ICSR message as received by EudraVigilance

Cases submitted by NCAs to EudraVigilance will not be retransmitted back to the sending NCA, this check will be based on the sending organisation's *Message Sender Identifier* (M.1.5).

#### I.D.4.1.2 Retransmission rules for Clinical Trial E2B(R2) SUSARs

NCAs will provide and maintain a list of ISO 3166 country codes for which they wish to receive copies of SUSARs that have been entered in to EudraVigilance. NCAs can opt out of receiving re-routed SUSARs. NCAs will also be able to request to receive SUSARs classified by the EMA, see section I.C.2.2 for further details.

The ICH E2B(R2) field *Identification of the country of primary source* (A.1.1) will be used to identify the National Competent Authority requesting that ICSR in accordance with the list of ISO 3166 country codes described above.

In addition, NCAs can choose to receive the following SUSARs originating from within the EEA that were not forwarded due to the above country code list by selecting one of either of the following:

- Receive the SUSARs if the Clinical trial unique number (equivalent to EudraCT number) quoted in the SUSAR is the same as a Clinical trial unique number of a trial authorised by the NCA.
- Receive the SUSAR if one of the substances that has been reported as a suspect drug in the SUSAR has been approved by that NCA for use in a current clinical trial. Note: these cases cannot not be successfully retransmitted until classification of the reported substances has been completed.

If the SUSAR is from outside of the EEA the NCA can also choose one of the following options to receive these cases:

- Receive the SUSARs if the Clinical trial unique number (equivalent to EudraCT number) quoted in the SUSAR is the same as a Clinical trial unique number of a trial authorised by the NCA.
- Receive the SUSAR if one of the substances that has been reported as a suspect drug in the SUSAR has been approved by that NCA for use in a current clinical trial. Note: these cases cannot not be successfully retransmitted until classification of the reported substances has been completed.

The fields that will be changed when retransmitting ICSRs will be shown in Table 42 below. The Message type (M.1.1) for the retransmission of ICSRs as received from the sending organisation will be "ichicsr".

**Table 42 - Fields changed upon retransmission**

ICH E2B(R2) field code	ICH E2B(R3) field Description	Notes
M.1.4	Message Number	
M.1.5	Message Sender Identifier	Will be set to "EVCTMPROD"
M.1.6	Message Receiver Identifier	Will be set to the receiving NCA gateway identifier
M.1.7b	Message date	
A.3.1.2	Sender Identifier	Will be set to the Message sender Identifier (M.1.5) of the ICSR message as received by EudraVigilance

Cases submitted by NCAs to EudraVigilance will not be retransmitted back to the sending NCA, this check will be based on the sending organisation's *Message Sender Identifier* (M.1.5).

#### **I.D.4.1.3 Transmission of E2B(R2) ICSRs entered into EudraVigilance by the EMA**

The EMA is required to perform the monitoring for literature articles for a defined list of substances and medical journals. ICSRs that are identified during this activity will be entered into EudraVigilance by the EMA initially these will be provided as E2B(R2) XML files until E2B(R3) XML is implemented for data entry. These will be forwarded to NCAs following the same rules as described in section I.D.4.1.1 above.